

TECHCONNECT TC2-HDMIW20

OWNERS MANUAL



www.visionaudiovisual.com/techconnect/tc2-hdmiw20

DECLARATION OF CONFORMITY

Where applicable Vision products are certified and comply with all known local regulations to a 'CB Certification' standard. Vision commits to ensure all products are fully compliant with all applicable certification standards for sale in the EU and other participating countries.

The product described in this owner manual is in compliance with RoHS (EU directive 2002/95/EC), and WEEE (EU directive 2002/96/EC) standards. This product should be returned to the place of purchase at the end of its useful life for recycling.

WARNINGS



CAUTION
RISK OF ELECTRIC SHOCK
DO NOT OPEN



CAUTION: TO REDUCE THE RISK OF ELECTRIC SHOCK DO NOT REMOVE COVER (OR BACK). NO USER-SERVICEABLE PARTS INSIDE. REFER SERVICING TO QUALIFIED SERVICE PERSONNEL.

 The lightning flash with arrowhead symbol, within an equilateral triangle, is intended to alert the user to the presence of uninsulated "dangerous voltage" within the product's enclosure that may be of sufficient magnitude to constitute a risk of electric shock to persons.

 The exclamation point within an equilateral triangle, is intended to alert the user to the presence of important operating and maintenance (servicing) instructions in the literature accompanying the appliance.

WARNING: TO REDUCE THE RISK OF FIRE OR ELECTRIC SHOCK, DO NOT EXPOSE THIS APPLIANCE TO RAIN OR MOISTURE.

All products are designed and imported into the EU by 'Vision' who is wholly owned by 'Azlan Logistics Ltd.', Registered in England Nr. 04625566 at Lion House, 4 Pioneer Business Park, Clifton Moor, York, YO30 4GH. WEEE Registration: GD0046SY



DECLARATION OF ORIGIN

All Vision products are made in the People's Republic of China (PRC).

USE ONLY DOMESTIC AC OUTLETS

Connecting the unit to an outlet supplying a higher voltage may create a fire hazard.

HANDLE THE POWER CORD WITH CARE

Do not disconnect the plug from the AC outlet by pulling the cord; always pull the plug itself. Pulling the cord may damage it. If you do not intend to use your unit for any considerable length of time, unplug the unit. Do not place furniture or other heavy objects on the cord, and try to avoid dropping heavy objects on it. Do not tie a knot in the power cord. Not only could the cord be damaged, but a short circuit could also be caused with a consequent fire hazard.

PLACE OF INSTALLATION

Avoid installing this product under the following conditions:

- Moist or humid places
- Places exposed to direct sunlight or close to heating equipment
- Extremely cold locations
- Places subject to excessive vibration or dust
- Poorly ventilated places

Do not expose this product to dripping or splashing. **DO NOT PLACE OBJECTS FILLED WITH LIQUIDS ON OR NEAR THIS PRODUCT!**

MOVING THE UNIT

Before moving the unit, be sure to pull out the power cord from the AC outlet and disconnect the interconnection cords with other units.

WARNING SIGNS

If you detect an abnormal smell or smoke, turn this product off immediately and unplug the power cord. Contact your reseller or Vision.

PACKAGING

Save all packing material. It is essential for shipping in the event the unit ever needs repair.

IF ORIGINAL PACKAGING IS NOT USED TO RETURN THE UNIT TO THE SERVICE CENTRE, DAMAGE IN TRANSIT WILL NOT BE COVERED BY WARRANTY.

TRADEMARK

HDMI, the HDMI Logo and High-Definition Multimedia Interface are trademarks of HDMI Licensing LLC.

SPECIAL WARNINGS

Never use this product near an aircraft or medical facility. It can cause interference.

Use of product in the following locations may result in abnormal video and audio output:

- Product installed in the walls made of concrete
- Product situated near refrigerator, Microwave oven, or other metal items
- A cluttered room where the wireless signals may be blocked

This product has been tested and manufactured to comply with each country's safety rules, however there is no guarantee that interference will not occur in some scenarios. If interference happens, adjust distance between transmitter and receiver. Optimal range between transmitter and receiver is between 2 and 7 meters line of sight.

This product may interfere 5GHz wireless devices. If interference occurs configure your 5GHz router to 2.4 GHz band only.

FEDERAL COMMUNICATIONS COMMISSION INTERFERENCE STATEMENT

This equipment has been tested and found to comply with the limits for a Class B digital device, pursuant to Part 15 of the FCC Rules. This equipment generates, uses and can radiate radio frequency energy and may in extreme cases cause harmful interference to radio communications. If this happens the user should try:

- Relocating the receiving antenna
- Increasing the separation between the equipment and receiver
- Connect the equipment to a different power circuit.

RADIATION EXPOSURE STATEMENT:

This equipment complies with IC radiation exposure limits set forth for an uncontrolled environment. This equipment should be installed and operated with minimum distance 20cm between the radiator and your body.

INTRODUCTION

This product transmits uncompressed 1080p (60 Hz) video and audio content to a display wirelessly. It uses 4.9 GHz~ 5.9 GHz frequencies and it adjusts frequency automatically to avoid interference. It has built-in Omni-directional antennas and transmits up to 20 meters (66 feet) LOS (Line of sight) with no latency.

TRANSMITTER ("Tx")

1. Current Source indicator
2. Source select button
3. Power standby button (blue = on / red = off / purple = Tx on Rx off)



4. Power Input (5V/2A/10W with 3.5x1.35 round connector)
5. HDMI Inputs (type A)
6. HDMI loop-through Output (type A) (source select affects this output. Only active when Tx powered on)
7. IR OUT plug IR blaster cable in here

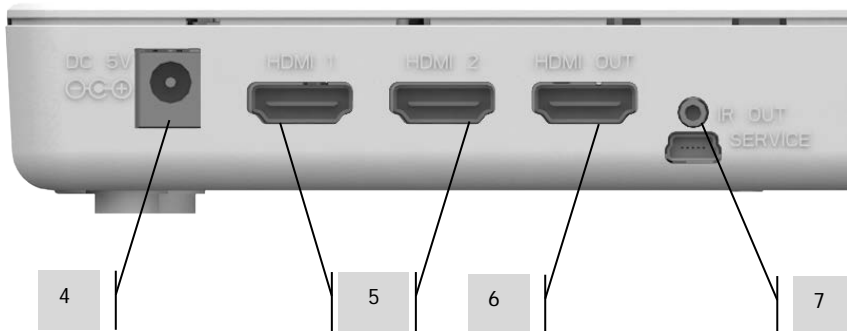

RECEIVER ("Rx")

1. Mini-USB power input (5V/2A/10W)
2. HDMI output (type A)
3. Current Source indicator
4. Source select button
5. Power Button (blue when on, red when in standby)

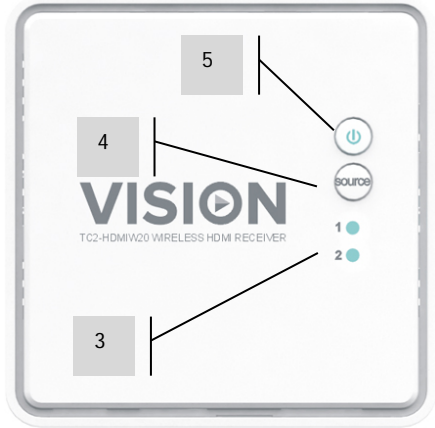
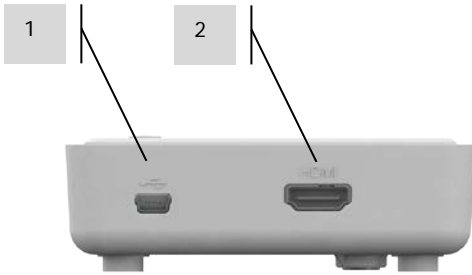

REMOTE CONTROL

1. Power Button
2. IR button (toggles IR blaster frequency 38/47/56kHz to match source device frequency. The default setting is 47kHz. On screen display shows current frequency)
3. INFO button (press to show onscreen diagnostics information. Press again to turn off)
4. Source select button

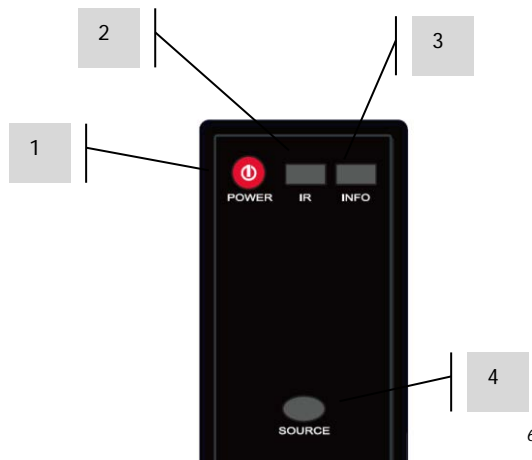

WALL MOUNTING

The Tx and Rx can be wall mounted.

DRY WALL INSTRUCTIONS:

1. DRILL 2 X HOLES IN WALL
2. INSERT PLASTIC RAWL PLUGS INTO HOLES
3. INSERT SCREWS INTO PLUGS. LEAVE HEADS PROTRUDING
4. HOOK INTO PLACE

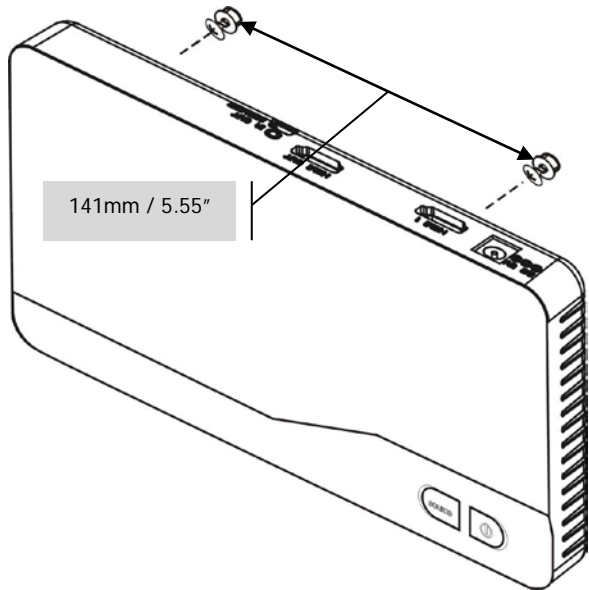
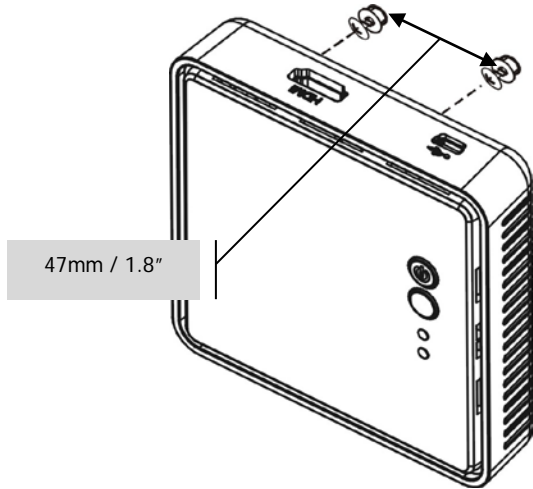

INSTALLATION

Connecting Rx

1. PLUG IN TO POWER
2. CONNECT TO DISPLAY with included HDMI cable
3. TURN DISPLAY ON and select correct input

Connecting Tx

1. CONNECT INPUTS from source devices
2. [OPTIONAL] CONNECT OUTPUT to local display if there is one
3. PLUG IN TO POWER power button backlight changes from red to blue

When the Tx is powered on the Rx will automatically come out of standby. If the transmitter is powered off the receiver will switch to Standby after 10 minutes automatically.

Connecting IR Blasters

It is possible to point your source remote control at the Rx, and it will relay the IR signal back to the source/s wirelessly.

1. CONNECT IR EMITTER TO TX Cable has 3 x IR emitter diodes inline to control up to three source devices. Position them directly over the IR receivers on the source equipment.

NOTE 1: The IR sensors support 36~56kHz (NEC, RC5, RC6) signal protocol. The default setting is 47kHz. Some devices may not be supported.

OPERATION

1. CHECK REMOTE CONTROL Ensure the 2 x AAA batteries are loaded into the remote control.
2. TURN POWER ON When mains power is turned on the Tx and Rx will automatically turn on.
 - They can be powered on in any order
 - If both in standby both need to be turned on manually
3. TURN POWER OFF
 - Pressing Rx or Remote control power button turns Rx off, but leaves Tx on so that the pass-through on Tx continues to work.



- Pressing Tx power button will turn both off.



As soon as they are both on the blue power light will flash for 15-20 seconds while the link is established, then it will stay on.

NOT WORKING?

If you don't have an image ensure:

1. Even when there is no link an on screen display will be output from the receiver.
2. The computer is set to duplicate or extend the desktop (Control Panel\Appearance and Personalisation\Display\Screen Resolution)
3. Change source on Tx

INFO

Press INFO button on remote control to see on screen display:

- Signal Quality
- Source
- Channel
- Resolution

NOTE: The status of the Tx HDMI output cannot be displayed on the on screen display.

Press INFO button again to turn on screen display off.

STATUS INDICATORS

		Rx Power LED	Rx Status LED	Rx OSD Display
Standby	Power saving	Solid Red	off	
Boot up	15~20 seconds for system boot up.	Flashing Blue	Flashing	
Searching available channels	If system can't establish link over 80s after initialization.	Flashing Blue	Flashing	
Wireless linked Mode	No input from selected source	Solid Blue	Flashing (Quickly)	
	Video format not recognized	Solid Blue	Flashing (Slowly)	
	Video format recognized	Solid Blue	Solid Blue	-

NOTE 1: If link does not establish the transmitter may be out of range. Adjust distance between Tx and Rx. The maximum video transmission range for 1080p content is up to 20m (66 feet) in line of sight (LOS). The minimum range is 2m (6.5 feet).

NOTE 3: If no video displayed and on screen display says "Not Supported Format" adjust resolution and frame rate on source device.

SUPPORTED RESOLUTIONS

Supported Resolutions	Resolution
640x480p @ 59.94 / 60Hz	480p
720x480p @ 59.94Hz	
720x480p @ 60Hz	
720x576p @ 50Hz	576p
1280x720p @ 50Hz	720p
1280x720p @ 59.94 / 60Hz	
1920x1080i @ 50Hz	1080i
1920x1080i @ 59.94 / 60Hz	
1920x1080p @ 50Hz	1080p / 60
1920x1080p @ 59.94 / 60Hz	
1920x1080p @ 23.98 / 24Hz	1080p / 24
1920x1080p @ 25Hz	
1920x1080p @ 29.97 / 30Hz	
640x480 @ 59.94 / 72.809Hz (DVi only)	VGA
800x600 @ 60.317 / 72.188Hz (DVi only)	SVGA
1024x768 @ 60 / 70.069Hz (DVi only)	XGA
1280x768 @ 60 Hz (DVi only)	WXGA
1280x1024 @ 60 Hz (DVi only)	SXGA
1600x1200 @ 60 Hz (DVi only)	UXGA

If Tx LED continues to flash slower than “no signal” mode), and there is no video or video is poor, then the resolution is not supported.

Supported Mandatory CEA 3D Video Format Timings
1280x720p @ 50Hz Top-and-Bottom
1280x720p @ 50Hz Frame packing
1280x720p @ 59.94 / 60Hz Top-and-Bottom
1280x720p @ 59.94 / 60Hz Frame packing
1920x1080i @ 50Hz Side-by-Side (Half)
1920x1080i @ 59.94 / 60Hz Side-by-Side (Half)
1920x1080p @ 23.98 / 24Hz Top-and-Bottom
1920x1080p @ 23.98 / 24Hz Frame packing

If the RX status LED continues to flash slower than “no signal” mode or on screen display shows



check if display supports 3D format. Try switching the 3D video format on the source.





SUPPORTED AUDIO BIT RATES

- Digital Audio from HDMI inputs: Up to 6Mbit/s bit-rate
- Supports AC3 and DTS
- Supports 2-channel PCM audio: 16~24 bits audio sample with 32~96KHz sampling rate

2-channel PCM	32KHz	44.1KHz	48KHz	96KHz
16 bits	YES	YES	YES	YES
24 bits	YES	YES	YES	YES

TROUBLESHOOTING

If your system is not operating properly, please refer to the following information.

Problem	Correction
Power indicators not lighting up	<ul style="list-style-type: none"> • Check if the power plugs of transmitter/receiver are properly inserted into a functioning power outlet.
No video displayed on display	<p>First steps</p> <ul style="list-style-type: none"> • Check the HDMI connection on the Tx • Check the HDMI cable on the RX • Select the HDMI as input source on source • Check the POWER and INFO lights on Rx <p>Power LED flashing blue</p> <p>OSD displayed  (4 levels looping)</p> <ul style="list-style-type: none"> • Ensure the transmission range is correct. <p>POWER LED solid blue + slow flashing SOURCE LED</p> <p>OSD displayed  </p> <ul style="list-style-type: none"> • Check video resolution and frame rate on source and adjust. • Connect source directly to display to check it works. <p>POWER LED solid blue + STATUS LED flashing quickly</p> <p>OSD displayed  </p> <ul style="list-style-type: none"> • Tx is plugged in to source device properly and powered on. • Check display setting for your PC have been set to clone mode, Projector out mode or dual display mode to enable external display.

<p>Poor image quality or intermittent video</p>	<ul style="list-style-type: none"> • Check video resolution on source device is compatible • Ensure the transmission distance is less than 20m (66 feet) line of sight
<p>No audio</p>	<ul style="list-style-type: none"> • Check audio system is not muted and correct input is selected • Check PC audio settings to ensure output is set to HDMI out • Check PC audio volume • Ensure bit rate of audio from the source device can be supported
<p>No audio and/or video when PC resuming from sleep.</p>	<ul style="list-style-type: none"> • Try re-connecting Tx • Reboot Tx to re-synchronize the display setting • Please try to reboot your PC (or laptop)
<p>IR Blaster not controlling source</p>	<ul style="list-style-type: none"> • Check location of IR emitter. It should be line-of-sight of receiver on source device. • Press IR button on remote to change frequency
<p>No 3D video output</p>	<p>OSD displayed :</p> <p>RX </p> <ul style="list-style-type: none"> • Check the display supports 3D • If Rx is connected to AV Receiver check it supports 3D • Check the video output setting of Source • 3D video format not supported. Switch 3D video format to HDMI 1.4a mandatory 3D format.

SPECIFICATIONS

TRANSMITTER DIMENSIONS: 182 x 97 x 32 mm / 7.2" x 3.8" x 1.3"(length x width x height)

RECEIVER DIMENSIONS: 95 x 95 x 32 mm / 3.7" x 3.7" x 1.3" (length x width x height)

PRODUCT WEIGHT: 400 g / ,88 lbs (set)

CONSTRUCTION MATERIAL: Plastic

COLOUR: White

TECHNICAL DETAILS:

Maximum Video Format Supported: 1920x1200 / 1080P @ 60Hz 3D

Data transfer rate 40 Mhz channel: 3Gbps (1080P @ 60Hz)

Data transfer rate 20 Mhz channel: 1.5Gbps (1080P @ 30Hz)

Video: HDMI 1.3 with HDCP 1.2

Audio: Up to 6 Mbps AC3 and DTS, 2 Channel PCM @ 24 bits up to 96kHz

Operating Temperature Range: 0-40°C

Operating Humidity Range: < 80 % RH (no condensation)

Transmitter Power Consumption: 10 watts

Receiver Power Consumption: 7.5 watts

Latency: < 1ms

Maximum distance: 20 m (66 feet)

Encryption: 128 bit AES

TRANSMITTER CONNECTIVITY:

2 x HDMI (type A) inputs

1 x HDMI (type A) output

1 x IR OUT Minijack

1 x DC power (round pin type)

RECEIVER CONNECTIVITY:

1 x HDMI (type A) output

1 x DC Power (Mini USB-B)

TRANSMITTER POWER SUPPLY: 100-240v AC 50/60Hz 5 volt / 2 amp / 10 watt. DC cable hard-wired to transformer with round power connector.

Transformer integrated into plug. Includes interchangeable plugs: UK/EU/US/AU. DC tail length: 1.2 m. Transformer dimensions: 64 x 41 x 33 mm / 2,5" x 1,6" x 1,3"

RECEIVER POWER SUPPLY: 100-240v AC 50/60Hz 5 volt / 2 amp / 10 watt. USB-A socket.

Transformer integrated into plug. Includes interchangeable plugs: UK/EU/US/AU. Transformer dimensions: 64 x 41 x 33 mm / 2,5" x 1,6" x 1,3"

ACCESSORIES INCLUDED:

1 x USB-A to 1.35 round pin cable 1.0 m (3.3 ft) for transmitter PSU (black)

1 x USB-A to mini-USB-B cable 450 mm (18") for receiver PSU (black)

1 x Remote Control with 2 x AAA batteries included (black)

1 x IR Emitter cable 1.5 m (4.9 ft) – three diodes (black) for transmitter

1 x HDMI Cable 1.5 m / 4.9 ft (black)

WARRANTY: 2-year return to base

COMPLIANCES: RoHS, WEEE, CE/EMC

ORDER PART CODE: TC2-HDMIW20 [SAP: 3223893]

WARRANTY

This product comes with a 2-year return to base warranty, effective from the date of purchase. This warranty applies only to the original purchaser and is not transferable. For the avoidance of doubt, this will be taken from the information held by the appointed national distributor at the point of sale. If the product is DOA (dead on arrival), you have 21 days from purchase date to notify the national distributor via your AV reseller. The liability of the manufacturer and its appointed service company is limited to the cost of repair and/or replacement of the faulty unit under warranty, except for death or injury (EU85/374/EEC). This warranty protects you against the following:

- Failure of any components, including the power supply.
- Damage when the product is first removed from its packaging if reported within 24 hours of purchase.

If you find you do have a problem with this product, you should contact the AV reseller you purchased this product from. The original purchaser is responsible for shipment of the product to the manufacturer's appointed service centre for repair.

We will endeavour to return repaired units within 5 working days, however this may not always be possible, in which case it will be returned as soon as practicably possible. In line with our WEEE commitments, the manufacturer endeavours to replace the faulty parts of the product rather than replacing the whole unit. This warranty does not protect this product against faults caused by abuse, misuse, incorrect installation, unstable or faulty power input, which might be caused by ignoring the guidelines set out in this manual.

LEGAL DISCLAIMER: Because we are committed to improving our products, the details above may change without prior warning. This User Manual is published without warranty and any improvements or changes to the User Manual necessitated by typographical errors, inaccuracies of current information, or improvements to programs and/or equipment, may be made at any time and without notice. Such changes will be incorporated into new editions of the User Manual.