

Spot Instructions for Use

MODEL: VS100

SOFTWARE VERSION: 1.1.51



VISION SCREENING

P/N 20079 REV A

Table of Contents



Welcome to Spot	3
Box Contents.....	3
Product Registration.....	3
Basic Operation.....	4
Terminology.....	4
Basic Camera Care.....	5
Front Glass Care.....	5
Warnings.....	6
Screening Environment	6
Getting Started.....	7
Charging Spot	7
Powering Spot On and Off.....	7
Wrist Strap.....	7
Optional Neck Strap	8
Helpful Hints.....	8
User Operation.....	9
Main Menu.....	9
Subject Data Entry.....	10
Screening a Subject.....	12
Monocular Screening.....	13
Viewing the Results.....	14
Tools	15
Setting the Date and Time.....	16
Wireless Network Configuration.....	16
Printer Configuration	18
Import & Export	20
Viewing Criteria.....	23
Results Configuration.....	23
Security.....	24
Touchscreen Calibration	25
Web Access	26
Records.....	26
Deleting Subject Records	27
Basic Troubleshooting.....	28
Technical Description.....	29
Environmental Protection	30
EMC Information.....	30
Electromagnetic Compatibility	31
EMC Table.....	31
Specifications.....	33
Measurements.....	34
Symbols	35
Limited Warranty	37
Contacting PediaVision	38

Welcome to Spot

Welcome to the PediaVision VS100 vision screener, otherwise known as Spot. This instructions for Use document will help you learn to navigate Spot so you can make the most of your screening experiences.

Box Contents

Remove Spot and the accessories box from the packaging. In addition to the items listed (*Figure 1*), you will find a Cleaning Cloth and Velcro Cable Straps in the accessories box.

NOTE: Please do not discard the box and foam. Damages incurred by shipping Spot in non-approved packing material will void the limited warranty (see page 37 for warranty details).

If you have a Spot carrying case, place the foam from the shipping box inside the carrying case for safer transport.

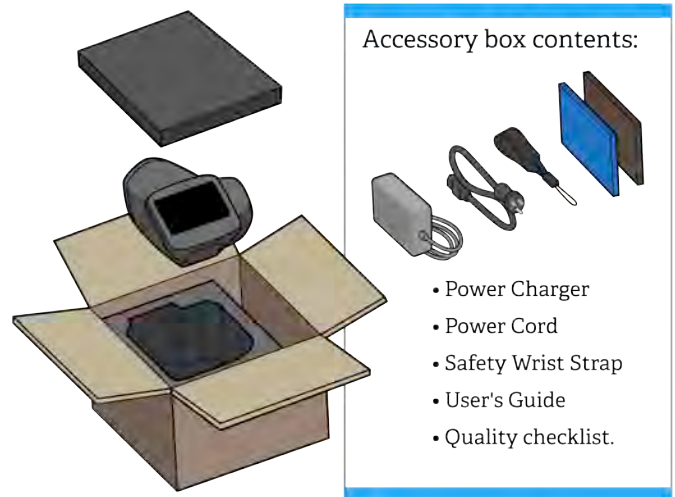

Figure 1

Product Registration

IMPORTANT: Before you begin to use Spot, it needs to be registered with PediaVision.

To register your device, please go to pediavision.com/register and provide some basic information. This will keep you in tune with the latest software updates and support services, as well as ensure warranty coverage.

Basic Operation

This section explains preparatory steps before you start screening with Spot and basic operation.

Terminology

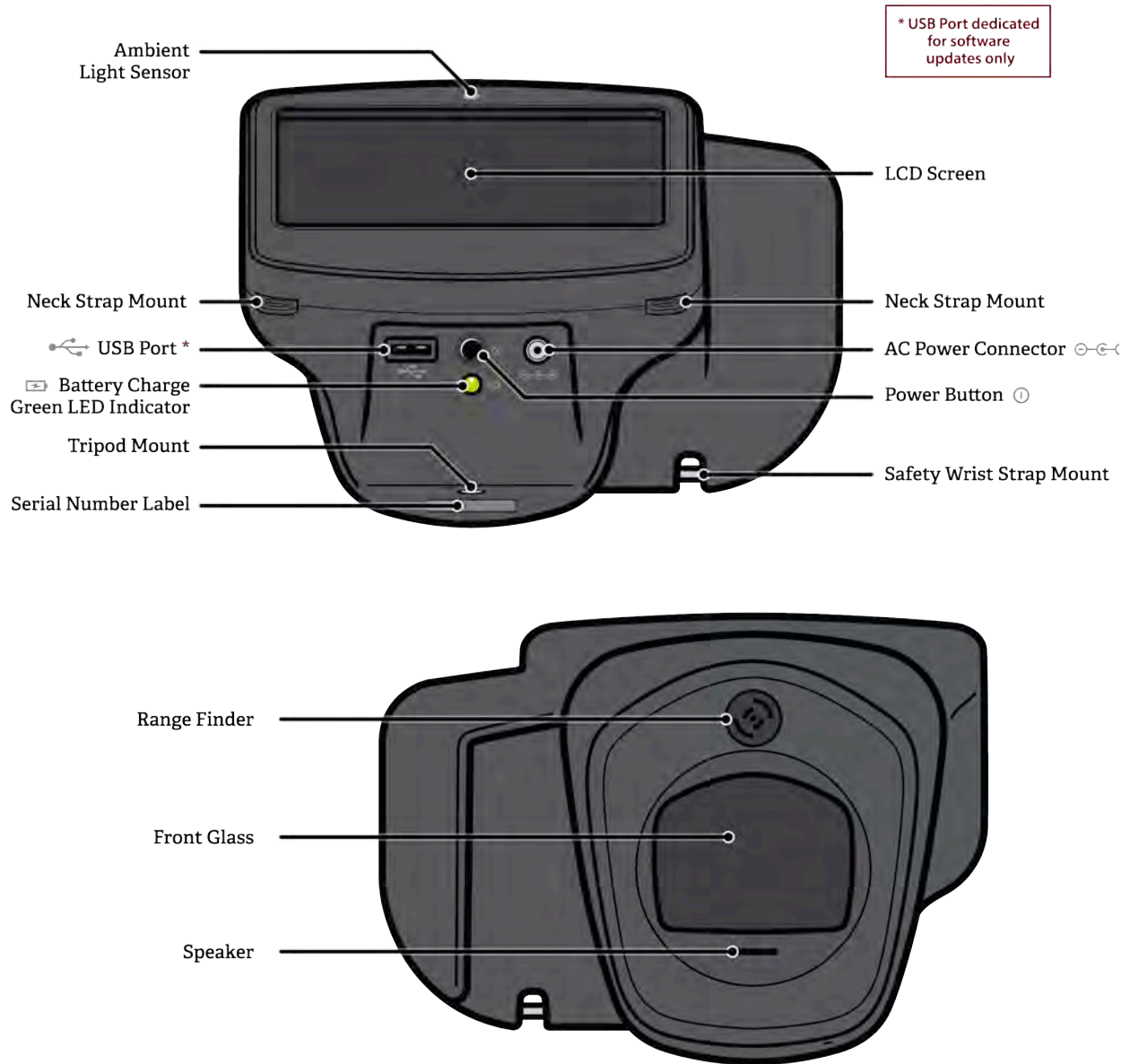

Figure 2

NOTE: The USB port shall only be used for software installations and import/export of data via a USB flash drive. It shall not be cable connected to any other device.

Basic Camera Care

1. Spot is a precision instrument. DO NOT drop it or subject it to physical shock.
2. Spot is NOT waterproof. If you accidentally drop it into liquid or liquid is spilled on it, please promptly contact PediaVision Customer Service. If minor water droplets are found on Spot, please wipe them off with a soft dry cloth.
3. DO NOT leave Spot in excessive heat such as in a car or in direct sunlight. High temperatures can cause Spot to malfunction.
4. Spot contains precision electronic circuitry. Never attempt to disassemble Spot yourself. This will void any warranty.
5. DO NOT use cleaners that contain organic solvents to clean Spot's body or front glass. For stubborn dirt, use the provided cleaning cloth with a small amount of water or a non-abrasive cleaner. If you have any questions about proper cleaning procedures, please contact PediaVision Customer Service.
6. When plugging the AC power connector into Spot, be sure NOT to force the power connector into the Spot device as this may cause damage not covered under warranty.
7. The safety wrist strap on Spot is intended to assist in the event the device slips or is dropped. It is not to be used to carry or support the weight of Spot.

Display Care

Spot has an all-in-one 5" LCD Display and touchscreen. To ensure long lasting functionality and performance, please be aware of the following:

1. DO NOT push or scratch display surface with anything stiff or rigid.
2. DO NOT spill liquids on the display. Please wipe off drops of liquid like saliva and water on LCD panel surface immediately.

Front Glass Care

Spot uses a piece of optical glass with a special coating. If dirt or fingerprints are visible, use a soft cloth to wipe clean. For stubborn dirt, try using the provided cleaning cloth with a small amount of water or a non-abrasive cleaner.

Warnings

1. Changes or modifications not expressly approved by PediaVision could void the user's authority to operate the equipment.
2. The supplied cord set is to be used. Replacement or substitution may only be done with a CSA or UL approved hospital grade power supply/charger cord set.
3. The supplied power supply/charger may not be substituted and shall only be replaced by an approved unit supplied by PediaVision.
4. Interconnection of this medical device with other medical devices, medical used systems or non-medical devices shall be evaluated to the requirements of CSA/IEC 60601-1-1 in the end use application.
5. This equipment is ESD sensitive; do not touch connector pins during use.
6. If the power cord or external power supply becomes damaged or its integrity is suspect, or the building power receptacle outlet is ungrounded, then the Spot shall only be used with the internal battery power until replacement parts become available.
7. The operator shall not touch accessible conductive parts (ac/dc adaptor output connector, camera power input connector and USB port) and the subject simultaneously.

Screening Environment

For the best screening results, be sure to screen in a proper, subdued lighting environment. **Take care to eliminate sunlight and/or incandescent light.** Florescent light is acceptable but note that the subject's pupil size will be affected by light in the room and will decrease your chances of a successful screening. Subject's pupils should be greater than 5mm for best results.

NOTE: A minimum pupil size of 4mm is required for screening to occur and may be difficult to achieve in a room with any light source. Subject's pupils should be greater than 5mm in size for best results.

Best screening environment (minimal fluorescent light):

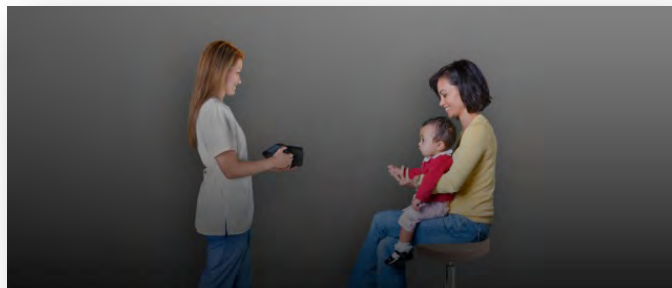



Figure 3

Getting Started

Charging Spot

Spot contains a rechargeable battery for mobile use. To charge the battery, first connect the provided AC power cord to the provided power supply/charger. Tilt Spot forward and find the power connector port , then gently insert the AC power connector as seen below. DO NOT force the AC power connector into the AC power port on Spot. It should easily insert. Forceful insertion can cause damage to Spot and potentially void the limited warranty. Finally, plug the power cable into an available AC outlet. When the battery charge indicator (green LED) is steady, no further charging is required (Figure 4). Spot will also run directly off the AC power source.

Powering Spot On and Off

To power on Spot, press and release the power button. The system will take approximately 30 seconds to complete its start-up process. When complete you will be on the Main Menu with the blue Spot logo.

To power off Spot, hold the power button for about 2 seconds. A confirmation screen will appear to confirm shutdown of the device.

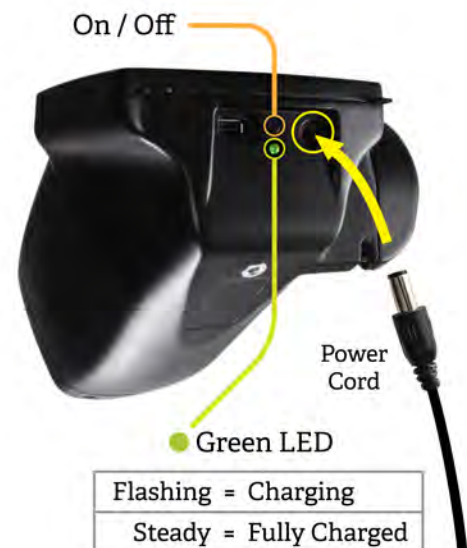

Figure 4

Wrist Strap

Use the included wrist strap as extra precaution to help prevent damage to Spot if it slips from your hands. Attach the wrist strap to the pin located under the handle.

DO NOT carry Spot by the wrist strap. The wrist strap is an extra precaution but does not guarantee damage will be prevented if dropped.

Optional Neck Strap

PediaVision offers an optional neck strap to assist during extended usage. The neck strap connects to the two tabs located below the display on Spot. Please contact PediaVision Customer Service to order a neck strap.

Helpful Hints



- When there is no activity on Spot, the device will automatically dim the screen and then turn the screen black. Simply touch the screen to bring the application back.
- To delete ALL records from Spot, go to the Records screen and touch the trash can icon. This will bring up the Delete All Records screen.
- Be sure you have correctly exported any desired data to a USB drive, then select Delete All Records.
- You can also turn the capture sound on and off by pressing the  icon in the bottom left corner of the capture screen.
- Spot has several keyboard layouts to provide all characters you may need while screening. Simply select the shift key or the special character keys to switch back and forth.
- The best way to know if your Spot is connected to a wireless network, is to go to the Main Menu and see if you see your network name and IP address are in the lower left corner.
- Spot requires a minimum pupil size of 4mm for screening to occur and this may be difficult to achieve in a room with any light source. Subject's pupils should be greater than 5mm in size for best results.
- To power off Spot, press the power button for about 2 seconds. A confirmation screen will appear to confirm shutdown of the device.
- Do not power off Spot during a screening. Instead, exit the screening by selecting the , then power down the device normally.
- Holding down the  button on any input screen will delete all data from the field.



Figure 5

User Operation

Main Menu

When Spot is powered on, the main menu screen (*Figure 5*) will appear with the following information and features. If Spot is connected to a network, the network name and IP address will be visible in the lower left corner as seen in *Figure 5* above.

Start:

To begin the screening process, select the Start function (the blue Spot logo). This will allow you to enter subject information, find queued subjects, begin the capture process, and review and print screening results.

Records:

The records section will allow you to view already screened subjects (complete records) and select individual records to review results, select queued subjects from a list to begin the screening capture process and delete all records from Spot.

Tools:

The tools section allows you to customize Spot to meet your specific needs. From Tools, you will be able to set things such as the date & time, set up a printer & print a test page, connect to a wireless network, enable a security pin, review screening criteria, set the measurement formats, recalibrate your touchscreen, import/export data and view the software version currently running on your Spot device.

Subject Data Entry

To begin screening, select the Start function (blue Spot logo) from the main menu. Using the onscreen keyboard (*Figure 6*), enter subject information as outlined below:



Figure 6





1. **Subject ID (Optional)** – If you use an ID number for the subject you are screening, enter it here. If not, you may leave this field blank and proceed to the next entry by selecting “ok” or the **continue icon** . You may also use the ID field to search for records you previously imported onto Spot. Simply type the queued subjects ID number (case sensitive) and touch the continue icon. You will skip the rest of the input screens and go straight to the Subject Confirmation screen. If you don't see the character you need, select the  icon for additional keyboards.
2. **First Name (Optional)** – The next screen will ask you for the subject's First Name. After entry, select “ok” or the **continue icon** .
3. **Last Name (Optional)** – The next screen will ask you for the subject's Last Name. After entry, select “ok” or the **continue icon** .
4. **Gender (Optional)** – The next screen will ask you to select the subject's Gender (*Figure 7*). After you make your selection, you will be moved to the DOB screen or select the **continue icon** .



Figure 7

5. **Date of Birth/Age (Required)** – On the final entry screen, you will be asked to enter the subject’s date of birth (DOB) or age in months and/or years (Figure 8). For the DOB, use the format MM/DD/YY. If entering an age, simply enter the number of months, years, or a combination of both. Example, 3 Years and 4 months would be 3y4m. After entry, select “ok” or the continue icon .



Figure 8

6. **Subject Screen** – On the subject screen (Figure 9), confirm all data is correct. To change or add information, simply select the desired field. If the DOB/age is missing or incomplete, the date of birth box will be highlighted red. Simply touch the red box to add/edit the age data. You can also select whether or not the subject has a vision prescription for glasses or contacts. After all information is confirmed, select the continue icon to begin the capture process.

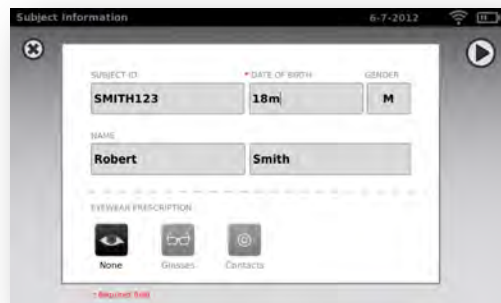

Figure 9

7. **Eyewear Confirmation Screen** – If you selected that a subject has a vision prescription on the subject screen, you will be asked if the subject is currently wearing their prescription. Simply select Yes or No. The screening will then begin.

Screening a Subject

When all information is entered position yourself about 1 meter from the subject, as shown below (Figure 10).



Figure 10

Check the lighting in your environment per the instructions on page 6 and then position yourself appropriately. Have the subject sit, cradle Spot in your left hand and hold the right handle. Prior to screening, hold the nose of Spot pointing down. Begin the screening by slowly rotating Spot upward to meet both of the subject's eyes. Adjust your distance to the subject until both eyes are clear on the screen. A blue screen indicates you are too close or too far from the subject.

NOTE: Keeping Spot even (on axis) with the subject's eyes will promote quicker results and help ensure you are not capturing other objects.



Position yourself with one foot in front of the other and slowly lean forward and back until the spinning icon appears, indicating you are in range (Figure 11). Hold the device steady until the screening process is complete.



Figure 11

You can also turn the capture sound on and off by pressing the  icon in the bottom left corner of the capture screen.

NOTE: Do not power off Spot during a screening. Instead, exit the screening by selecting the , then power down the device normally.

If you are unable to capture the subject or select the exit icon  from the screening process, you will be presented with a Screening Options menu (Figure 12). From here you can try to Re-Screen subject again, switch to Monocular screening mode, Flag the subject as unscreened, or return to the Main Menu. Selecting the exit icon  will return you to the subject information screen.

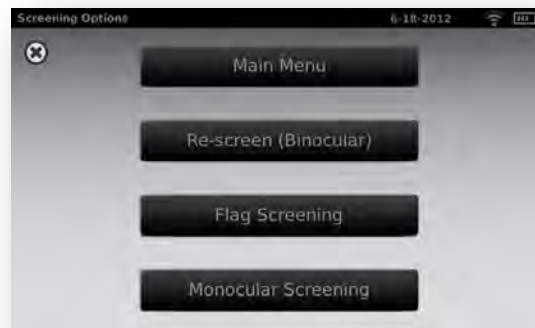

Figure 12

Monocular Screening

In monocular mode, you will be given the option (Figure 13) to choose which eye to screen. Simply touch the side of the screen that corresponds with the eye you would like to screen. When complete, you can repeat the process with the other eye by choosing Monocular from the Results Menu.





Figure 13

Viewing the Results

The results screen will appear at the end of the screening process (Figure 14).

Results that are out-of-range are indicated in red. The screener/user will make the final recommendation regarding a follow up exam with an eye care professional.

On the Results screen, you can toggle the results data between raw and formatted results by touching the values in the box under the eyes. You can also toggle between positive and negative cylinder conventions by selecting the **CYL** label found between the boxes. At any time you can select  to close this screen and return to the main menu or select the **continue icon**  for additional options.

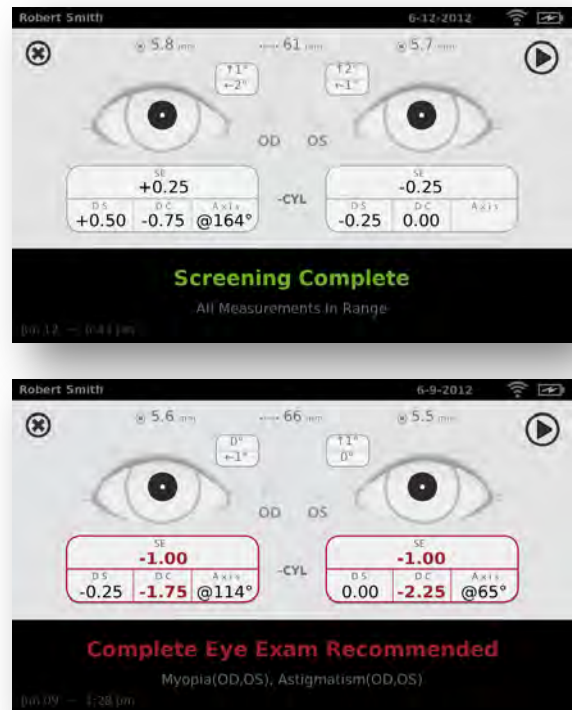

Figure 14









From the Results Menu screen (Figure 15), you can print the screening results certificate, re-screen the current subject, switch to monocular mode or return to the Main Menu.



Figure 15

Tools

The tools menu will allow you to customize and configure Spot. The main tools menu gives you the following options:

 <p>About</p>	<p>This section displays Spot's firmware version, software application version and serial number. Also displayed is a quick reference of important Spot features.</p>
 <p>Date/Time</p>	<p>This section allows you to set the current date and time for your device.</p>
 <p>Network</p>	<p>The Network section allows you to connect Spot to a wireless network. You can manually enter your network name (SSID), select the security type, and enter the passphrase for your network. From this page you can view and change your TCP/IP settings.</p>
 <p>Printer</p>	<p>This section allows you to configure a network printer and print a test page. It also lets you view printer status.</p>
 <p>Import/Export</p>	<p>This section enables you to import and export using an inserted USB storage device.</p>
 <p>Criteria</p>	<p>Here you can view the age-based criteria settings used for exam recommendations.</p>
 <p>Results</p>	<p>This section allows you to configure how data is displayed on the Results screen when a screening is complete.</p>
 <p>Security</p>	<p>This section allows you to set a security PIN for your device.</p>
 <p>Touchscreen</p>	<p>This section allows you to calibrate the touchscreen on your device.</p>

Setting the Date and Time



From the Tools menu, select the Date/Time icon. The currently set date and time will be visible as seen in (Figure 16). If it is correct, select  to return to the Tools menu.

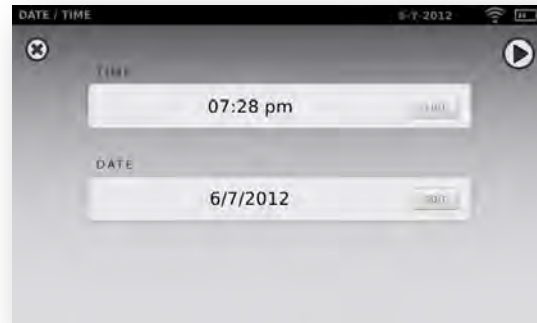



Figure 16

To change the time, touch the time field and the keypad will appear. After you enter the correct time, select the “ok” button to save your changes and return the previous screen. Alternatively, select the  button to cancel changes and return to the previous screen.

Repeat these steps to reset the date field.

Wireless Network Configuration



To connect Spot to a wireless network, you will need to access the Network section (Figure 17) of the Tools Menu. The current network settings are displayed on the screen. To add or edit any of the fields, see instructions below. If they are correct, select  to be returned to the Tools menu.



Figure 17

To add/change the network name (SSID), touch the SSID Name field and the keyboard will appear. Enter the SSID and select the “ok” button to save your changes and return the previous screen.

To add/select the security type, just touch the Security Type field. Select the appropriate security type and you will be returned to the Network screen.

To add/change the passphrase (password), touch the Passphrase button, and the edit screen will appear with a keyboard. This is only available with the security field is set to WEP or WPA.

Enter the Passphrase and select the “Ok” button to save your changes and return the previous screen.

The “Ok” button on the network screen will be darkened and available to select if any changes have been made. Select “Ok” to apply all changes made to the network settings (Figure 17).

NOTE: If you do not select “ok”, changes will not be applied.

You can enable or disable the wireless capabilities on Spot by selecting the  “On/Off” button from the network menu.

After changes have been applied, you can select  to return to the Tools menu, or select TCP/IP (Figure 18) to view advanced network settings. From here you can view your current TCP/IP address as assigned by your network, or for more advanced network configurations, you can select “Static” to manually configure your network address and settings. Also available on this screen is the MAC Address of your Spot.



Figure 18

Printer Configuration







When you select the Printer icon from the Tools menu, you will be presented with a list of available printers on your network on the Printer Tools Screen (*Figure 19*).

NOTE: Spot will search your network for available printers. For this feature to function properly, Spot will need to be connected to a wireless network before adding a printer.





Figure 19

To select or change a default printer, find the desired printer in the list, highlight it by touching it once, then touch the *Set as Default* button. To add a printer to your list, pressing the Add  button will take you to the Add Printer screen (See Adding a Printer on Page 19).

- To configure a printer, view the printer status, or print a test page, select the printer from the list then press the Edit  button. This will take you to the Printer Details Screen (See Adding, Editing or Viewing Print Configurations).
- To remove a printer, select the printer from the list and press the Delete  button. A popup will appear asking you to confirm deletion of the printer.
- To restore the printing system to factory defaults, press the trash can  button. A popup will appear asking you to confirm restoring the printing system to factory. This will remove all current printer configurations and reinstall the default Spot printer.

You can exit this screen at any time by selecting exit icon , which will return you to the Tools menu.

Adding a Printer

When you select the Add  button from the Printer Screen (*Figure 19*), you are directed to the Add Printer screen (*Figure 20*) where you can add a network ready printer. If the Printer is discovered on the network, it will show up in the list. If you wish to add this printer to Spot, select it from the list and press the **continue icon** . If the network printer you want does not show on the list, then select Add New Printer and press the continue icon . Confirm the settings and press the Save button.

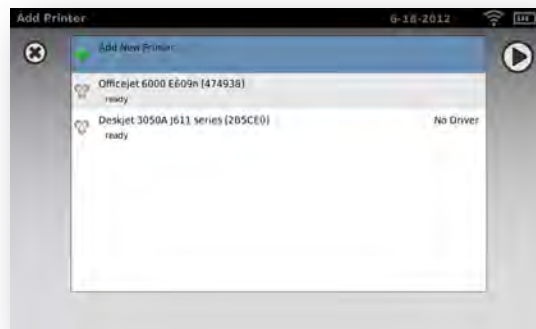

Figure 20

Adding, Editing or Viewing Print Configuration

When you select the Edit  button or you select to add a printer from the Add printer screen, you are directed to the Add Printer Details Screen (*Figure 21*). The default Spot printer information will be populated, which can be edited if needed.



Figure 21

On the Add Printer Details screen, you can change the displayed name of your printer by touching the Name field.

To select a printer driver, touch the Driver field and you will be presented with a list of available drivers. Use the search function at the top of the driver list to narrow down the number of visible drivers.

NOTE: The list of print drivers represents all printers supported by Spot.

The Location is the network location of the printer, and is automatically given a local name by Spot. To select a custom TCP/IP address location of the printer, touch the Location field and enter a new location as "socket://xxx.xxx.xxx.xxx" where xxx.xxx.xxx.xxx is the TCP/IP address of the printer.

When all printer settings are complete and valid, the Save button will be dark grey. Touch the Save button to save all settings, or at any time press the exit icon  to return to the previous screen without making changes.

NOTE: It may take several minutes after hitting save for the changes to take affect.

When your printer settings have been saved, the Print Test Page will be dark grey. Press the Print Test Page button to test the printer configuration. A print icon will appear in the menu bar indicating the job is processing. Also, the number of jobs in the print queue will show up in the Jobs box at the top of the screen, along with the current printer status as shown in (Figure 22).



Figure 22

NOTE: If you are having a problem with your printer or a job is stuck in the queue, select the reset button to clear the print job and reset the printer.

Import & Export



Importing and Exporting files to and from Spot is quick and easy. Simply insert a USB storage device into the USB port on Spot (refer to Page 4 - Terminology for USB port location). From the Tools menu, select Import/Export and you will be directed to the Import/Export screen (Figure 23). When a USB device has been detected, the Import and Export buttons will be available to select. The Import button will only become available if Spot recognizes a valid import file on the USB drive.



Figure 23

NOTE: If the buttons do not highlight within 5 seconds of inserting the USB drive, remove the USB, insert it into your PC and delete all files from the drive. If you are importing a file, be sure to put the import file back on the USB drive before continuing.

Export - To export data from Spot, select the Export button. You will be asked whether or not to exclude personal data. **The Exclude Personal Data function will export a single Comma Separated Values (.csv) file with all screening data, except the subject's first name, last name, and DOB.** To exclude personal information, press the Exclude Personal Data label on the screen and an [X] will appear next to the label.

Select the Export button, and do not remove the USB drive until the export is complete. Spot will indicate "Export Successful" when the export completes and it is then safe to remove the USB drive. If the USB is withdrawn prior to the export being complete, incomplete or corrupted data may be the result. This may cause problems with both Spot and your USB drive.

If you do not select the exclude personal data option, Spot will export the following information:

- 1) PDF's of all completed subject screenings (located in the "current" folder).
- 2) Spot Results file (located in the "current" folder).
- 2) Spot Criteria file (located in the "config" folder).
- 3) Spot Subjects Template file (located in the "config" folder).
- 4) Spot's Complete database file (located in the "db" folder).

NOTE: When data is exported to Spot, a new folder will be created on the USB drive. The folder will be in the format of 'Spot_SerialNumber_YYYYMMDD_HHMMSS'. All export data will be put into this folder.

Import - All files must be located in the root or top directory of the USB drive (not in a folder) and must have the correct naming convention for Spot to recognize it for import. With Spot's import function, you can import an updated Criteria file, an upcoming subjects file, or a custom banner for the screening reports.

Spot Criteria

The easiest way to modify the current criteria being used on the Spot is to first export the current criteria file. This gives you a copy of the current criteria file located in the "config" folder. After the export is complete, insert the USB in your PC and go to the USB drive folder on your PC. Select the Spot folder that you just exported, then select the "config" folder. Here you will find a file called "SpotCriteria.csv". Make a copy of the criteria file and paste it into the main directory of the USB drive (root or top directory level). Make any desired changes (using Microsoft Excel, or similar) then save the file as a Comma Separated Values (csv) file. Ensure the file is still called "SpotCriteria.csv". Remove the USB drive from your PC and insert it into Spot. Go to the "Tools" menu, then "Import / Export". Select the "Import" option to import the updated criteria file. To check to see if the file was imported successfully, go to the Tools menu then to Criteria and review the new criteria settings.

Spot Subjects

Spot gives you the ability to be ahead of the game with the Subject import function. The easiest way to import subjects is to first export the subject from Spot. This gives you a template to use for the import file. After the export is complete, insert the USB into your PC and go to the USB drive on your PC. Select the Spot folder that you just exported, then select the "config" folder. Here you will find a file called "SpotSubjects.csv". The file will contain 6 columns. It is imperative that you do not change any of the column headings. Only add information to the columns, as shown below:

1. **Subject ID** – You can use any combination of alpha, numeric characters and symbols. This field is also used for the subject lookup feature. To quickly look-up queued subjects the best combination is Alphanumeric characters only.
2. **First Name** – Enter the first name. Use any combination of alpha characters.
3. **Last Name** – Enter the last name. Use any combination of alpha characters.
4. **Date of Birth** – Enter the data of birth in the format MM/DD/YY or YYYY. You may also enter the age of the subject in years, months or a combination of both. Example: a subject that is 2 years and 10 months old would be entered 2Y10M. Use numeric and alpha characters.
5. **Gender** – Enter Male or M, or Female or F. Alpha characters only. Leaving the field blank will default to Male when importing.
6. **Eyewear** – Enter None, Glasses, or Contacts. Leaving the field blank will result in 'None' as the default when importing.

After updating the import file, ensure you save it as a Comma Separated Values (.csv) file, and that the file name is SpotSubjects.csv. Follow the import procedures to load the file onto Spot. To verify that the file was imported successfully, go to the Records menu and select "Queue" to view the new records.

Custom Banner

PediaVision offers the ability to add a custom banner to the bottom of the printable reports. Banner files must be named "banner.png" and be no larger than 1MB. The banner image must be 1376 x 240 pixels or it will not fit on the printout. Place the banner.png file on the root/top directory level of the USB then place the USB in the Spot. The import file option will highlight, select Import. To verify that the file was imported successfully, either screen a new subject or select a completed record and print the certificate. Ensure the new banner has been properly inserted on the bottom of the printable report.

Viewing Criteria



To view the current age based criteria on your device, select Criteria from the tools menu. A table will be displayed that shows the current criteria used to compute the screening results. To change the criteria, please see the Import / Export section for details on how to update the Spot Criteria file.

Results Configuration



To change how results are displayed on the Results Window after a screening, select the Results option from the Tools Menu. You will be presented with a Results Options screen from which you can customize your Results (Figure 24). When a selection is made, the changes will take effect immediately for the next screening.

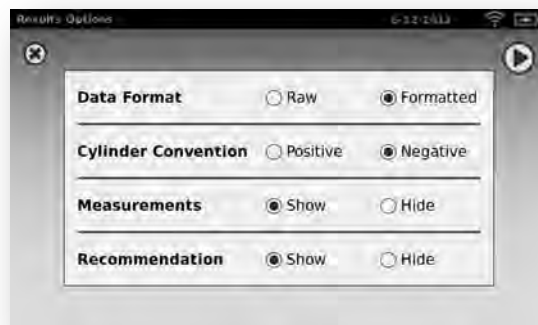

Figure 24

Data Format – The changes to this configuration will show either formatted or raw refractive values on the Subject Results screen. If Formatted version is chosen, Spot will round the refractive results to the nearest quarter diopter. You can toggle between the formatted and raw versions on the results screen by touching the data boxes of either eye. The settings here indicate which version is shown by default on the Subject Results screen.

Cylinder Convention – The changes to this configuration will show either positive or negative cylinder convention on the Subject Results screen. You can toggle the between positive and negative on the results screen by tapping on the **CYL** icon between the data fields. Please note that the Axis will shift by 90°. The settings here indicate which version is shown by default on the Subject Results screen.

Measurements – After a screening is complete, Spot will present eye measurements on the screen and on the printed certificate. Selecting “Hide” will prevent Spot from showing these measurements on the screen. The data will be saved to the database on Spot and can be recalled later.

NOTE: If you select “Hide” Measurements, the device will automatically hide the recommendation as well.

Recommendation – Spot will inform you if a subject is “in” or “out” of range and if a full comprehensive eye exam should be recommended. Selecting Hide will prevent Spot from making a recommendation on the Results Screen or Printed Reports.

Security

Spot gives you the ability to add a layer of security to your device through the use of a PIN code. To enable the use of the PIN code, select Security from the tools menu. You will be asked if you would like to use a security pin code. If you select this option Spot will ask you to enter a 4-digit pin code and then re-enter the same pin to confirm. Security will then be enabled. To disable, simply uncheck “Use Security Pin Code” and you will be asked to confirm by entering your PIN.

To lock the screen, simply press and hold the power button for 2 seconds, until the power off popup appears. Spot will ask you if you would like to Power Off, Lock, or Cancel. Select Lock and your Spot will be locked. If you let Spot sit idle for more then five minutes, or power off Spot with Security enabled, you will be prompted to enter your pin before you can use Spot (Figure 25).



Figure 25

Touchscreen Calibration



The Spot touchscreen can be calibrated by selecting Touchscreen from the tools menu. You will be asked to confirm whether or not you want to calibrate the screen. If you select Calibrate, it is a simple two-step process to complete calibration:

Step 1 – A series of 5 crosshairs will appear one after the other, starting in the upper left hand corner (Figure 26). Simply touch each target as close to center as possible (a stylus is a useful tool for calibrating the touchscreen). After all 5 targets have been touched, move to Step 2.

NOTE: If you do not touch the first target within 15 seconds, the calibration will be cancelled.

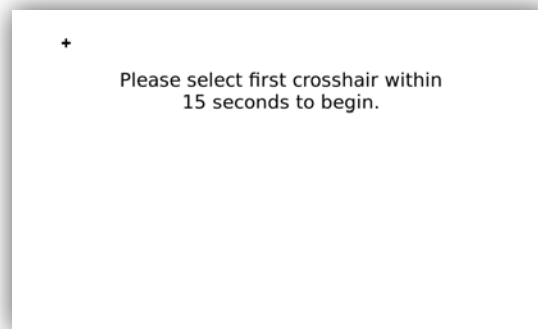

Figure 26

Step 2 – A series of 5 confirmation targets will appear one after the other, starting in the upper left hand corner again (Figure 27). Simply touch the crosshairs without going outside the circle surrounding each target, and the calibration will be complete.

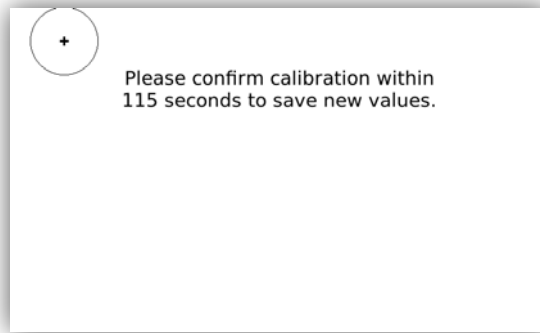

Figure 27

NOTE: If you touch outside the confirmation circle for the targets, the calibration will be cancelled and the previous settings will be used.

Web Access



When connected to a wireless network, Spot gives you the ability to view the PDF reports and the SpotResults.csv file from a Web Browser (Internet Explorer, Firefox, Safari, etc.) on another PC on the same network. To access the webserver on Spot, simply open your web browser and enter Spot's IP address in the address bar. The Username is *spot* and the default password is *0000*. If you have enabled security on your device, the password will be your PIN code.

Records

On the Records page (Figure 28) you can view previously screened subjects (Complete tab), as well as any queued subject data (Queue tab) that was previously imported or subjects of incomplete screenings that still require screening. The maximum storage capacity of Spot is 3000 completed screenings.



Figure 28

-  Red square indicates a subject that has been screened and at least one result was out-of-range based on criteria at time of screening.
-  Green indicates the subject has been screened and all readings were within the range based on the criteria at time of screening.
-  Subjects with no color indicate the subject has not yet been screened.

If you select a previously screened/complete subject, the final results page will be displayed. If you selected a queued subject, you will be directed to the Subject Information screen to verify the data and start a new screening.

Deleting Subject Records

To delete all records on Spot, select the trash can icon  located on the bottom left corner of the Records screen (*Figure 28*). All subject data will be deleted permanently so ensure you have exported any data you wish to save with the Import/Export function located in the Tools menu. Once you select the trash can icon, the "Delete All Records?" screen will appear. To remove all subject records, select "Delete All Records", otherwise select "Cancel" to return to the Records menu and no data will be removed.

NOTE: Regularly deleting the records will ensure you always have enough storage space on Spot.

Basic Troubleshooting

System Restart

To power cycle Spot, simply press and release the power button. After confirming shutdown, Spot will turn itself off. After the screen is black, wait 30 seconds and then press the power button to turn Spot back on.

System Freeze

In the event the Spot locks up and is unresponsive to touch, you will need to perform a hard system reset. To reset Spot, press the power button. If the Power Off window appears, select the *Power Off* button to shutdown the device. If not, **press and hold** the power button until the screen goes black. Release the power button. Wait about 1 minute, then perform the normal start-up process.

NOTE: This may cause some data loss (ex. printer configuration and subject data).

Printer Issues

First always check that your printer is turned on and has sufficient ink. You can usually do this by printing a test print page directly from the printer. After you confirm your printer is in proper working order ensure the printer is on a local network by printing to the printer from a PC on the same local network. If all of the above are in working order then try restarting Spot as stated under "System Restart". If issues continue, please contact PediaVision Customer Service for further assistance.

For more information on troubleshooting or error messages, visit pediavision.com (refer to the last page of this manual for additional contact information).

Wireless Issues

If you encounter problems connecting to a wireless network, first ensure all network settings are entered correctly. If the settings are correct, try turning Spot off then back on. Often it will help initiate the connection to the network with a restart.

For more information on troubleshooting or error messages, visit pediavision.com (refer to the last page of this manual for additional contact information).

Technical Description

General

Spot model VS100 will be referred to as Spot below.

The external power supply/charger supplied is a Class I equipment and the Spot is also a Class I equipment when connected to the external power supply/charger.

Spot is internally powered by equipment (battery) when not connected to the external power supply/charger.

Protection against electric shock, no applied part.

Spot is rated IPX0 and thus not protected from the ingress of water.

Spot does not require sterilization or disinfection. DO NOT use cleaners that contain organic solvents to clean Spot's housing or front glass. For stubborn dirt, try using a soft cloth with a small amount of water or a non-abrasive cleaner.

Spot is not suitable for use in the presence of a flammable anesthetic mixture with air or with oxygen or nitrous oxide.

Spot is suitable for continuous operation.

Spot is a breakthrough device that quickly and easily detects vision issues across all age groups starting at 6 months.

Spot helps ensure children have an opportunity to reach their full potential. Designed to work as easily with toddlers as with teenagers; Spot provides reliable data in seconds. With Spot, educators, healthcare professionals, and charitable organizations can now confidently assess eyesight for all ages. Spot is powered by sophisticated technology that quickly detects the indication of the following vision issues:

- Near-sightedness (myopia)

- Far-sightedness (hyperopia)

- Unequal refractive power (anisometropia)

- Blurred vision, eye structure problem (astigmatism)

- Pupil size deviations (anisocoria)

- Eye misalignment (strabismus)

In just seconds, Spot provides a comprehensive, reliable analysis that enables informed decision making about the need for care with a vision specialist.

Pediavision suggests a battery replacement, at an appointed Pediavision repair facility, every 2.5 years at the owner's expense. Spot regular maintenance consists of wiping dust or dirt off the surface as needed.

The USB port shall only be used for software download/upload via a USB key and shall not be cable connected to any other device.

The power supply/charger supplied with Spot has the following characteristics:

International Power Corporation, Elpac Power Systems,

Model MW4015-760F-NC-BK

Input Voltage 85 – 264VAC (100 – 240VAC Nominal)

Input Frequency 47 – 63 Hz

Input Current < 1A rms

Efficiency Avg. Efficiency 86.4% @ 115VAC; 85.7% @ 230VAC

Environmental Protection

This device contains Lithium ion cells. Please contact PediaVision for proper disposal instructions at end of life.

EMC Information

This device complies with Part 15 of the FCC Rules. Operation is subject to the following two conditions: (1) this device may not cause harmful interference and (2) this device must accept any interference received, including interference that may cause undesired operation.

NOTE: Changes or modifications not expressly approved by the party responsible for compliance could void the user's authority to operate the equipment. This equipment has been tested and found to comply with the limits for a Class A digital devices, pursuant to Part 15 of the FCC Rules. This medical device equipment is suitable for use in all establishments other than domestic and those directly connected to the public low-voltage power supply network that supplies buildings used for domestic purposes. This equipment generates, uses, and can radiate radio frequency energy and, if not installed and used in accordance with the instruction manual, may cause harmful interference to radio communications. However, there is no guarantee that interference will not occur in a particular installation. If this equipment does cause harmful interference to radio or television reception, which can be determined by turning the equipment off and on, the user is encouraged to try to correct the interference by one or more of the following measures:

Reorient or relocate the receiving antenna

Increase the separation between the equipment and receiver

Connect the equipment into an outlet on a circuit different from that to which the receiver is connected.

Consult the dealer or an experienced radio/TV technician for help.

Electromagnetic Compatibility

This product conforms to the EMC standard (IEC 60601-1-2:2007).

MEDICAL ELECTRICAL EQUIPMENT needs special precautions regarding EMC and needs to be installed and put into service according to the EMC information provided in the accompanying documents.

Connectors should not be touched and connections should not be made to these connectors unless ESD precautionary procedures are used. Provided ESD connector covers shall be installed when the connector is not in use.



ESD protection mark may be used in lieu of protective covers.

Portable and mobile RF communications equipment can effect medical electrical equipment.

The use of accessories and cables other than those supplied with the instrument exception for cables sold by the manufacturer of the equipment as replacement parts, may result in increase emission or decrease immunity of the equipment or system.

The equipment or system should not be used adjacent to or stacked with other equipment. If adjacent or stacked use is necessary, the equipment or system should be observed to verify normal operation in the configuration in which it will be used.

EMC Table

Emission Guidance		
The Pediavision Spot is intended for use in the electromagnetic environment specified below. The operator or the user of Spot should assure that it is used in such an environment.		
<i>Emission Test</i>	<i>Compliance</i>	<i>Electromagnetic environment guide</i>
RF Emission Cispr 11	Group 1	Spot must emit electromagnetic energy in order to perform its intended function. Nearby electronic equipment may be affected.
RF Emission Cispr 11	Class A	Spot is suitable for use in all establishments other than domestic and those directly connected to the public low-voltage power supplies building used for domestic purposes.
Harmonic Emission IEC 61000-3-2	Class A Compliant	
Voltage Fluctuation/flicker Emission IEC 61000-3-3	Compliant	

Immunity Guidance

Spot is manufactured to work in the electromagnetic environment specified below. The operator or user should make sure it is used within those environmental conditions.

<i>Immunity Test</i>	<i>Test level EN 60601-1-2</i>	<i>Conformity Level</i>	<i>Electromagnetic environment guide</i>
Electrostatic Discharge (ESD) EN 61000-4-2	± 8kV air ± 6kV contact	Non-conforming This unit is sensitive to ESD and may require resetting	The floor should be in wood, concrete or ceramic tile. If the floor is covered with synthetic material, relative humidity should be at least 30%.
Electrical Fast Transient/Burst EN 601000-4-4	±2 kV high voltage power line	±2 kV high voltage power line	The quality of the power supply should be that one of a typical commercial or clinical environment.
Surge EN 61000-4-5	Differential mode: ±1 kV Common mode: ±2kV	Differential mode: ±1 kV Common mode: ±2kV	The quality of the power supply should be that one of a typical commercial or clinical environment.
Voltage dips, short interruptions and voltage variations on power supply input lines EN 61000-4-11	<5% UT (>95% dip of UT) for 0,5 cycle 40% UT (>60% dip of UT) for 5 cycle 70% UT (>30% dip of UT) for 25 cycle <5% UT (>95% dip of UT) for 5 seconds	<5% UT (>95% dip of UT) for 0,5 cycle 40% UT (>60% dip of UT) for 5 cycle 70% UT (>30% dip of UT) for 25 cycle <5% UT (>95% dip of UT) for 5 seconds	The quality of the power supply should be that one of a typical commercial or clinical environment. If the user requests a continuous functioning during power supply interruptions, it is recommended a backup power supply unit (UPS) or battery.
Magnetic field at power frequency EN 61000-4-8	3 A /m	3 A /m	Power frequency magnetic fields should have characteristic levels of a typical commercial or clinical environment.

Immunity Radio Frequency Guidance

Spot is manufactured to work in the electromagnetic environment specified below. The operator or user should make sure it is used within those environmental conditions.

<i>Immunity Test</i>	<i>Test level EN 60601-1-2</i>	<i>Conformity Level</i>	<i>Electromagnetic environment guide</i>
Conducted RF EN 61000-4-6	3 Veff from 150kHz to 80MHz	3 Veff from 150kHz to 80MHz	The portable and mobile devices with RF communication shouldn't be used near any part of the device, including cables, except when they follow the recommended safety distance for separation, calculated with the equation applicable to the frequency of the transmitter. Recommended safety distance for separation: $D = 1,2 \times \sqrt{P}$ from 150kHz to 80MHz $D = 1,2 \times \sqrt{P}$ from 80MHz to 800MHz $D = 2,3 \times \sqrt{P}$ from 800MHz to 2,5GHz Where P is the nominal maximum power of the transmitter output expressed in Watts (W) as specified by the transmitter manufacturer and d is the recommended separation distance expressed in meters (m).
Radiated RF EN 61000-4-3	3 V/m from 80MHz to 2.5GHz	3 V/m from 80MHz to 2.5GHz	
Surge EN 61000-4-5	Differential mode: ±1 kV Common mode: ±2kV	Differential mode: ±1 kV Common mode: ±2kV	

The field intensity of the fixed RF transmitters, as checked in an electromagnetic investigation of the locus, should be less than the conformity level for each range of frequency.

It is possible to have interference near devices marked with the symbol:



Recommended separation distance between portable or mobile devices for radio communication and the device

Spot is manufactured to work in an electromagnetic environment in which the radiated RF disturbances are controlled. The operator or user of the device could prevent electromagnetic interferences by assuring a minimal distance between the portable or mobile RF communication devices (transmitter) and the device as recommended in the chart below, in respect of the output maximum power of the radio-communication devices.

Output maximum frequency (m) nominal power of the transmitter (W)	Separation distance at the transmitter Output maximum frequency (m)		
	from 150kHz to 80MHz $D= 1,2 \times \hat{O}P$	from 80MHz to 800MHz $D= 1,2 \times \hat{O}P$	from 800MHz to 2,5GHz $D= 2,3 \times \hat{O}P$
0.01	0.12	0.12	0.23
0.1	0.38	0.38	0.73
1	1.2	1.2	2.3
10	3.8	3.8	7.3
100	12	12	23

For the transmitter with output maximum nominal power not reported above, the separation distance d in meters can be calculated using the applicable equation at the frequency of the transmitter, where P is the output maximum nominal power of the transmitter in Watts specified by the transmitter manufacturer.

- Notes:
- (1) At 80 MHz and 800 MHz it is applicable the higher frequency range.
 - (2) This line guide could not be applicable in every circumstance. The electromagnetic propagation is affected by the absorption and the reflection of structures, people or objects.

Specifications

Dimensions (in): 8½ x 6¾ x 4¾ (LxWxH)

Weight (lbs): ~2.55

Operating Temperatures (°C): +10 to +40

Operating Humidity: 30% to 75% Relative Humidity (non-condensing)

Storage/Shipping Temperatures (°C): 0 to 50

Storage/Shipping Humidity: 0% to 75% Relative Humidity (non-condensing)

Storage/Shipping Atmospheric Pressure: 800 hPA to 1060 hPA

Expected Battery Life: 2.5 Years (Under Normal Usage)

Measurements

Refraction

Spherical Equivalent:

- Range: -7.50D to +7.50D in 0.25D increments
- Accuracy: -3.50D to 3.50D, $\pm 0.50D$
-7.50D to $< -3.50D$, $\pm 1.00D$
> 3.50D to 6.00D, $\pm 1.00D$

Cylindrical:

- Range: 0.00D to +3.00D in 0.25D increments
- Accuracy: 0.00D to 1.50D, $\pm 0.50D$
> 1.50D to 3.00D, $\pm 1.00D$

Cylindrical Axis:

- Range: 1 to 180 degrees in 1 degree increments
- Accuracy: ± 5 degrees (for cylinder values $> 0.5D$)

Pupil size:

- Range: 4.0 mm to 9.0 mm in 0.1 mm increments
- Accuracy: $\pm 0.1mm$

Pupil distance:

- Range: 35mm to 80 mm in 1 mm increments
- Accuracy: ± 1 mm









Time per measurement: 1 s













Measuring distance: 1 m \pm 5 cm

Fixation target: Random visual pattern and audible sound.

Measurement principal: Optical reflex.

Symbols

	DC Power
IPX0	Ingress protection
	Battery inside (not user replaceable)
	Battery charging (flashing) charged (continuous)
	Power On/Off
	Non-ionizing electromagnetic radiation
	Refer to instruction manual
	<p>This symbol is applicable for EC member countries only. To avoid potential negative consequences for the environment and possibly human health, this instrument should be disposed of (i) for EU member countries - in accordance with WEEE (Directive on Waste Electrical and Electronic Equipment) or (ii) for all other countries, in accordance with local disposal and recycling laws.</p>
	ESD Protection Mark
	USB (software updates only)

	DC power input port, center pin positive
	Battery Status/Level Indicator (Graphics Display Icon)
	Connected to the wireless network (Graphics Display Icon)
	No wireless network in range (Graphics Display Icon)
	No IP address assigned by the router (Graphics Display Icon)
	Unknown network (Graphics Display Icon)
	Cannot connect to configured network (Graphics Display Icon)
	Sound Off (Graphics Display Icon)
	Sound On (Graphics Display Icon)
	Continue Icon
	Back Icon
	Exit to Previous Screen or Main Menu



Print Job in Progress

Limited Warranty

PediaVision provides the following limited warranty for Equipment:

PediaVision provides a limited repair or replacement warranty and agrees and warrants only that Equipment (Equipment means the medical device outlined in this document, model number VS100 "Spot") will be fit for its intended purpose and without material defect in workmanship and materials for the one (1) year period following delivery date. Equipment shall not be considered defective if it is a different color than shown in PediaVision's materials and no warranty is made relating to color. All requests for warranty work are subject to Equipment inspection at PediaVision contracted facilities. End User must ship the Equipment for inspection to PediaVision's dedicated warranty and repair facility at User's expense. Misuse, improper usage and/or handling, dropping, improper repairs, improper maintenance and care, or accidental, abusive, or negligent treatment of the Equipment will invalidate PediaVision's warranty. PediaVision shall not be responsible after delivery of the Equipment to End User for maintenance or support of the Equipment, only for warranty services. This warranty is not a guarantee that the Equipment will not through use or handling develop wear, tear, and mechanical breakdown from time to time, the repair of which is the sole responsibility of the End User if beyond the stated warranty period or excluded from warranty coverage for the reasons stated hereinabove. If a returned item of Equipment is evaluated and found defective and the warranty for such Equipment is in force, PediaVision will bear the cost of shipping the repaired or replacement Equipment to End User; otherwise, all shipping costs will be borne solely by the End User. No statement, remark, or representation of any employee or representative of PediaVision may vary this limited warranty unless in writing and signed by an officer of PediaVision. This warranty shall be void if User loads or uses any software programs or applications on Equipment other than the software installed and licensed to User by PediaVision. This warranty shall be void if PediaVision finds that Equipment has been opened or the hardware has been altered in any way. All warranty claims must be made in writing addressed to PediaVision within the warranty period.

PediaVision does not warrant accessories.

Contacting PediaVision

If you have questions about Spot, PediaVision Support is available Monday – Friday, 9:00 am – 5:30 pm ET, excluding holidays. Visit us online anytime at pediavision.com, email your questions or call during normal business hours:

Email:

Customer Service	support@pediavision.com
Sales	sales@pediavision.com
General Information	info@pediavision.com

Phone:

Customer Service	888.514.7338 x 102
Operator	888.514.7338 x 100

Address:

PediaVision Holdings, LLC
200 Waymont Court, Suite 122
Lake Mary, FL 32746
USA



VISION SCREENING