

Getac

B300
USER MANUAL

Rugged Mobile Computing Solution

August 2014

TRADEMARKS

The Bluetooth® word mark and logos are registered trademarks owned by Bluetooth SIG, Inc.

All brand and product names are trademarks or registered trademarks of their respective companies.

NOTE

The information in this manual is subject to change without notice.

For the latest version of the manual, please visit the Getac website at www.getac.com.

Table of Contents

Chapter 1	Getting Started.....	1
	Getting the Computer Running.....	2
	Unpacking.....	2
	Using the Tether (Optional).....	3
	Connecting to AC Power.....	4
	Turning On and Off the Computer.....	5
	Taking a Look at the Computer.....	7
	Front Components.....	7
	Rear Components.....	8
	Right-Side Components.....	9
	Left-Side Components.....	10
	Top-open Components.....	12
	Bottom Components.....	15
Chapter 2	Operating Your Computer.....	16
	Using the Keyboard.....	17
	Typewriter Keys.....	17
	Cursor-Control Keys.....	17
	Numeric Keypad.....	18
	Function Keys.....	19
	Fn Key.....	19
	Hot Keys.....	19
	Windows Keys.....	21
	Using the Touchpad.....	22
	Configuring the Touchpad.....	24
	Using the Touchscreen (Optional).....	25
	Using the Quick Buttons.....	27
	Using the DVD Drive.....	29
	Inserting and Removing a Disc.....	30
	Using the Network Features.....	32
	Using the LAN.....	32

	Using the WLAN.....	32
	Using the Bluetooth Feature.....	34
	Turning On/Off the Bluetooth Radio	34
	Connecting to another Bluetooth Device.....	35
	Using the WWAN Feature (Optional).....	36
	Installing a SIM Card.....	37
	Turning On/Off the WWAN Radio.....	38
	Setting up a WWAN Connection	39
	Using the Fingerprint Scanner	41
Chapter 3	Managing Power	43
	AC Adapter	44
	Battery Pack.....	45
	Charging the Battery Pack	45
	Initializing the Battery Pack.....	46
	Checking the Battery Level	46
	Battery Low Signals and Actions	47
	Replacing the Battery Pack	48
	Power-Saving Tips	49
Chapter 4	Expanding Your Computer	50
	Connecting a VGA or HDMI Display Monitor	51
	Connecting a Serial Device	53
	Connecting a USB Device.....	54
	Connecting an eSATA Device	55
	Connecting an IEEE 1394 Device.....	56
	Connecting Audio Devices.....	57
	Using Smart Cards	58
	Using PC Cards.....	59
	Using ExpressCards.....	60
	Using Storage Cards.....	61
	System Memory Upgrade	62
	Replacing the Hard Disk Drive	64
	Installing a Secondary Battery Pack or Hard Disk Drive	65
Chapter 5	Using BIOS Setup	66
	When and How to Use.....	67
	Menu Descriptions	68
	Information Menu	68
	Main Menu.....	68
	Advanced Menu.....	69

	Security Menu	71
	Boot Menu	72
	Exit Menu	72
	Quick BIOS Settings.....	73
Chapter 6	Using Getac Software	74
	G-Manager	75
	System Tab	76
	Battery Tab.....	77
	ECO Tab.....	79
	Light Sensor Tab	81
	Antenna Tab	82
	Monitoring Tab.....	83
	GPS Status Tab	85
	P1 Quick Button Definition Utility.....	86
Chapter 7	Caring for the Computer	88
	Protecting the Computer.....	89
	Using an Anti-Virus Strategy.....	89
	Using the Cable Lock.....	89
	Taking Care of the Computer	90
	Location Guidelines	90
	General Guidelines	91
	Cleaning Guidelines.....	91
	Battery Pack Guidelines.....	92
	Touchscreen Guidelines.....	93
	When Traveling.....	94
Chapter 8	Troubleshooting	95
	Preliminary Checklist.....	96
	Solving Common Problems.....	97
	Battery Problems	97
	Bluetooth Problems.....	97
	Display Problems.....	98
	DVD Drive Problems	98
	Hardware Device Problems.....	99
	Hard Disk Drive Problems.....	99
	Keyboard and Touchpad Problems	100
	LAN Problems.....	100
	Power Management Problems	101
	Software Problems	101

Sound Problems	101
Startup Problems	102
WLAN Problems	102
Other Problems	104
Resetting the Computer	105
System Recovery	106
System Restore, Refresh, or Reset (for Windows 8 Models).....	106
System Recovery (a Tool for Windows 7 Models).....	107

Appendix A Specifications 109

Appendix B Regulatory Information..... 111

On the Use of the System	112
Class B Regulations	112
ANSI Warning.....	113
Safety Notices.....	114
On the Use of the RF Device.....	116
USA and Canada Safety Requirements and Notices.....	116
European Union CE Marking and Compliance Notices...	118
User Notification of Take-back Service.....	120
ENERGY STAR	121
Battery Recycling.....	123

Chapter 1

Getting Started

Congratulations on purchasing this rugged computer.

This chapter first tells you step by step how to get the computer up and running. Then, you will find a section briefly introducing the external components of the computer.

Getting the Computer Running

Unpacking

After unpacking the shipping carton, you should find these standard items:

- Rugged computer
- Accessories:
 - AC adapter
 - AC power cord
 - Document(s)
 - Driver disc
 - Stylus and tether (depending on your model)

Inspect all the items. If any item is damaged or missing, notify your dealer immediately.

Using the Tether (Optional)

A tether is provided for attaching the stylus to your computer.

1. Insert one of the tether's loop ends through the hole of the stylus (as indicated by **1** below). Then, insert the other end through the first loop (as indicated by **2** below) and pull it tight.



2. Insert the other loop end to the hook on the computer (as indicated by **1** below). Then, insert the stylus end through the loop (as indicated by **2** below) and pull it tight.



Connecting to AC Power

It is suggested that you use AC power when starting up the computer for the very first time.

1. Plug the DC cord of the AC adapter to the power connector of the computer (❶).
2. Plug the female end of the AC power cord to the AC adapter and the male end to an electrical outlet (❷).



3. Power is being supplied from the electrical outlet to the AC adapter and onto your computer. Now, you are ready to turn on the computer.

CAUTION: Use only the AC adapter included with your computer. Using other AC adapters may damage the computer.

NOTE: When the AC adapter is connected, it also charges the battery pack. For information on using battery power, see Chapter 3.

Turning On and Off the Computer

Turning On

1. Open the top cover by pushing on the cover latch (❶) and lifting up the cover (❷). You can tilt the cover forward or backward for optimal viewing clarity.



2. Press the power button (⏻). The Windows operating system should start.



Turning Off

When you finish a working session, you can stop the system by turning off the power or leaving it in Sleep or Hibernation mode:

To...	Do this...	
	Windows 8	Windows 7
Power off (Shutdown)	<ol style="list-style-type: none">1. Open the Charms Bar of Windows by moving the mouse cursor to the upper-right or lower-right corner of the screen.2. Click Settings and then click  (Power).3. Click Shut down in the Power menu that pops up.	Use the Windows Start menu in the lower left and follow the shutdown procedure.
Sleep	Press the power button* or use the Power menu to put the computer in Sleep mode.	Press the power button* or use the Windows Start menu to put the computer in Sleep mode.
Hibernate	By default, this option is not shown in the Power menu. If you want to use the feature, set up accordingly in Windows Control Panel .	Use the Windows Start menu to put the computer in Hibernation mode.

* "Sleep" is the default setting of the power button. You may change what the power button does in Windows **Control Panel**.

Taking a Look at the Computer

NOTE: Depending on the model you purchased, the appearance of your computer may not be exactly the same as those shown in this manual.

CAUTION: You need to open the protective covers to access the connectors. When not using a connector, make sure to close the cover completely for water-, dust-, and fire-proof integrity. (Engage the locking mechanism if existing.)

Front Components

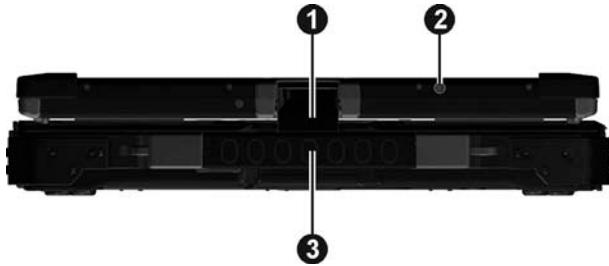

Ref	Component	Description	See Also
❶	Top Cover Latch	Locks the top cover.	P. 5
❷	WWAN Antenna	Should be pulled out for reception of mobile telecommunications signals.	P. 36
❸	Handle	Provides a convenient way to carry the computer.	

Rear Components

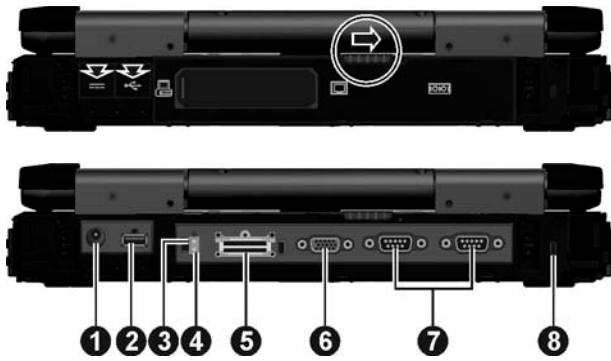

Ref	Component	Description	See Also
①	Power Connector	Connects the AC adapter.	P. 4
②	USB Port	Connects a USB device, such as a USB flash disk, printer, digital camera, joystick, and more.	P. 54
③	WWAN Pass-through Connector (option)	Connects the external antenna for WWAN (wireless wide area network) connectivity. NOTE: Must be connected via a docking station.	
④	GPS Pass-through Connector (option)	Connects the external antenna for GPS signal reception. NOTE: Must be connected via a docking station.	
⑤	Docking Connector	Connects to the office or vehicle dock (purchased separately).	
⑥	VGA Connector	Connects an external display monitor.	P. 51
⑦	Serial Connectors	Each of the two connectors connects a serial mouse or serial communication device.	P. 53

Ref	Component	Description	See Also
⑧	Kensington Lock	Locks the computer to a stationary object for security.	P. 89

Right-Side Components

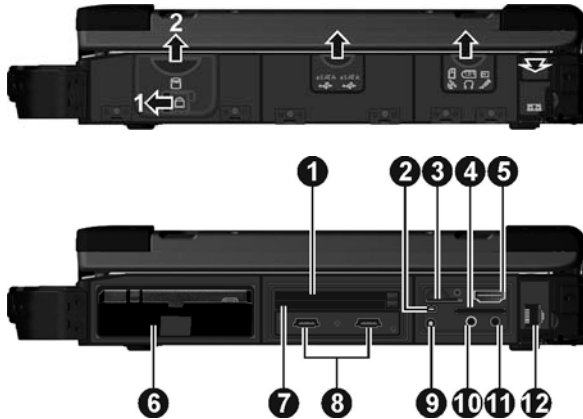

Ref	Component	Description	See Also
①	ExpressCard Slot	Accepts an ExpressCard for additional functions.	P. 60
②	Mini IEEE 1394 Port	Connects an IEEE 1394 device such as a scanner, printer, DVCAM, and VCR.	P. 56
③	SIM Card Slot (option)	Accepts a SIM card for models having the WWAN module. NOTE: The slot still exists but cannot be used for models without the WWAN module.	P. 37
④	SD Card Reader	Accepts a Secure Digital (SD) card for removable storage media.	P. 61
⑤	HDMI Connector	Connects a HDMI monitor or TV set.	P. 51
⑥	Hard Disk Drive	Inside is the hard disk drive.	P. 64

Ref	Component	Description	See Also
7	PCMCIA Slot	Accepts a PC card for additional functions.	P. 59
8	eSATA/USB Combo Port	Connects an eSATA device such as an external hard drive or optical drive.	P. 55
		Can also function as a USB port.	
9	GPS Antenna Connector	Connects the external antenna for GPS signal reception.	
10	Audio Output Connector	Connects a set of headphones or external speakers with amplifier.	P. 57
11	Microphone Connector	Connects an external microphone.	P. 57
12	RJ-45 Connector	Connects the LAN cable.	P. 32

Left-Side Components

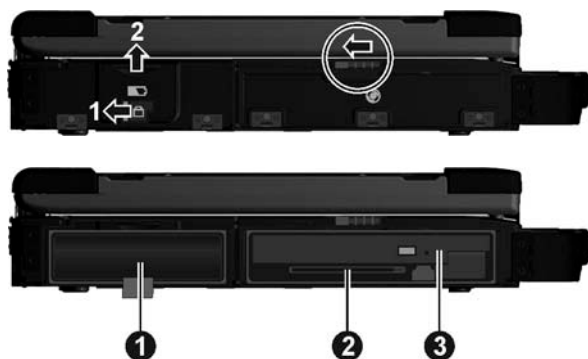







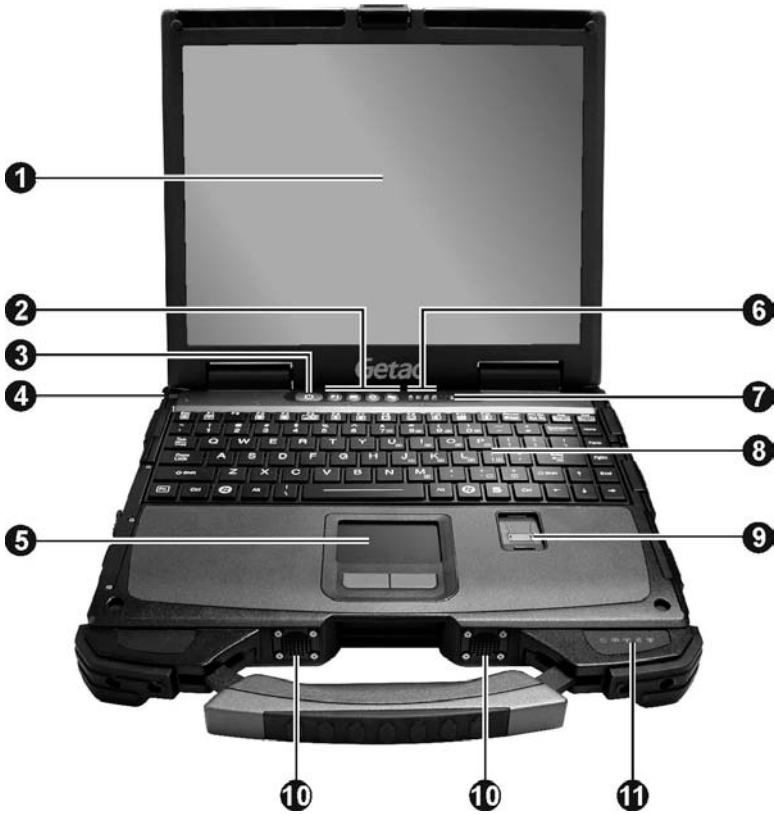

Ref	Component	Description	See Also
1	Battery Pack	Supplies power to your computer when external power is not connected.	P. 45
2	Smart Card Reader	Accepts a smart card for additional security feature.	P. 58





Ref	Component	Description	See Also
		<p>NOTE: On your computer, the Smart Card reader is a part of the super multi drive module. If the super multi drive module is replaced by a secondary battery pack or hard disk drive, you cannot use the Smart Card reader.</p>	
③	<p>Super Multi Drive</p>	<p>Accepts a compact disc for installing or loading software, accessing data, and playing music/video.</p>	<p>P. 29</p>
		<p>Can be replaced by a secondary hard disk drive or battery pack (purchased separately).</p>	<p>P. 64</p>

Top-open Components



Ref	Component	Description	See Also
1	LCD Screen	Displays the output of the computer. May include the optional touchscreen feature.	P. 25

Ref	Component	Description	See Also
2	Quick Buttons		P. 26
	P1	Toggles the “Blackout” mode on or off.	
		Brings up the ECO menu for selecting a power profile when using battery power.	
		Toggles the sunlight-readable mode on or off.	
		Enables or disables light sensor.	
3	Power Button 	Turns the power on or off. (The default “off” state is “Sleep mode.”)	P. 5
4	Stylus (option)	Serves as the input device by tapping on the screen to make selections and enter information.	P. 25
5	Touchpad	Serves as the pointing device of the computer.	P. 22
6	Indicators	Show the current status of the computer’s devices.	
	Hard Disk Drive / DVD Drive 	Blinks green when computer is accessing the hard disk or DVD drive.	
	Card Reader 	Blinks green when computer is accessing the storage card.	P. 61
	Caps Lock 	Lights green when Caps Lock is on.	P. 18
	Num Lock / HDD Heater (option) 	Lights green when Num Lock is on. Lights amber when the optional hard disk heater is on.	P. 18 P. 102
7	Microphone 	Receives sound and voice for the computer.	
8	Keyboard	Serves as the data input device of the computer.	P. 17

Ref	Component	Description	See Also
⑨	Fingerprint Scanner	Serves as the fingerprint verification, preventing unauthorized access to your computer.	P. 41
⑩	Stereo Speaker	Sends out sound and voice from the computer.	
⑪	Indicators	Show the current status of the computer's devices.	
	Power 	Lights green when computer is on.	P. 5
		Blinks green when computer is on Sleep mode.	
	Battery Charge 	Lights green when the battery is fully charged.	P. 45
		Lights amber when the battery is being charged.	
		Blinks red when the battery's capacity is below 10 %.	P. 47
		Blinks amber when the battery is in an abnormal condition.	
	WLAN 	Lights green when WLAN radio is on.	
Bluetooth 	Lights green when Bluetooth radio is on.		
WWAN 	Lights green when WWAN radio is on.		

Bottom Components



Ref	Component	Description	See Also
1	Memory Slots	Inside are the memory slots for expanding the memory size of your computer.	P. 62

Chapter 2

Operating Your Computer

This chapter provides information about the use of the computer.

If you are new to computers, reading this chapter will help you learn the operating basics. If you are already a computer user, you may choose to read only the parts containing information unique to your computer.

CAUTION:

- Do not expose your skin to the computer when operating it in a very hot or cold environment.
- The computer can get uncomfortably warm when you use it in high temperatures. As a safety precaution in such a circumstance, do not place the computer on your lap or touch it with your bare hands for extended periods of time. Prolonged body contact can cause discomfort and potentially a burn.

Using the Keyboard

Your keyboard has all the standard functions of a full-sized computer keyboard plus an **Fn** key added for specific functions.

The standard functions of the keyboard can be further divided into four major categories:

- Typewriter keys
- Cursor-control keys
- Numeric keys
- Function keys

Typewriter Keys

Typewriter keys are similar to the keys on a typewriter. Several keys are added such as the **Ctrl**, **Alt**, **Esc**, and lock keys for special purposes.

The Control (**Ctrl**) / Alternate (**Alt**) key is normally used in combination with other keys for program-specific functions. The Escape (**Esc**) key is usually used for stopping a process. Examples are exiting a program and canceling a command. The function depends on the program you are using.

Cursor-Control Keys

Cursor-control keys are generally used for moving and editing purposes.

NOTE: The word “cursor” refers to the indicator on the screen that lets you know exactly where on your screen anything you type will appear. It can take the form of a vertical or horizontal line, a block, or one of many other shapes.

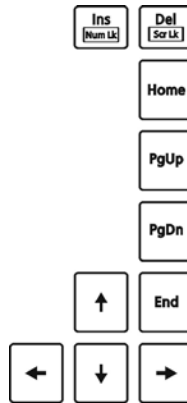

Numeric Keypad

A 15-key numeric keypad is embedded in the typewriter keys as shown next:

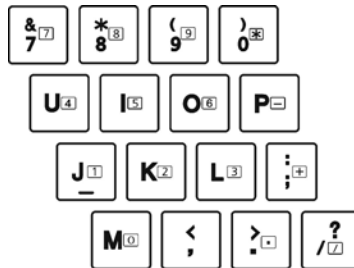

Numeric keys facilitate entering of numbers and calculations. When Num Lock is on, the numeric keys are activated; meaning you can use these keys to enter numerals.

NOTE:

- When the numeric keypad is activated and you need to type the English letter in the keypad area, you can turn Num Lock off or you can press **Fn** and then the letter without turning Num Lock off.
- Some software may not be able to use the numeric keypad on the computer. If so, use the numeric keypad on an external keyboard instead.

Function Keys

On the top row of the keys are the function keys: **F1** to **F12**. Function keys are multi-purpose keys that perform functions defined by individual programs.









Fn Key











The **Fn** key, at the lower left corner of the keyboard, is used with another key to perform the alternative function of a key. To perform a desired function, first press and hold **Fn**, then press the other key.

Hot Keys



Hot keys refer to a combination of keys that can be pressed any time to activate special functions of the computer. Most hot keys operate in a cyclic way. Each time a hot key combination is pressed, it shifts the corresponding function to the other or next choice.



You can easily identify the hot keys with the icons imprinted on the keytop. The hot keys are described next.

Key	Description
 	Switches the keyboard backlight on and off (option).
 	Switches the RF (radio frequency) radio on and off. When off, all wireless modules (such as WLAN, Bluetooth, and WWAN) cannot be used. When on, individual settings of the module work.
 	Switches the night vision feature on or off. The feature is for viewing the display when using night vision goggles (optional).
 	Decreases the sound volume.

Key	Description
	Increases the sound volume.
	<p>Switches the display output to the next choice if an external display (either VGA or HDMI) is connected. The hot keys are equivalent to  Windows logo key + P.</p> <p>Choices are:</p> <pre> graph TD A[LCD only] --> B[LCD + External display Duplicate] B --> C[LCD + External display Extend] C --> D[External display only] A --> D </pre>
	Decreases the LCD brightness. The LCD still has 2 nits brightness when you reach the lowest level.
	Increases the LCD brightness.
	Switches the touchscreen on or off (option).
	Switches the touchpad off or on.
	Switches the system sound output off (mute) or on.
	Switches the display on or off.
	Serves as the sleep button that you can define with Windows' Power Options .

Windows Keys

The keyboard has two keys that perform Windows-specific functions:  Windows Logo key and  Application key.

The  Windows Logo key opens the **Start** menu and performs software-specific functions when used in combination with other keys. The  Application key usually has the same effect as a right mouse click.

Using the Touchpad

CAUTION: Do not use a sharp object such as a pen on the touchpad. Doing so may damage the touchpad surface.

NOTE:

- Press **Fn+F9** to toggle the touchpad on or off.
- For optimal performance of the touchpad, keep your fingers and the pads clean and dry. When tapping on the pad, tap lightly. Do not use excessive force.

The touchpad is a pointing device that allows you to communicate with the computer by controlling the location of the pointer on the screen and making selection with the buttons.



The touchpad consists of a rectangular pad (work surface) and a left and right buttons. To use the touchpad, place your forefinger or thumb on the pad. The rectangular pad acts like a miniature duplicate of your display. As you slide your fingertip across the pad, the pointer (also called cursor) on the screen moves accordingly. When your finger reaches the edge of the pad, simply relocate yourself by lifting the finger and placing it on the other side of the pad.

Here are some common terms that you should know when using the touchpad:

Term	Action
Point	Move your finger on the pad until the cursor points to the selection on the screen.
Click	Press and release the left button. –or– Tap gently anywhere on the pad.
Double-click	Press and release the left button twice in quick succession. –or– Tap twice on the pad rapidly.
Drag and drop	Press and hold the left button, then move your finger until you reach your destination (drag). Finally, release the button (drop) when you finish dragging your selection to the destination. The object will drop into the new location. –or– Gently tap twice on the pad and on the second tap, keep your finger in contact with the pad. Then, move your finger across the pad to drag the selected object to your destination. When you lift your finger from the pad, the selected object will drop into place.
Scroll	To scroll is to move up and down or left and right in the working area on the screen. To move vertically, place your finger on the right or left edge of the pad and slide your finger up and down along the edge. To move horizontally, place your finger on the top or bottom edge of the pad and slide your finger left and right. This function may not work for all applications.

TABLE NOTE: If you swap the left and right buttons, “tapping” on the touchpad as an alternative method of pressing the left button will no longer be valid.

Configuring the Touchpad

You may want to configure the touchpad to suit your needs. For example, if you are a left-handed user, you can swap the two buttons so that you can use the right button as the left button and vice versa. You can also change the size of the on-screen pointer, the speed of the pointer, and so on.

To configure the touchpad, go to **Control Panel**:-

Using the Touchscreen (Optional)

NOTE:

- Touchscreen feature is currently not available for B300 Windows 8 models.
- Press **Fn+F8** to toggle the touchscreen on or off.

CAUTION: Do not use a sharp object such as a ballpoint pen or pencil on the touchscreen. Doing so may damage the touchscreen surface. Use your finger or the included stylus.

The touchscreen is a touch-sensitive device that allows you to navigate on the screen without using a keyboard, touchpad, or mouse.

Use the included stylus to select objects on the screen. The stylus can be stretched for better grip and handling.





The following table shows how you use the touchscreen to obtain equivalent mouse functions.



Term/Action	Equivalent Mouse Function
Tap: Touch the screen once.	Click/Point
Double-tap: Touch the screen twice rapidly.	Double-click
Tap and hold: Tap and hold until a popup menu appears.	Right-click
Drag: Hold the stylus (or finger) on the screen and drag across the screen until reaching your destination.	Drag

Using the Quick Buttons



Located on top of the keyboard are four quick buttons:

Button	Description
P1	<p>Toggles the Blackout mode on or off.</p> <p>In Blackout mode, the LCD backlight and LED indicators are turned off. To bring the computer out of Blackout mode, press P1 or the power button.</p> <p>NOTE: "Blackout" is the default setting of the P1 button. You can re-define the button. (See "P1 Quick Button Definition Utility" in Chapter 6 for information.)</p>
	<p>Brings up the ECO menu as shown below:</p>  <p>NOTE (for Windows 8): The popup menu is visible on Windows Desktop only.</p>

Button	Description
	<p>Select a mode before the ECO menu disappears. You can select a mode by pressing the ECO button or the arrow key. The ECO mode will return to the default Off setting when AC power is connected, any power related setting is changed, the computer resumes from Sleep/Hibernation mode, or the computer is restarted.</p> <p>Each ECO mode (Quick, Power Saving, or Work) is a combination of power settings that results in different power consumptions. (For information on configuring the ECO modes, see “ECO Tab” in Chapter 6.)</p> <p>NOTE: The button works only when using battery power.</p>
	<p>Toggles the sunlight-readable mode on or off.</p> <p>In sunlight-readable mode, the LCD brightness is increased to the highest level. The button lights green while in sunlight-readable mode.</p>
	<p>Enables or disables light sensor.</p> <p>When enabled, your computer automatically adjusts the LCD brightness based on the surrounding lighting condition. The button lights green while light sensor is enabled.</p>

Using the DVD Drive

Your computer may come with a Super Multi drive. The drive can read from and write to CD, DVD+, DVD- and DVD-RAM media.

CAUTION:

- When inserting a disc, do not use force.
- Make sure that the disc is correctly inserted into the tray, and then close the tray.
- Do not leave the drive tray open. Also, avoid touching the lens in the tray with your hand. If the lens becomes dirty, the drive may malfunction.
- Do not wipe the lens using materials with rough surface (such as paper towel). Instead, use a cotton swab to gently wipe the lens.

FDA regulations require the following statement for all laser-based devices: "Caution, Use of controls or adjustments or performance of procedures other than those specified herein may result in hazardous radiation exposure."

NOTE: The DVD drive is classified as a Class 1 laser product. This label is located on the DVD drive.



CLASS 1 LASER PRODUCT
LASER KLASSE 1

NOTE: For DVD and Combo drives only.

This product incorporates copyright protection technology that is protected by method claims of certain U.S. patents and other intellectual property rights owned by Macrovision Corporation and other rights owners. Use of this copyright protection technology must be authorized by Macrovision Corporation, and is intended for home and other limited viewing uses only unless otherwise authorized by Macrovision Corporation. Reverse engineering or disassembly is prohibited.

Inserting and Removing a Disc

Follow this procedure to insert or remove a disc:

1. Turn on the computer.
2. Open the multi-purpose bay cover by sliding the release latch towards the left.



3. Press the eject button and the DVD tray will slide out partially. Gently pull on it until it is fully extended.
4. To insert a disc, place down the disc in the tray with its label facing up. Slightly press the center of the disc until it clicks into place.

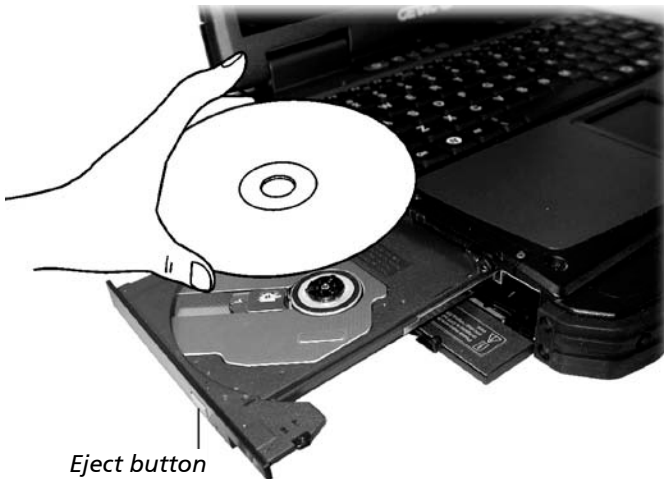

To remove a disc, hold the disc by its outer edge and lift it up from the tray.

5. Gently push the tray back into the drive.
6. Close the multi-purpose bay cover.

NOTE: In the unlikely event that you are unable to release the drive tray by pressing the eject button, you can manually release the disc. (See “Optical Drive Problems” in Chapter 8.)

Using the Network Features

Using the LAN

The internal 10/100/1000Base-T LAN (Local Area Network) module allows you to connect your computer to a network. It supports data transfer rate up to 1000 Mbps.



Using the WLAN

The WLAN (Wireless Local Area Network) module supports IEEE 802.11ac, compatible with 802.11a/b/g/n.

Turning On/Off the WLAN Radio

To turn on the WLAN radio:

1. Make sure that the Airplane mode is switched off. You can control the Airplane mode using one of the below methods.
 - Press **Fn+F1**.
 - **For Windows 8:** Open the Charms Bar, click **Settings** → **Change PC Settings** → **Network** → **Airplane mode**. Slide the **Airplane mode** switch to the **Off** position.
2. If you have previously turned off the WLAN radio, use one of the below methods to turn it on.
 - **For Windows 8:** Open the Charms Bar of Windows. Click **Settings** → **Change PC Settings** → **Network** → **Airplane mode**. Slide the **Wi-Fi** switch to the **On** position.

- **For Windows 7:** Use either Windows Mobility Center or Getac Quick Bar. To open Getac Quick Bar, right-click the Getac Utility icon  on Windows taskbar and select **Quick Bar**. Click the WLAN button in the Quick Bar (an X over the button means the radio is currently off).





To turn off the WLAN radio:

You can turn off the WLAN radio the same way you turn it on.

If you want to quickly turn off all wireless radio, simply switch on Airplane mode.

Connecting to a Wireless Network

1. Make sure that the WLAN function is enabled (as described above).
2. **For Windows 8:** Open the Charms Bar of Windows. Click **Settings** and then click .
- For Windows 7:** Click the Wireless Network icon  on the taskbar. (An orange light in the icon  indicates connections are available.)
3. In the list of available wireless networks, click a network, and then click **Connect**.
4. Some networks require a network security key or passphrase. To connect to one of those networks, ask your network administrator or Internet service provider (ISP) for the security key or passphrase.

For more information on setting a wireless network connection, refer to Windows online help.

NOTE: You can use Intel® PROSet Wireless to take full advantage of the Wi-Fi capabilities of your computer. See the Help of the utility for instructions.

Using the Bluetooth Feature

The Bluetooth 4.0 technology allows short-range (about 50 meters) wireless communications between devices without requiring a cable connection. Data can be transmitted through walls, pockets and briefcases as long as two devices are within range.

Turning On/Off the Bluetooth Radio

To turn on the Bluetooth radio:

1. Make sure that the Airplane mode is switched off. You can control the Airplane mode using one of the below methods.
 - Press **Fn+F1**.
 - **For Windows 8:** Open the Charms Bar, click **Settings** → **Change PC Settings** → **Network** → **Airplane mode**. Slide the **Airplane mode** switch to the **Off** position.
2. If you have previously turned off the Bluetooth radio, use one of the below methods to turn it on.
 - **For Windows 8:** Open the Charms Bar of Windows. Click **Settings** → **Change PC Settings** → **Network** → **Airplane mode**. Slide the **Bluetooth** switch to the **On** position.
 - **For Windows 7:** Use Getac Quick Bar. To open Getac Quick Bar, right-click the Getac Utility icon  on Windows taskbar and select **Quick Bar**. Click the Bluetooth button in the Quick Bar (an X over the button means the radio is currently off).



To turn off the Bluetooth radio:

You can turn off the Bluetooth radio the same way you turn it on.

If you want to quickly turn off all wireless radio, simply switch on Airplane mode.

Connecting to another Bluetooth Device

1. Make sure that the Bluetooth function is enabled (as described above).
2. Make sure that the target Bluetooth device is turned on, discoverable and within close range. (See the documentation that came with the Bluetooth device.)
3. **For Windows 8:** Open the Charms Bar of Windows. Click **Settings** → **Change PC Settings** → **PC and devices** → **Devices**. Click **Add a device**.

For Windows 7: Click and hold the Bluetooth icon  on Windows taskbar. Click **Add a Device**.

4. Select the device you want to connect from the search results.
5. Depending on the type of Bluetooth device that you want to connect to, you will need to enter the pertinent information.

For detailed information on using the Bluetooth feature, see Windows' online Help.

Using the WWAN Feature (Optional)

A WWAN (Wireless Wide Area Network) uses mobile telecommunication cellular network technologies to transfer data. The WWAN module of your computer supports 3G or 4G LTE depending on your model.

NOTE:

- The WWAN feature is available to selected countries only.
- Your model only supports data transmission, voice transmission is not supported.
- When using the WWAN feature, pull out the WWAN antenna.



Installing a SIM Card

1. Turn off the computer and disconnect the AC adapter.
2. Locate the SIM card slot on the right side of the computer and open the cover.
3. Unfasten one screw and remove the small plate that covers the SIM card slot.



4. Insert the SIM card into the slot. Make sure the beveled corner on the SIM card is facing towards the slot and that the golden contact area on the card is facing downwards.



5. Close the cover.

NOTE: To remove the SIM card, push inward to release and slide the SIM card out of the slot. You can use the small plate as a tool to push the SIM card.

Turning On/Off the WWAN Radio

To turn on the WWAN radio:

1. Make sure that the Airplane mode is switched off. You can control the Airplane mode using one of the below methods.
 - Press **Fn+F1**.
 - **For Windows 8:** Open the Charms Bar, click **Settings** → **Change PC Settings** → **Wireless**. Slide the **Airplane mode** switch to the **Off** position.
2. If you have previously turned off the WWAN radio, use one of the below methods to turn it on.
 - **For Windows 8:** Open the Charms Bar of Windows. Click **Settings** → **Change PC Settings** → **Network** → **Airplane mode**. Slide the **Mobile Broadband** switch to the On position.
 - **For Windows 7:** Use the WWAN utility software or Getac Quick Bar. To open Getac Quick Bar, right-click the Getac Utility icon  on Windows taskbar and select **Quick Bar**. Click the WWAN button in the Quick Bar (an X over the button means the radio is currently off).



To turn off the WWAN radio:

You can turn off the WWAN radio the same way you turn it on.

If you want to quickly turn off all wireless radio, simply switch on Airplane mode.

Setting up a WWAN Connection

1. Make sure that the SIM card is inserted and the WWAN function is enabled (as described above).
2. Start the WWAN utility software (**Skylight**).
3. You need to configure the software to match your mobile network operator.

Tap the  button to open the **User Options** window.

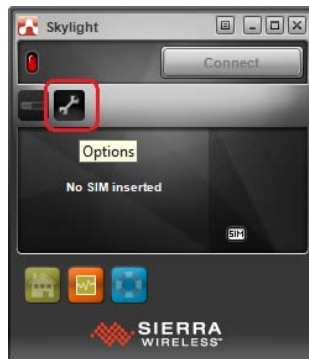

4. Select **Firmware** and pull down the list of mobile network operators.

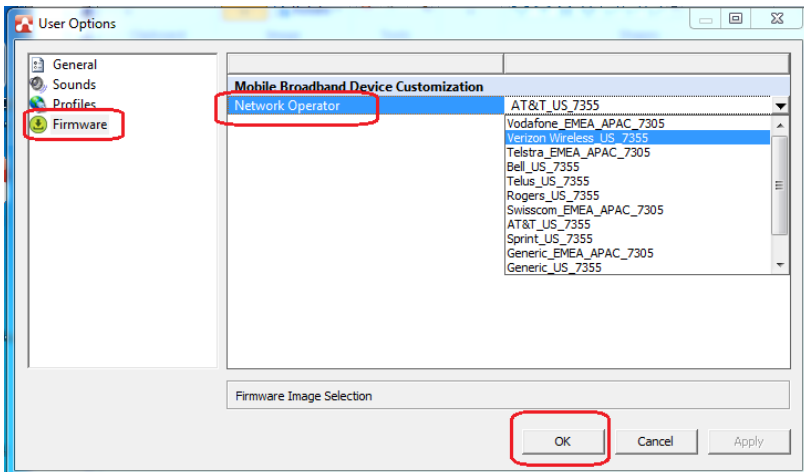

5. From the list, select the name that matches your operator and firmware.
 - **For the US region:** EM/MC7355 firmware is required. The supported operators include ATT, Bell, Roger, Sprint, Telus, and Verizon. If your operator is not one of them, select **Generic_US_7355** in the list.
 - **For the EMEA (Europe, the Middle East, and Africa) and APAC (Asia Pacific) regions:** EM/MC7305 firmware is required. The supported operators include Orange, Swisscom, Telefonica, Telstra, and Vodafone. If your operator is not one of them, select **Generic_EMEA_APAC_7305** in the list.
6. Select **OK** to start configuring mobile broadband device. A message bar appears on the screen to show the progress. Wait till the configuration is completed.

CAUTION: Do not perform other tasks or shut down the computer during the configuration process.

7. After the configuration, you can use WWAN connections. For more information, see the online help of the software.

Using the Fingerprint Scanner

WARNING:

- To protect the fingerprint scanner, be sure to slide close the cover when not using the fingerprint scanner.
- We shall not be liable for any loss or damage whatsoever resulting from your use of the fingerprint scanner or neglect of fingerprint scanner use, or any data loss resulting from such developments as fingerprint authentication malfunctioning.
- It is not recommended that you use the fingerprint scanner in a below-freezing temperature. The moisture on your finger can freeze to the scanner's metal surface when you touch it, resulting in a failed operation. Besides, touching freezing metal with your finger can cause frostbite.

The fingerprint scanner provides a strong authentication mechanism based on fingerprint recognition.

Locate and slide open the fingerprint scanner cover.



NOTE: You can enroll a fingerprint only after creating a password for the Windows user account.

To enroll your fingerprint:

For Windows 8

1. Open the Charms Bar, click **Settings** → **Change PC Settings** → **Accounts** → **Sign-in options**.
2. On the right side under **Fingerprint**, click **Add**.
3. Enter your user account password and click **OK**.
4. Follow the onscreen instructions to complete.

For Windows 7

1. Start **BioExcess**. Follow the wizard to enroll your fingerprints.
2. You can then use the fingerprint software to set up how the fingerprint authentication works. For detailed information, click the Help button of the software.



Chapter 3

Managing Power

Your computer operates either on external AC power or on internal battery power.

This chapter tells you how you can effectively manage power. To maintain optimal battery performance, it is important that you use the battery in the proper way.

AC Adapter

CAUTION:

- The AC adapter is designed for use with your computer only. Connecting the AC adapter to another device can damage the adapter.
- The AC power cord supplied with your computer is for use in the country where you purchased your computer. If you plan to go overseas with the computer, consult your dealer for the appropriate power cord.
- When you disconnect the AC adapter, disconnect from the electrical outlet first and then from the computer. A reverse procedure may damage the AC adapter or computer.
- When unplugging the connector, always hold the plug head. Never pull on the cord.

The AC adapter serves as a converter from AC (Alternating Current) to DC (Direct Current) power because your computer runs on DC power, but an electrical outlet usually provides AC power. It also charges the battery pack when connected to AC power.

The adapter operates on any voltage in the range of 100~240 V AC.

Battery Pack

The battery pack is the internal power source for the computer. It is rechargeable using the AC adapter.

NOTE: Care and maintenance information for the battery is provided in the “Battery Pack Guidelines” section in Chapter 7.

Charging the Battery Pack

NOTE:

- Charging will not start if the battery’s temperature is below 0 °C (32 °F) or above 40 °C (104 °F).
- The charging process will stop when the battery’s temperature gets above 60 °C (140 °F). The Battery Charge Indicator turns off in this state. Once the battery’s temperature drops within the safe range, charging will automatically resume with the Battery Charge Indicator glowing amber.
- During charging, do not disconnect the AC adapter before the battery has been fully charged; otherwise you will get a prematurely charged battery.

To charge the battery pack, connect the AC adapter to the computer and an electrical outlet. The Battery Charge Indicator () on the computer glows amber to indicate that charging is in progress. You are advised to keep the computer power off while the battery is being charged. When the battery is fully charged, the Battery Charge Indicator lights green.

It takes approximately 3.5~4.5 hours to fully charge the battery when the computer is off and 4~6 hours when the computer is on and in an idle state.

CAUTION: After the computer has been fully recharged, do not immediately disconnect and reconnect the AC adapter to charge it again. Doing so may damage the battery.

NOTE: The battery level may automatically lessen due to the self-discharge process (0.21 % per day), even when the battery pack is fully charged (100 %). This happens no matter if the battery pack is installed in the computer.

Initializing the Battery Pack

You need to initialize a new battery pack before using it for the first time or when the actual operating time of a battery pack is much less than expected. Initializing is the process of fully charging, discharging, and then charging. It can take several hours.

A tool called “Gauge Reset” is provided for the purpose. See “Gauge Reset” in Chapter 6 for information on using the tool.

Checking the Battery Level

NOTE: Any battery level indication is an estimated result. The actual operating time can be different from the estimated time, depending on how you are using the computer.

The operating time of a fully charged battery pack depends on how you are using the computer. When your applications often access peripherals, you will experience a shorter operating time.

By Operating System

You can find the battery icon on the Windows taskbar (lower-right corner). The icon shows the approximate battery level.

By Gas Gauge

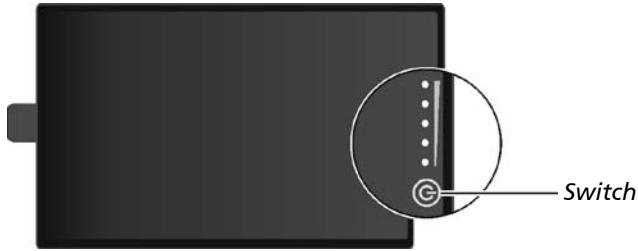

On the exterior side of the battery pack is a gas gauge for displaying the estimated battery charge. When the battery pack is not installed in the computer and you want to know the battery charge, you can press the switch with a pointed device to see the corresponding value of indicator segment that light green.



The value of the corresponding green segment indicates the relative percentage of the battery charge. The battery pack is fully discharged when you see no segment glowing green

Battery Low Signals and Actions

The battery icon  changes appearance to display the current state of the battery.

Battery Icon	Battery Level	Description
	Discharging	The icon shows the charge remaining in 10-percent increments until the charge reaches the low-battery level.
	Low	The battery charge has reached the low-battery level (10% by default).
	Critically low	The battery charge has reached the critical battery level (5% by default). By default, Windows will display a notification and put your computer into Hibernation.

When the battery is low, the computer's Battery Charge Indicator () also blinks red to alert you to take actions.

Always respond to low-battery by connecting the AC adapter, placing your computer in Hibernation mode, or turning off the computer.

Replacing the Battery Pack

CAUTION:

- There is danger of explosion if the battery is incorrectly replaced. Replace the battery only with the computer manufacturer's optional battery packs. Discard used batteries according to the dealer's instructions.
- Do not attempt to disassemble the battery pack.

1. Turn off the computer and disconnect the AC adapter.
2. Locate the battery compartment on the left side of the computer.
3. Slide the cover lock to the left (❶) and then lift the release latch (❷) to open the compartment cover.



4. Pull the ribbon strip and slide the battery pack out of the compartment.



5. With the ribbon strip facing outward, insert the new battery pack all the way into the compartment.
6. Close the cover, press the release latch downward to engage, and then slide the lock towards the right to secure the cover.

Power-Saving Tips

Aside from enabling your computer's power saving mode, you can do your part to maximize the battery's operating time by following these suggestions.

- Do not disable Power Management.
- Decrease the LCD brightness to the lowest comfortable level.
- Shorten the length of time before Windows turn off the display.
- When not using a connected device, disconnect it.
- Remove the card (such as PC card, ExpressCard, and Smart Card) if not using it.
- Turn off the wireless radio if you are not using the wireless module (such as WLAN, Bluetooth, or WWAN).
- Turn off the computer when you are not using it.

Chapter 4

Expanding Your Computer

You can expand the capabilities of your computer by connecting other peripheral devices.

When using a device, be sure to read the instructions accompanying the device together with the relevant section in this chapter.

Connecting a VGA or HDMI Display Monitor

If you want the benefits of a larger display screen with higher resolution, you can connect an external display monitor to your computer

Your computer supports a VGA connector and a HDMI connector. HDMI (High-Definition Multimedia Interface) is an audio/video interface that transmits uncompressed digital data and therefore delivers true HD quality.

Follow this procedure to connect an external monitor:

1. Turn off the computer.
2. Depending on the type of your monitor, plug the monitor's signal connector to the computer's VGA or HDMI connector.

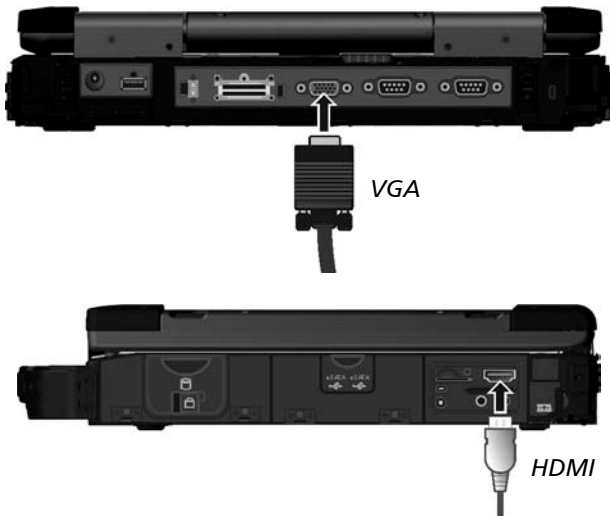

3. Plug one end of the monitor's power cord into the power socket on the monitor and the other end to an electrical outlet.
4. To use the monitor, turn on the monitor before turning on the computer.

5. The connected device should respond by default. If not, you can switch the display output by pressing the **Fn+F5** hot keys. (You can also change the display through Windows **Control Panel**.)

CAUTION: Do not disconnect the external monitor while the computer is in the Sleep mode or Hibernation mode. If no external monitor is connected when the computer resumes, the LCD might not display properly.

Connecting a Serial Device

Your computer has two serial ports for connecting a serial device such as a serial mouse or serial communication device (modem).

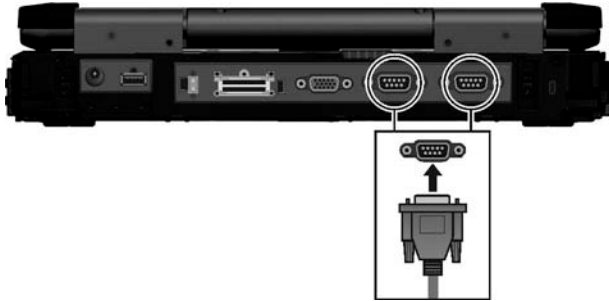

NOTE: Portable modems that derive power through the serial port cannot be used with the computer. Instead, use a modem that is powered by its own internal battery or external AC power.

Connecting a USB Device

Your computer has one USB 3.0 port and two eSATA/USB 3.0 ports for connecting USB devices, such as a digital camera, scanner, printer, modem, and mouse.

The USB ports support transfer rate up to 5.0 Gbit/s for USB 3.0 devices.

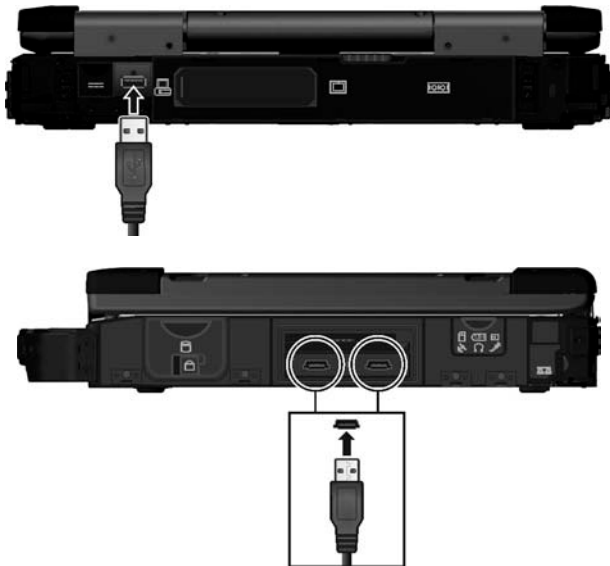

Connecting an eSATA Device

Your computer has two eSATA/USB combo ports for connecting eSATA devices (such as an external hard drive and external optical drive) / USB devices (see previous section).

The port supports SATA II with transfer rate up to 3.0Gbit/s. It can provide 5V power if a certified USB-eSATA combo cable is used.

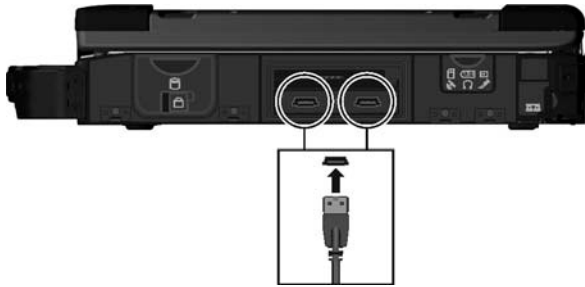

Connecting Audio Devices

For higher audio quality, you can send or receive sound through external audio devices.

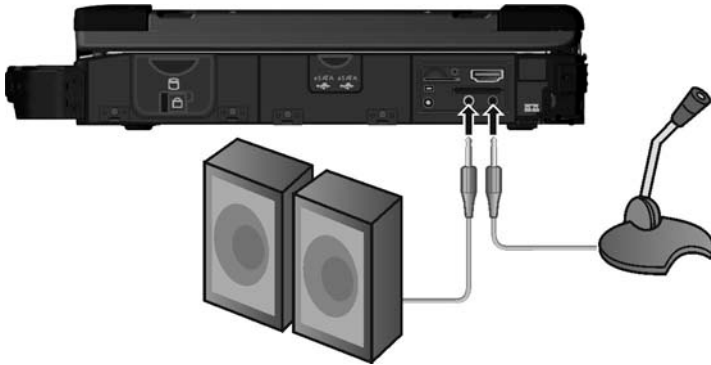

- **Audio Output Connector** (green) can be connected to speakers, headphones, or earphone set.
- **Microphone Connector** (pink) can be connected to an external microphone for recording voice or sound.

NOTE:

- After connecting an external audio device, make sure that you specify the use of the correct audio device in Windows.
- When using the external speakers/headphones or microphone, you cannot use the internal one.

Using Smart Cards

NOTE: On your computer, the Smart Card reader is a part of the super multi drive module. If the super multi drive module is replaced by a secondary battery pack or hard disk drive, you cannot use the Smart Card reader.

With an embedded microcontroller, smart cards have the unique ability to store large amounts of data, carry out their own on-card functions (e.g., encryption and mutual authentication), and interact intelligently with a smart card reader.

To insert a smart card:

1. Locate the smart card slot on the left of the computer and open the cover.
2. Slide the smart card, with its label and embedded computer chip facing up into the slot.

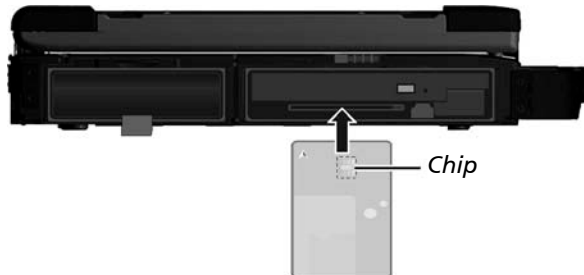

To remove a smart card:

1. Make sure that the third-party smart card software is not accessing the smart card.
2. Pull the card out of the slot.
3. Close the cover.

Using PC Cards

NOTE:

- Some PC cards require additional system resources. Before using such PC card, you may have to free other system resources for the PC card.
- Although some PC cards can be inserted and removed without turning off the computer, you cannot remove or install PC cards during Sleep mode.

Your computer has one PC card slot which supports type II card and CardBus specifications.

To insert a PC card:

1. Locate the PC card slot on the right side of the computer and open the cover.
2. Slide the PC card, with its label facing up, into the slot until the eject button pops out.

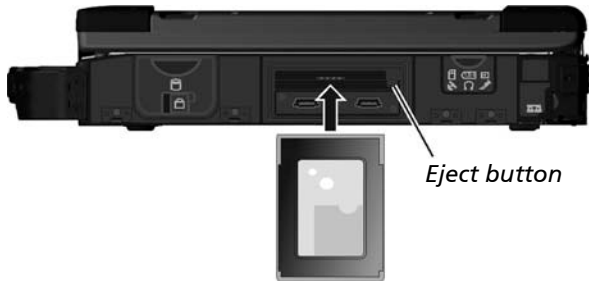

To remove a PC card:

1. Double-click the **Safely Remove Hardware**  icon found on the Windows taskbar and the **Safely Remove Hardware** window appears on screen.
2. Select (highlight) the PC card from the list to disable the card.
3. Push the eject button and the card will slide out slightly.
4. Pull the card out of the slot.
5. Close the cover.

Using ExpressCards

Your computer has an ExpressCard slot.

The ExpressCard slot can accommodate a 54 mm (ExpressCard/54) or 34 mm (ExpressCard/34) wide ExpressCard. Typical ExpressCards support a very extensive range of applications including memory, wired and wireless communication cards, and security devices.

To insert an ExpressCard:

1. Locate the ExpressCard slot on the right side of the computer and open the cover.
2. Slide the ExpressCard, with its label facing up, all the way into the slot until the rear connectors click into place.



To remove an ExpressCard:

1. Double-click the **Safely Remove Hardware**  icon found on the Windows taskbar and the **Safely Remove Hardware** window appears on screen.
2. Select (highlight) the ExpressCard from the list to disable the card.
3. Push the eject button and the card will slide out slightly.
4. Pull the card out of the slot.
5. Close the cover.

Using Storage Cards

NOTE: You can use only storage cards. Your Card Reader does not support cards with I/O (input/output) functions such as a wireless network card or Bluetooth card.

Your computer has a storage card reader. The card reader is a small drive for reading from and writing to removable storage cards (or called memory cards). The reader supports SD (Secure Digital) cards.

To insert a storage card:

1. Locate the SD card reader on the right side of the computer and open the cover.
2. Align the card with its connector pointing to the slot and its label facing down. Slide the card into the slot until it reaches the end.



3. Windows will detect the card and assign it a drive name.

To remove a storage card:

1. Open **File Explorer** and click **Computer**.
2. Right-click the drive with the card and select **Eject**.
3. Slightly push the card to release and then pull it out of the slot.
4. Close the cover.

System Memory Upgrade

You can upgrade your computer by expanding system memory.

CAUTION:

- It is not recommended that you buy and install RAM modules by yourself. If you want to expand system memory, please ask Getac service center to install DRAM modules for you so that full compatibility can be guaranteed.
- RAM modules are extremely sensitive to static electricity. There are cases where static electricity generated by the human body has adversely affected such modules. When inserting or removing a RAM module, do not touch the terminals or internal components, insert objects other than the module, or allow foreign particles to enter. Doing so has been known to cause damage, fire, or electrical shock.

To install the RAM module:

1. Disconnect the AC adapter and remove the battery pack (see chapter 3).
2. Carefully place the computer upside down.
3. Remove the six screws to open the compartment cover.

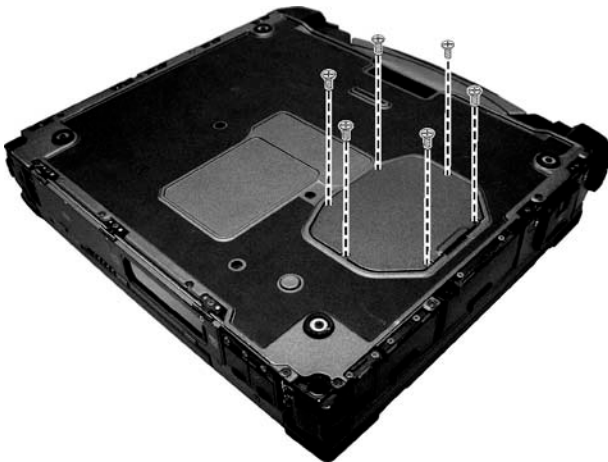

4. To install the RAM module, match the module's notched part with the socket's projected part and firmly insert the module into the socket at a 20-degree angle (❶). Then push down until the retaining clips lock the module into position (❷).

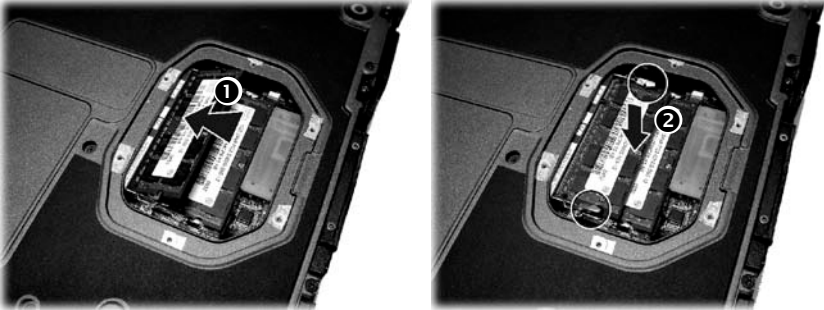

CAUTION: If the RAM module is difficult to insert or difficult to push down, do not force it. Check once more to ensure that the module is positioned correctly.

5. Close the compartment cover and secure with six screws.
6. Replace the battery pack.

Replacing the Hard Disk Drive

1. Disconnect the AC adapter and remove the battery pack (see chapter 3).
2. Locate the hard disk drive compartment on the right side of the computer. Slide the cover lock to the left (❶) and then lift the release latch (❷) to open the compartment cover.



3. Pull the strip and slide the hard disk drive out of the slot.



4. With the strip facing outward, insert the new hard disk drive all the way into the slot.
5. Close the cover, press the release latch downward to engage, and then slide the lock towards the right to secure the cover.
6. Replace the battery pack.

Installing a Secondary Battery Pack or Hard Disk Drive

You can purchase a secondary battery pack or hard disk drive to be installed in the multi-purpose bay.

1. Make sure that system power is off.
2. Open the multi-purpose bay cover by sliding the release latch towards the left.



3. Press upward the release latch (1) and pull the ribbon strip (2) to slide the existing device out of the bay.



4. With the ribbon strip facing outward, insert the new device all the way into the media bay.



5. Close the multi-purpose bay cover.

Chapter 5

Using BIOS Setup

BIOS Setup Utility is a program for configuring the BIOS (Basic Input/ Output System) settings of the computer. BIOS is a layer of software, called firmware, that translates instructions from other layers of software into instructions that the computer hardware can understand. The BIOS settings are needed by your computer to identify the types of installed devices and establish special features.

This chapter tells you how to use the BIOS Setup Utility.

When and How to Use

You need to run BIOS Setup Utility when:

- You see an error message on the screen requesting you to run BIOS Setup Utility.
- You want to restore the factory default BIOS settings.
- You want to modify some specific settings according to the hardware.
- You want to modify some specific settings to optimize the system performance.

To run BIOS Setup Utility:

1. **Method 1 for Windows 8 models:** Open the Charms Bar of Windows. Click **Settings** → **Change PC Settings** → **Update and recovery** → **Recovery**. Under **Advanced startup**, click **Restart now**. In the boot options menu, click **Troubleshoot** → **Advanced options** → **UEFI Firmware Settings**. Click **Restart** to restart the system and enter UEFI (BIOS).

Method 2 for Windows 8 models: Restart the computer using the **Restart** option in Windows Power menu. Or, perform a full shutdown by holding down **Shift** while clicking the **Shutdown** option in Windows Power menu and then start up the computer. In either way, press the **F2** key during the brief time period – shortly after the computer powers on but before it begins to load Windows.

For Windows 7 models: Press the **F2** key when the prompt appears on the screen during system startup.

2. The BIOS Setup Utility main screen appears.

In general, you can use the arrow keys to move around and + / – keys to change the setup values. Keyboard information can be found at the bottom of the screen.

NOTE: The actual setting items on your model may differ from those described in this chapter.

Menu Descriptions

Information Menu

The Information menu contains the basic configuration information of the system. There are no user-definable items in this menu.

NOTE: The “Asset Tag” information appears when you have entered the asset number for this computer using the asset management program. The program is provided in the **Asset tag** folder of the Driver disc.

Main Menu

The Main menu contains the various system settings.

- **System Date** sets the system date.
- **System Time** sets the system time.
- **Legacy USB Support** enables or disables the system’s support for Legacy USB device in DOS mode.
- **CSM Support** enables or disables CSM (Compatibility Support Mode). You can set this item to Yes for backward compatibility with legacy BIOS services. (This item appears only on Windows 8 models.)
- **UEFI Boot** enables or disables booting using UEFI (Unified Extensible Firmware Interface). UEFI is a new type of firmware after the BIOS firmware. (This item appears only on Windows 8 models.)
- **Legacy Boot** enables or disables booting using legacy BIOS. This item is accessible only when the **CSM Support** item is set to Yes. (This item appears only on Windows 8 models.)

Advanced Menu

The Advanced menu contains the advanced settings.

- **CD/DVD Auto Power Control** sets if power to the CD/DVD drive is controlled for energy saving. When set to *ZPODD* (Zero Power Optical Disc Drive), power will not be supplied to the drive when there is no CD/DVD in the drive. When set to *ODD Door*, power will not be supplied to the drive when there is no CD/DVD in the drive and the protective door of the drive is closed.
- **Wake Up Capability** specifies events for waking up the system from S3 (Sleep) state.
Any-key Wake Up From S3 allows any key to wake up the system from S3 (Sleep) state.
USB Wake-Up From S3 allow a USB device activity to wake up the system from S3 (Sleep) state.
- **System Policy** sets the system performance. When set to *Performance*, the CPU always runs at full speed. When set to *Balance*, the CPU speed changes according to the current workload, therefore balancing between performance and power consumption.
- **AC Initiation** sets if connecting AC power will automatically start or resume the system.
- **SATA Mode** set to *AHCI* if your hard disk supports AHCI. AHCI allows you to take advantage of Advanced Host Controller Interface features. The options are *IDE* and *AHCI*.

CAUTION: Incorrect SATA mode settings can result in hard disk drive boot failure.

- **AMT Configuration** configures Active Management Technology parameters.
Intel AMT enables or disables Intel® Active Management Technology BIOS extension execution. AMT allows the system administrator to access an AMT featured computer remotely.
Intel AMT Setup Prompt determines whether the prompt for entering Intel AMT Setup appears or not during POST. If disabled, users cannot enter Intel AMT Setup.

- **Virtualization Technology Setup** sets Virtualization Technology parameters.
Intel(R) Virtualization Technology enables or disables Intel® VT (Intel Virtualization Technology) feature which provides hardware support for processor virtualization. When enabled, a VMM (Virtual Machine Monitor) can utilize the additional hardware virtualization capabilities provided by this technology.
Intel(R) VT for Directed I/O (VT-d) enables or disables VT-d (Intel® Virtualization Technology for Directed I/O). When enabled, VT-d helps enhance Intel platforms for efficient virtualization of I/O devices.
- **Graphic Setup** sets graphics related options.
DVMT Pre-Allocated sets the amount of pre-allocated (fixed) graphics memory for use by the internal graphics device.

NOTE: Graphic Setup parameters apply to the internal graphics device only.

- **Button Setup**
P1 Function specifies the **P1** quick button function. When set to *Blackout*, the **P1** quick button allows you to turn off the LCD backlight and LED indicator. When set to *Quick Btn*, the **P1** quick button functions as a user customized quick launch key. When set to *Emergency Btn*, the **P1** quick button serves as the Emergency button. ("Emergency button" only works with customized applications that support the specific button.)
- **Device Configuration** enables or disables several hardware components. The items available for setting depend on your model.

Security Menu

The Security menu contains the security settings, which safeguard your system against unauthorized use.

NOTE:

- You can set the user password only when the supervisor password has been set.
- If both the administrator and user passwords are set, you can enter any of them for starting up the system and/or entering BIOS Setup. However, the user password only allows you to view/change the settings of certain items.
- A password setting is applied right after it is confirmed. To cancel a password, leave the password empty by pressing the **Enter** key.
- **Secure Boot Configuration** You can access this item only after setting the **Supervisor Password**. (This item appears only on Windows 8 models.) **Secure Boot Option** enables or disables Secure Boot. Secure Boot is a feature that helps prevent unauthorized firmware, operating systems, or UEFI drivers from running at boot time. **Reset to Default** resets secure boot variables to manufacturing default. **Change to Customization** changes the platform to setup mode and disables Secure Boot.
- **Set Supervisor/User Password** sets the supervisor/user password. You can set the supervisor/user password to be required for starting up the system and/or entering BIOS Setup.
- **Password on Boot** allows you to enable or disable the entering of password for booting up your system.
- **Set HDD 0 Password** sets the password for locking the Primary Master hard disk drive. After setting a password, the hard disk drive can only be unlocked by the password no matter where it is installed.
- **TPM Setup Menu** sets various TPM parameters. **TPM Support** enables or disables TPM support. TPM (Trusted Platform Module) is a component on your computer's mainboard that is specifically designed to enhance platform security by providing a protected space for key operations and other security critical tasks.

Change TPM State allows you to select between *No Change, Clear, Enable and Activate, and Disable and Deactivate.*

Boot Menu

The Boot menu sets the sequence of the devices to be searched for the operating system. (See the information on the right side of the menu for keyboard usage.)

Exit Menu

The Exit menu displays ways of exiting BIOS Setup Utility. After finishing with your settings, you must save and exit so that the changes can take effect.

- **Exit Saving Changes** saves the changes you have made and exits BIOS Setup Utility.
- **Exit Discarding Changes** exits BIOS Setup Utility without saving the changes you have made.
- **Load Setup Defaults** loads the factory default values for all the items.
- **Discard Changes** restores the previous values for all the items.
- **Saves Changes** saves the changes you have made.

Quick BIOS Settings

During POST, you can quickly access specific BIOS settings using the hot keys as described below.

Keys	Functions
F10	Opens the Boot menu where you can specify the device to boot from.
F12	Enables LAN boot.
Ctrl + P	Opens Intel® ME setup (MEBx) menu where you can change the Intel® Management Engine settings for the computer. NOTE: The MEBx is intended for use by advanced users. Making changes in the MEBx configuration program can cause system problems. The MEBx configuration should only be changed from default settings to address a specific need.
Ctrl + Alt + F1	Enables Intel® vPRO Remote Assistance to allow remote configuration. The actual behavior depends on MEBx settings.
Esc	Switches to text mode for displaying POST messages, useful for maintenance purposes.

Chapter 6

Using Getac Software

Getac software includes application programs for specific computer components and utility programs for overall management.

This chapter describes how to use the programs.

G-Manager

G-Manager is a unified user interface utility that allows you to manage and configure the following:

- System
- Battery
- ECO
- Light Sensor
- Antenna
- Monitoring
- GPS Status

Right-click the Getac Utility icon () located on Windows taskbar and select **G-Manager**.

The G-Manager window appears, containing 7 tabs as described later.

NOTE: Depending on your model, the actual items appearing on the screen may differ from those shown in this manual.

System Tab

The **System** tab provides system information.

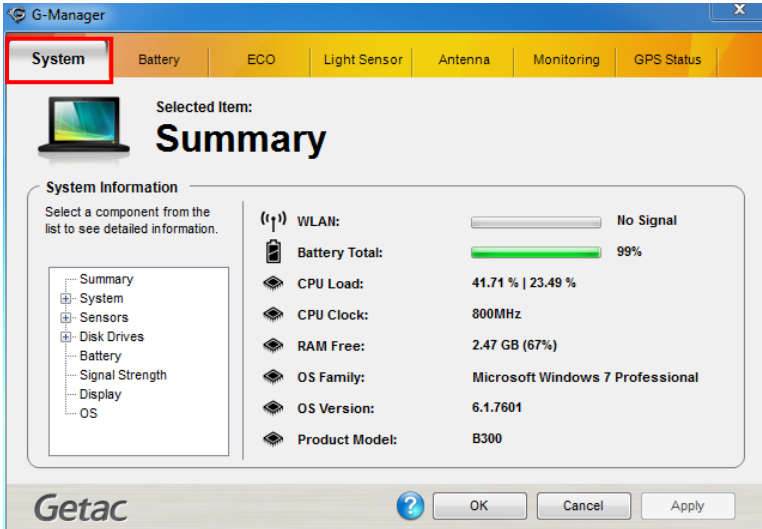

To view specific information, select the component from the list on the left side of the screen. The information of the selected component will be displayed on the right side of the screen.

Battery Tab

The **Battery** tab allows you to check the battery status and configure the battery.

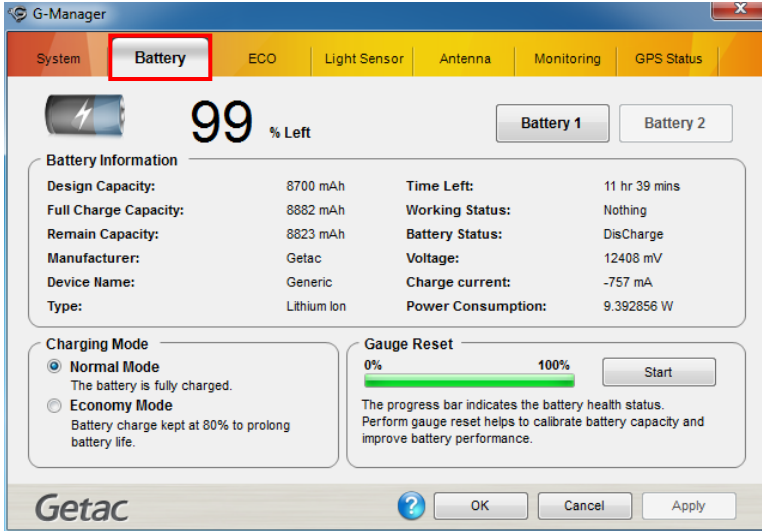

The battery items shown in the screen depend on your computer model. You may see up to two battery items (**Battery 1** and **Battery 2**). Click a battery item to view the information of the selected battery. Batteries not installed in your computer are grayed-out.

Battery Information

The upper portion of the screen displays the current status of the selected battery.

NOTE:

- If the AC adapter is connected, some information is not shown.
- When the percentage % Left is less than 10% then the value will be displayed in red.
- When an abnormal battery condition is detected, the battery information values will be displayed in red.

Charging Mode

The lower left portion of the screen allows you to select the charging mode.

- **Normal Mode** – The battery will be fully charged. When remaining charge reaches below 95%, then charging will start until it is fully charged.
- **Economy Mode** – This mode helps prolong battery life by charging up to 80% of its total capacity only. It is highly recommended if you are using AC power most of the time.

Gauge Reset

The lower right portion of the screen contains the battery health bar and provides the battery calibration function.

The health bar shows the batter's health by percentage. A low percentage indicates poor health and therefore the need to perform a gauge reset to calibrate the battery's capacity and improve the battery's performance. The gauge reset process includes discharging and then fully recharging the battery in two cycles. It can take several hours.

To perform a gauge reset:

1. Connect the AC adapter.
2. Click **Start**, located next to the health bar
3. In the pop-up dialog box, click **Yes** to start the process. The window as below appears displaying the progress bar.

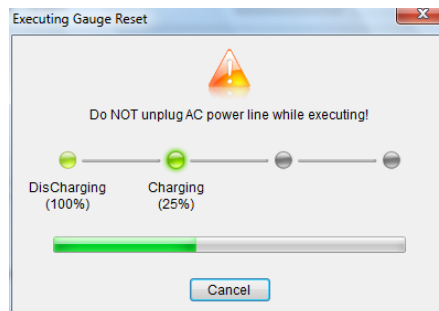

4. Wait till the process is completed. Click **Exit** when finished.

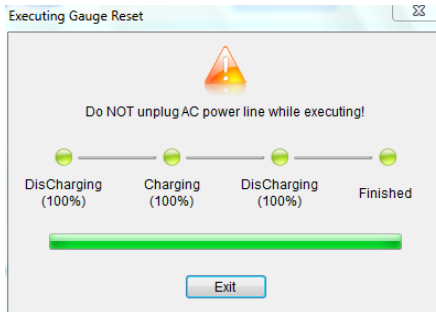

ECO Tab

The **ECO** tab allows you to configure ECO modes (or called power profiles).

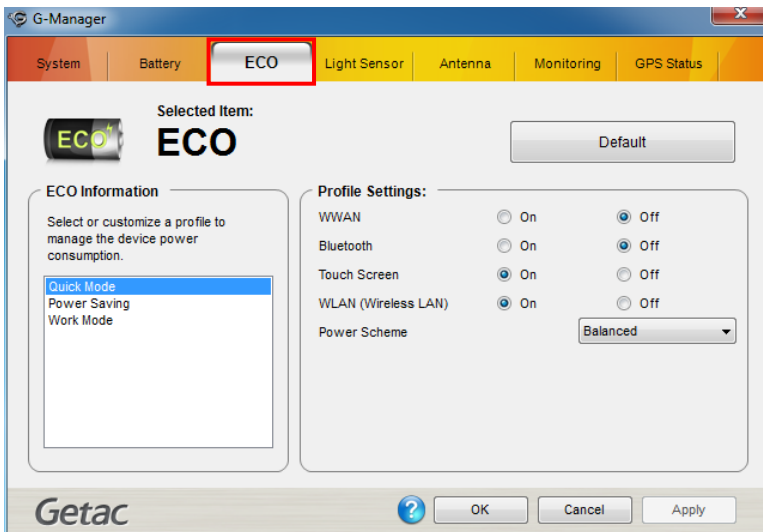

To put the system into an ECO mode, use the **ECO** button. (See "Using the Quick Buttons" in Chapter 2 for information.)

ECO Information

The left portion of the screen lists the available power profiles (**Quick**, **Power Saving**, and **Work**). Each profile is a combination of power settings that results in different power consumptions. To change the settings of a profile, select (highlight) the profile name in the list.

Profile Settings

The right portion of the screen displays the settings of the current selected profile. You can set up the following items:

- **WWAN, Bluetooth, Touchscreen, and WLAN** – can be on or off.
- **Power Scheme** – can be **Balanced**, **High Performance** or **Power Saver**. The settings here correspond to the settings in Windows. (See Windows Help for the description to each of the power scheme.)

After changing the settings, click **Apply** or **OK** to save the changes. To restore the settings to the default values, click **Default**.

Light Sensor Tab

The **Light Sensor** tab allows you to enable automatic keyboard backlight.

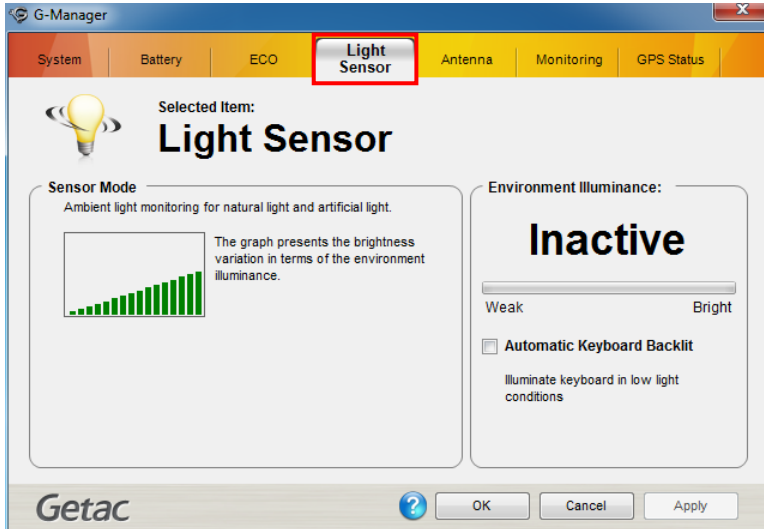

To have the keypad backlight automatically turn on in poor lighting environment, click the checkbox **Automatic Keyboard Backlit**. Click **Apply** or **OK** to save the changes.

Antenna Tab

The **Antenna** tab allows you to set if your system will automatically use the external GPS or WWAN antenna when connected.

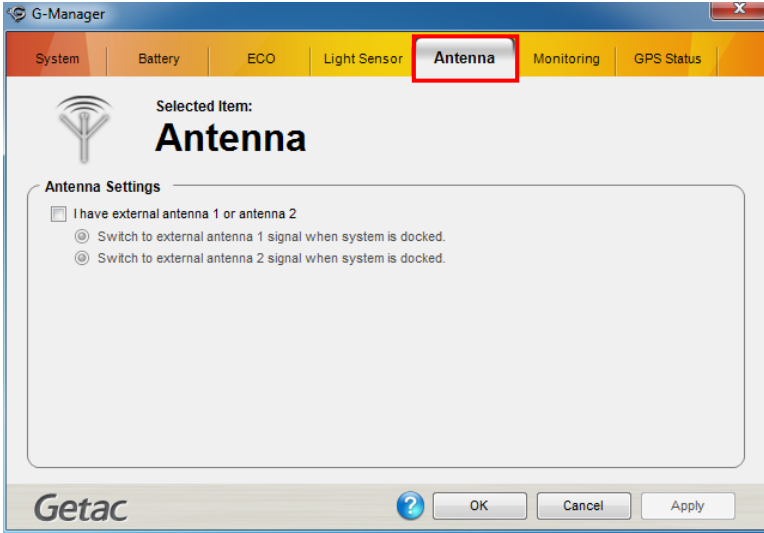

Select the checkbox(es) accordingly. Click **Apply** or **OK** to save the changes.

Monitoring Tab

The **Monitoring** tab allows you to configure the monitoring function of G-Manager.

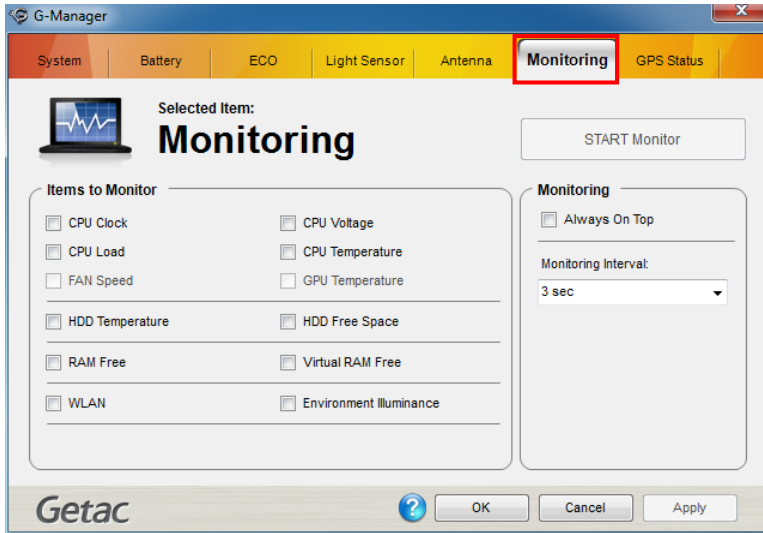

Items to Monitor

The left portion of the screen lists the items. Click the checkbox before an item to include it as a monitored component. Click **Apply** or **OK** to save the changes.

NOTE: Different models have different supported monitoring items; non-supported items cannot be selected (grayed out items).

Monitoring Options

The right portion of the screen allows you to set how the monitored items are displayed and how often the monitoring is updated.

- **Always On Top** – allows the monitoring window to remain on top of your display.

- **Monitoring Interval** – sets the frequency of updates on the monitoring window (1/3/5/10/30 seconds or 1/5/30 minutes).

Click **Apply** or **OK** to save the changes.

Starting and Stopping the Monitoring

To start monitoring, click **START Monitor**. The monitoring window similar to the one below appears displaying requested information at specified intervals.

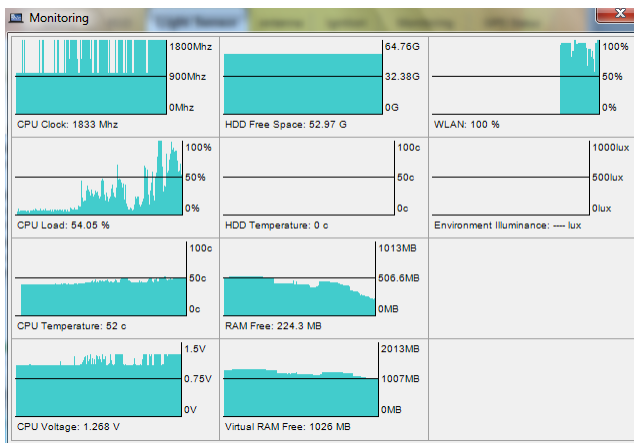

To stop monitoring, click the Close button at the upper right corner of the monitoring window or click **Stop Monitor** on the **Monitoring** tab page of G-Manager.

GPS Status Tab

The **GPS Status** tab shows the GPS status for models having the GPS module.

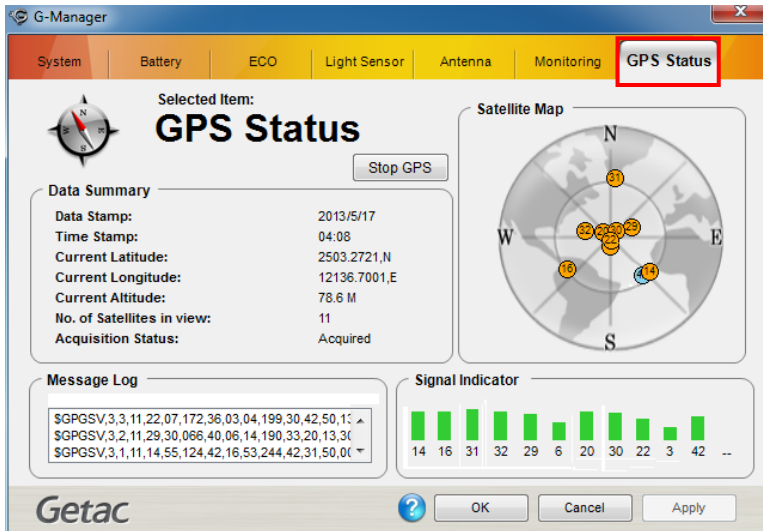

To start GPS positioning, click **Start GPS**. The screen displays:



- Ongoing raw data strings in the **Message Log** section
- Overhead satellite positions in the **Satellite Map** section
- Signal strength of the satellites in the **Signal Indicator** section

When GPS positioning is completed, the **Data Summary** section shows the GPS information of the current location.

To stop GPS positioning, click **Stop GPS**.

P1 Quick Button Definition Utility

The **P1** button has a pre-assigned function. You can re-define the button following this procedure:

1. Run BIOS Setup program to select *Quick Btn* for the **P1 Function** item under the Advanced menu. (See "Advanced Menu" in Chapter 5.) Save and exit the program.
2. Right-click the Getac utility icon () on the Windows taskbar and select **Quick Button Definition**.
3. The following window appears. To assign a program to a button, click the **Open** button .

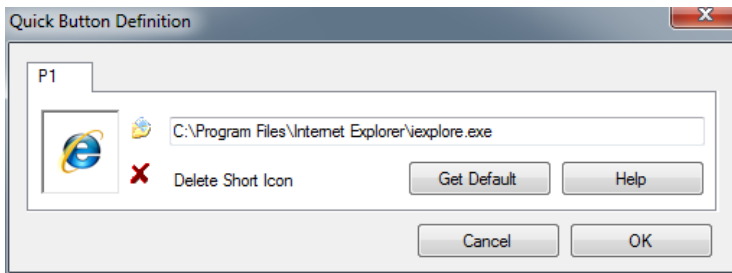

4. In the **Open** dialog box, browse to the destination folder and select the desired program file. Then, click **Open** to complete.

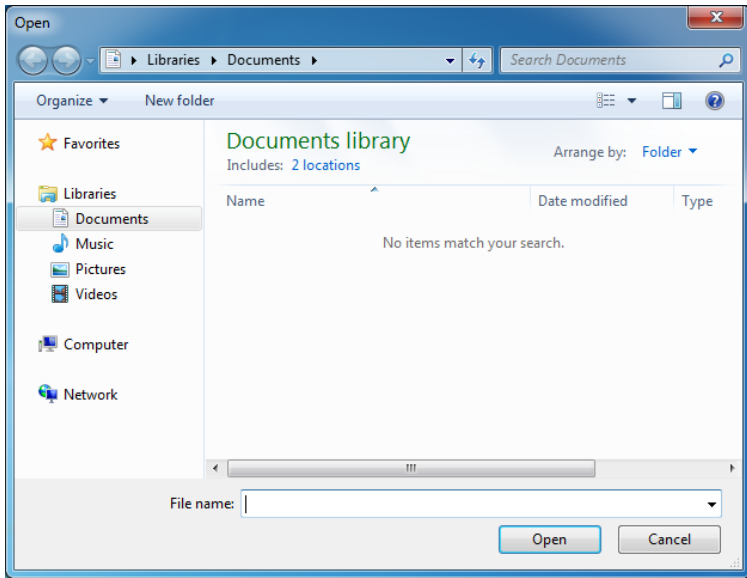

5. A matching program icon will appear in the settings window.

NOTE: You can restore the quick buttons to the default settings by clicking **Get Default**.

Chapter 7

Caring for the Computer

Taking good care of your computer will ensure a trouble-free operation and reduce the risk of damage to your computer.

This chapter gives you guidelines covering areas such as protecting, storing, cleaning, and traveling.

Protecting the Computer

To safeguard the integrity of your computer data as well as the computer itself, you can protect the computer in several ways as described in this section.

Using an Anti-Virus Strategy

You can install a virus-detecting program to monitor potential viruses that could damage your files.

Using the Cable Lock

You can use a Kensington-type cable lock to protect your computer against theft. The cable lock is available in most computer stores.

To use the lock, loop the lock cable around a stationary object such as a table. Insert the lock to the Kensington lock hole and turn the key to secure the lock. Store the key in a safe place.



Taking Care of the Computer

Location Guidelines

- For optimal performance, use the computer where the recommended temperature is between 0 °C (32 °F) and 55 °C (131 °F). (Actual operating temperature depending on product specifications.)
- Avoid placing the computer in a location subject to high humidity, extreme temperatures, mechanical vibration, direct sunlight, or heavy dust. Using the computer in extreme environments for long periods can result in product deterioration and a shortened product life.
- Operating in an environment with metallic dust is not allowed.
- Place the computer on a flat and steady surface. Do not stand the computer on its side or store it in an upside-down position. A strong impact by dropping or hitting may damage the computer.
- Do not cover or block any ventilation openings on the computer. For example, do not place the computer on a bed, sofa, rug, or other similar surface. Otherwise, overheating may occur that results in damage to the computer.
- As the computer can become very hot during operation, keep it away from objects that are vulnerable to heat.
- Keep the computer at least 13 cm (5 inches) away from electrical appliances that can generate a strong magnetic field such as a TV, refrigerator, motor, or a large audio speaker.
- Avoid moving the computer abruptly from a cold to a warm place. A temperature difference of more than 10 °C (18 °F) may cause condensation inside the unit, which may damage the storage media.

General Guidelines

- Do not expose your skin to the computer when operating it in a very hot or cold environment.
- Do not place heavy objects on top of the computer when it is closed as this may damage the display.
- Do not move the computer simply by grasping the display screen.
- The screen surface is easily scratched. Do not use paper towels to clean the display but use the included soft cloth.
- LCD image sticking occurs when a fixed pattern is displayed on the screen for a prolonged period of time. You can avoid the problem by limiting the amount of static content on the display. It is recommended that you use a screen saver or turn off the display when it is not in use.
- To maximize the life of the backlight in the display, allow the backlight to automatically turn off as a result of power management.

Cleaning Guidelines

- Never clean the computer with its power on.
- Use a soft cloth moistened with water or a non-alkaline detergent to wipe the exterior of the computer.
- Gently wipe the display with a soft, lint-free cloth.
- Dust or grease on the touchpad can affect its sensitivity. Clean the pad by using adhesive tape to remove the dust and grease on its surface.
- If water or liquid is split onto the computer, wipe it dry and clean when possible. Though your computer is water-proof, do not leave the computer wet when you can dry it.
- If the computer gets wet where the temperature is 0°C (32°F) or below, freeze damage may occur. Make sure to dry the wet computer.

Battery Pack Guidelines

- Recharge the battery pack when it is nearly discharged. When recharging, make sure that the battery pack is fully charged. Doing so may avoid harm to the battery pack.
- The battery pack is a consumable product and the following conditions will shorten its life:
 - when frequently charging the battery pack
 - when using, charging, or storing in high temperature condition
- To avoid hastening the deterioration of the battery pack thereby prolonging its useful life, minimize the number of times you charge it so as not to frequently increase its internal temperature.
- Charge the battery pack between 10 °C ~ 30 °C (50 °F ~ 86 °F) temperature range. A higher environment temperature will cause the battery pack's temperature to rise. Avoid charging the battery pack inside a closed vehicle and in hot weather condition. Also, charging will not start if the battery pack is not within the allowed temperature range.
- It is recommended that you do not charge the battery pack more than once a day.
- It is recommended that you charge the battery pack with the computer's power off.
- To maintain the battery pack's operating efficiency, store it in a cool dark place removed from the computer and with 30 % ~ 40 % charge remaining.
- Important guidelines when using the battery pack.

When installing or removing the battery pack take note of the following:

 - avoid installing or removing the battery pack when the computer is in Sleep mode. Abruptly removing the battery pack may cause loss of data or the computer may become unstable.
 - avoid touching the battery pack terminals or damage may occur, thereby causing improper operation to it or the computer.

The computer's input voltage and surrounding temperature will directly affect the battery pack's charge and discharge time:

 - charging time will be prolonged when the computer is turned on.

To shorten the charging time, it is recommended that you place the

computer in sleep or hibernation mode.

- a low temperature will prolong the charging time as well as hasten the discharge time.
- When using battery power in an extremely low temperature environment, you may experience shortened operating time and incorrect battery level reading. This phenomenon comes from the chemical characteristics of batteries. The appropriate operating temperature for the battery is $-10\text{ }^{\circ}\text{C}$ $\sim 50\text{ }^{\circ}\text{C}$ ($14\text{ }^{\circ}\text{F}$ $\sim 122\text{ }^{\circ}\text{F}$).
- Do not leave the battery pack in storage for more than six months without recharging it.

Touchscreen Guidelines

- Use the finger or the included stylus on the display. Using a sharp or metallic object other than your finger or stylus may cause scratches and damage the display, thereby causing errors.
- Use a soft cloth to remove dirt on the display. The touchscreen surface has a special protective coating that prevents dirt from sticking to it. Not using a soft cloth may cause damage to the special protective coating on the touchscreen surface.
- Turn off the computer power when cleaning the display. Cleaning the display with the power on may cause improper operation.
- Do not use excessive force on the display. Avoid placing objects on top of the display as this may cause the glass to break thereby damaging the display.
- Using the touchscreen during low temperature (less than $5\text{ }^{\circ}\text{C}$) may cause a slower response time, this is normal. A normal response time may be restored upon returning to room temperature.
- When there is noticeable discrepancy in the operation of the touchscreen function (wrong location on intended operation or improper display resolution), refer to the Windows online Help for instructions on recalibrating the touchscreen display.

When Traveling

- Before traveling with your computer, make a backup of your hard disk data into flash disks or other storage devices. As an added precaution, bring along an extra copy of your important data.
- Make sure that the battery pack is fully charged.
- Make sure that the computer is turned off and the top cover is securely closed.
- Make sure that all the connector covers are closed completely to ensure the waterproof integrity.
- Do not leave objects in between the keyboard and closed display.
- Disconnect the AC adapter from the computer and take it with you. Use the AC adapter as the power source and as a battery-charger.
- Hand-carry the computer. Do not check it in as luggage.
- If you need to leave the computer in the car, put it in the trunk of the car to avoid exposing the computer to excessive heat.
- When going through airport security, it is recommended that you send the computer and flash disks through the X-ray machine (the device you set your bags on). Avoid the magnetic detector (the device you walk through) or the magnetic wand (the handheld device used by security personnel).
- If you plan to travel abroad with your computer, consult your dealer for the appropriate AC power cord for use in your country of destination.

Chapter 8

Troubleshooting

Computer problems can be caused by hardware, software, or both. When you encounter any problem, it might be a typical problem that can easily be solved.

This chapter tells you what actions to take when solving common computer problems.

Preliminary Checklist

Here are helpful hints to follow before you take further actions when you encounter any problem:

- Try to isolate which part of the computer is causing the problem.
- Make sure that you turn on all peripheral devices before turning on the computer.
- If an external device has a problem, make sure that the cable connections are correct and secure.
- Make sure that the configuration information is properly set in the BIOS Setup program.
- Make sure that all the device drivers are correctly installed.
- Make notes of your observations. Are there any messages on the screen? Do any indicators light? Do you hear any beeps? Detailed descriptions are useful to the service personnel when you need to consult one for assistance.

If any problem persists after you follow the instructions in this chapter, contact an authorized dealer for help.

Solving Common Problems

Battery Problems

The battery does not charge (Battery Charge indicator does not light amber).

- Make sure that the AC adapter is properly connected.
- Make sure that the battery is not too hot or cold. Allow time for the battery pack to return to room temperature.
- If the battery doesn't charge after it has been stored in very low temperatures, try disconnecting and reconnecting the AC adapter to solve the problem.
- Make sure that the battery pack is installed correctly.
- Make sure that the battery terminals are clean.

The operating time of a fully charged battery becomes shorter.

- If you often partially recharge and discharge, the battery might not be charged to its full potential. Initialize the battery to solve the problem.

The battery operating time indicated by the battery meter does not match the actual operating time.

- The actual operating time can be different from the estimated time, depending on how you are using the computer. If the actual operating time is much less than the estimated time, initialize the battery.

Bluetooth Problems

I cannot connect to another Bluetooth-enabled device.

- Make sure that both devices have activated Bluetooth feature.
- Make sure that the distance between the two devices is within the limit and that there are no walls or other obstructions between the devices.
- Make sure that the other device is not in "Hidden" mode.

- Make sure that both devices are compatible.

Display Problems

Nothing appears on the screen.

- During operation, the screen may automatically turn off as a result of power management. Press any key to see if the screen comes back.
- The brightness level might be too low. Increase brightness.
- The display output might be set to an external device. To switch the display back to the LCD, press the **Fn+F5** hot key or change the display through the **Display Settings** Properties.

The characters on the screen are dim.

- Adjust the brightness and/or contrast.

The display brightness cannot be increased.

- As a protection, the display brightness will be fixed at a low level when the surrounding temperature is too high or too low. It is not a malfunction in this situation.

Bad dots appear on the display at all times.

- A small number of missing, discolored, or bright dots on the screen are an intrinsic characteristic of TFT LCD technology. It is not regarded as a LCD defect.

DVD Drive Problems

The DVD drive cannot read a disc.

- Make sure that the disc is correctly seated in the tray, with the label facing up.
- Make sure that the disc is not dirty. Clean the disc with a disc cleaning kit, available in most computer stores.
- Make sure that the computer supports the disc or the files contained.

You cannot eject a disc.

- The disc is not properly seated in the drive. Manually release the disc by inserting a small rod, such as a straightened paperclip, into the drive's manual eject hole and pushing firmly to release the tray.



Hardware Device Problems

The computer does not recognize a newly installed device.

- The device may not be correctly configured in the BIOS Setup program. Run the BIOS Setup program to identify the new type.
- Make sure if any device driver needs to be installed. (Refer to the documentation that came with the device.)
- Make sure if the device needs any jumper or switch settings. (Refer to the documentation that came with the device.)
- Check the cables or power cords for correct connections.
- For an external device that has its own power switch, make sure that the power is turned on.

Hard Disk Drive Problems

The hard disk drive error message appears on the screen.

- The hard disk drive has defects. Ask your dealer for help.

The hard disk drive operations seem slow.

- The data files stored on the hard disk drive may be fragmented. Defragment the drive. (See Windows online help for instructions.)

The hard disk drive in-use indicator glows without blinking.

- The data files stored on the hard disk drive may be fragmented. Defragment the drive. (See Windows online help for instructions.)

Keyboard and Touchpad Problems

The keyboard does not respond.

- Try connecting an external keyboard. If it works, contact an authorized dealer, as the internal keyboard cable might be loose.

Water or liquid is spilt into the keyboard.

- Immediately turn off the computer and unplug the AC adapter. Then turn the keyboard upside down to drain the liquid out of the keyboard. Make sure to clean up any part of the spill you can get to. Though the keyboard of your computer is spill-proof, liquid will remain in the keyboard enclosure if you don't remove it. Wait for the keyboard to air dry before using the computer again.

The touchpad does not work, or the pointer is difficult to control with the touchpad.

- Make sure that the touchpad is clean.

LAN Problems

I cannot access the network.

- Make sure that the LAN cable is properly connected to the RJ-45 connector and the network hub.
- Make sure that the network configuration is appropriate.
- Make sure that the user name or password is correct.

Power Management Problems

The computer does not enter Sleep or Hibernation mode automatically.

- If you have a connection to another computer, the computer does not enter Sleep or Hibernation mode if the connection is actively in use.
- Make sure that the Sleep or Hibernation time-out is enabled.

The computer does not enter Sleep or Hibernation mode immediately.

- If the computer is performing an operation, it normally waits for the operation to finish.

The computer does not resume from Sleep or Hibernation mode.

- The computer automatically enters Sleep or Hibernation mode when the battery pack is empty. Do any one of the following:
 - Connect the AC adapter to the computer.
 - Replace the empty battery pack with a fully charged one.

Software Problems

An application program does not work correctly.

- Make sure that the software is correctly installed.
- If an error message appears on the screen, consult the software program's documentation for further information.
- If you are sure the operation has stop, reset the computer. (See "Resetting the Computer" later in this chapter.)

Sound Problems

No sound is produced.

- Make sure that the volume control is not set too low.
- Make sure that the computer is not in Sleep mode.

- If using an external speaker, make sure that the speaker is properly connected.

Distorted sound is produced.

- Make sure that the volume control is not set too high or too low. In most cases, a high setting can cause the audio electronics to distort the sound.

The sound system does not record.

- Adjust the playback or recording sound levels.

Startup Problems

When you turn on the computer, it does not seem to respond.

- Make sure that either the AC adapter is connected or the battery has power.
- **For models with the “HDD preheat” feature:** When turning on the computer in an extremely low temperature environment, the computer will heat up the hard disk before starting up. The Num Lock indicator glows amber to indicate the heater is on. Wait till the heating is finished. However, if external AC power is not available and the remaining battery power is too low for the heating to complete, the computer may not start up. In case the computer fails to start up, turn off the computer and leave it in room temperature for about an hour before trying to turn it on again.

When you turn on the computer, it stops after POST.

- Restart your computer.

WLAN Problems

I cannot use the WLAN feature.

- Make sure that the WLAN feature is turned on.

Transmission quality is poor.

- Your computer may be in an out-of-range situation. Move your computer closer to the Access Point or another WLAN device it is associated with.
- Check if there is high interference around the environment and solve the problem as described next.

Radio interference exists.

- Move your computer away from the device causing the radio interference such as microwave oven and large metal objects.
- Plug your computer into an outlet on a different branch circuit from that used by the affecting device.
- Consult your dealer or an experienced radio technician for help.

I cannot connect to another WLAN device.

- Make sure that the WLAN feature is turned on.
- Make sure that the SSID setting is the same for every WLAN device in the network.
- Your computer is not recognizing changes. Restart the computer.
- Make sure that the IP address or subnet mask setting is correct.

I cannot communicate with the computer in the network when Infrastructure mode is configured.

- Make sure that the Access Point your computer is associated with is powered on and all the LEDs are working properly.
- If the operating radio channel is in poor quality, change the Access Point and all the wireless station(s) within the BSSID to another radio channel.
- Your computer may be in an out-of-range situation. Move your computer closer to the Access Point it is associated with.
- Make sure that your computer is configured with the same security option (encryption) to the Access Point.

- Use the Web Manager/Telnet of the Access Point to check whether it is connected to the network.
- Reconfigure and reset the Access Point.

I cannot access the network.

- Make sure that the network configuration is appropriate.
- Make sure that the user name or password is correct.
- You have moved out of range of the network.
- Turn off power management.

Other Problems

The date/time is incorrect.

- Correct the date and time via the operating system or BIOS Setup program.
- After you have performed everything as described above and still have the incorrect date and time every time you turn on the computer, the RTC (Real-Time Clock) battery is at the end of its life. Call an authorized dealer to replace the RTC battery.

Resetting the Computer

You may have to reset (reboot) your computer on some occasions when an error occurs and the program you are using hangs up.

If you are sure the operation has stopped and you cannot use the “restart” function of the operating system, reset the computer

Reset the computer by any of these methods:

- Press **Ctrl+Alt+Del** on the keyboard. This opens the **Ctrl-Alt-Del** screen where you can select actions including **Restart**.
- If the above action does not work, press and hold the power button for more than 5 seconds to force the system to turn off. Then turn on the power again.

System Recovery

System Restore, Refresh, or Reset (for Windows 8 Models)

If you're having problems with your Windows 8 computer, you can try to restore, refresh, or reset it.

To restore your computer to an earlier point in time:

1. Enter **Recovery** in the search box.
2. Click **Settings**, and then click **Recovery**.
3. Click **Open System Restore**.

To refresh your computer without affecting your files:

1. Open the Charms Bar of Windows.
2. Click **Settings** → **Change PC Settings** → **Update and recovery** → **Recovery**.
3. Under **Refresh your PC without affecting your files**, click **Get started**.

To remove everything and reinstall Windows:

1. Open the Charms Bar of Windows.
2. Click **Settings** → **Change PC Settings** → **Update and recovery** → **Recovery**.
3. Under **Remove everything and reinstall Windows**, click **Get started**.

System Recovery (a Tool for Windows 7 Models)

Use System Recovery when:

- The Windows 7 operating system does not start at all.
- You want to restore the system to the factory state.

WARNING:

- Using this feature will reinstall Windows to your system and configure it to the system's factory default settings. All data on the hard disk drive will be lost.
- Make sure that power is not interrupted during the recovery process. An unsuccessful recovery may result in Windows startup problems.

To run System Recovery:

1. Connect the AC adapter.
2. Turn on the computer. During system startup when the following screen appears, press **Ctrl + Alt + F2** keys for four second.

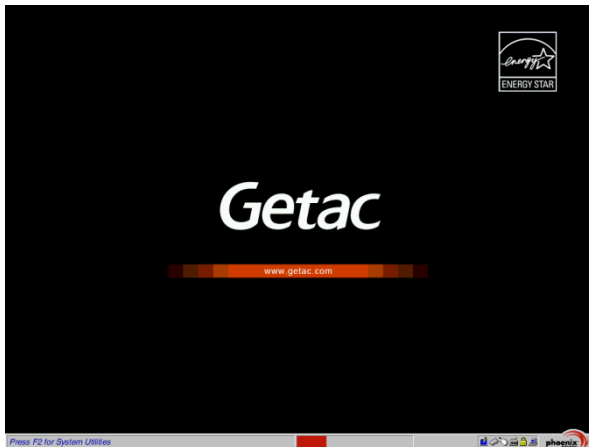

3. In the screen that appears, select **Recovery** to start the recovery process.



4. The progress bar shows the percentage completed. When it reaches 100%, the system turns off.
5. Turn on the computer. The Windows setup wizard starts. Follow the onscreen prompts to continue.
6. When the system restarts, the installer screen appears. The installer will perform system hardware detection and driver installation.

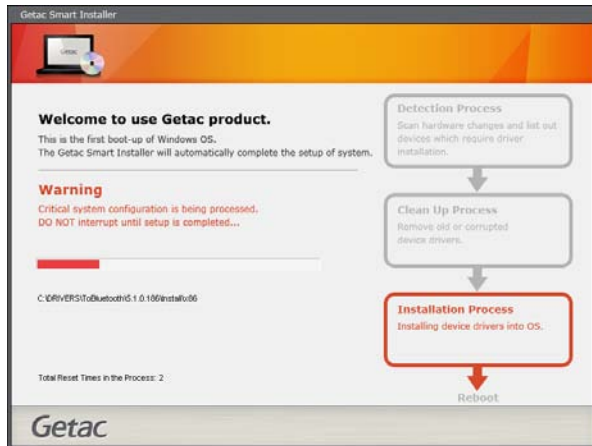

7. When completed, the system restarts and displays Windows desktop.

Appendix A

Specifications

NOTE: Specifications are subject to change without any prior notice.

Parts		Specifications
CPU		Intel® Core™ i5-4300M vPro™ Processor 2.6GHz, Max. 3.3GHz with Intel® Turbo Boost Technology, 3MB L3 Intel® Smart Cache
		Intel® Core™ i7-4600M vPro™ Processor 2.9GHz, Max 3.6GHz, with Intel® Turbo Boost Technology, 4MB L3 Intel® Smart Cache
Chipset		Intel® QM87
BIOS		UEFI, supporting ACPI, Fingerprint security, SmartCard security, TPM, vPro, Asset Tag, and NIST
RAM (system)		2 × 204-pin SO-DIMM sockets for 4GB/8GB DDR3L, 1600MHz
Display	Panel	13.3-inch (4:3) TFT LCD, resolution up to 1024×768 XGA, with light sensor as default feature Can come with one of the below options: – Sunlight-readable (1400 nits) touchscreen – Sunlight-readable (700 nits) screen with protection glass
	Video controller	Intel® HD Graphics 4600
Audio	Features	Azalia interface, 2 channel analog output, internal microphone
	Speaker	1.5 watt (8 ohm) stereo × 2
	Microphone	Integrated microphone
Keyboard		Standard keys with numeric pad keys, 12 function keys, special Fn (Function) key and Windows keys, with backlight (option)
Pointing device		Glide touchpad with 2 buttons, scroll bar
Storage device	Hard disk drive	SATA III interface, 500GB, 128GB /256GB SSD (solid-state disk) (option)
	DVD drive	SATA interface, Super-Multi DVD drive

Parts		Specifications
Card slots		SecureDigital card PCMCIA CardBus Type II ExpressCard/54 Smart Card
I/O ports		USB 3.0, eSATA/ USB 3.0 combo x 2, serial (RS-232) x 2, VGA, HDMI, RJ-45, headphone out, microphone, mini IEEE 1394a , docking (80 pin)
LAN		Intel® Clarkville-LM Gigabit Network Connection, 10/100/1000 Mbps, supporting Intel® AMT 9.0 (vPro™ brand)
Wireless LAN and Bluetooth		Intel (Wilkins Peak 2) 802.11 AC + Bluetooth combo (7260 AC), compliant with IEEE 802.11a/b/g/n/ac, Bluetooth 4.0 + EDR Class 1
GPS (option)		GPS module, GPS pass-through
WWAN (option)		WCDMA/HSDPA/LTE, external accessible SIM card slot, WWAN pass-through
Security		Kensington lock TPM 1.2 Fingerprint scanner Smart Card Reader
Power	AC adapter	Universal AC adapter 90 W; input: 100~240 V, output: 19 V
	Battery	Li-ion smart battery 9-cell 8700 mAH / 10.8 V
Dimension (WxD)		303.5×298×60 mm (11.9×11.7×2.36 inch) with handle
Weight		3.5 kg (7.7 lb)

Appendix B

Regulatory Information

This appendix provides regulatory statements and safety notices on your computer.

NOTE: Marking labels located on the exterior of your computer indicate the regulations that your model complies with. Please check the marking labels and refer to the corresponding statements in this appendix. Some notices apply to specific models only.

On the Use of the System

Class B Regulations

USA

Federal Communications Commission Radio Frequency Interference Statement

NOTE:

This equipment has been tested and found to comply with the limits for a Class B digital device pursuant to Part 15 of the FCC Rules. These limits are designed to provide reasonable protection against harmful interference in a residential installation. This equipment generates, uses, and can radiate radio frequency energy and, if not installed and used in accordance with the instructions, may cause harmful interference to radio communications. However, there is no guarantee that interference will not occur in a particular installation. If this equipment does cause harmful interference to radio or television reception, which can be determined by turning the equipment off and on, the user is encouraged to try to correct the interference by one or more of the following measures:

- Reorient or relocate the receiving antenna.
- Increase the separation between the equipment and receiver.
- Connect the equipment into an outlet on a circuit different from that to which the receiver is connected.
- Consult the dealer or an experienced radio/TV technician for help.

Any changes or modifications not expressly approved by the manufacturer could void the user's authority to operate the equipment.

Please note:

The use of a non-shielded interface cable with this equipment is prohibited.

Canada

Canadian Department of Communications Radio Interference Regulations Class B Compliance Notice

This Class B digital apparatus meets all requirements of the Canada Interference-Causing equipment regulations.

Cet appareil numérique de Classe B respecte toutes les exigences du Règlement Canadien sur le matériel brouilleur.

This digital apparatus does not exceed the Class B limits for radio noise emissions from digital apparatus set out in the Radio Interference Regulations of the Canadian Department of Communications.

Le présent appareil numérique n'émet pas de bruits radioélectriques dépassant les limites applicables aux appareils numériques de la classe B prescrites dans le Règlement sur le brouillage radioélectrique édicté par le ministère des Communications du Canada.

ANSI Warning

Equipment approved for ANSI/ISA 12.12.01, Nonincendive Electrical Equipment for use in Class 1, Division 2, Group A, B, C, and D.

Maximum ambient temperature: -25°C~55°C; Temperature code: T5

- **WARNING:** To prevent ignition of a hazardous atmosphere, batteries must only be changed or charged in an area known to be non-hazardous.
- **EXPLOSION HAZARD WARNING:** External connections/hubs through the connectors as mentioned (USB connector, Ethernet connector, phone connector, video port, serial port, power supply connector, microphone jack, headphones jack, and buttons/switches) and super multi DVD/combo drive are not to be used in a hazardous location.
- Power adapter shall not be used in hazardous locations.

Safety Notices

About the Battery

Caution Texts Concerning Lithium Batteries

DANISH

ADVARSEL! Lithiumbatteri – Eksplosionsfare ved fejlagtig håndtering. Udskiftning må kun ske med batteri af samme fabrikat og type. Levér det brugte batteri tilbage til leverandøren.

NORWEGIAN

ADVARSEL: Eksplosjonsfare ved feilaktig skifte av batteri. Benytt samme batteritype eller en tilsvarende type anbefalt av apparatfabrikanten. Brukte batterier kasseres i henhold til fabrikantens instruksjoner.

SWEDISH

VARNING: Explosionsfara vid felaktigt batteribyte. Använd samma batterityp eller en ekvivalent typ som rekommenderas av apparattillverkaren. Kassera använt batteri enligt fabrikantens instruktion.

FINNISH

VAROITUS: Paristo voi räjähtää, jos se on virheellisesti asennettu. Vaihda paristo ainoastaan valmistajan suosittellemaan tyyppiin. Hävitä käytetty paristo valmistajan ohjeiden mukaisesti.

ENGLISH

CAUTION: Danger of explosion if battery is incorrectly replaced. Replace only with the same or equivalent type recommended by the equipment manufacturer. Discard used batteries according to manufacturer's instructions.

DEUTSCH

VORSICHT: Explosionsgefahr bei unsachgemäßem Austausch der Batterie. Ersatz nur durch denselben oder einen vom Hersteller empfohlenen gleichwertigen Typ. Entsorgung gebrauchter Batterien nach Angaben des Herstellers.

FRENCH

ATTENTION: Il y a danger d'explosion s'il y a remplacement incorrect de la batterie. Remplacer uniquement avec une batterie du même type ou d'un

type équivalent recommandé par le constructeur. Mettre au rebut les batteries usagées conformément aux instructions du fabricant.

Attention (for USA Users)

The product that you have purchased contains a rechargeable battery. The battery is recyclable. At the end of its useful life, under various state and local laws, it may be illegal to dispose of this battery into the municipal waste stream. Check with your local solid waste officials for details in your area for recycling options or proper disposal.

About the AC Adapter

- Use only the AC adapter supplied with your computer. Use of another type of AC adapter will result in malfunction and/or danger.
- Do not use the adapter in a high moisture environment. Never touch the adapter when your hands or feet are wet.
- Allow adequate ventilation around the adapter when using it to operate the device or charge the battery. Do not cover the AC adapter with paper or other objects that will reduce cooling. Do not use the AC adapter while it is inside a carrying case.
- Connect the adapter to a proper power source. The voltage requirements are found on the product case and/or packaging.
- Do not use the adapter if the cord becomes damaged.
- Do not attempt to service the unit. There are no serviceable parts inside. Replace the unit if it is damaged or exposed to excess moisture.

On the Use of the RF Device

USA and Canada Safety Requirements and Notices

IMPORTANT NOTE: To comply with FCC RF exposure compliance requirements, the antenna used for this transmitter must be installed to provide a separation distance of at least 20 cm from all persons and must not be co-located or operating in conjunction with any other antenna or transmitter.

Radio Frequency Interference Requirements and SAR

This device meets the government's requirements for exposure to radio waves.

This device is designed and manufactured not to exceed the emission limits for exposure to radio frequency (RF) energy set by the Federal Communications Commission of the U.S. Government.

This device complies with FCC radiation exposure limits set forth for an uncontrolled environment.

EMC Requirements

This device uses, generates and radiates radio frequency energy. The radio frequency energy produced by this device is well below the maximum exposure allowed by the Federal Communications Commission (FCC).

This device complies with the limits for a Class B digital device pursuant to Part 15 subpart C of the FCC Rules and Regulations. Operation is subject to the following two conditions:

- (1) This device may not cause harmful interference.
- (2) This device must accept any interference received, including interference that may cause undesired operation.

The FCC limits are designed to provide reasonable protection against harmful interference when the equipment is installed and used in accordance with the instruction manual and operated in a commercial environment. However, there is no guarantee that interference will not

occur in a particular commercial installation, or if operated in a residential area.

If harmful interference with radio or television reception occurs when the device is turned on, the user must correct the situation at the user's own expense. The user is encouraged to try one or more of the following corrective measures:

- Reorient or relocate the receiving antenna.
- Increase the separation between the equipment and receiver.
- Connect the equipment into an outlet on a circuit different from that to which the receiver is connected.
- Consult the dealer or an experienced radio/TV technician for help.

CAUTION: The Part 15 radio device operates on a non-interference basis with other devices operating at this frequency. Any changes or modification to said product not expressly approved by the manufacturer could void the user's authority to operate this device.

Canada Radio Frequency Interference Requirements

To prevent radio interference to the licensed service, this device is intended to be operated indoors and away from windows to provide maximum shielding. Equipment (or its transmit antenna) that is installed outdoors is subject to licensing.

Pour empêcher que cet appareil cause du brouillage au service faisant l'objet d'une licence, il doit être utilisé à l'intérieur et devrait être placé loin des fenêtres afin de fournir un écran de blindage maximal. Si le matériel (ou son antenne d'émission) est installé à l'extérieur, il doit faire l'objet d'une licence.

European Union CE Marking and Compliance Notices

Statements of Compliance

English

This product follows the provisions of the European Directive 1999/5/EC.

Danish

Dette produkt er i overensstemmelse med det europæiske direktiv 1999/5/EC.

Dutch

Dit product is in navolging van de bepalingen van Europees Directief 1999/5/EC.

Finnish

Tämä tuote noudattaa EU-direktiivin 1999/5/EC määräyksiä.

French

Ce produit est conforme aux exigences de la Directive Européenne 1999/5/EC.

German

Dieses Produkt entspricht den Bestimmungen der Europäischen Richtlinie 1999/5/EC.

Greek

Το προϊόν αυτό πληροί τις προβλέψεις της Ευρωπαϊκής Οδηγίας 1999/5/EC.

Icelandic

Þessi vara stenst reglugerð Evrópska Efnahags Bandalagsins númer 1999/5/EC.

Italian

Questo prodotto è conforme alla Direttiva Europea 1999/5/EC.

Norwegian

Dette produktet er i henhold til bestemmelsene i det europeiske direktivet 1999/5/EC.

Portuguese

Este produto cumpre com as normas da Diretiva Européia 1999/5/EC.

Spanish

Este producto cumple con las normas del Directivo Europeo 1999/5/EC.

Swedish

Denna produkt har tillverkats i enlighet med EG-direktiv 1999/5/EC.

Restrictions

This device is restricted to indoor use when operating in the 5150 to 5350 MHz frequency range.

User Notification of Take-back Service

To Institutional (B2B) Users in United States:

Getac believes in providing our institutional customers with easy-to-use solutions to recycle your Getac-brand products for free. Getac understands the institutional customers will likely be recycling multiple items at once and as such. Getac wants to make the recycling process for these larger shipments as streamlined as possible. Getac works with recycling vendors with the highest standards for protecting our environment, ensuring worker safety, and complying with global environmental laws. Our commitment to recycling our old equipment grows out of our work to protect the environment in many ways.

Please see the product type below for information on Getac product, battery and packaging recycling in USA.

- **For Product Recycling:**
Your portable Getac products contain hazardous materials. While they pose no risk to you during normal use, they should never be disposed with other wastes. Getac provides a free take-back service for recycling your Getac products. Our electronics recycler will provide competitive bids for recycling non-Getac products as well.
- **For Battery Recycling:**
The batteries used to power your portable Getac products contain hazardous materials. While they pose no risk to you during normal use, they should never be disposed with other wastes. Getac provides a free take-back service for recycling your batteries from Getac products.
- **For Packaging Recycling:**
Getac has chosen the packaging materials used to transport our products carefully, to balance the requirements of shipping the product to you safely while minimizing the amount of material used. The materials used in our packaging are designed to be recycled locally.

If you have the above for recycling, please contact our recycler, All Green Electronics Recycling, LLC. For more information on recycling, visit the website <http://www.allgreenrecycling.com>.

ENERGY STAR



ENERGY STAR® is a government program that offers businesses and consumers energy-efficient solutions, making it easy to save money while protecting the environment for future generations.

Please reference ENERGY STAR® related information from <http://www.energystar.gov>.

As an ENERGY STAR® Partner, Getac Technology Corporation has determined that this product meets the ENERGY STAR® guidelines for energy efficiency.

An ENERGY STAR® qualified computer uses 70 % less electricity than computers without enabled power management features.

Earning the ENERGY STAR®

- When every home office is powered by equipment that has earned the ENERGY STAR®, the change will keep over 289 billion pounds of greenhouse gases out of the air.
- If left inactive, ENERGY STAR® qualified computers enter a low-power mode and may use 15 watts or less. New chip technologies make power management features more reliable, dependable, and user-friendly than even just a few years ago.
- Spending a large portion of time in low-power mode not only saves energy, but helps equipment run cooler and last longer.
- Businesses that use ENERGY STAR® enabled office equipment may realize additional savings on air conditioning and maintenance.

- Over its lifetime, ENERGY STAR® qualified equipment in a single home office (e.g., computer, monitor, printer, and fax) can save enough electricity to light an entire home for more than 4 years.
- Power management (“sleep settings”) on computers and monitors can result in much savings annually.

Remember, saving energy prevents pollution

Because most computer equipment is left on 24 hours a day, power management features are important for saving energy and are an easy way to reduce air pollution. By using less energy, these products help lower consumers’ utility bills, and prevent greenhouse gas emissions.

Getac Product Compliance

All Getac products with ENERGY STAR® logo comply with the ENERGY STAR® standard, and the power management feature is enabled by default. The monitor and computer are automatically set to sleep after 15 and 30 minutes of user inactivity. To wake your computer, click the mouse or press any key on the keyboard. Please visit <http://www.energystar.gov/powermanagement> for detail information on power management and its benefits to the environment.

Battery Recycling

For the U.S. and Canada only:

To recycle the battery, please go to the RBRC Call2Recycle website or use the Call2Recycle Helpline at 800-822-8837.

Call2Recycle® is a product stewardship program providing no-cost battery and cellphone recycling solutions across the U.S. and Canada. Operated by Call2Recycle, Inc., a 501(c)4 nonprofit public service organization, the program is funded by battery and product manufacturers committed to responsible recycling. See more at: <http://www.call2recycle.org>

