

# **SPME Fiber Conditioning Station for Agilent GC Injector**

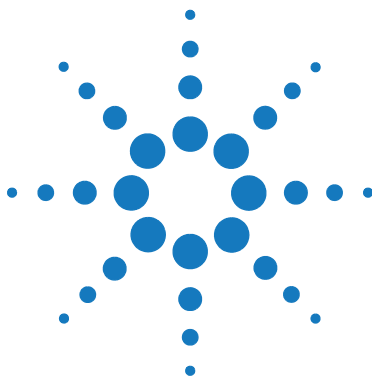

## **User Manual**



**Agilent Technologies**

# Notices

© Agilent Technologies, Inc. 2010

No part of this manual may be reproduced in any form or by any means (including electronic storage and retrieval or translation into a foreign language) without prior agreement and written consent from Agilent Technologies, Inc. as governed by United States and international copyright laws.

## Manual Part Number

G6504-90000

## Edition

08/2010

Printed in Germany

Agilent Technologies  
Hewlett-Packard-Strasse 8  
76337 Waldbronn

**This product may be used as a component of an in vitro diagnostic system if the system is registered with the appropriate authorities and complies with the relevant regulations. Otherwise, it is intended only for general laboratory use.**

## Warranty

**The material contained in this document is provided “as is,” and is subject to being changed, without notice, in future editions. Further, to the maximum extent permitted by applicable law, Agilent disclaims all warranties, either express or implied, with regard to this manual and any information contained herein, including but not limited to the implied warranties of merchantability and fitness for a particular purpose. Agilent shall not be liable for errors or for incidental or consequential damages in connection with the furnishing, use, or performance of this document or of any information contained herein. Should Agilent and the user have a separate written agreement with warranty terms covering the material in this document that conflict with these terms, the warranty terms in the separate agreement shall control.**

## Technology Licenses

The hardware and/or software described in this document are furnished under a license and may be used or copied only in accordance with the terms of such license.

## Restricted Rights Legend

If software is for use in the performance of a U.S. Government prime contract or subcontract, Software is delivered and licensed as “Commercial computer software” as defined in DFAR 252.227-7014 (June 1995), or as a “commercial item” as defined in FAR 2.101(a) or as “Restricted computer software” as defined in FAR 52.227-19 (June 1987) or any equivalent agency regulation or contract clause. Use, duplication or disclosure of Software is subject to Agilent Technologies’ standard commercial license terms, and non-DOD Departments and Agencies of the U.S. Government will

receive no greater than Restricted Rights as defined in FAR 52.227-19(c)(1-2) (June 1987). U.S. Government users will receive no greater than Limited Rights as defined in FAR 52.227-14 (June 1987) or DFAR 252.227-7015 (b)(2) (November 1995), as applicable in any technical data.

## Safety Notices

### CAUTION

A **CAUTION** notice denotes a hazard. It calls attention to an operating procedure, practice, or the like that, if not correctly performed or adhered to, could result in damage to the product or loss of important data. Do not proceed beyond a **CAUTION** notice until the indicated conditions are fully understood and met.

### WARNING

A **WARNING** notice denotes a hazard. It calls attention to an operating procedure, practice, or the like that, if not correctly performed or adhered to, could result in personal injury or death. Do not proceed beyond a **WARNING** notice until the indicated conditions are fully understood and met.

# Contents

<b>1</b>	<b>General Information</b>	<b>5</b>
	Safety Information	6
	How to Use this Manual	13
<b>2</b>	<b>Installation of PAL SPME Fiber Conditioning Station</b>	<b>15</b>
	General System Overview	16
	Installation	18
	PAL Firmware and PAL Object Installation for PAL SPME Fiber Conditioning Station Option	22
<b>3</b>	<b>PAL SPME Fiber Conditioning Station Operation</b>	<b>29</b>
	Operation and Temperature Setting	30
<b>4</b>	<b>Appendices</b>	<b>33</b>
	Definition of Terms	34
	Naming Convention	37
	Spare Parts	38

## Contents



# 1 General Information

Safety Information 6

How to Use this Manual 13



## Safety Information



### **General Considerations**

The SPME Upgrade System User Manual and the corresponding “Addendum” for a specific module must be consulted by the user under all circumstances before a unit is put in use.

Changes or modifications to this unit not expressly approved by the party responsible for compliance could void the user’s authority to operate the equipment.

The user shall be made aware that if the equipment is used in a manner not specified by the manufacturer, the protection provided by the equipment may be impaired.

When using the SPME Upgrade System, follow the generally accepted procedures for quality control and methods development.

When you use the SPME Upgrade System in the field of chromatographic analysis and you observe a change in the retention of a particular compound, in the resolution between two compounds, or in peak shape, immediately determine the reason for the changes. Until you determine the cause of a change, do not rely on the separation results.

**Electrical Hazards**

Every analytical instrument has specific hazards, so be sure to read and comply with the following precautions. They will help ensure the safe, long-term use of your SPME Upgrade System.

The Installation Category (Over voltage Category) for this instrument is Level II. The Level II Category pertains to equipment that receives its electrical power from the local level, such as an electrical wall outlet.

Only use fuses of the type and current rating specified. Do not use repaired fuses and do not short-circuit the fuse holder.



The supplied power cord must be inserted into a power outlet with a protective earth contact (ground). When using an extension cord, make sure that the cord also has an earth contact.



Do not change the external or internal grounding connections. Tampering with or disconnecting these connections could endanger you and/or damage the SPME Upgrade System.

The instrument is properly grounded in accordance with these regulations when shipped. You do not need to make any changes to the electrical connections or the instrument's chassis to ensure safe operation.



The combination of a SPME Upgrade System with a LC/MS System does require the safety measure as described by the LC/MS System manufacturer. Detailed instructions for the safety grounding on the LC/MS system are outlined in the corresponding operating/installation manual.

Agilent Technologies recommends to use a grounding cable connected on one side at the Injection Valve, Loop or any other suitable direct metallic contact and the other side at an appropriate grounding point at the LC/MS System. This supplementary grounding measure will support the safety strategy of the LC/MS System manufacturer.



Do not turn the instrument on if you suspect that it has incurred any kind of electrical damage. Instead disconnect the power cord and contact a Agilent Technologies representative for a product evaluation. Do not attempt to use the instrument until it has been evaluated. Electrical damage may have occurred if the SPME Upgrade System shows visible signs of damage, exposure to any liquids or has been transported under severe stress.

Damage can also result if the instrument is stored for prolonged periods under unfavorable conditions (e.g. subjected to heat, water, etc.).



In any case disconnect the power cord(s) from the power supply or from the different power supplies if optional devices are installed before attempting any type of maintenance.

Capacitors inside the instrument may still be charged even if the instrument is turned off.



To avoid damaging electrical parts, do not disconnect an electrical assembly while power is applied to the SPME Upgrade system. Once the power is turned off, wait approximately 30 seconds before you disconnect an assembly.

The instrument includes a number of integrated circuits. These circuits may be damaged if exposed to excessive line voltage fluctuations and/or power surges.



Never try to repair or replace any components of the instrument that is not described in this manual without the assistance of a Agilent Technologies representative.

There are no operator-serviceable or replaceable parts inside the power supply(ies) or in the SPME Upgrade System. If a power supply is not functioning, contact a Agilent Technologies representative.





The power supply for the SPME Upgrade Instrument has the symbols 1/0 on the label for the power switch to switch ON/OFF.

Any additional power supply for other devices like, Cooled Stack or a Valve Module shows the symbols as shown below on the label for the power switch:



The symbols shall warn the user that in a emergency case more than one power supply has to be turned OFF or more than one power cord has to be pulled from power supply or from the wall outlet to shut down the complete SPME Upgrade System.

If the basic SPME Upgrade System is installed, than a single power supply is installed only. Turning OFF the power supply or pulling this single power cord in an emergency case will stop the complete SPME Upgrade System.

It is important that the power supply (ies) are in a location where the power ON and OFF switch is accessible and easy to operate, and where it is possible to unplug the AC power cord from the power supply/wall outlet in case of emergency.

## 1 General Information

### Safety Information

#### Other Hazards



To avoid injury during SPME Upgrade System operation, keep your hands away from the syringe.



Do not operate the SPME Upgrade System without the safety shield. The safety shield must be installed for safe operation.



To avoid injury, observe safe laboratory practice when you handle solvents, change tubing, or operate the SPME Upgrade System. Know the physical and chemical properties of the solvents you use. See the Material Safety Sheets from the manufacturer for the solvents in use.



Use caution when working with any polymer tubing under pressure:

- Always wear eye protection when near pressurized polymer tubing.
- Do not use polymer tubing that has been severely stressed or kinked.
- Do not use polymer tubing, in particular not PEEK or Tefzel tubing, with Tetrahydrofuran (THF), Dimethylsulfoxid (DMSO), chlorinated organic solvents, concentrated mineral acids, such as Nitric, Phosphoric or Sulfuric acids, or any related compounds to above listings.



Do not use vials without a sealing cap, microtiter or deepwell plates without a plate seal. Vapor phase from organic solvents can be hazardous and flammable. Acidic vapor phase can cause corrosion to critical mechanical parts.

**Disposal**



Do not dispose of this equipment or parts thereof unsorted in municipal waste. Follow local municipal waste ordinances for proper disposal provisions to reduce the environmental impact of waste electrical and electronic equipment (WEEE). European Union customers: Call your local customer service representative responsible for the PAL System for complimentary equipment pick-up and recycling.

**Lithium battery**



An onboard lithium battery buffers the electronic memories, when the instrument is turned off. Replace it only with the same or equivalent type recommended by the equipment manufacturer.











Battery: Panasonic VL 2330, soldered directly on the electronic board. Discharged lithium batteries shall be disposed off locally according to national waste disposal regulations for batteries.

There are no operator-serviceable parts on the electronic boards. If an electronic board fails, contact a Agilent Technologies representative.

# 1 General Information

## Safety Information

**Table 1** Commonly Used Symbols

Symbol	Description
	Caution or refer to User Manual
	Caution, Risk of Needle-Stick Puncture
	Caution, Hot Surface or High Temperature
	Direct Current
	Alternating Current
	Protective Conductor Terminal, Ground
	Fuse
I	Electrical Power ON. Used with Main SPME Upgrade Power Supply.
0	Electrical Power OFF. Used with Main SPME Upgrade Power Supply.
	Electrical Power ON for Only Part of the System. Used with Optional Device(s)
	Electrical Power OFF for Only Part of the System. Used with Optional Device(s)
	Caution, Risk of Electrical shock (high voltage)
	Disposal, Do not dispose in municipal waste. Follow local waste regulations to reduce electrical and electronic waste (WEEE).

## How to Use this Manual

The major sections of this Addendum are:

- Safety Information
- SPME Fiber Conditioning Station Installation
- SPME Fiber Conditioning Station Operation
- Appendices

This Addendum is intended for frequent or new PAL System users who are experienced at using automated systems to run existing analytical methods.

The Appendices provide information on PAL SPME Fiber Conditioning Station and Spare Parts.

### NOTE

The Agilent GC Sampler 80/120 must be installed and set up properly before the SPME Fiber Conditioning Station Operating instructions can be used.

---

**1** **General Information**  
How to Use this Manual



## 2 Installation of PAL SPME Fiber Conditioning Station

General System Overview	16
Specifications	17
PAL Hardware Requirements	17
Software Requirements	17
Installation	18
Unpacking the Components	18
Assembling the SPME Fiber Conditioning Station	19
Electrical Connections	20
Gas-Line Connections	21
PAL Firmware and PAL Object Installation for PAL SPME Fiber Conditioning Station Option	22
PAL Firmware Installation for SPME Fiber Conditioning Station	22
PAL Firmware Object List Installation for the SPME Fiber Conditioning Station	23
Cycle Composer Control	26
Installation of Macros for Cycle Composer	27



## General System Overview

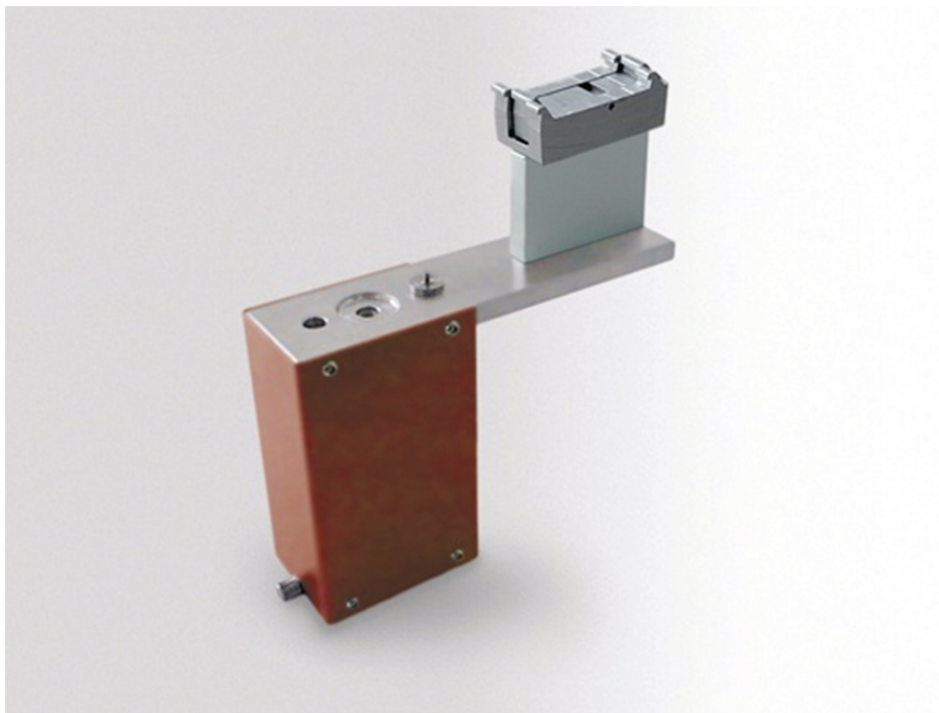

**Figure 1** SPME Fiber Conditioning Station

The SPME Fiber Conditioning Station is an optional device used for the SPME technique (Solid Phase Micro Extraction).

The purpose is to clean or condition a fiber between chromatographic runs. A flow of inert gas protects the fiber from degradation if exposed to elevated temperatures. The temperature for conditioning or cleaning is selectable.

A spare fiber can be conditioned in the front well to ensure a spare fiber is always ready for use.



## Specifications

<b>Table 2</b>	Specifications
Article Number:	PAL FibCond
Description:	SPME Fiber Conditioning Station
Temperature Control:	30 °C to 350 °C in steps of 1 °C
Dimensions:	L: 50 mm D: 175 mm H: 170 mm Std. bracket holder H: 144 mm Short bracket holder
Weight:	820 g

## PAL Hardware Requirements

The SPME Fiber Conditioning Station can be used with any PAL System. A gas supply has to be provided. Consequently, a PAL System equipped for headspace or SPME technique would be a logical choice. The electrical heating is provided via an “Aux” interface, typically “AUX2”.

## Software Requirements

The heating for the SPME Fiber Conditioning Station is controlled directly by the PAL System. Temperature control via software, such as Cycle Composer or certain data handling systems that control the PAL using Cycle Editor for PAL ICC interpretation, is not possible.

The SPME Fiber Conditioning Station is compatible with PAL Firmware level 2.0X or higher. However the minimum firmware level for the SPME technique should be 2.2.7.or higher.

## Installation

### Unpacking the Components

The SPME Fiber Conditioning Station is shipped in one box. Check for the following items:

- SPME Fiber Conditioning Station
- PAL SPME Fiber Conditioning Station:
  - Gas tube, Teflon, black
  - Swagelok Union 1/8 inch (includes flow reduction)
  - Reducing Unit M5
- PAL Zub-SPME:
  - Short Bracket (14 mm) with 2 screws and 2 serrated washers
- Disk: PAL Object Manager Software:
  - Software to add new Objects to the Agilent GC Sampler 80/120

## Assembling the SPME Fiber Conditioning Station

Before beginning the assembly process, determine approximately where the SPME Fiber Conditioning Station will be located. Consider the height of the station in order to be able to move a 20 ml vial across from the Tray to the Agitator and visa versa.

If there is not enough space between the X-axis of the Agilent GC Sampler 80/120 and the GC top cover, consider installing the short bracket, which is part of the installation kit.

If the SPME Fiber Conditioning Station is to be installed with an existing Agilent GC Sampler 80/120 System, another hardware module may need to be shifted. Remember to re-position the modules again according the Agilent GC Sampler 80/120 manual.

- 1 Loosen the Torx screw on the mounting clamps located on the top side of the Conditioning Station.
- 2 Be sure that the clamps fit entirely into the grooves. Tighten the Torx screw until the mounting clamps are firmly in place.
- 3 Double check whether the SPME Fiber Conditioning Station clamp is correctly attached to the X-crossrail (see Agilent GC Sampler 80/120 manual).

### NOTE

The short bracket that is provided is a spacer 14 mm high which could be installed instead of the standard bracket in cases where the total height of the fiber conditioning station does not physically fit the System.

## Electrical Connections

Installing the SPME Fiber Conditioning Station

**NOTE**

It is important to power off the Agilent GC Sampler 80/120 System before the SPME Fiber Conditioning Station is electrically connected.

- 1 Connect the open end of the cable from the SPME Fiber Conditioning Station to the “AUX2” connector on the Agilent GC Sampler 80/120. See [Figure 2](#) on page 20.

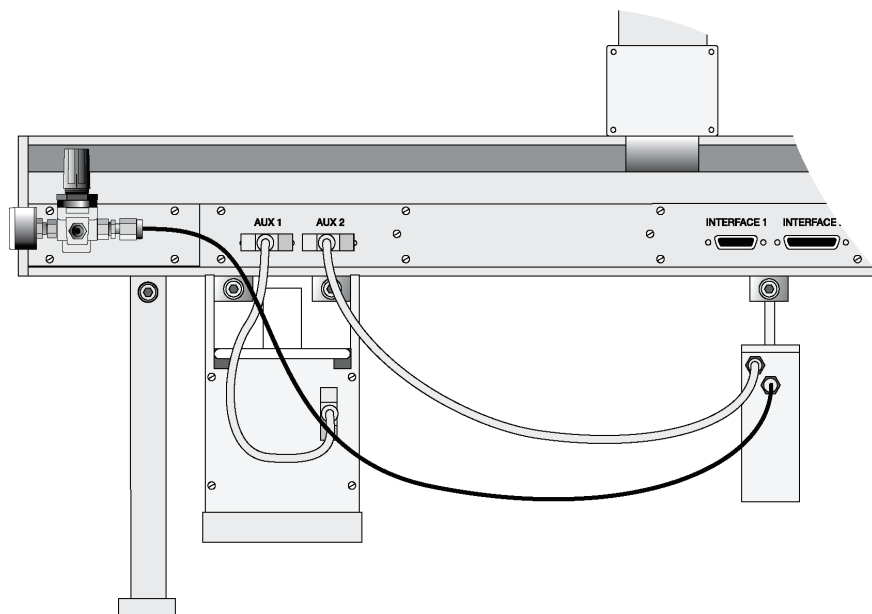

**Figure 2** SPME Fiber Conditioning Station, Electrical and Gas Connections

- 2 Power up the System again. With this warm start, the system again recognizes and references the module connected to “AUX-Interface”.

## Gas-Line Connections

One end of the supplied black gas tube is connected to the flush gas regulator supplied with the Combi PAL, see Chapter “Installation” in the Agilent GC Sampler 80/120 manual.

- 1 Remove the blind-plug at the gas regulator and connect the corresponding reducing union supplied with the installation kit. The other side of the gas tube is connected with a 1/8 inch Swagelok nut to the Fiber Conditioning Station. The installation of this second gas line is displayed in [Figure 3](#) on page 21.

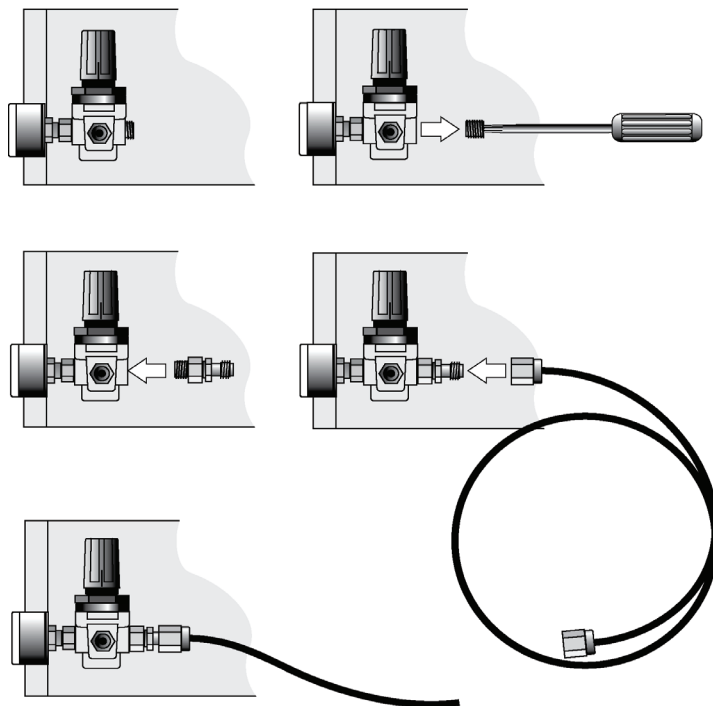

**Figure 3** Gas Tube Connection from Pressure Regulator to SPME Fiber Conditioning Station

## 2 Installation of PAL SPME Fiber Conditioning Station

### PAL Firmware and PAL Object Installation for PAL SPME Fiber Conditioning Station Option

# PAL Firmware and PAL Object Installation for PAL SPME Fiber Conditioning Station Option

## PAL Firmware Installation for SPME Fiber Conditioning Station

The PAL SPME Fiber Conditioning Station option requires PAL Firmware level 2.0.X or higher. If a lower firmware level is installed on the unit in use, an upgrade of the firmware to the current level is recommended.

However the minimum firmware level for the SPME technique should be 2.2.7. or higher.

To backup the configuration see the Agilent GC Sampler 80/120 manual.

## PAL Firmware Object List Installation for the SPME Fiber Conditioning Station

If the revision level of the PAL Object Manager List installed on the computer is lower than “K”, copy the provided folder "PAL SPME Fiber Conditioning Station" from the CD-ROM to the Object List folder which has been installed with the Object Manager. This software is usually installed in the following path:

C:\Program Files\PAL\Object Manager\Object Lists

### 1 Start Object Manager.

The "**PAL SPME Fiber Conditioning Station**" folder should be visible in the structure shown in the window "**Choose Object List Folder**" on the left side of the Object Manager program window.

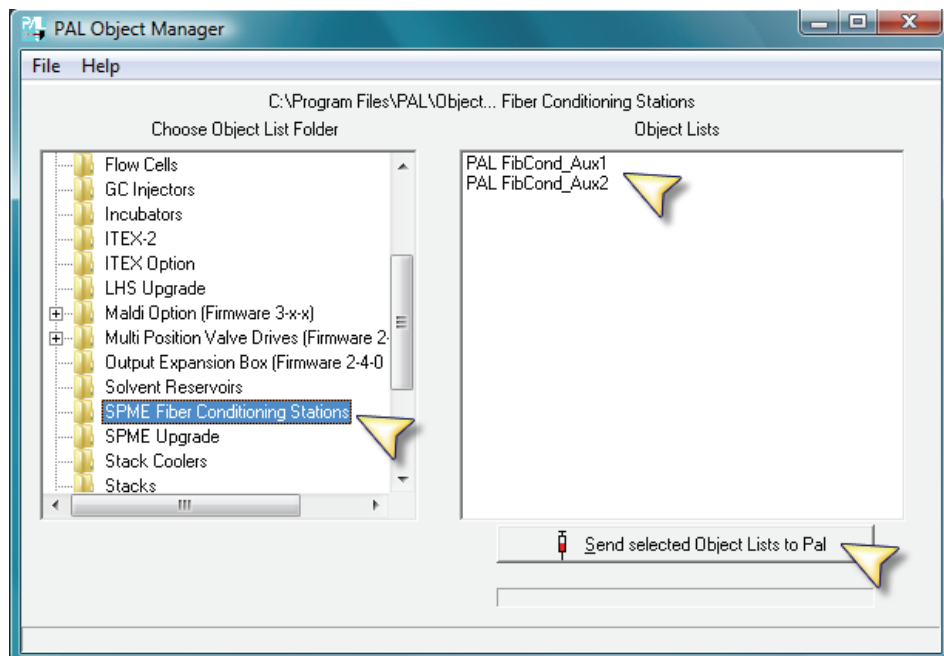

Figure 4 PAL Object Manager “Choose Object List Folder”

### 2 Select the folder “SPME Fiber Conditioning Station” and choose the “SPME Fiber Conditioning Station Option” according to the available “AUX” Interface(s).

## 2 Installation of PAL SPME Fiber Conditioning Station

### PAL Firmware and PAL Object Installation for PAL SPME Fiber Conditioning Station Option

3 Send the selected PAL Firmware Object List to PAL.

#### NOTE

It is assumed that the PAL Firmware has also been prepared for the SPME technique. If this point has been missed, complete the following steps: Select the class “**SPME Upgrade**” in the Object List Folder, then select “**PAL SPMEOpt**” from the Object List.

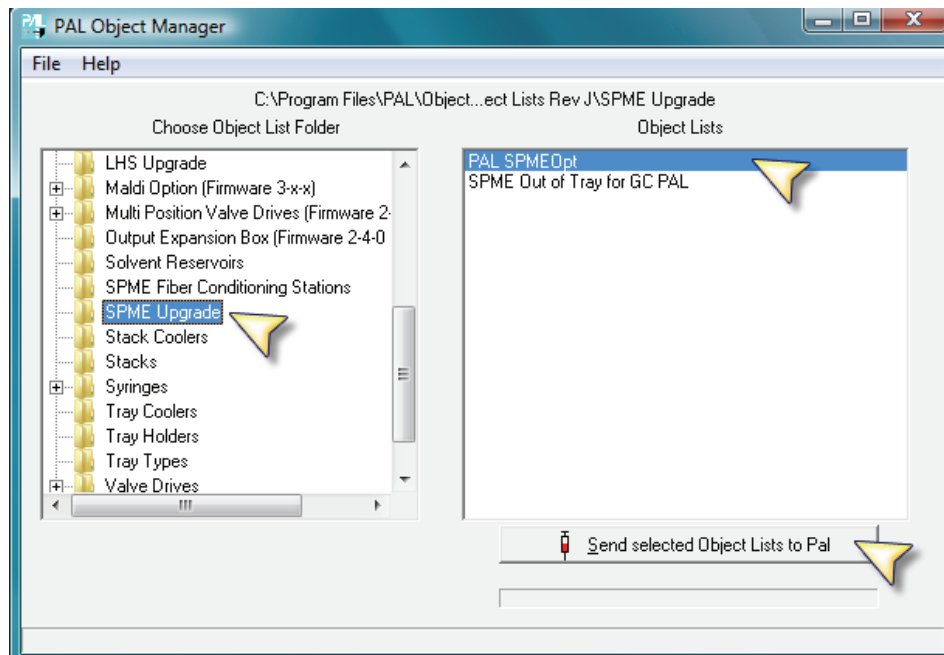

**Figure 5** PAL Object Manager, Send Object “PAL SPMEOpt” to PAL



It is important to understand the meaning of the two Object Lists:

**Table 3** Two object list

<b>PAL SPMEOpt:</b>	This PAL Firmware Object List loads the Objects “ <b>SPME Fiber</b> ” and Position “ <b>FiberExp</b> ”. The two Objects are required to enable the automated SPME technique, either in standalone mode (from local terminal) or by an integration using ICC cycles. The Agitator will be used for this SPME cycle.
<b>SPME Out of Tray:</b>	This PAL Firmware Object List loads the same for GC PAL: Objects but will turn OFF the use of the Agitator. “ <b>Out of Tray</b> ” means that the fiber goes directly to the selected vial in the Tray, not using the temperature stability function from the Agitator.

**NOTE**

Load only the required Object List, do not load both types. In case the Object List “**SPME Out of Tray for GC PAL**” has been added by mistake, add the PAL Firmware Object List for the Incubator (Agitator) to the PAL System. With this step the Agitator is again activated.

For details see also the dedicated User Manual for SPME Technique, which is part of the “SPME Option Kit”.

The PAL SPME Fiber Conditioning Station has the PAL Firmware Object name “**NdlHeater**” and is located in the class “**Injectors**.” The Object “**NdlHeater**” must be positioned in the Agilent GC Injector 80/120. Follow the instructions described in the Agilent GC Injector 80/120 Operating Manual, Chapter “Object Positioning”.

Path:

Menu / Setup / Objects / Injector / NdlHeatr

## 2 Installation of PAL SPME Fiber Conditioning Station

### PAL Firmware and PAL Object Installation for PAL SPME Fiber Conditioning Station Option

Use the rear well with the larger diameter as the teaching point.

The lower needle guide, preferable if a red magnetic ring is installed, must be positioned in the rear well of the SPME Fiber Conditioning Station.

The metallic plate of the injection unit needle guide (bridge) will be positioned on the knob of the gas valve. From this point, turn the Z-axis 2.0 mm further down.

#### NOTE

The motor current for the injection unit used for teaching is not high enough to press down the spring-loaded valve. Position the lower needle guide (bridge) exactly on the knob of the valve. Changing the Z-axis value manually by 2.0 mm further down then defines the correct position for automated routine. The value of “**Needle Penetr**” has been optimized, it is not necessary to change this value.

## Cycle Composer Control

The SPME Fiber Conditioning Station Option can be used in standalone mode or software controlled.

The SPME Fiber Conditioning Station Option can be operated together with the PAL control software Cycle Composer or the Cycle Editor for ICC interpretation in another data handling software. Make sure the hard- and software requirements meet those of your installation before operating the SPME Fiber Conditioning Station.

(See “PAL Hardware Requirements” on page 17 and “Software Requirements” on page 17.)

## Installation of Macros for Cycle Composer

In order to use the SPME Fiber Conditioning Station in an automated manner for the SPME technique, no dedicated Cycle Composer macro is required. The conditioning station is only a tool to clean the fiber. The SPME method, either as used from the local terminal (standalone) or software controlled, such as by Cycle Composer, makes use of the conditioning station if required by the application. The activation of the use is a SPME method parameter, selectable by the user.

If the SPME technique is to be used via software control, Cycle Composer or certain data handling systems that control the PAL using Cycle Editor for PAL interpretation, then it will be necessary to load the corresponding macros for the SPME technique – not for the conditioning station as such.

In case the SPME macro(s) has (have) not been added yet, install the software as described in the “PAL Cycle Composer Software Manual” and add the SPME macros, located in the Combi PAL folder. The provided macros for SPME are installed with this option. To verify this step, navigate in Explorer to the Cycle Composer folder. This is usually installed in the following path:

C:\Program Files\PAL\Cycle Composer

## **2 Installation of PAL SPME Fiber Conditioning Station**

PAL Firmware and PAL Object Installation for PAL SPME Fiber Conditioning Station Option



## 3 PAL SPME Fiber Conditioning Station Operation

Operation and Temperature Setting	30
Temperature Setting	30
Gas Flow Setting	30
SPME Fiber Conditioning Station Operation	31
Using the Front Position to Condition a Spare Fiber	32



## Operation and Temperature Setting

### Temperature Setting

The SPME Fiber Conditioning Station is controlled directly by the Agilent GC Sampler 80/120 firmware. Use the “**Utilities**” section to set the desired temperature for fiber conditioning, “**Standby Temp**”.

Path:

Menu / Utilities / Injector / NdlHeatr

### Gas Flow Setting

The gas flow is regulated by the Flush Gas Pressure Regulator. The setting of the secondary regulator is the same as for Headspace Analysis: approximately 0.5 bar.

The Fiber Conditioning Station has an internal restriction built-in. The typical flow rate yields approx. 6 ml/min if only the rear position is used. If both positions are used (front and rear), the flow is divided approximately in half.

The gas flow for the two positions is pneumatically separated. Both channels can be used independently of each other.

#### NOTE

The restriction is a frit installed in the SwageLok union at the conditioning station housing (connection to the gas tube). In case of blockage, clean the frit with an intense flow of gas from the reverse side or wash in an ultrasonic bath with an appropriate solvent. An aqueous mixture of an alcohol is recommended for washing as good starting point.

## SPME Fiber Conditioning Station Operation

After completing the installation, it is necessary to restart the PAL system. With this warm start the Agilent GC Sampler 80/120 software recognizes and references the SPME Fiber Conditioning Station.

### WARNING

**Flammable and explosive gas**

**Hydrogen is highly flammable and explosive at certain concentrations.**

→ Use an inert gas, such as helium or nitrogen, for the flush gas.

---

The local SPME Cycle (operated standalone) contains the parameter “**Fiber Bakeout**”. If this value is selected (time > 0), the Agilent GC Sampler 80/120 System Injection Unit will go to the conditioning station after the timer for “**Desorb Time**” has reached zero. The fiber will be exposed for the length of time remaining for the “**GC-Runtime**”.

A time setting of zero for “**Fiber Bakeout**” will automatically ignore the use of the SPME Fiber Conditioning Station.

Software controlled operation behaves the same way. Depending on the macro used, the same or similar method variable names are used.

### NOTE

The automated cycle will go to the conditioning station after the first injection. The conditioning station is ignored by the software before the first injection.

The injection unit needle guide will “sit” on the spring loaded gas valve. At this point gas flow is activated. Leaving this position will close the gas valve. Gas consumption is reduced to a minimum.

---

## Using the Front Position to Condition a Spare Fiber

The front position is designed to condition a spare SPME Fiber. The fiber is manually placed into the hole and the fiber is brought to the exposed position. If this second position is used, open the needle valve for gas flow in the second channel (front). The needle valve is the metallic knob in front of the conditioning station.

### NOTE

After the spare fiber has been removed from the front position, it is necessary to close the needle valve in front of the conditioning station (metallic knob). Letting gas flow through this open, second channel would reduce the gas flow in the channel for the automated conditioning to a minimum. This could result in damage to the fiber, as it is not protected by inert gas.

---





## 4 Appendices

Definition of Terms	34
Naming Convention	37
Spare Parts	38



## Definition of Terms

### Job Queue

A Job Queue is a list of sample processing Jobs. Jobs are executed in the order displayed on the JOB QUEUE menu screens. New Jobs may be added to the queue while samples are being processed.

### Job

A Job contains the information needed by the SPME Upgrade to process multiple samples by the same processing steps. The elements of a Job are a Method and a Tray that define the location of the samples to be processed. For identification, Jobs are automatically numbered from 01 to 99 and then restarting with 01 when they are added to the Job Queue.

### Cycle

A Cycle consists of the specific operations necessary to process one sample. The Cycle operations are repeated for each sample within a Job. Cycles are designed for specific applications.

### Method

A Method defines how the samples are processed. The elements of a Method are a Cycle, a Syringe and a Parameter List. Methods have names with up to eight characters and can be edited, copied, and deleted.

### Method Parameters

Method Parameters are associated with the Cycle operations. User-assigned Parameter values define how a processing operation is performed. A zero Parameter value will disable a Cycle operation. Cycle Parameters are application-specific.

### Tray Holder

A Tray Holder can hold one or more trays. Each Tray Holder has a reference position (X-, Y-, Z-coordinates) that defines its location.

## Tray

A Tray holds multiple samples. Trays are defined by designating the Tray Type (see below) and the Tray Holder. Tray names are used to identify the sample source within a Job.

## Tray Type

A Tray Type defines the pattern and sampling sequence of sample locations within a Tray.

## Stack

A Stack is a particular type of Tray Holder that is designed to hold micro-plates. A six-drawer Stack holds 12 standard microplates, two in each drawer.

A three-drawer Stack holds six deep-well micro-plates, two in each drawer.

## Object Manager

Software to load an Object List to an instrument if a Module (hardware module) has been added to the System. In a special mode Object Manager can also be used to create and maintain Object Lists.

## Object List

If a Module (hardware) is added to an instrument, several Objects have to be loaded into the firmware. These Objects are collected in an Object List and stored in a file with the extension “\*.pol”.

Object Lists are delivered together with Object Manager Software and are grouped into folders for the different kind of Modules (e.g. Syringes, Tray Holders, Valve Drives). The name of an Object List starts with the Module part number with variants added (e.g. first or second Stack). The name of the root folder includes the revision which is dependent on the firmware version (e.g. “**Object Lists Rev. K**“ for firmware 2.X and 3.X).

## Object Class

Each Object belongs to an Object Class (e.g. Syringes, Trays, Injectors).

The Object Class defines the Items of an Object.

### **Object Item**

An Object contains several Items which can be numerical values with a physical unit (e.g. X-, Y-, Z-Position, Penetration, Syringe Scale Length, Syringe Volume) or references to other objects.

**NOTE**

The term “Parameter” is reserved for “ATOM Parameter” (Firmware commands to be used for a Cycle).

---

### **Objects**

Objects are data structures describing the properties of physical modules. Certain modules (e.g. a Stack) require several objects.

### **Module**

Hardware module, either part of a standard system configuration (e.g. Agilent LC Injectors HTC/HTS, Agilent GC Sampler 80/120) or an optional addition (e.g. SPME Upgrade for Agilent GC Injector, MT/DW Tray, Stack, and Cooler Upgrades for Agilent LC Injectors HTC/HTS ). The term “Module” is intentionally used to differentiate from “Object”, which is reserved for the Firmware Object.

## Naming Convention

This section recommends standard naming convention for SPME Upgrade Trays, Tray Types, and Tray holders. Following these conventions will allow SPME Upgrade to be pre-configured for certain applications, will simplify software backups and application development, and will improve technical support and training.

**Table 4** Naming Convention

Tray Type	Tray Description
VT200	Vial Tray, 200 positions (10 x 20) For 7 mm micro-vials, 1 ml
VT98	Vial Trays, 98 positions (7 x 14) For 12 mm vials, 2 ml
VT78	Vial Tray, 78 positions (6 x 13) For 7 mm micro-vials, 1 ml (opposite side of 98 positions Tray)
VT54	Vial Tray, 54 positions (6 x 9) For 12 mm vials, 2 ml
VT21	Vial Tray, 21 Positions (7 x 14) For 12 mm vials, 2 ml (opposite side of 32 positions Tray)
VT32-10	Vial Tray, 32 positions (4 x 8) For 23 mm headspace vials, 10 ml
VT32-20	Vial Tray, 32 positions (4 x 8) For 23 mm headspace vials, 20 ml
MT96	Standard 96-position shallow microplate
DW96	Deep well 96-position microplate
MT384	High density 384-position shallow microplate

## Spare Parts

**Table 5** Spare parts

Part Number	Description
G6500-88003	Gas tube fibCond to Pressure regulator incl. swageLok fittings and flow restrictor.

### NOTE

Fibers for the SPME technique are solely sold by Supelco which is today part of Sigma-Aldrich. For details see following web page:

[www.sigmaaldrich.com](http://www.sigmaaldrich.com)

Application notes for the SPME technique are also provided by Supelco. Check the web page: [www.sigmaaldrich.com/spme](http://www.sigmaaldrich.com/spme) to request the "SPME Application CD".

# Index

## A

assembling 19

## C

components 18

condition

    spare fiber 32

connections

    gas-line 21

control

    cycle composer 26

## E

electrical connections 20

## F

firmware

    installation 22

## G

gas flow

    setting 30

## M

macros

    installation 27

## N

naming

    convention 37

## O

object list

    installation 23

## R

requirements

    hardware 17

    software 17

## S

safety information 6

spare parts 38

specifications 17

system

    overview 16

## T

temperature

    setting 30

terms

    definition 34

[www.agilent.com](http://www.agilent.com)

## In This Book

This manual contains technical reference information about the SPME Fiber Conditioning Station for Agilent GC Injector

The manual describes the following:

- safety information
- how to use this manual
- installation
- operation

© Agilent Technologies 2010

Printed in Germany  
08/2010



G6504-90000



**Agilent Technologies**