

ROG Front Base

User Manual

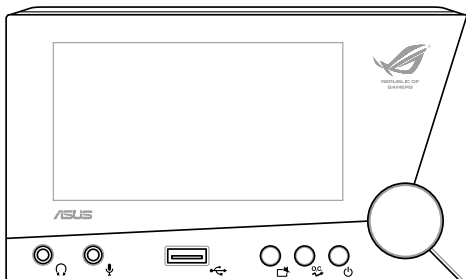

E8699
First Edition
December 2013
Copyright © 2013 ASUSTeK COMPUTER INC.
All Rights Reserved



Contents

Specifications summary	3
Overview.....	4
Hardware Overview	5
Installing the ROG Front Base	7
Installing the driver	10
The ROG Front Base LCD panel	12
Using the ROG Front Base	13
Overclocking with the CPU Level Up OC button	13
Adjusting system fan's duty cycle.....	14
Using the Escape mode button	15
Activating the USB Charger mode	15
Selecting an audio equalization mode.....	16
Adjusting the system volume	16
Understanding the Debug mode	16
Appendix	17
Contact Info.....	18

Specifications summary

Display	4-inch LCD
I/O Ports	1 x USB 2.0 port 1 x Headphone out port 1 x Microphone in port 1 x SATA power connector 1 x 18-1 pin ROG_EXT connector 1 x AAFP connector
Power	Voltage : +12 V, +5 V, +5 VSB Power consumption : 3 A
Dimensions	148.5 mm x 85 mm x 62 mm
Installation requirements	2 x 5.25-inch drive bays required for installation 1 x SATA power cable from system power supply
Compatibility	ROG Maximus VI series, Rampage IV Black Edition, and other motherboards with ROG_EXT port <ul style="list-style-type: none">• Visit the ASUS website at www.asus.com for the latest motherboard support and compatibility lists.• Visit the ASUS Support site at http://support.asus.com to check and download the latest ROG Front Base firmware.• Update the motherboard BIOS to the latest version for better compatibility with your ROG Front Base.
Operating Systems Supported	Windows® 7, Windows® 8, and Windows® 8.1
CPU / Chassis Fan Support	4-pin PWM fan 3-pin DC fan
ROG Unique Features	Easy EQ-switch, CPU Level Up, Escape mode, USB Charger mode, and fan controls and system monitoring

Overview

The ASUS ROG Front Base is a stylish 2-bay front casing accessory that let you perform overclocking on the fly, control the duty cycle settings of installed system fans, and monitor your system's status on its bright 4-inch LCD display.





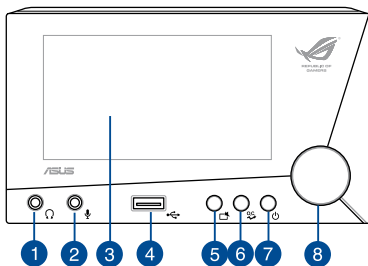

It also features an Escape mode button that instantly hide the gaming screen, mute the volume, and return to the desktop. It comes with five audio equalization (EQ) mode and a USB 2.0 port that can charge your smart devices even when your PC is powered off.

This compact and versatile device also has a debug mode that conveniently displays the status of your system on the device's LCD during the boot-up process.

Hardware Overview

Front view



1	 Headphone out port	Supports headphones and speakers.
2	 Microphone in port	Connects to a microphone.
3	LCD panel	Displays the system time, CPU speed, temperature of motherboard and CPU, system fan duty cycles, audio EQ modes, and the current mode or status of the device.
4	 USB 2.0 port	Charges your smart device when in soft-off mode. Functions as a normal USB 2.0 port when system is on.
5	 Escape mode button	Hides the current screen, mute the sound, and display the desktop.
6	 CPU Level Up OC button	Performs overclocking.
7	 LCD panel power button	Turns the LCD panel display of the ROG Front Base on/off.
8	Selection knob	Rotates to go to the desired item or adjust the values. Confirms changes or selection when pressed.

Rear view

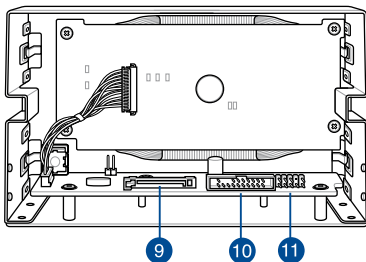

9 SATA power connector	Connects to a SATA power cable from the Power supply for additional power source.
10 ROG_EXT connector	Connects with the motherboard's ROG_EXT connector.
11 AAFP connector	Connects with the motherboard's Front panel audio connector (AAFP) for high-definition audio support.

Installing the ROG Front Base

IMPORTANT!

Allot two (2) empty 5.25-inch drive bays for ROG Front Base installation.

To install the ROG Front Base:

1. Connect the ROG_EXT cable and the AAFP cable to their respective connectors on the ROG Front Base.

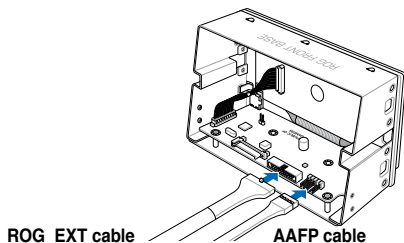

2. Insert the other end of the ROG_EXT cable and the AAFP cable through the two empty 5.25-inch drive trays.

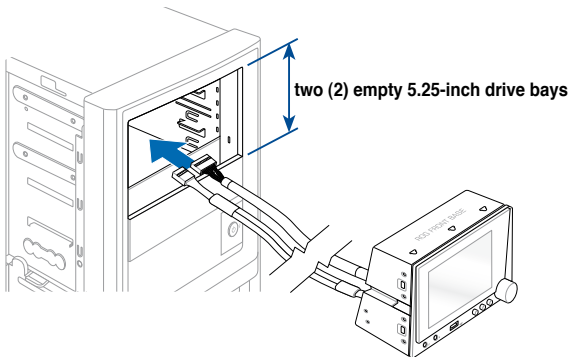

- Align and place the ROG Front Base with its connected cable to the two (2) empty 5.25-inch drive bays.

NOTE: Ensure that the screw holes on the ROG Front Base matches the screw holes on the PC chassis.

- Secure the ROG Front Base to the PC chassis using the bundled set of screws.

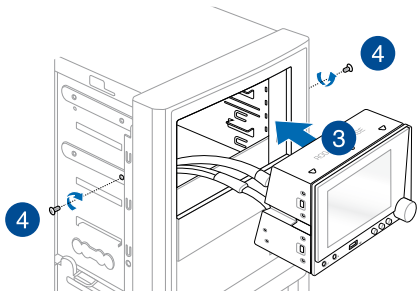

- Connect the other end of the ROG_EXT cable and the AAFP cable to their respective connectors on the motherboard.

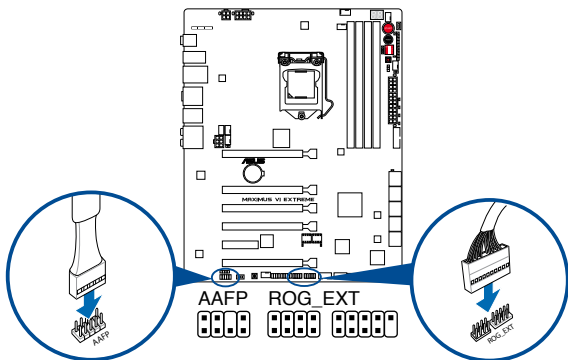

6. Connect a SATA power cable from the power supply and to the SATA power connector on the ROG Front Base.

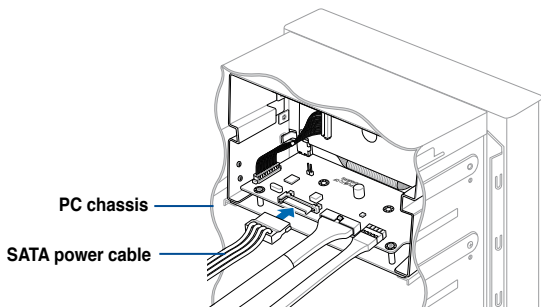

7. Turn on the computer.

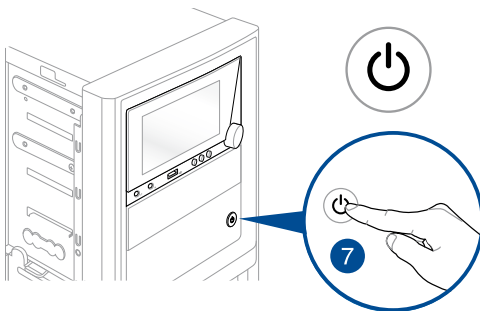

Installing the driver

The support DVD that comes with your ROG Front Base contains drivers to ensure compatibility between the ROG Front Base device and the motherboard.

NOTES:

- The contents of the support DVD are subject to change at any time without notice. Visit the ASUS website at www.asus.com for the latest updates.
- Update your motherboard to the latest BIOS. Refer to your motherboard manual on how to update your BIOS.

To install the ROG Front Base driver:

1. Place the support DVD into the optical drive.

NOTE: If you are running Windows® 8 or Windows® 8.1, launch the **Desktop**.

2. Browse the content then double-click or tap **Setup.exe**.
3. From the ASUS InstAll window, click the **Drivers** tab then click **ASUS InstAll**.



4. Select the **Install drivers and recommended tools automatically from InstAll (recommended)** option button then click **OK**.

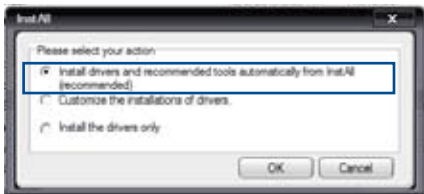

5. From the **ASUS InstAll** window, tick the **ROG Front Base** and **Realtek Audio Driver** check boxes then click **Go**.

Do not turn off your computer during the installation process.

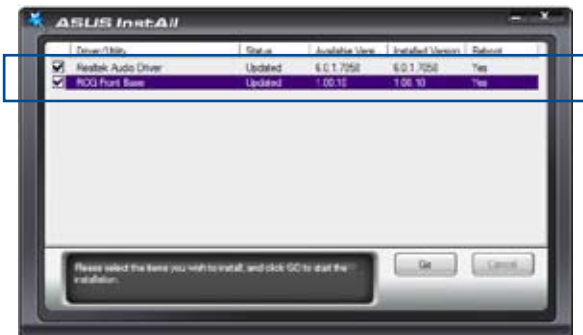

6. When done, follow onscreen instructions to complete the installation.

The ROG Front Base LCD panel

The 4-inch LCD of the ROG Front Base provides at-a-glance view of all the information about your system whether your system is on or powered off.

To turn off/on the LCD, press the LCD panel power button on the front panel.

The LCD panel displays the following information:

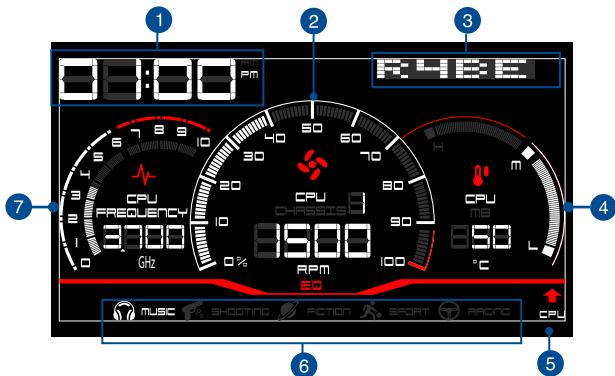

1	Clock	Displays system time.
2	Fan speed gauge	Displays the duty cycles of CPU fans 1 and 2, Chassis fans 1, 2, and 3.
3	Mode/Status indicator	Displays the current status of ROG Front Base. The information displayed vary depending on the mode of the device.
4	Temperature gauge	Displays the CPU and motherboard (MB) temperature.
5	CPU Level Up OC icon	Appears when the CPU Level Up OC button is pressed.
6	Audio Equalization bar	Shows the current audio EQ mode in use.
7	CPU Frequency gauge	Displays the current CPU Frequency or speed.

Using the ROG Front Base

Overclocking with the CPU Level Up OC button

To perform overclocking, press the CPU Level Up OC button on the front panel of the device for an instant CPU performance boosts.

NOTES:

- The following shows the cycle when you press the CPU Level Up OC button repeatedly:



- The overclocking values of LV1 and LV2 depend on the CPU type or motherboard installed.
 - Restore the system to its default settings if the system becomes unstable. For more details, refer to the BIOS section of your motherboard's user manual.
-

Adjusting system fan's duty cycle

Depending on the system fan installed on your system, ROG Front Base allows you to adjust the individual duty cycle of the installed fans.

NOTES:

To control and monitor an installed 3-pin DC control fan or a 4-pin PWM fan using the ROG Front Base, enable each of the fan first in your BIOS.

- To enable the 4-pin PWM fan, go to **BIOS > Monitor > Fan Speed Control** then set CPU Q-Fan Control to **[Auto]**.
 - To enable the 3-pin DC control fan, go to **BIOS > Monitor > Fan Speed Control** then set CPU Q-Fan Control to **[Advance Mode]**.
-

To manually adjust a fan's duty cycle setting:

1. Press and hold the Selection knob until  is displayed on the Mode/Status Indicator.
 2. Rotate the Selection knob to select a fan.
 3. Press the knob to confirm your selection.
 4. Rotate the knob to adjust the value of the fan's duty cycle.
-

NOTE: ROG Front Base allows duty cycle adjustments in percentage (from 0% to 100%) instead of the actual fan speed.

5. Press the Selection knob to confirm the changes.

Using the Escape mode button

The Escape Mode button located on the front panel of the ROG Front Base is a great privacy tool. When pressed, it instantly hides the current screen, mutes the system sound, and displays the desktop.

NOTES:

- To unmute or enable the sound, press the Selection knob repeatedly until  is displayed on the Mode/Status indicator then rotate the Selection knob to adjust the volume to the desired level.
- When the Escape button is pressed, it minimizes the screen of the application to the taskbar. To restore the screen, click the application's icon on the taskbar.

Activating the USB Charger mode

The USB Charger mode allows the USB 2.0 port on the front panel to charge smart devices such as mobile phones and tablets when the system is on the soft-off mode (S5).

To activate the USB Charger mode:

1. While the system is on a soft-off mode (S5), rotate the Selection knob until  is displayed on the Mode/Status Indicator.
2. Press the Selection knob to confirm your selection.
3. Connect the device to charge to the USB 2.0 port.

NOTES:

- USB Charger mode automatically switches to the normal mode when the system is turned on. In normal mode, the USB 2.0 port supports data or digital transmission.
 - For more information on the list of supported devices, visit www.asus.com.
-

Selecting an audio equalization mode

The ROG Front Base has four audio equalization (EQ) modes specifically designed for gaming and a music mode for listening to your favorite audio files.

To select an audio EQ mode, press and hold the Selection knob until **EDIT** is displayed on the Mode/Status Indicator then rotate the Selection knob to select a mode.

Adjusting the system volume

To adjust the system volume, press the Selection knob repeatedly until **EQ** is displayed on the Mode/Status Indicator then rotate the knob to adjust the volume level.

Understanding the Debug mode

The debug mode provides instant information about the status of your system. It is automatically activated, and only active, during the booting process.

In debug mode, the 2-digit error code of the motherboard's Q-Code LED is directly displayed on the device's Mode/Status indicator in real-time during the bootup process.

The debug mode automatically switches to the normal mode after a successful boot and the system is in the Operating System (OS).

NOTE: Refer to your motherboard manual for the complete list of the 2-digit error codes.

DECLARATION OF CONFORMITY

Per FCC Part 2, Section 2.1077(b)



Responsible Party Name: **Asus Computer International**
Address: **880 Corporate Way, Fremont, CA 94539.**

Phone/Fax No: **(510)739-3777/(510)608-4555**

hereby declares that the product

Product Name : Front Panel

Model Number : Front Base

Conforms to the following specifications:

- FCC Part 15, Subpart B, Unintentional Radiators

Supplementary Information:

This device complies with part 15 of the FCC Rules. Operation is subject to the following two conditions: (1) This device may not cause harmful interference, and (2) this device must accept any interference received, including interference that may cause undesired operation.

Representative Person's Name : Steve Chang / President

Signature : 
Date : Jun. 16, 2013

Ver. 12/001

EC Declaration of Conformity



We, the undersigned,

Manufacturer: **ASUS INC. COMPUTER INC.**
Address, City: **#F. NO. 195, LI-FITE RD., TPEIOU, TAIPEI 112, TAIWAN**
Country: **TAIWAN**
Authorized representative in Europe:
Address, City: **ASUS COMPUTER GmbH**
Neudorf Str. 21-23 40880 RATINGEN
Country: **GERMANY**

declare the following apparatus:

Product name : **Front panel**
Model name : **Front Base**

conform with the essential requirements of the following directives:

- 2004/108/EC-EMC Directive**
 - EN 55022:2007-02-01
 - EN 55024:2007-02-01
 - EN 61010-3:2008
 - EN 55022:2007-01-11
- 1999/5/EC-R&TTE Directive**
 - EN 300 328 V1.7 (2005-10)
 - EN 300 440-1 V1.6 (2001-08)
 - EN 300 328 V2.3 (2009)
 - EN 301 878 V1.0 (2003-03)
 - EN 301 878 V1.3 (2005-01)
 - EN 301 908-1 V5.2 (2001-05)
 - EN 301 908 V5.2 (2001-07)
 - EN 301 488-1 V2.1 (2001-08)
 - EN 301 488-1 V2.2 (2001-08)
 - EN 302 320 V1.1 (2005-01)
 - EN 302 320 V1.2 (2007-06)
 - EN 302 320 V1.3 (2007-09)
 - EN 302 320 V1.4 (2007-09)
 - EN 302 291-1 V1.1 (2005-07)
 - EN 302 291-2 V1.1 (2005-07)
- 2006/95/EC-LVD Directive**
 - EN 60950-1 A12/2011
 - EN 60950-2/02/A12/2011
- 2009/125/EC-ERP Directive**
 - Regulation (EC) No. 1275/2008
 - Regulation (EC) No. 642/2009
- 2011/65/EU-RoHS Directive**
 - Regulation (EC) No. 617/2013



(EC conformity marking)

Position : **CEO**
Name : **Jerry Shun**

Signature : 

Declaration Date: **16/08/2013**
Year to begin affixing CE marking: **2013**

Ver. 130816

Contact Info

ASUSTeK COMPUTER INC.

Address	15 Li-Te Road, Peitou, Taipei, Taiwan 11259
Telephone	+886-2-2894-3447
Fax	+886-2-2890-7798
E-mail	info@asus.com.tw
Web site	http://www.asus.com

Technical Support

Telephone	+86-21-3842-9911
Fax	+86-21-5866-8722, ext. 9101#
Online support	http://support.asus.com/techserv/techserv.aspx

ASUS COMPUTER INTERNATIONAL (America)

Address	800 Corporate Way, Fremont, CA 94539, USA
Telephone	+1-510-739-3777
Fax	+1-510-608-4555
Web site	http://usa.asus.com

Technical Support

Support fax	+1-812-284-0883
General support	+1-812-282-2787
Online support	http://support.asus.com/techserv/techserv.aspx

ASUS COMPUTER GmbH (Germany and Austria)

Address	Harkort Str. 21-23, D-40880 Ratingen, Germany
Fax	+49-2102-959931
Web site	http://www.asus.com/de
Online contact	http://eu-rma.asus.com/sales

Technical Support

Telephone	+49-2102-5789555
Support Fax	+49-2102-959911
Online support	http://support.asus.com/techserv/techserv.aspx