

**INSTRUCTION MANUAL
ELECTRONIC TOTAL STATION**

GTS-600 SERIES

- | | |
|------------------|-------------------|
| GTS-601 | GTS-601C |
| GTS-601AF | GTS-601CAF |
| GTS-602 | GTS-602C |
| GTS-602AF | GTS-602CAF |
| GTS-603 | GTS-603C |
| GTS-603AF | GTS-603CAF |
| GTS-605 | GTS-605C |
| GTS-605AF | GTS-605CAF |

FOREWORD

Thank you for purchasing the TOPCON Electronic Total Station, GTS-600 series. For the best performance of the instruments, please carefully read these instructions and keep them in a convenient location for future reference.

General Handling Precautions

Before starting work or operation, be sure to check that the instrument is functioning correctly with normal performance.

Do not aim the instrument directly into the sun .

Aiming the instrument directly into the sun can result in serious damage to the eyes. Damage to the instrument could also result from exposing the instrument's objective lens to direct sunlight. The use of a solar filter is suggested to alleviate this problem.

Setting the instrument on a tripod

When mounting the instrument on a tripod, use a wooden tripod when possible. The vibrations that may occur when using a metallic tripod can effect the measuring precision.

Installing the tribrach

If the tribrach is installed incorrectly , the measuring precision could be effected. Occasionally check the adjusting screws on the tribrach. Make sure the base fixing lever is locked and the base fixing screws are tightened.

Guarding the instrument against shocks

When transporting the instrument, provide some protection to minimize risk of shocks. Heavy shocks may cause the measurement to be faulty.

Carrying the instrument

Always carry the instrument by its handgrip.

Exposing the instrument to extreme heat.

Do not leave the instrument in extreme heat for longer than necessary. It could adversely affect its performance.

Sudden changes of temperature

Any sudden change of temperature to the instrument or prism may result in a reduction of measuring distance range, i.e when taking the instrument out from a heated vehicle. Let instrument acclimate itself to ambient temperature.

Battery level check

Confirm battery level remaining before operating.

Memory back up

The instrument has a built in battery for memory back up. If the battery power is low, "Back up battery empty" will display. Contact your dealer, to replace the battery.

Taking the battery out

It is recommended not to take the battery out during the power is on. All the data stored is possible gone at that time. So please do your assembling or taking the battery out after the power is off.



No responsibility

TOPCON Corporation has no responsibility for loss of data stored in the memory in case unexpected accidents.

Display for Safe Use

In order to encourage the safe use of products and prevent any danger to the operator and others or damage to properties, important warnings are put on the products and inserted in the instruction manuals.

We suggest that everyone understand the meaning of the following displays and icons before reading the "Safety Cautions" and text.

Display	Meaning
 WARNING	Ignoring or disregard of this display may lead to the danger of death or serious injury.
 CAUTION	Ignoring or disregard of this display may lead to personal injury or physical damage.

•Injury refers to hurt, burn, electric shock, etc.

•Physical damage refers to extensive damage to buildings or equipment and furniture.

Safety Cautions

 WARNING
<ul style="list-style-type: none"> •There is a risk of fire, electric shock or physical harm if you attempt to disassemble or repair the instrument yourself. This is only to be carried out by TOPCON or an authorized dealer, only!
<ul style="list-style-type: none"> •Cause eye injury or blindness. Do not look at the sun through a telescope.
<ul style="list-style-type: none"> •Laser beams can be dangerous, and can cause eye injury's if used incorrectly. Never attempt to repair the instrument yourself. (Only for Laser plummet type)
<ul style="list-style-type: none"> •Cause eye injury or blindness. Do not stare into beam. (Only for Laser plummet type)
<ul style="list-style-type: none"> •High temperature may cause fire. Do not cover the charger while it is charging.
<ul style="list-style-type: none"> •Risk of fire or electric shock. Do not use damaged power cable, plug and socket.
<ul style="list-style-type: none"> •Risk of fire or electric shock. Do not use a wet battery or charger.
<ul style="list-style-type: none"> •May ignite explosively. Never use an instrument near flammable gas, liquid matter, and do not use in a coal mine.
<ul style="list-style-type: none"> •Battery can cause explosion or injury. Do not dispose in fire or heat.
<ul style="list-style-type: none"> •Risk of fire or electric shock. Do not use any power voltage except the one given on manufacturers instructions.
<ul style="list-style-type: none"> •Battery can cause outbreak of fire. Do not use any other type of charger other than the one specified.
<ul style="list-style-type: none"> •Risk of fire. Do not use any other power cable other than the one specified.
<ul style="list-style-type: none"> •The short circuit of a battery can cause a fire. Do not short circuit battery when storing it.

 CAUTION
•Use of controls or adjustment or performance of procedures other than those specified herein may result in hazardous radiation exposure. (Only for Laser plummet type)
•Do not connect or disconnect equipment with wet hands, you are at risk of electric shocks if you do!
•Risk of injury by overturn the carrying case. Do not stand or sit on the carrying cases.
•Please note that the tips of tripod can be hazardous, be aware of this when setting up or carrying the tripod.
•Risk of injury by falling down the instrument or case. Do not use a carrying case with a damaged which belts, grips or latches .
•Do not allow skin or clothing to come into contact with acid from the batteries, if this does occur then wash off with copious amounts of water and seek medical advice.
•A plumb bob can cause an injury to a person if used incorrectly.
•It could be dangerous if the instrument falls over, please ensure you attach a handle batter the instrument securely.
•Ensure that you mount the Tribach correctly, failing to do so may result in injury if the tribrach were to fall over.
•It could be dangerous if the instrument falls over, please check that you fix the instrument to the tripod correctly.
•Risk of injury by falling down a tripod and an instrument. Always check that the screws of tripod are tightened.

User

- 1) This product is for professional use only!
The user is required to be a qualified surveyor or have a good knowledge of surveying, in order to understand the user and safety instructions, before operating, inspecting or adjusting.
- 2) Wear the required protectors (safety shoes, helmet, etc.) when operating.

Exceptions from Responsibility

- 1) The user of this product is expected to follow all operating instructions and make periodic checks of the product's performance.
- 2) The manufacturer, or its representatives, assumes no responsibility for results of a faulty or intentional usage or misuse including any direct, indirect, consequential damage, and loss of profits.
- 3) The manufacturer, or its representatives, assumes no responsibility for consequential damage, and loss of profits by any disaster, (an earthquake, storms, floods etc.).
A fire, accident, or an act of a third party and/or a usage any other usual conditions.
- 4) The manufacturer, or its representatives, assumes no responsibility for any damage, and loss of profits due to a change of data, loss of data, an interruption of business etc., caused by using the product or an unusable product.
- 5) The manufacturer, or its representatives, assumes no responsibility for any damage, and loss of profits caused by usage except for explained in the user manual.
- 6) The manufacturer, or its representatives, assumes no responsibility for damage caused by wrong movement, or action due to connecting with other products.

Safety Standard for Laser Beam

GTS-600 series Laser plummet type use a visible laser beam to perform the plumb laser function. The GTS-600 series Laser plummet type products are manufactured and sold in accordance with "Radiation Safety of Laser Products, Equipment Classification, Requirements and User's Guide" (IEC Publication 825) or "Performance Standards for Light-Emitting Products" (FDA/BRH 21 CFR 1040) regarding the safety standard for laser products.

As per these standards, the GTS-600 series Laser plummet type is classified as "Class II (2) Laser Products".

Since Laser radiation is emitted from the GTS-600 series Laser plummet type instruments, please refer to the "Laser Safety" bulletin which accompanies the instrument in the United States as well as the "Safety Standard for Users" that is mentioned in the instruction manual. In the case of any technical failure, do not disassemble the instrument. Contact either TOPCON or your authorized TOPCON dealer.

Caution:

Use of controls or adjustments or performance of procedure than those specified in this manual may result in hazardous radiation exposure.

Labels

The following labels are found on the instruments which describe the GTS-600 series Laser plummet type: Precautions and safety information about the laser beam.

If, at any time, any of these labels are damaged and become illegible, please replace these important labels. Please the new labels in exactly the same position as the original labels. Replacement labels can be obtained from Topcon or your authorized Topcon dealer.

GTS-600 series Laser Plummet type

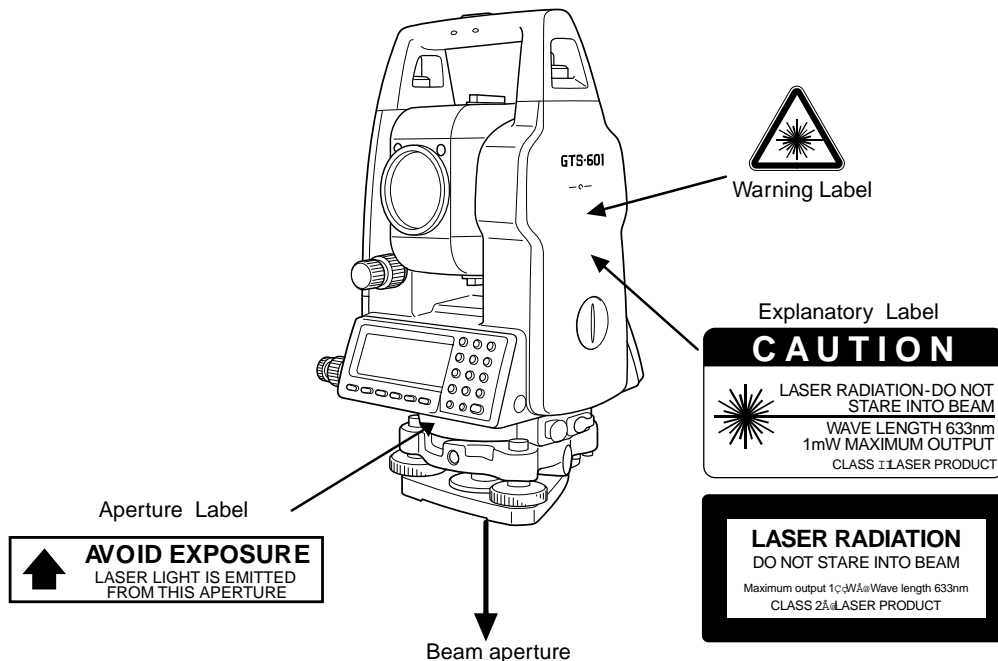

Depending on the country where the instrument is sold, either of these labels may be found on the GTS-600 series laser plummet type.

Contents

FOREWORD	1
General Handling Precautions	1
Display for Safe Use	2
Safety Cautions	2
User	3
Exceptions from Responsibility	3
Safety Standard for Laser Beam	4
Contents	5
Standard Set Composition	7
1 NOMENCLATURE AND FUNCTIONS	1-1
1.1 Nomenclature	1-1
1.2 Display	1-4
1.3 Operating Key	1-5
1.4 Function Key (Soft Key)	1-5
1.5 Star key mode	1-7
1.6 Auto Power Off	1-10
1.7 Automatic Focusing (Only for Automatic Focusing model)	1-11
2 PREPARATION FOR MEASUREMENT	2-1
2.1 Power Connection	2-1
2.2 Setting Instrument Up For Measurement	2-2
2.3 Power Switch Key ON	2-3
2.4 Battery Power Remaining Display	2-4
2.5 Main Menu Contains	2-5
2.6 Vertical and Horizontal Angle Tilt Correction	2-6
2.7 Compensation of Systematic Error of Instrument	2-7
2.8 Resume Mode ON/OFF	2-8
2.9 How to Enter Numerals and Alphabet Letters	2-8
2.10 Data Memory Card (Only for Card model)	2-9
3 STANDARD MEASUREMENT MODE	3-1
3.1 Angle Measurement	3-1
3.1.1 Measuring Horizontal Angle Right and Vertical Angle	3-1
3.1.2 Switching Horizontal Angle Right/Left	3-2
3.1.3 Measuring from the Required Horizontal Angle	3-2
3.1.4 Vertical Angle Percent Grade(%) Mode	3-3
3.2 Distance Measurement	3-4
3.2.1 Setting of the Atmospheric Correction	3-4
3.2.2 Setting of the Correction for Prism Constant	3-4
3.2.3 Distance Measurement (Continuous Measurement)	3-4
3.2.4 Distance Measurement (Single/N-times Measurement)	3-5
3.2.5 Fine/ Tracking / Coarse Measuring Mode	3-7
3.2.6 Stake Out (S-O)	3-8
3.3 COORDINATE MEASUREMENT	3-9
3.3.1 Setting Coordinate Values of Occupied Point	3-9
3.3.2 Setting of the Instrument Height / Prism Height	3-11
3.3.3 Execution of Coordinate Measuring	3-12
3.4 DATA OUTPUT	3-14
3.5 DATA Output by soft key (REC)	3-15
4 PROGRAM MODE	4-1
4.1 Setting a Direction Angle for Backsight Orientation	4-2
4.2 Retaining a Coordinate (STORE- NEZ)	4-3
4.3 Remote Elevation measurement (REM)	4-5
4.4 Missing Line Measurement (MLM)	4-8
4.5 Repetition Angle Measurement (REP)	4-10
4.6 Layout	4-12
4.6.1 Options	4-13
4.6.2 Coordinate Data	4-22
4.6.3 Search Data and View Jobs	4-24
4.6.4 New Point	4-26
4.6.5 Grid Factor	4-31
4.6.6 Setting a Direction Angle and Layout a Point	4-33

4.6.7 Guidance Feature	4-37
4.7 Line Measurement (LINE)	4-38
4.8 Offset measurement (OFFSET)	4-41
4.8.1 Angle Offset	4-42
4.8.2 Distance Offset Measurement	4-44
4.8.3 Plane Offset Measurement	4-46
4.8.4 Column Offset Measurement	4-48
4.9 LOADER option	4-50
5 MEMORY MANAGE MODE	5-1
5.1 View Internal Memory Status (for normal model)	5-1
5.2 View Internal Memory and Card Memory Status (for Card model)	5-1
5.3 Protecting a File	5-2
5.4 Rename a File	5-3
5.5 Deleting a File	5-4
5.6 Copying a File (only for Card model)	5-5
5.7 Initializing Internal Memory or Card Memory	5-6
6 COMMUNICATION MODE	6-1
6.1 Setting of PROTOCOL	6-1
6.2 Data file in	6-2
6.3 Data file out	6-3
7 PARAMETERS SETTING MODE	7-1
7.1 Parameter Setting Options	7-1
7.1.1 Parameters for Measurement and Display	7-1
7.1.2 Parameters for communication	7-3
7.2 Setting Parameters	7-4
7.2.1 Parameters for Measurement and Display	7-4
7.2.2 Parameters for communication	7-5
7.2.3 Password option	7-6
8 CHECK AND ADJUSTMENT	8-1
8.1 Checking and adjusting of instrument constant	8-1
8.2 Checking the Optical Axis	8-2
8.3 Checking/Adjusting the Theodolite Functions	8-3
8.3.1 Checking /Adjusting the Plate Level	8-4
8.3.2 Checking /Adjusting the Circular Level	8-4
8.3.3 Adjustment of the Vertical Cross-hair	8-5
8.3.4 Collimation of the Instrument	8-6
8.3.5 Checking / Adjusting the Optical Plummet Telescope	8-7
8.3.6 Checking / Adjusting the Laser Plummet (For Laser Plummet type)	8-8
8.4 Adjustment of Compensation Systematic Error of Instrument	8-9
8.5 Showing Constant List and Switch ON/OFF	
Compensation Systematic Error of Instrument	8-11
8.6 How to adjust the date and time	8-12
8.7 How to Set the Instrument Constant Value	8-13
8.8 Reference Frequency Checking Mode	8-14
9 SETTING THE PRISM CONSTANT VALUE	9-1
10 SETTING ATMOSPHERIC CORRECTION	10-1
10.1 Calculation of Atmospheric Correction	10-1
10.2 Setting of Atmospheric Correction Value	10-1
11 CORRECTION FOR REFRACTION AND EARTH CURVATURE	11-1
11.1 Distance Calculation Formula	11-1
12 POWER SOURCE AND CHARGING	12-1
12.1 On-board Battery BT-50Q	12-1
13 DETACH/ATTACH OF TRIBRACH	13-1
14 SPECIAL ACCESSORIES	14-1
15 BATTERY SYSTEM	15-1
16 PRISM SYSTEM	16-1
17 PRECAUTIONS	17-1

18 ERROR DISPLAYS **18-1**
19 SPECIFICATIONS **19-1**
APPENDIX **APPENDIX-1**
 Dual Axis Compensation APPENDIX-1
 Precaution when Charging or Storing Batteries..... APPENDIX-3

Standard Set Composition

1) GTS-600 series (with lens cap) 1 each
 2) Battery BT-50Q 1 each
 3) Battery charger BC-27BR or BC-27CR 1 each
 4) Tool kit with case [rod pins, screwdriver, cleaning brush] 1 set
 5) Plastic carrying case 1 each
 6) Sun shade 1 each
 7) Plastic rain cover 1 each
 8) Silicon cloth 1each
 9) Instruction manual 1 each

(Make sure that all of the above items are with the instrument when purchased.)

Remarks:
 1) Battery charger BC-27CR is for AC 230V use and BC-27BR is for AC 120V use.
 2) Plumb bob set and plumb bob hook are supplied for certain markets.
 3) Additional on-board battery BT-50Q is included for certain markets

1 NOMENCLATURE AND FUNCTIONS

1.1 Nomenclature

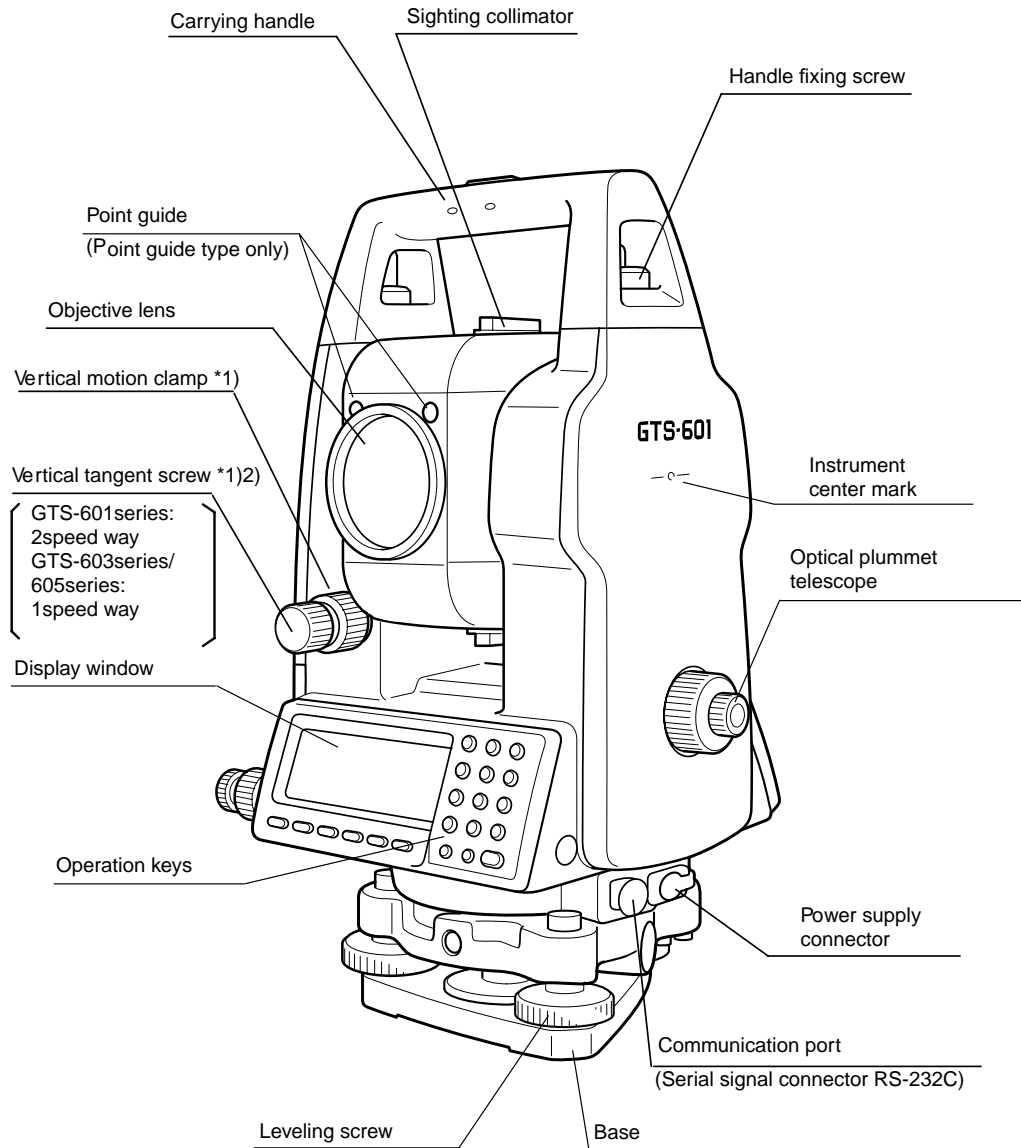

*1) The position of vertical motion clamp and tangent screw will differ depend on the markets.
 *2) The speed of vertical tangent screw will differ depend on the markets.

1 NOMENCLATURE AND FUNCTIONS

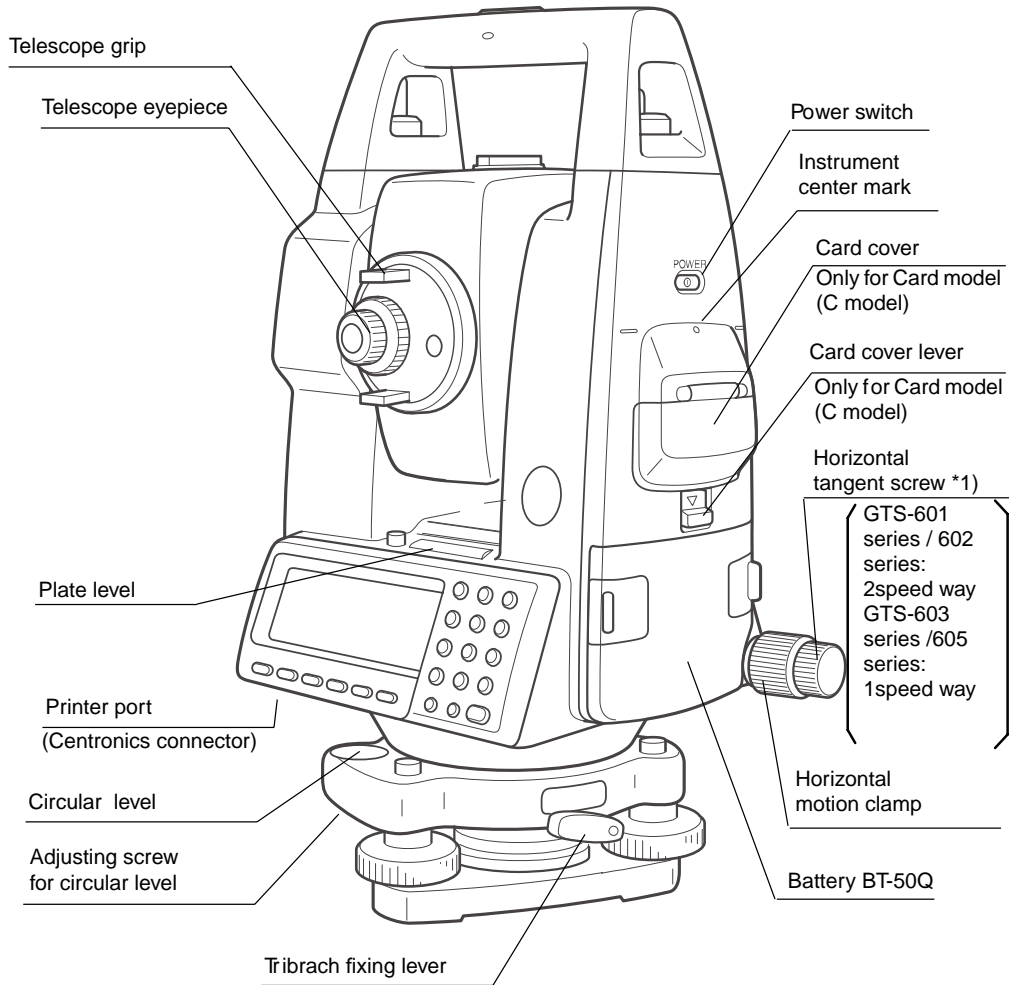

*1) The speed of vertical tangent screw and horizontal tangent screw will differ depend on the markets.

Auto-focus model

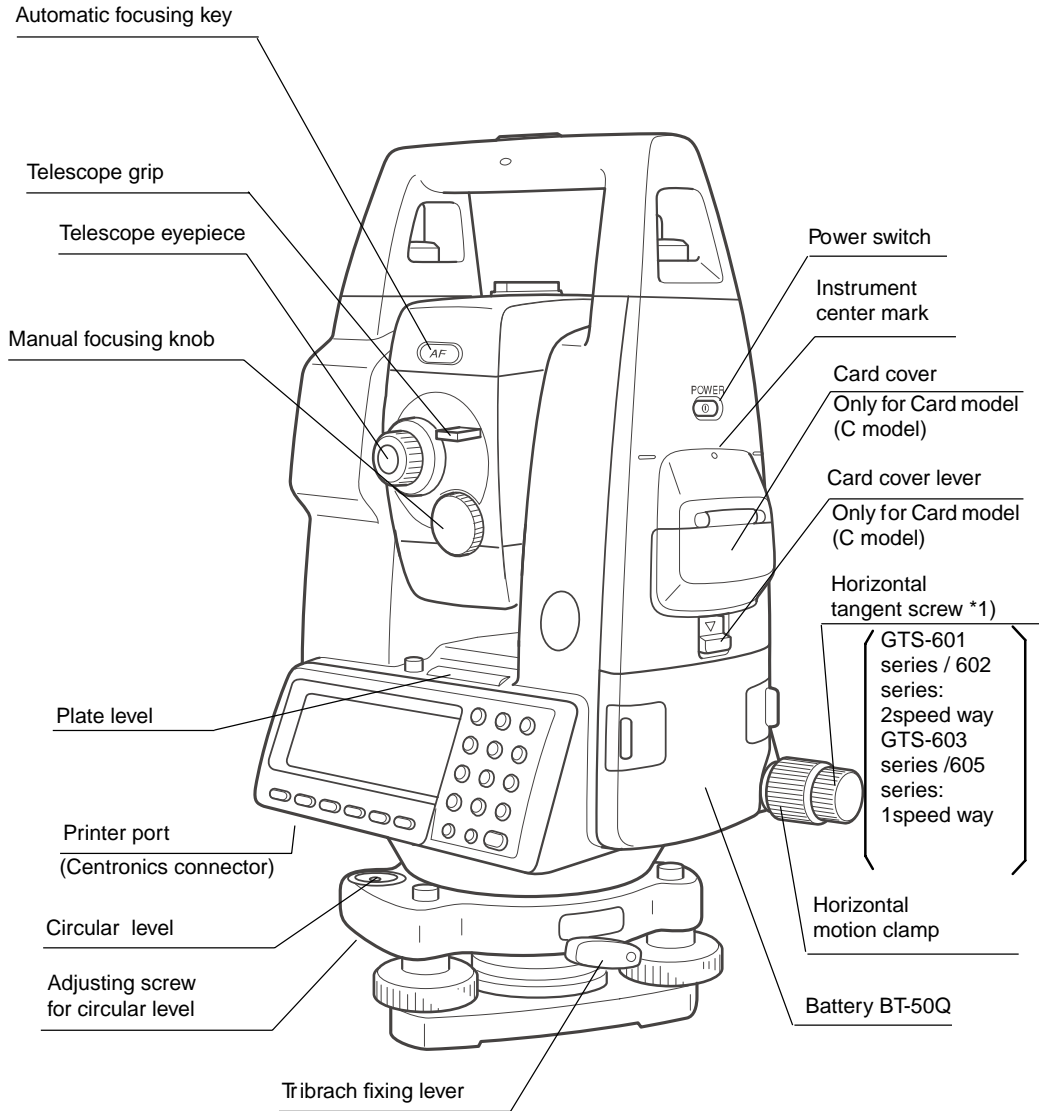

*1) The speed of vertical tangent screw and horizontal tangent screw will differ depend on the markets.

1.2 Display

- Display**
 In general upper fore lines display the measuring data, and the bottom line displays the soft key function which is changed by the measuring mode.
- Contrast**
 The contrast and illumination of display window are adjusted by star (★)key.
- Heater (Automatic)**
 The built-in automatic heater functions when the temperature is below 0°C. This keeps the display's speed up at temperatures lower than 0°C. To set the heater ON/OFF, see Chapter 7 "PARAMETERS SETTING MODE".
- Example**

```
V : 87°55'20"
HR: 180°44'12"

SD HD NEZ OSET HOLD P1 ↓
```

Angle measurement mode

V-angle : 87°55'20"
 H-angle : 180°44'12"

```
V : 87°55'40"
HR: 180°44'12" PSM 0.0
SD: 12.345 PPM 0.0
(m) *F.R
MEAS MODE VH HD NEZ P1 ↓
```

Distance measurement mode

Horizontal-angle : 87°55'40"
 Horizontal distance : 180°44'12"
 Relative elevation : 12.345m

- Display marks**

Display	Contents	Display	Content
V	V -angle	(m)	Meter unit
V%	Percent grade	(f)	Feet unit
HR	H-angle right	F	Fine mode
HL	H-angle left	C	Coarse mode
HD	Horizontal distance	T	Tracking mode
VD	Relative elevation	R	Repeat measurement
SD	Slope distance	S	Single measurement
N	N coordinate	N	N-times measurement
E	E coordinate	ppm	Atmospheric correction value
Z	Z coordinate	psm	Prism constant value
*	EDM working		

1.3 Operating Key

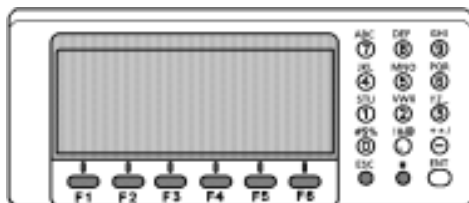

Keys	Name of Key	Function
F1-F6	Soft key	Functions are according to the displayed message.
0-9	Numeric key	Entering numerals.
A ~/	Alpha key	Entering Alphabets.
ESC	Escape key	Returning to the previous mode or display.
★	Star key	Star key mode is used for each presetting or displaying.
ENT	Enter key	Press at the end of inputting values.
POWER	Power key	ON/OFF of power source. (Power key is located on the side of the instrument.)

1.4 Function Key (Soft Key)

The Soft Key message is displayed at the bottom line of display. The functions are according to the displayed message.

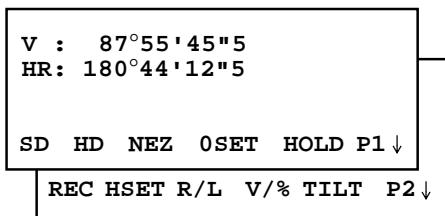
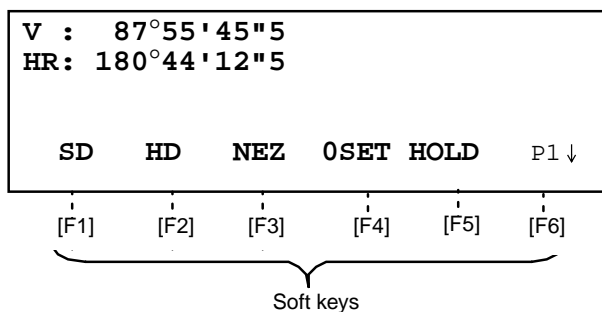

Angle measuring

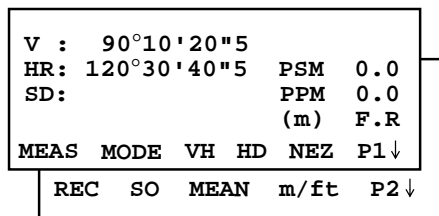

Slope distance measuring

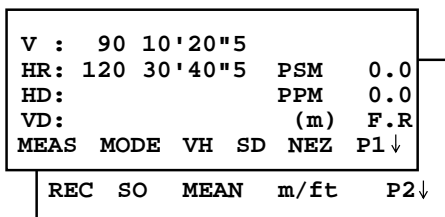

Horizontal distance measuring

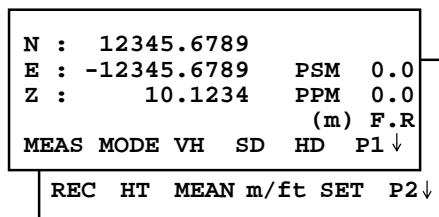

Coordinate measuring

1 NOMENCLATURE AND FUNCTIONS

Page	Display	Soft key	Function
Angle measuring	SD	F1	To be slope distance measuring mode.
	HD	F2	To be horizontal distance measuring mode.
	NEZ	F3	To be coordinate distance measuring mode.
	OSET	F4	Angle of horizontal is set to 0 00'00".
	HOLD	F5	Hold the horizontal angle.
	REC	F1	To be measurement data record mode.
	HSET	F2	Sets the horizontal angle by input value.
	R/L	F3	Switches R/L rotation of horizontal angle.
	V/%	F4	Switches the vertical angle and percent grade
	TILT	F5	Sets the tilt function, ON/OFF. If ON, the display shows tilt correction value.
Slope distance measuring	MEAS	F1	Slope distance measuring starts. Switches Continuous/ N-times (Single) measurement mode.
	MODE	F2	Set to the mode for Tracking , Coarse or Fine.
	VH	F3	To be angle measurement mode.
	HD	F4	To be horizontal distance measurement mode.
	NEZ	F5	To be coordinate measurement mode.
	REC	F1	To be measurement data record mode.
	SO	F2	To be stake out measurement mode.
	MEAN m/ft	F3 F4	Sets the number of N-time measurement. Switches meter or feet unit.
Horizontal distance measuring	MEAS	F1	Horizontal distance measuring starts. Switches Continuous/ N-times (Single) measurement mode.
	MODE	F2	Set to the mode for Tracking , Coarse or Fine.
	VH	F3	To be angle measurement mode.
	SD	F4	To be slope distance measurement mode.
	NEZ	F5	To be coordinate measurement mode.
	REC	F1	To be measurement data record mode.
	SO	F2	To be stake out measurement mode.
	MEAN m/ft	F3 F4	Sets the number of N-time measurement. Switches meter or feet unit.
Coordinate measuring	MEAS	F1	Coordinate measuring starts. Switches Continuous/ N-times (Single) measurement mode.
	MODE	F2	Set to the mode for Tracking , Coarse or Fine.
	VH	F3	To be angle measurement mode.
	SD	F4	To be slope distance measurement mode.
	HD	F5	To be horizontal distance measurement mode.
	REC	F1	To be measurement data record mode.
	HT	F2	Sets an Instrument Height / Prism Height by input values.
	MEAN m/ft	F3 F4	Sets the number of N-time measurement. Switches meter or feet unit.
	SET	F5	Sets an instrument coordinate point by input values.

1.5 Star key mode

Press the (★)key to view the instrument options. Since there are two screens of options, press [F6] (1↓) soft key to view the next screen.

The following instrument options can be selected from the (★):

• **Screen One**

1. View Date & Time
2. Adjustment the contrast of the display [F1 & F2]
3. Turn the backlight of the display ON/OFF [F3]
4. Reticle illumination--ON(1to9 steps) / OFF [F4]
5. View free memory for internal memory [F5]
(Card model can be displayed free memory for card memory.)

• **Screen Two**

6. Electric circular graphic display[F1]
7. The light acceptance quantity level (signal level) is displayed.[F2]
8. Set the Temperature, Pressure, Atmospheric Correction Value (PPM), and Prism Constant Value (PSM) [F3]
9. Turn the Point Guide option ON/OFF [F4](Only for point guide type)
10. Turn the Laser Plummet ON/OFF [F5] (Only for laser plummet type)

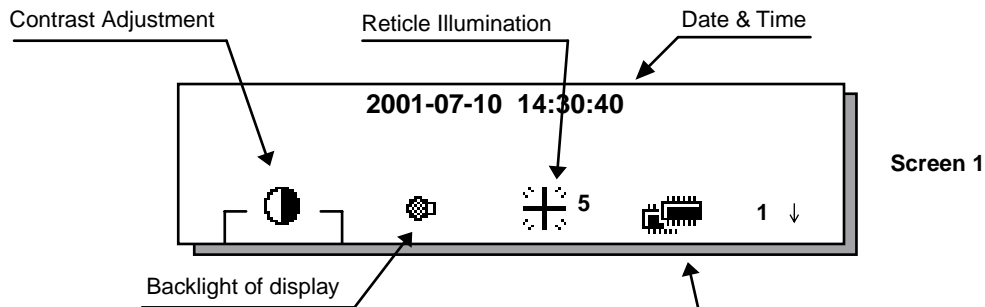

Displaying the Internal Memory Capacity
Card model can display free memory for the Internal Memory and Card memory. The icon will change as follows.

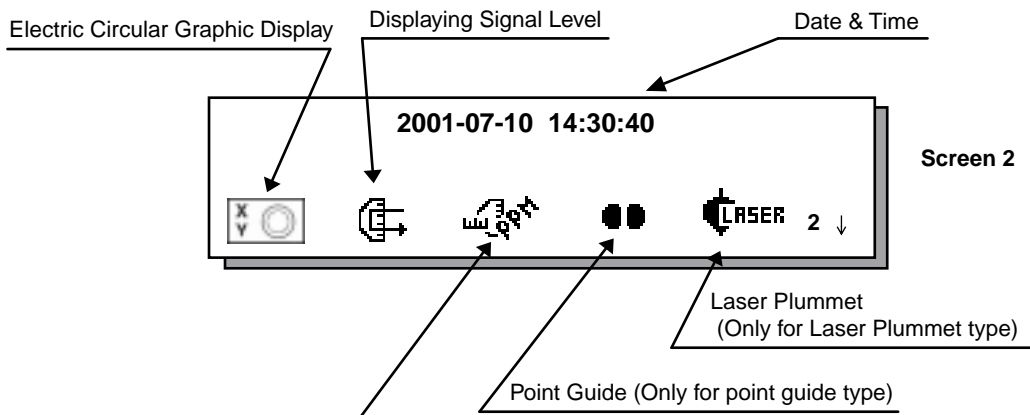

Set the Temperature, Pressure, Atmospheric Correction Value (PPM), and Prism Constant Value (PSM)

1 NOMENCLATURE AND FUNCTIONS

•Screen one

1. View Date & Time

The date and time can be viewed on both screens. To change the displayed order of the date, (Date/Month/Year), (Month/Date/Year) or (Year/Month/Date), see Chapter 7 "PARAMETERS SETTING MODE".

To set the date and time, see Chapter 8 "CHECK AND ADJUSTMENT" .

2. Adjustment the contrast of the display

This enable you to adjust the contrast of the display.

Press the [F1] or [F2] key to adjust the contrast.

3. Turn the display back light ON/OFF

When the back light is OFF, the light bulb icon is dark.

To turn the back light ON, press the [F3] key. Press [F3] again to turn the back light OFF.



4. Reticle illumination ON (1 to 9) / OFF

Press the [F4] key to turn the reticle illumination ON. Select the brightness by pressing numeric key To turn the illumination OFF, press [F4] key again.

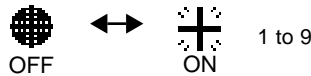

5. View free memory

The amount of free memory for the internal memory can be displayed.

Press the [F5] key to view free memory.

The icon shows the size of the amount of free internal memory.

Card model can display free memory for the Internal Memory and Card memory.

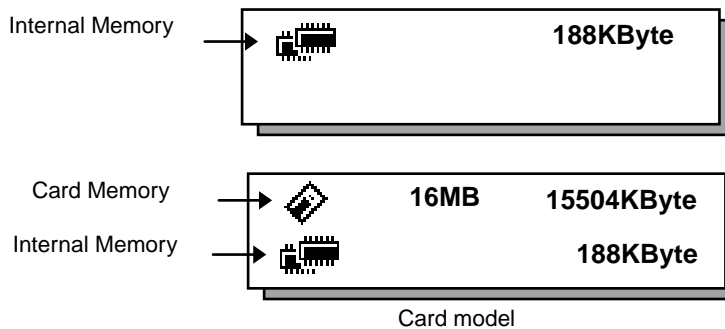

Refer to Chapter 5 -MEMORY MANAGE MODE, for further options and instructions.

1 NOMENCLATURE AND FUNCTIONS

- **Screen two**

6. Electric circular level graphic display

Electric circular level can be displayed by graphic. This function is good for level the instrument when the circular level is difficult to see directly.

Press the [F6] key to get to Screen 2 on the display.

Press the [F1] key to display the graphic.

In the displays of reverse side, the graphic bubble moves in reverse.

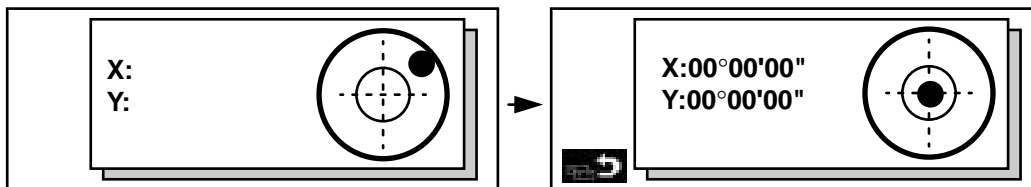

Rotate the leveling screws while observing the display.

After leveling, press [F1]. The display changes to the previous mode.

7. Set audio mode

The light acceptance quantity level (Signal level) is displayed in this mode.

When reflected light from the prism is received, a buzzer sounds. This function is good for easy collimation when the target is difficult to find.

Press the [F6] key to get to Screen 2 on the display then press the [F2] key on screen 2.

The received return signal level is displayed with bar graph as follows.

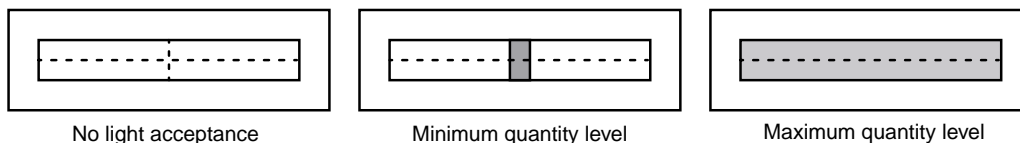

(1) To stop the buzzer, refer to Chapter 7 "PARAMETERS SETTING MODE".

(2) Also, it is possible to display the signal level in Distance Measuring Mode.

8. Setting Temperature, Pressure, Atmospheric correction value (PPM), Prism constant value (PSM)

Press the [F6] key to get to Screen 2 on the display then press the [F3] key on screen 2.

The temperature, pressure, PPM, and PSM can be viewed.

Refer to Chapter 9 "SETTING THE PRISM CONSTANT VALUE" and Chapter 10 "SETTING ATMOSPHERIC CORRECTION", for further instructions.

9. Point guide (Only for Point guide type)

This feature is most useful when doing stake out work. The Point Guide's red LEDs on the GTS-600 Series telescope assist the rod person in getting on-line. The Point Guide feature is fast and simple to use.

- **Operating Instructions**

Press the [F6] key to get to Screen 2 on the display then press the [F4] key to turn ON the Point Guide LEDs. The Point guide icon on the display will become bright when turned ON.

Looking the objective lens of the telescope, the right LED will blink and the left LED will stay lit.

1 NOMENCLATURE AND FUNCTIONS

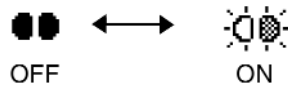

The Point Guide should be used within a distance of 100 meters (328 ft.). The quality of its results will depend on the weather conditions and the user's eyesight.

The goal of the rod person is to look at both LEDs on the instrument and move the prism on-line until both LEDs become equally bright. If the solid LED is brighter, move to the right. If the blinking LED is brighter, move to the left.

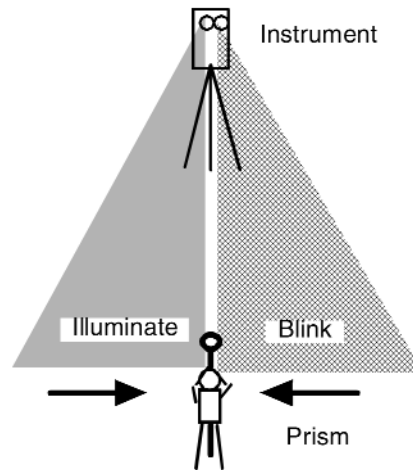

10. Laser Plummet (Only for Laser Plummet type)

Laser plummet option will help you to center the instrument easily onto the measurement point. Press the (•) key to view the instrument options. Since there are two screens of options, press [F6](1 •) soft key to view the next screen. Press the [F5]key to turn on/off of laser plummet option. Laser plummet icon will change as follows.



Symbol mark while the laser is emitting.

The following symbol mark will indicate that the laser is emitting.

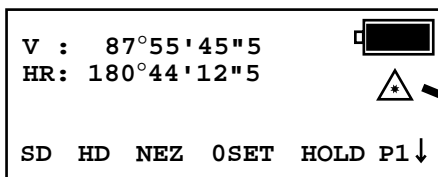

The symbol mark will blink while the laser plummet is working

Laser Plummet auto-cut off function

The laser plummet will be turned off automatically after 1 to 99 minutes (Default:3 minutes). It is also possible to stop the auto-cut off function.

Refer to the next page and Chapter 7 "PARAMETERS SETTING MODE" to change the time or to invalidate the function.

1.6 Auto Power Off

If no key operation is given for the setting time(1 to 99 minutes), the power turns off automatically.

To set the Auto Power Off function OFF/ON(1 to 99 minutes), refer to Chapter 7 "PARAMETERS SETTING MODE".

To set the time of auto power off in parameters setting mode, after selecting [ON], input the time by numeric key.

1.7 Automatic Focusing (Only for Automatic Focusing model)

The automatic focusing is useful for rapid surveying.

Press the automatic focusing key after sighting a target by using with the sighting collimator. The automatic focusing will start with a "bip" sound.

The automatic function will be completed with two "bip" sounds. If the automatic focusing is not accomplished, a beep will be heard.

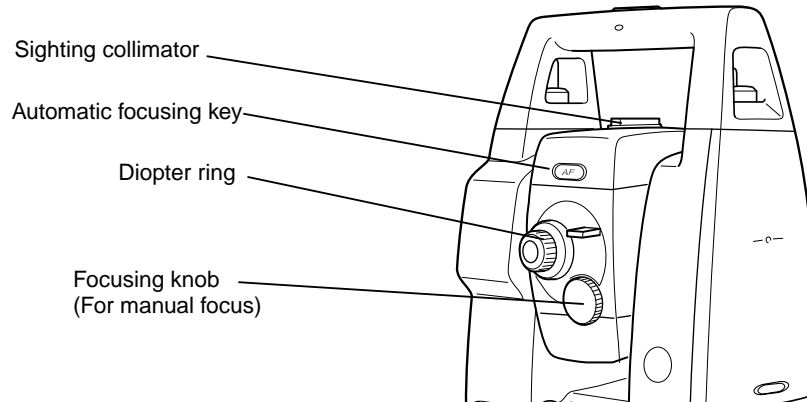

Note:

- 1) The focusing knob will turn automatically when the instrument is powered on or the automatic focusing is working.
Do not touch the knob while it turns.
- 2) EDM, the reticle illumination and the point guide are turned off automatically while the automatic focusing is working.
- 3) The auto focusing may be completed roughly when the contrast with the target and its circumference is low. In this case, focus the target manually by turning the focusing knob.
- 4) If there is an object that has higher contrast than a prism or a target near the horizontal hair line in the field of view, the instrument may focus to that object.
- 5) If a strong light comes into the eyepiece, the auto focusing may not be completed.
- 6) Before operating, the diopter adjustment should be done by turning the diopter ring so that the cross hairs are clearly observed.
- 7) If parallax is created between the cross hairs and the target, focusing is incorrect. This adversely affects precision in surveying. Eliminate the parallax by turning the focusing knob or using the diopter adjustment.
- 8) The automatic focusing adjustment can be set up by software.
See next section to adjust the focus.

1 NOMENCLATURE AND FUNCTIONS

Adjustment of automatic focusing

If the automatic focusing is incorrect though the diopter adjustment is complete, adjust the automatic focusing.

The automatic focus position adjustment can be easily set up by software as follows.

Operating procedure	Option	Display
<p>1 Press the [F5](Adj) key from the main menu icons.</p>	[F5]	 <p>Prog Std Mem Com Adj Para</p> <hr/> <p><u>Adjustment</u></p> <p>F1 V0/Axis (Measurement)</p> <p>F2 V0/Axis (Constant list)</p> <p>F3 Date Time</p> <p>F4 Auto Focus ↓</p>
<p>2 Press the [F4](Auto Focus) key.</p>	[F4]	<p>Adj. Auto Focus (1/2)</p> <p>Adjust diopter.</p> <p>And press [AF] key.</p> <p>EXIT AF</p>
<p>3 Adjustment the diopter by turning the diopter ring so that the cross hairs are clearly observed.</p>	Adjust diopter	
<p>4 Press the [F6](AF) key. Auto focusing will start.</p>	[F6]	<p>Adj. Auto Focus (2/2)</p> <p>Focus with the manual knob</p> <p>if out of focus.</p> <p>Then press [SET] key</p>
<p>5 Look into the telescope and confirm whether the focusing is completely done or not. If not, focus the target with the focusing knob manually.</p>	Focus manually	<p>EXIT BACK SET</p>
<p>6 Press the [F6](SET) key to finish the adjustment. The screen will return to the main menu icons.</p>	[F6]	
<p>● Press the [F2](BACK) key to return to previous screen (Step three).</p>		

2 PREPARATION FOR MEASUREMENT

2.1 Power Connection

(unnecessary if on-board Ni-MH battery BT-50Q is used)

See below for connecting the external battery pack.

- **Battery pack BT-3Q**
Power cord , PC-5 is used.
- **Large capacity battery pack BT-3L**
Power cord PC-6 is used.

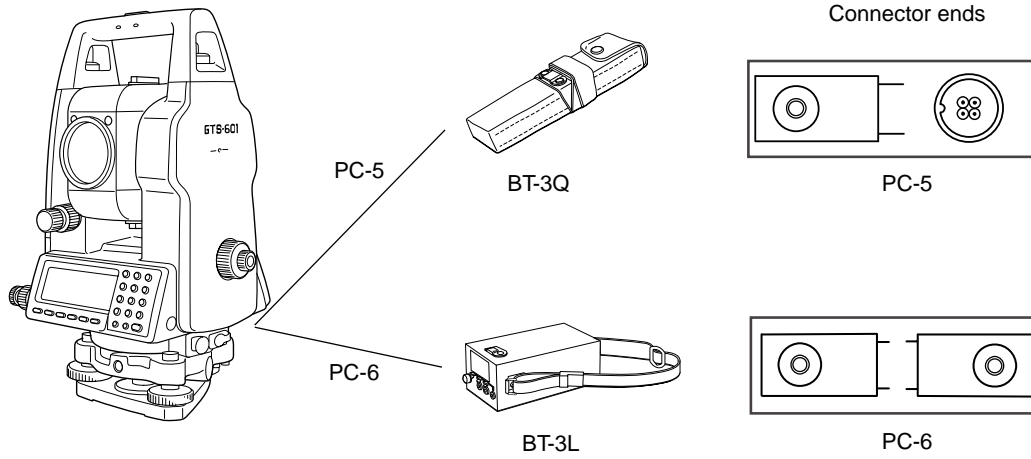

2.2 Setting Instrument Up For Measurement

Mount the instrument to the tripod. Level and center the instrument precisely to insure the best performance. Use tripods with a tripod screw of 5/8 in. diameter and 11 threads per inch, such as the Type E TOPCON wide- frame wooden tripod.

Reference: Leveling and Centering the Instrument

1. Setting up the Tripod

First, extend the extension legs to suitable lengths and tighten the screws on their midsections.

2. Attaching the Instrument on the Tripod Head

Place the instrument carefully on the tripod head and slide the instrument by loosening the tripod screw. If the plumb bob is positioned right over the center of the point, slightly tighten the tripod screw.

3. Roughly Leveling the Instrument by Using the Circular Level

- 1 Turn the leveling screws A and B to move the bubble in the circular level. The bubble is now located on a line perpendicular to a line running through the centers of the two leveling screws being adjusted.

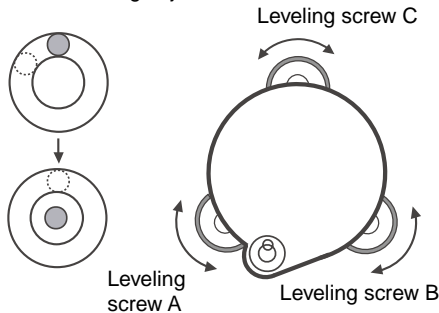

- 2 Turn the leveling screw C to bring the bubble to the center of the circular level.

4. Centering by Using the Plate Level

- 1 Rotate the instrument horizontally by using the Horizontal motion/clamp screw and place the plate level parallel with the line connecting leveling screws A and B, and then bring the bubble to the center of the plate level by turning leveling screws A and B.

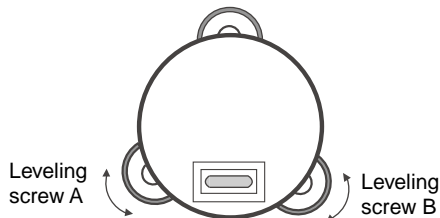

- 2 Rotate the instrument 90° (100g) around its vertical axis and turn the remaining leveling screw or C to center the bubble once more.

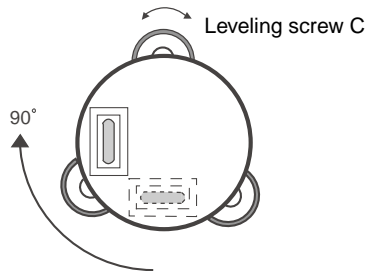

- 3 Repeat the procedures 1 and 2 for each 90° (100g) rotation of the instrument and check whether the bubble is correctly centered for all four points.

5. Centering by Using the Optical Plummet Telescope

Adjust the eyepiece of the optical plummet telescope to your eyesight. Slide the instrument by loosening the tripod screw, place the point on the center mark, and then tighten the tripod screw. Sliding the instrument carefully not to rotate that allows you to get the least dislocation of the bubble.

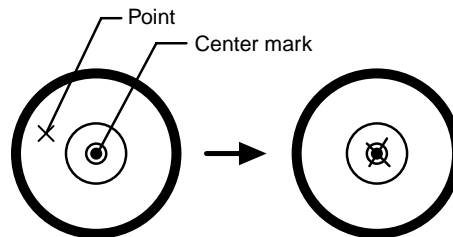

6. Completely Leveling the Instrument

Leveling the instrument precisely in a similar way to 4. Rotate the instrument and check to see that the bubble is in the center of the plate level regardless of telescope direction, then tighten the tripod screw hard.

2.3 Power Switch Key ON

- 1 Confirm the instrument is leveled.
- 2 Turn the power switch ON.

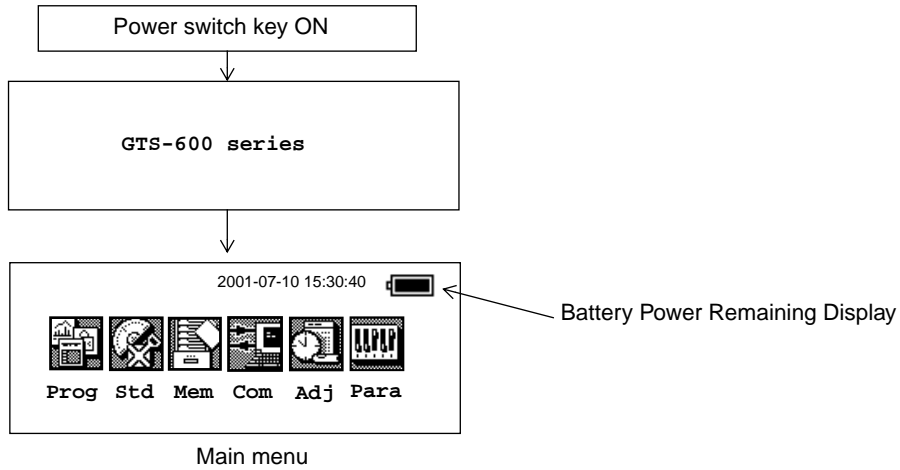

- Confirm the battery power remaining on the display. Replace with charged battery or charge when battery level is low. see Section 2.4 "Battery Power Remaining Display" .

2.4 Battery Power Remaining Display

Battery power remaining display indicates the power condition.

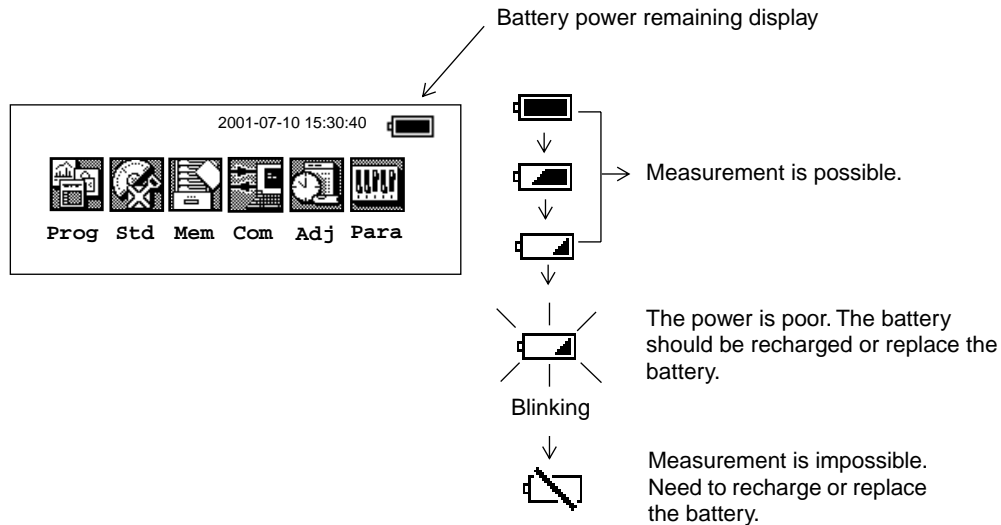

* Battery power remaining display is omitted in this manual.

Note:

- 1) The battery operating time will vary depending on the environmental conditions such as ambient temperature, charging time, the number of times of charging and discharging etc. It is recommended for safety to charge the battery beforehand or to prepare spare full charged batteries.
- 2) For general usage of the battery, see Chapter 12 POWER SOURCE AND CHARGING .
- 3) The battery power remaining display shows the power level regarding to the measurement mode now operating.
The safety condition indicated by the battery power remaining display in the angle measurement mode does not necessarily assure the battery's ability to be used in the distance measurement mode.
It may happen that the mode change from the angle mode to the distance mode will stop the operation because of insufficient battery power for the distance mode which consumes more power than angle mode.
Note that the EDM unit is working when the pictogram for zero set and the battery power remaining display shown at the power ON, which shows as an easy battery check before use
- 4) When the measurement mode is changed, it rarely may happen that the Battery Power Remaining Display will decrease or increase two steps momentarily because of the accuracy of the battery checking system is rough. It is not trouble with the instrument.

2.5 Main Menu Contains

The main menu contains as following items.
Select the menu by pressing soft keys ([F1]~[F6]).

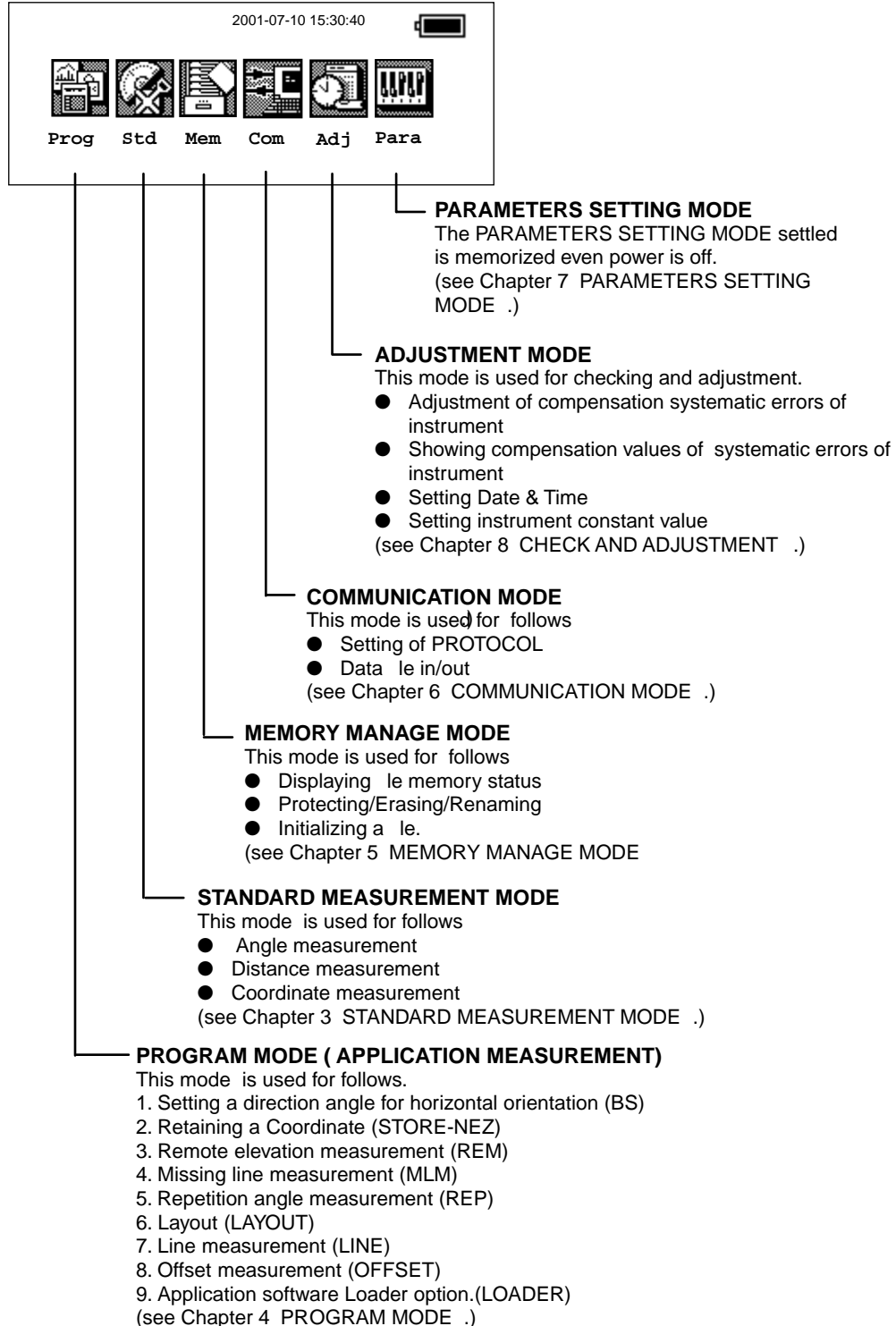

2.6 Vertical and Horizontal Angle Tilt Correction

When the tilt sensors are activated, automatic correction of vertical and horizontal angle for mislevelment is displayed.

To ensure a precise angle measurement, tilt sensors must be turned on. The display can also be used to fine level the instrument. If the (TILT OVER) display appears the instrument is out of automatic compensation range and must be leveled manually.

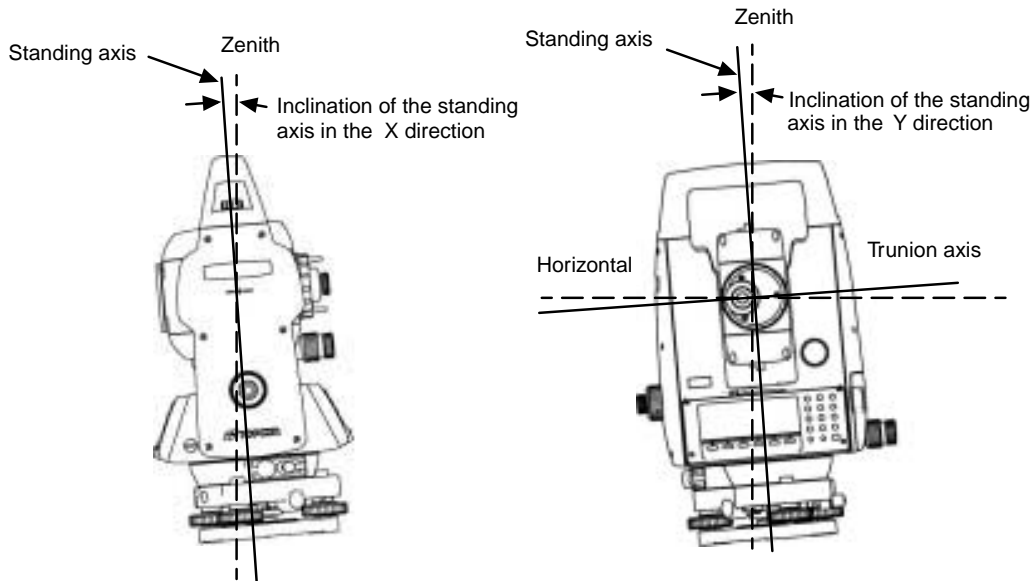

- GTS-600 compensates both the vertical angle and the horizontal angle readings due to inclination of the standing axis in the X and Y directions .
- For more information about dual axis compensation, see Chapter "APPENDIX" .

When the instrument tilted over correction range.

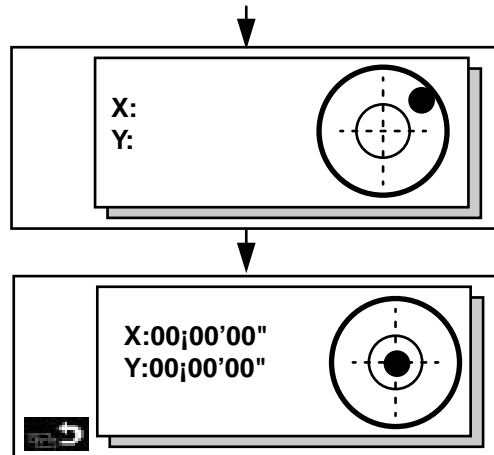

Rotate the leveling screws and level the instrument.
After leveling, the display returns to the previous mode.

- The display of Vertical or Horizontal angle is unstable when instrument is on an unstable stage or a windy day. You can turn off the auto tilt correction function of V/H angle in this case. To set TILT correction mode ON/OFF, refer to next page or Chapter 7 "PARAMETERS SETTING MODE" .

2 PREPARATION FOR MEASUREMENT

- **Setting Tilt Correction by Soft Key**

Enable you to select tilt ON/OFF function on page 2.

The setting performed here will be memorized after powering OFF.

[Example] Setting X,Y Tilt ON

Operating procedure	Option	Display
1 Press [F6] key to get the function page 2.		
2 Press [F5](TILT) key. Current setting is displayed. *1	[F6] [F5]	
3 Press [F2](ON-2) key. The display shows tilt correction value.	[F2]	
4 Press [F1] key. The display returns previous mode.	[F1]	
<p>*1) Pressing [F6](ESC) key, the display returns previous mode.</p> <ul style="list-style-type: none"> ● The setting performed here will be interlocked with setting in Chapter 7 PARAMETERS SETTING MODE 		

2.7 Compensation of Systematic Error of Instrument

- 1) Error of vertical axis (X,Y tilt sensor offset)
- 2) Collimation error
- 3) Error of vertical angle 0 datum
- 4) Error of horizontal axis

The above mentioned errors can be compensated by software, which calculated internally according to each compensation value.

Also these errors can be compensated by software collimating one side of the telescope that is carried out to delete the error by turning in normal and reverse both sides of telescope so far.

- To adjust or reset the above compensation value, see Chapter 8 "CHECK AND ADJUSTMENT" .
- Enable you to stop this function, see Chapter 7 "PARAMETERS SETTING MODE" or Chapter 8 "CHECK AND ADJUSTMENT" .

2.8 Resume Mode ON/OFF

(Memorizing the measurement mode when power is off.)

The Resume Mode will memorize the last display or mode when the power is turned OFF. When the power is turned back ON, the last display or mode will be shown . This option saves time and keystrokes in the field.

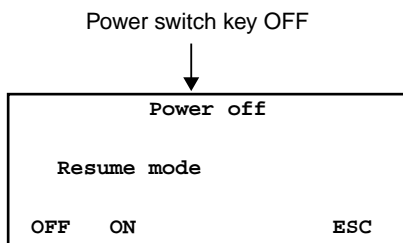

[F1] [F2] Pressing [F1](OFF) key or [F2](ON) key, select the resume mode.

Note:

If [F2](ON) key is selected, the instrument must be leveled before power is ON. If it is not leveled, the tilt over display will appear. In this case, rotate the leveling screw and level the instrument.

2.9 How to Enter Numerals and Alphabet Letters

This enables you to enter numerals or alphabet letters such as the file name.

[Example] Enter "HIL 104" to rename the file name.

Operating procedure	Option	Display
1 Press [F1](Alpha) key to be entering alphabet letter mode. 2 Enter Alphabets. *1) Input "H" Move cursor Input "I" Input "L" Input "_"	[F1]	Rename Old name [TOPCON .DAT] New name [_] <hr/> Alpha SPC ← →
	[9][9] [F4] [9][9][9] [4][4][4] [3][3][3]	Rename Old name [TOPCON .DAT] New name [HIL_] <hr/> Num SPC ← →
3 Press [F1](Num) key to be entering numeric mode. Input "104"	[F1] [1][0][4]	Rename Old name [TOPCON .DAT] New name [HIL_104_] <hr/> Alpha SPC ← →
4 Press [ENT] key.	[ENT]	
*1)When entering a alphabet in the same key consecutively, press [F4](→) key to move the cursor to the right then enter the alphabet key.		

2.10 Data Memory Card (Only for Card model)

- How to insert a data memory card

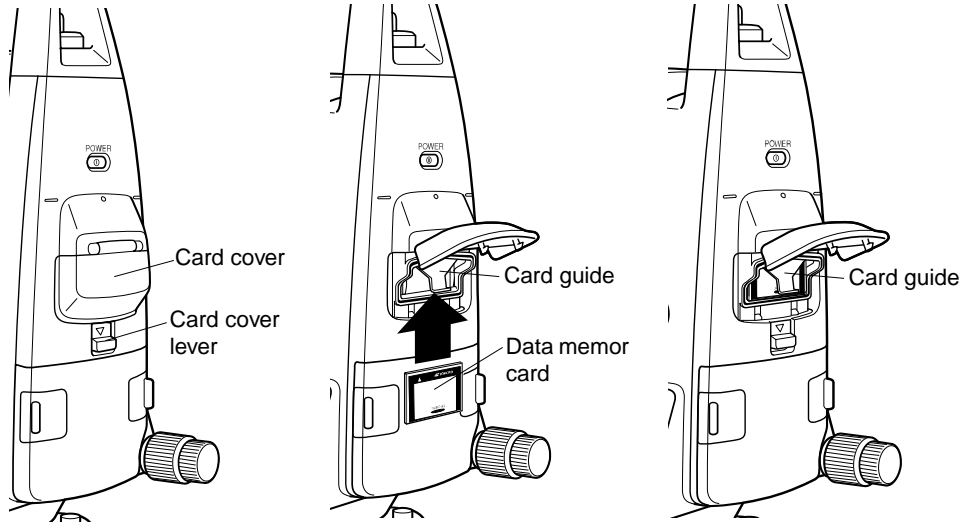

- 1 Pull the card cover lever to open the card cover.
- 2 Insert a memory card until the card guide is up.
Make sure the card is inserted firmly in the correct direction.
- 3 Close the card cover.

- How to extract a memory card

- 1 Pull the card cover lever to open the card cover.
- 2 Pull down the card guide.
Note: Hold the card with your hand to protect the card against falling.
- 3 Extract the memory card.
- 4 Close the card cover.

3 STANDARD MEASUREMENT MODE

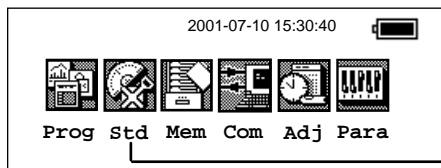

[Press [F2] key.]

STANDARD MEASUREMENT MODE
Angle measurement, Distance measurement, Coordinate measurement .

3.1 Angle Measurement

3.1.1 Measuring Horizontal Angle Right and Vertical Angle

Make sure the mode is in Angle measurement.

Operating procedure	Operation	Display
1 Collimate the 1st target (A).	Collimate A	V : 87°55'45" HR: 180°44'12" SD HD NEZ OSET HOLD P1 ↓
2 Set horizontal angle of target A at 0 00' 00". Press [F4](0 set)key and [F6](SET) key.	[F4]	H-OSET HR: 00°00'00" ESC SET
	[F6]	V : 87°55'45" HR: 00°00'00" SD HD NEZ OSET HOLD P1 ↓
3 Collimate the 2nd target (B). The required H/V angle to target B will be displayed.	Collimate B	V : 87°55'45" HR: 123°45'50" SD HD NEZ OSET HOLD P1 ↓

Reference : How to Collimate

- 1 Point the telescope toward the light. Turn the diopter ring and adjust the diopter so that the cross hairs are clearly observed.
(Turn the diopter ring toward you first and then backward to focus.)
- 2 Aim the target at the peak of the triangle mark of the sighting collimator. Allow a certain space between the sighting collimator and yourself for collimating.
- 3 Focus the target with the focusing knob.

*If parallax is created between the cross hairs and the target when viewing vertically or horizontally while looking into the telescope, focusing is incorrect or diopter adjustment is poor. This adversely affects precision in measurement or survey. Eliminate the parallax by carefully focusing and using diopter adjustment.

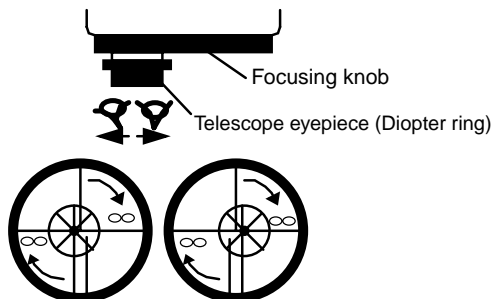

3 STANDARD MEASUREMENT MODE

3.1.2 Switching Horizontal Angle Right/Left

Make sure the mode is Angle measurement.

Operating procedure	Operation	Display
1 Press [F6](↓)key to get the function as on page 2.		<div style="border: 1px solid black; padding: 5px;"> V : 87°55'45" HR: 120°30'40" SD HD NEZ OSET HOLD P1 ↓ REC HSET R/L V/% TILT P2 ↓ </div>
2 Press [F3](R/L) key. The mode Horizontal angle Right (HR) switches to (HL) mode.	[F3]	<div style="border: 1px solid black; padding: 5px;"> V : 87°55'45" HL: 239°29'15" REC HSET R/L V/% TILT P2 ↓ </div>
3 Measure the target in the same manner as HR mode.		
<ul style="list-style-type: none"> ● Every time pressing [F3](R/L) key is pressed, HR/HL mode switches. <p>Note: It is possible that the R/L switching is prohibited (R/L Rock). To set the R/L rock, see Chapter 7 PARAMETERS SETTING MODE .</p>		

3.1.3 Measuring from the Required Horizontal Angle

1) Setting by Holding the Angle

Make sure the mode is angle measurement..

Operating procedure	Operation	Display
1 Set the required horizontal angle, using Horizontal tangent screw	Display angle	<div style="border: 1px solid black; padding: 5px;"> V : 90°10'20" HR: 70°20'30" SD HD NEZ OSET HOLD P1 ↓ </div>
2 Press [F5](HOLD) key.	[F5]	<div style="border: 1px solid black; padding: 5px;"> Holding HR: 70°20'30" ESC REL </div>
3 Collimate the target.*1)	Collimate	
4 Press [F6](REL) key to finish holding the horizontal angle. The display turns back to normal angle measurement mode.	[F6]	<div style="border: 1px solid black; padding: 5px;"> V : 90°10'20" HR: 70°20'30" SD HD NEZ OSET HOLD P1 ↓ </div>
<p>*1)To return to the previous mode, press [F1](ESC) key.</p>		

3 STANDARD MEASUREMENT MODE

2) Setting a Horizontal Angle from the Keys

Make sure the mode is Angle measurement.

Operating procedure	Operation	Display
1 Collimate the target.	Collimate	V : 90°10'20" HR: 120°30'40"
2 Press [F6](↓) key to get the function as on page 2, and press [F2](HSET) key.	[F6]	SD HD NEZ OSET HOLD P1 ↓ REC HSET R/L V/% TILT P2 ↓
3 Input the required horizontal angle. *1) For example:70°20'30"	[F2] Input value	H-SET HR:_ H-SET HR:70.203 EXIT BS
4 Press [ENT] key. *2) When completed, normal measuring from the required Horizontal angle is possible.	[ENT]	V : 90°10'20" HR: 70°20'30" SD HD NEZ OSET HOLD P1 ↓
*1)To revise wrong value, move cursor with [F6](BS) key, or input from the beginning by [F1](EXIT) key to correct value. *2)With wrong input value(for example 70'), setting will not be completed. Input again from step 3 .		

3.1.4 Vertical Angle Percent Grade(%) Mode

Make sure the mode is Angle measurement.

Operating procedure	Operation	Display
1 Press [F6](↓) key to get the function as on page 2.	[F6]	V : 90°10'20" HR: 120°30'40" SD HD NEZ OSET HOLD P1 ↓ REC HSET R/L V/% TILT P2 ↓
2 Press [F4](V/%) key. *1)	[F4]	V%: -0.30 % HR: 120 30'40" REC HSET R/L V/% TILT P2 ↓
*1) Every time pressing the [F4](V/%) key, the display mode switches.		

3.2 Distance Measurement

3.2.1 Setting of the Atmospheric Correction

When setting the atmospheric correction, obtain the correction value by measuring the temperature and pressure.

Setting the atmospheric correction is in the STAR key (***) mode, see Chapter 10 "SETTING ATMOSPHERIC CORRECTION" .

3.2.2 Setting of the Correction for Prism Constant

Topcon's prism constant value is 0. Set correction for prism at 0. If the prism is of another manufacture, the appropriate constant shall be set beforehand.

Setting the prism constant value is in the STAR key (***) mode, see Chapter 9 "SETTING THE PRISM CONSTANT VALUE" .

3.2.3 Distance Measurement (Continuous Measurement)

Make sure the mode displays angle measurement.

Operating procedure	Operation	Display
<p>1 Collimate the center of prism.</p>		<pre>V : 90°10'20" HR: 120°30'40" SD HD NEZ OSET HOLD P1↓</pre>
<p>2 Press [F1](SD) key or [F2](HD)key. *1), 2) [Example] Horizontal distance mode</p>	[F2]	<pre>V : 90°10'20" HR: 120°30'40" PSM 0.0 HD: < PPM 0.0 VD: (m) *F.R MEAS MODE VH SD NEZ P1↓</pre> <p style="text-align: center;">↓</p>
<p>The result are shown*3) ~ *6)</p>		<pre>V : 90°10'20" HR: 120°30'40" PSM 0.0 HD: 716.661 PPM 0.0 VD: 4.001 (m) *F.R MEAS MODE VH SD NEZ P1↓</pre>
<p>*1)The following characters will be shown on the 4th line right hand corner of the display to represent measurement mode. F=Fine; C=Coarse; T=Tracking; R=Continuous (Repeat); S=Single; N=N time</p> <p>*2)When EDM is working, the " *" mark appears in the display.</p> <p>*3)The result is shown with buzzer sound.</p> <p>*4)Measurement may repeat automatically if the result is affected by shimmer etc..</p> <p>*5)To change single measuring, press [F1](MEAS) key.</p> <p>*6)To return to the angle measurement mode, press [F3](VH) key.</p>		

3 STANDARD MEASUREMENT MODE

3.2.4 Distance Measurement (Single/N-times Measurement)

When presetting the number of times, the instrument measures the distance as the setting times and the average distance will be displayed.

When presetting the number of times as 1, it does not display the average distance, because of single measurement. It has been set at single measurement at factory.

1) Setting the number of times

Confirm the angle measurement mode.

Operating procedure	Operation	Display
1 Press [F1](SD) or [F2](HD) key. 2 Press [F6](↓) key to get the function page as 2. 3 Press [F3](MEAN) key. 4 Input the setting the number of times, and press [ENT] key. *1) [Example] 4 times N-times measurement starts.		V : 90°10'20" HR: 120°30'40" SD HD NEZ OSET HOLD P1 ↓
	[F2]	V : 90°10'20" HR: 120°30'40" PSM 0.0 HD: PPM 0.0 VD: (m) F.R MEAS MODE VH SD NEZ P1 ↓ REC SO MEAN m/ft P2 ↓
	[F6]	Average times N:0 EXIT BS ↓
	[F3]	V : 90°10'20" HR: 120°30'40" PSM 0.0 HD: < PPM 0.0 VD: (m) *F.N REC SO MEAN m/ft P2 ↓
	[F4][ENT]	

2) Measuring Method

Confirm the angle measurement mode.

Operating procedure	Operation	Display
1 Collimate the center of the prism. 2 Select the measurement mode by pressing [F1](SD) or [F2](HD) key. Example:Horizontal distance N-times measurement starts.	Collimate	V : 90°10'20" HR: 120°30'40" SD HD NEZ OSET HOLD P1 ↓
	[F2]	V : 90°10'20" HR: 120°30'40" PSM 0.0 HD: PPM 0.0 VD: (m) F.N MEAS MODE VH SD NEZ P1 ↓

3 STANDARD MEASUREMENT MODE

The average value is displayed following with buzzer sound and “*” mark disappears.

↓

V :	90°10'20"				
HR:	120°30'40"	PSM	0.0		
HD:	54.321	PPM	0.0		
VD:	1.234	(m)	*F.N		
MEAS	MODE	VH	SD	NEZ	P1 ↓

↓

V :	90°10'20"				
HR:	120°30'40"	PSM	0.0		
HD:	54.321	PPM	0.0		
VD:	1.234	(m)	F.N		
MEAS	MODE	VH	SD	NEZ	P1 ↓

- Press [F1](MEAS) key for re-measuring after the measurement in held.
- To return to the continuous measuring , press [F1](MEAS) key twice.
- To return to the angle measuring mode , press [F3](VH) key.

3 STANDARD MEASUREMENT MODE

3.2.5 Fine/ Tracking / Coarse Measuring Mode

- Fine mode : This is a normal distance measuring mode.
 Measurement time 0.2mm mode : approx.2.8 seconds
 1 mm mode : approx.1.2 seconds
 The unit to be displayed is 0.2mm or 1mm. (0.001ft or 0.005ft)

- Tracking mode : This mode measures in shorter time than in fine mode.
 Use this mode for stake out measurement. It is very useful when tailing the moving object or carrying out stake-out work.
 Measurement time : approx. 0.4 seconds
 The unit to be displayed is 10mm. (0.02ft)

- Coarse mode : This mode measures in shorter time than in fine mode.
 Use this mode for the objects which may be slightly unstable.
 Measurement time : approx. 0.7 seconds
 The unit to be displayed is 1mm. (0.005ft)

Operating procedure	Operation	Display
1 Collimate the center of prism.	Collimate	<pre>V : 90°10'20" HR: 120°30'40" SD HD NEZ OSET HOLD P1 ↓</pre>
2 Select the measurement mode by pressing [F1](SD) or [F2](HD) key. Example:Horizontal distance Measuring starts.	[F2]	<pre>V : 90°10'20" HR: 120°30'40" PSM 0.0 HD: < PPM 0.0 VD: (m) *F.R MEAS MODE VH SD NEZ P1 ↓</pre>
3 Press [F2](MODE) key , the mode changes to Coarse mode. Press [F2](MODE) key again, the mode changes to Tracking mode. *1)	[F2] [F2]	<pre>V : 90°10'20" HR: 120°30'40" PSM 0.0 HD: PPM 0.0 VD: (m) T.R MEAS MODE VH SD NEZ P1 ↓</pre>
*1) Every time pressing [F2](MODE) key, the mode will be changed in procedure 3 .		

3 STANDARD MEASUREMENT MODE

3.2.6 Stake Out (S-O)

The difference between the measured distance and the distance preset is displayed.

The displayed value = Measured distance - Standard (Preset) distance

- Stake out operation can be performed for horizontal distance (HD), relative elevation (VD) or slope distance (SD)

[Example: Relative elevation]

Operating procedure	Operation	Display
<p>1 Press [F6](P1) key in the distance measuring mode to get the function as in page 2.</p>	[F6]	<pre>V : 90°10'20" HR : 120°30'40" PSM 0.0 HD : PPM 0.0 VD : (m) F.R MEAS MODE VH SD NEZ P1 ↓ REC SO MEAN m/ft P2 ↓</pre>
<p>2 Press [F2](S-O) key and press [ENT] key.</p>	[F2] [ENT]	<pre>SO HD : 0.000 VD : _ EXIT BS</pre>
<p>3 Enter the relative elevation for stake out, and press [ENT] key. The measuring starts.</p>	Enter value [ENT]	<pre>V : 90°10'20" HR : 120°30'40" PSM 0.0 HD : < PPM 0.0 dVD : (m) *F.R REC SO MEAN m/ft P2 ↓</pre>
<p>4 Collimate the target (Prism).</p> <p>The difference between the measured distance and the standard distance is displayed.</p>		<p style="text-align: center;">↓</p> <pre>V : 90°10'20" HR : 120°30'40" PSM 0.0 HD : < PPM 0.0 VD : (m) *F.N REC SO MEAN m/ft P2 ↓</pre>
<p>● To return to normal distance measurement mode, reset the standard distance to 0 or turn the power switch off (Resume mode:OFF) once.</p>		

3.3 COORDINATE MEASUREMENT

3.3.1 Setting Coordinate Values of Occupied Point

Set the coordinates of instrument (occupied point) according to coordinate origin, and the instrument automatically converts and displays the unknown point (prism point) coordinates following the origine. It is possible to retain the coordinates of the occupied point after turning the power off (Resume mode :OFF). Refer to Chapter 7 "PARAMETERS SETTING MODE".

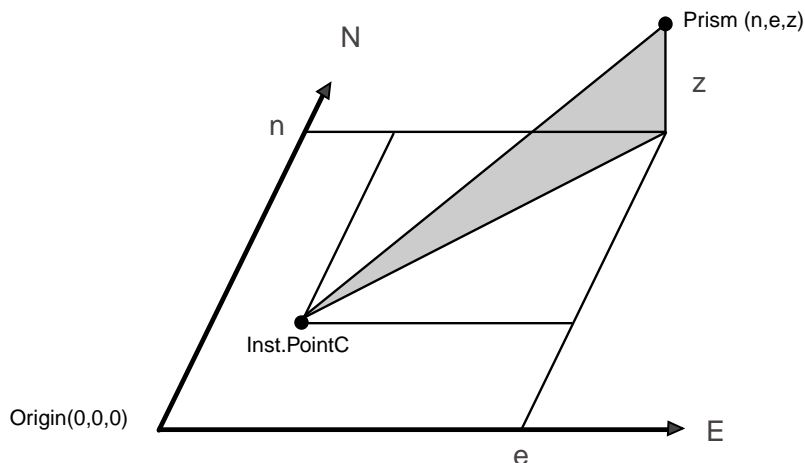

Confirm the angle measurement mode.

Operating procedure	Operation	Display
1 Press [F3](NEZ) key.	[F3]	<pre>V : 90°10'20" HR: 120°30'40" SD HD NEZ OSET HOLD P1 ↓</pre>
2 press [F6](↓) key to get the function as on page 2.	[F6]	<pre>N : < E : PSM 0.0 Z : PPM 0.0 (m) *F.R MEAS MODE VH SD HD P1 ↓ REC HT MEAN m/ft SET P2 ↓</pre>
3 Press [F5](SET) key. The previous data will be shown.	[F5]	<pre>Setting occ. point N : 12345.6700 E : 12.3400 Z : 10.2300 EXIT BS</pre>

3 STANDARD MEASUREMENT MODE

4 Input new data and press [ENT] key.*1)

Measuring starts.

N coord.
[ENT]
E coord.
[ENT]
Z coord.
[ENT]

Setting occ. point	
N :	0.0000
E :	0.0000
Z :	0.0000
EXIT	BS

Complete

↓

N :	<		
E :		PSM	0.0
Z :		PPM	0.0
		(m)	*F.R
REC	HT	MEAN	m/ft SET P2 ↓

*1)To cancel the setting, press [F1](EXIT) key.

3.3.2 Setting of the Instrument Height / Prism Height

Measure the coordinates by entering the instrument height / prism height, coordinates of unknown point will be measured directly.
Confirm the angle measurement mode.

Operating procedure	Operation	Display
<p>1 Press [F3](NEZ) key.</p> <p>2 Press [F6](↓) key from the coordinate measurement mode to get the function as in page 2.</p> <p>3 Press [F2](HT) key. Previous data will be shown.</p> <p>4 Input instrument height, and press [ENT] key.*1)</p> <p>5 Input prism height, and press [ENT] key.</p> <p>The display returns to coordinate measuring mode.</p>	<p>[F3]</p> <p>[F6]</p> <p>[F2]</p> <p>Inst. HT [ENT]</p> <p>Prism HT [ENT]</p>	<div style="border: 1px solid black; padding: 5px; margin-bottom: 5px;"> <p>V : 90°10'20"</p> <p>HR: 120°30'40"</p> <p>SD HD NEZ OSET HOLD P1 ↓</p> </div> <div style="border: 1px solid black; padding: 5px; margin-bottom: 5px;"> <p>N :</p> <p>E : PSM 0.0</p> <p>Z : PPM 0.0</p> <p style="text-align: right;">(m) *F.R</p> <p>MEAS MODE VH SD HD P1 ↓</p> <p>REC HT MEAN m/ft SET P2 ↓</p> </div> <div style="border: 1px solid black; padding: 5px; margin-bottom: 5px;"> <p>Inst. Ht : 1.230 m</p> <p>R. Ht : 1.340 m</p> <p>EXIT BS</p> </div> <div style="border: 1px solid black; padding: 5px;"> <p>N :</p> <p>E : PSM 0.0</p> <p>Z : PPM 0.0</p> <p style="text-align: right;">(m) *F.R</p> <p>REC HT MEAN m/ft SET P2 ↓</p> </div>
<p>*1)To cancel the setting, press [F1](EXIT) key.</p>		

3 STANDARD MEASUREMENT MODE

3.3.3 Execution of Coordinate Measuring

Measure the coordinates by entering the instrument height and prism height, coordinates of unknown point will be measured directly.

- When setting coordinate values of occupied point, see Section 3.3.1“Setting Coordinate Values of Occupied Point” .
- When setting the instrument height and prism height, see Section 3.3.2“Setting of the Instrument Height / Prism Height” .
- The coordinates of the unknown point are calculated as shown below and displayed:

Coordinates of occupied point : (N_0, E_0, Z_0)
 Instrument height : Inst.h
 Prism height : R.h
 Vertical distance(Relative elevation) : z
 Coordinates of the center of the prism,
 originated from the center point of the instrument : (n, e, z)
 Coordinates of unknown point : (N_1, E_1, Z_1)
 $N_1 = N_0 + n$
 $E_1 = E_0 + e$
 $Z_1 = Z_0 + \text{Inst.h} + z - \text{P.h}$

Coordinates of the center of the prism, originated from the center point of the instrument (n, e, z)

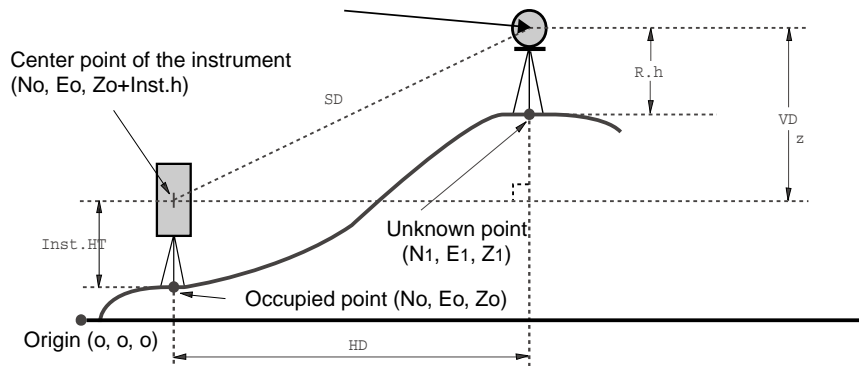

Confirm the angle measurement mode.

Operating procedure	Operation	Display
<ol style="list-style-type: none"> 1 Set coordinates values of occupied point and instrument/prism height. *1) 2 Set the direction angle of known point A. *2) 	Set direction angle	<pre> V : 90°10'20" HR: 120°30'40" SD HD NEZ OSET HOLD P1 ↓ </pre>
<ol style="list-style-type: none"> 3 Collimate target B. 4 Press [F3](NEZ) key.*3) Measuring starts. 	Collimate [F3]	<pre> N : < E : PSM 0.0 Z : PPM 0.0 (m) *F.R MEAS MODE VH SD HD P1 ↓ </pre>

3 STANDARD MEASUREMENT MODE

The result will be shown.

↓

N	: 12345.6789				
E	: -12345.6789	PSM	0.0		
Z	: 10.1234	PPM	0.0		
		(m)	*F.R		
MEAS	MODE	VH	SD	HD	P2 ↓

- *1) In case the coordinate of instrument point is not entered, (0,0,0) will be used as the default for the instrument point.
The instrument height will be calculated as 0 when the instrument height is not entered.
The prism height will be calculated as 0 when the prism height is not set.
- *2) Refer to Section 3.1.3 Measuring from the Required Horizontal Angle or Section 4.1 Setting a Direction Angle for Backsight Orientation .
- *3) Pressing [F1](MEAS) key, the measurement mode (Continuous measuring/ N-time measuring) changes.
Pressing [F2](MODE) key, the measurement mode (FINE/ COARSE/TRACKING) changes.
- To return to the normal angle or distance measuring mode, press [F6](P↓) key to return to the function as on page 1 and press [F3](VH),[F4](SD) or [F5](HD) key.

3 STANDARD MEASUREMENT MODE

3.4 DATA OUTPUT

Result of measurement is transferred from the GTS-600 series to Data Collector.

[Example: Distance measurement mode]
Confirm the distance measurement mode.

Operating procedure	Display
<p>1 Operate the data collector to measure the distance. Measurement will be started.</p>	<pre>V: 90°10'20" HR: 120°30'40" PSM 0.0 HD: < PPM 0.0 VD: (m) *F.R MEAS MODE VH SD NEZ P1 ↓</pre>
<p>2 The result will be shown and transferred to the Data Collector.</p>	<pre>V : 90°10'20" HR: 120°30'40" PSM 0.0 HD: 10.1234 PPM 0.0 VD: 1.234 (m) *F.R REC > > ></pre>
<p>3 The mode will automatically return to the distance measurement mode.</p>	<pre>V : 90°10'20" HR: 120°30'40" PSM 0.0 HD: 10.1234 PPM 0.0 VD: 1.234 (m) *F.R MEAS MODE VH SD NEZ P1 ↓</pre>

The following data will be output at each mode.

Mode	Output
Angle mode (V,HR or HL) (V in percent)	V, HR (or HL)
Horizontal distance mode (V,HR, HD, VD)	V, HR, HD, VD
Slope distance mode (V, HR,SD)	V, HR, SD,HD
Coordinate mode	N, E, Z, HR

3.5 DATA Output by soft key (REC)

It is also possible to output the result of measurement by pressing the soft key (REC).
 [Example: Slope Distance measurement mode]

Confirm the slope distance measurement mode.

Operating procedure	Operation	Display
<p>1 Press [F6](↓) key to get the function page as 2.</p>	[F6]	<pre> V : 90°10'20" HR: 120°30'40" PSM 0.0 SD: < PPM 0.0 (m) F.R MEAS MODE VH SD NEZ P1↓ REC SO MEAN m/ft P2↓ </pre>
<p>2 Press [F1](REC) key. Measuring will continue at this time.</p>	[F1]	<pre> V : 90°10'20" HR: 120°30'40" PSM 0.0 SD: < PPM 0.0 (m) F.R [YES] [NO] </pre>
<p>3 Press [F5](YES) key. The measurement will start.</p>	[F5]	<pre> V : 90°10'20" HR: 120°30'40" PSM 0.0 SD: < PPM 0.0 (m) *F.R REC SO MEAN m/ft P2↓ </pre>
<p>After the measurement, the result will be hold then recorded.</p>		<pre> V : 90°10'20" HR: 120°30'40" PSM 0.0 SD: 123.456 PPM 0.0 (m) *F.R REC > > > </pre>
<p>The screen will return to previous display.</p>		<pre> V : 90°10'20" HR: 120°30'40" PSM 0.0 SD: < PPM 0.0 (m) *F.R REC SO MEAN m/ft P2↓ </pre>

4 PROGRAM MODE

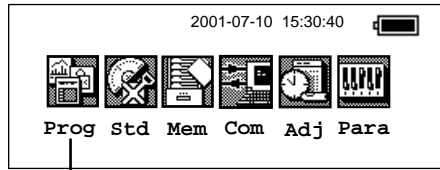

[Press [F1] key.]

PROGRAM MODE (APPLICATION MEASUREMENT)

- 1.Setting a direction angle for backsight orientation (BS)
- 2.Retaining a coordinate (STORE-NEZ)
- 3.Remote elevation measurement (REM)
- 4.Missing line measurement (MLM)
- 5.Repetition angle measurement (REP)
- 6.Layout (LAYOUT)
- 7.Line measurement mode (LINE)
8. Offset measurement (OFFSET)
- 9.Application software Loader (LOADER)

- The loaded measuring programs are added on this menu.

Programs			
F1	BS	p	4/9
F2	STORE	p	
F3	REM	p	
F4	MLM	p	MORE

↑ [F6](MORE) key ↓

Programs			
F1	REP	p	8/9
F2	LAYOUT	p	
F3	LINE	p	
F4	OFFSET	p	MORE

↑ [F6](MORE) key ↓

Programs			
F1	LOADER	p	9/9
			MORE

4.1 Setting a Direction Angle for Backsight Orientation

(Entering the instrument and backsight coordinate values)

This program uses the input coordinate values of the occupied point, (instrument), and backsight point to compute the backsight orientation direction angle.

The occupied coordinate input display appears as (BS:M-POINT). The backsight input display appears as (BS:T-POINT). After the coordinate values are entered for both points, the instrument computes the backsight direction angle for orientation. Only the occupied coordinate values are stored in memory if the option is selected to (ON) in the Parameter Modes option. See Chapter 7 "PARAMETERS SETTING MODE". The program does not store the backsight coordinate values in memory.

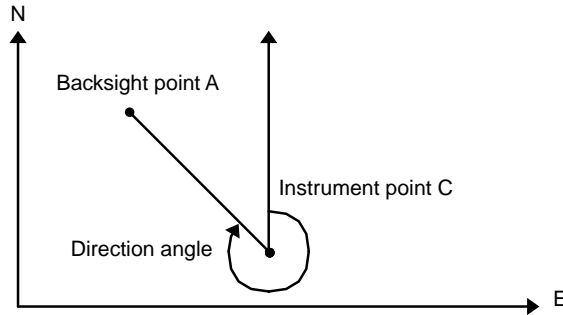

Example: Backsight point A : N coordinate 54.321m, E coordinate 12.345m

Operating procedure	Operation	Display
1 Press [F1](BS) key. Current data will be displayed. *1)	[F1]	<pre> Programs ----- F1 BS p 4/9 F2 STORE p F3 REM p F4 MLM p MORE </pre>
	2 Press [F6](OK) key. 3 Input N and E coordinate of backsight point A. Example : N coordinate;54.321m : E coordinate;12.345m	[F6]
[ENT]		<pre> Setting Direction Angle BS:T-POINT N : 54.321 m E : 12.345 m EXIT BS </pre>
[ENT]		<pre> Setting Direction Angle BS HR : 320°10'20" > Set OK? EXIT YES NO </pre>
4 Sight backsight point A. 5 Press [F5](YES) key. The display returns to main menu.		<pre> Complete </pre>
*1)If you need to change the occupied point data, press [F1](INP) key and input new data.		

4.2 Retaining a Coordinate (STORE- NEZ)

In this program the coordinates for the next point are stored in memory after the measurement is complete and accepted. This feature allows the user to occupy the next move up point and use the previous occupied point for the backsight orientation.

When occupying the next point and backsighting the original occupied point, the instrument will display the reciprocal angle for backsight orientation. If the occupied coordinates are not preset, zero (0,0,0) or the previous preset coordinates will be used for this program.

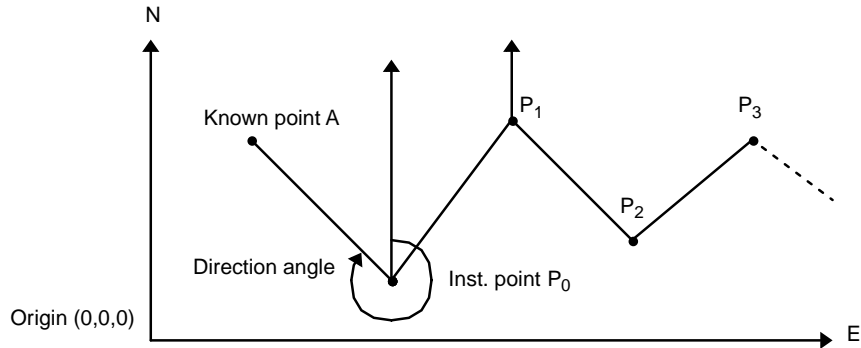

- Set the the coordinate value of instrument point P0 and set the direction angle from instrument point P0 toward known point A

Operating procedure	Operation	Display
<p>1 Press [F2](STORE) key.</p> <p>2 Press [F1](Store NEZ) key. *1)</p> <p>3 Collimate target P1 prism which the instrument moves.</p> <p>4 Press [F1](MEAS) key. Measuring will start.</p> <p>Horizontal distance and horizontal angle are shown.</p>	[F2]	<pre> Programs ----- F1 BS p 4/9 F2 STORE p F3 REM p F4 MLM p MORE </pre>
	[F1]	<pre> Retaining Coordinate 1.Store NEZ 2.Recall NEZ </pre>
	Collimate P1	<pre> Store NEZ HR : 120°30'40" HD : m MEAS HT SET </pre>
	[F1]	<pre> Store NEZ HR : 100°10'20" HD * < m MEAS SET </pre> <p style="text-align: center;">↓</p> <pre> Store NEZ HR : 100°10'20" HD * 123.456 m MEAS SET </pre>

<p>5 Press [F6](SET) key. Coordinate of P1 will be displayed.</p>	<p>[F6]</p>	<pre>Store NEZ N : 123.456 m E : 12.345 m Z : 1.234 m > SET OK? YES NO</pre>
<p>6 Press [F5](YES) key. Coordinate of P1 will be decided.</p>	<p>[F5]</p>	<pre>Complete</pre>
<p>The display return to main menu.</p> <p>Turn power off and move instrument to P1 (Prism P1 move to P0).</p>	<p>Power off</p> <p>Move to P1</p>	
<p>7 After the instrument is set up at P1, turn power on and be measurement possible.</p>	<p>Power on</p> <p>Select program</p>	<pre>Programs ----- F1 BS p 4/9 F2 STORE p F3 REM p F4 MLM p MORE</pre>
<p>8 Press [F2](STORE) key.</p>	<p>[F2]</p>	<pre>Retaining a Coordinate 1.Store NEZ 2.Recall NEZ</pre>
<p>9 Press [F2](Recall NEZ) key.</p>	<p>[F2]</p>	<pre>Recall NEZ HR: 300°10'20" > Set OK? YES NO</pre>
<p>10 Collimate P0, the former instrument point.</p>	<p>Collimate P0</p>	
<p>11 Press [F5](YES) key.</p> <p>The coordinates at P1 and direction angle toward P0 are set.</p> <p>The display return to main menu.</p>	<p>[F5]</p>	<pre>Complete</pre>
<p>12 Repeat the procedure 1 ~ 11 as much as you wish.</p>		
<p>*1)To reset the instrument height or prism height, press [F5](HT) key.</p>		

4.3 Remote Elevation measurement (REM)

The Remote Elevation program calculates the vertical distance (height) of a remote object relative to a prism and its height from a ground point, (without a prism height). When using a prism height, the remote elevation measurement will start from the prism (reference point). If no prism height is used, the remote elevation will start from any reference point in which the vertical angle is established. In both procedures, the reference point should be perpendicular to the remote object.

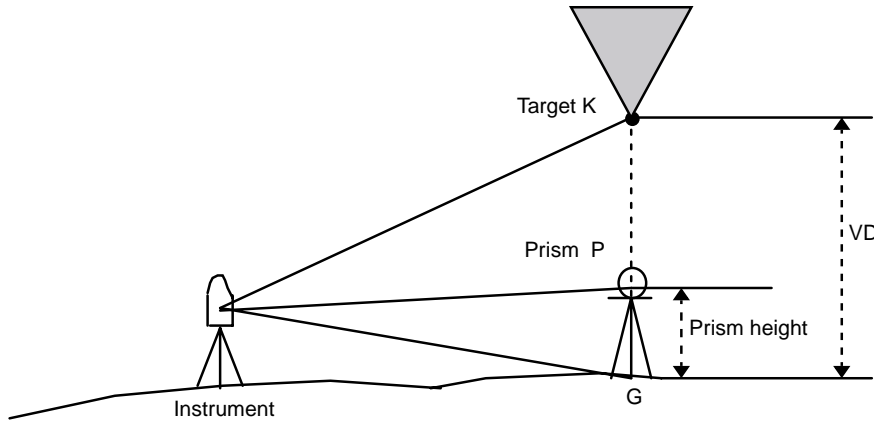

1) With prism height (h) input (Example :h=1.5m)

Operating procedure	Operation	Display
1 Press [F3](REM) key.	[F3]	<pre> Programs ----- F1 BS p 4/8 F2 STORE p F3 REM p F4 MLM p MORE </pre>
2 Press [F1](YES) key.	[F1]	<pre> REM Prism height 1.YES 2.NO </pre>
3 Enter prism height, press [ENT] key.	Enter P.HT [ENT]	<pre> REM (1)Prism Height P.h : m EXIT BS </pre>
4 Collimate prism .	Collimate P	<pre> REM (2)Horizontal Distance HD : m MEAS SET </pre>
5 Press [F1](MEAS) key. Measuring starts.	[F1]	<pre> REM (2)Horizontal Distance HD * < m MEAS SET </pre>

4 PROGRAM MODE

<p>Horizontal distance (HD) between the instrument and prism will be shown.</p> <p>6 Press [F6](SET) key. The prism position will be decided. *1)</p> <p>7 Collimate target K. Vertical distance (VD) will be shown. *2)</p>	<p>[F6]</p> <p>Collimate K</p>	<div style="border: 1px solid black; padding: 5px; margin-bottom: 5px;"> REM (2)Horizontal Distance HD : 123.456 m MEAS SET </div> <div style="border: 1px solid black; padding: 5px; margin-bottom: 5px;"> REM VD : 1.500 m EXIT P.h HD SET </div> <div style="border: 1px solid black; padding: 5px;"> REM VD : 3.456 m EXIT P.h HD </div>
<p>*1)To return to procedure 3, press [F2](P.h) key. To return to procedure 4, press [F3](HD) key. *2)To return to main menu, press [F1](EXIT) key.</p>		

2) Without prism height input.

Operating procedure	Operation	Display
<p>1 Press [F3](REM) key.</p>	<p>[F3]</p>	<div style="border: 1px solid black; padding: 5px; margin-bottom: 5px;"> Programs <hr/> F1 BS p 4/9 F2 STORE p F3 REM p F4 MLM p MORE </div> <div style="border: 1px solid black; padding: 5px;"> REM Prism height 1.YES 2.NO </div>
<p>2 Press [F2](NO) key.</p>	<p>[F2]</p>	<div style="border: 1px solid black; padding: 5px;"> REM (1)Horizontal Distance HD : m MEAS </div>
<p>3 Collimate prism.</p>	<p>Collimate P</p>	<div style="border: 1px solid black; padding: 5px; margin-bottom: 5px;"> REM (1)Horizontal Distance HD* < m MEAS SET </div> <div style="text-align: center; margin: 5px 0;"> ↓ </div> <div style="border: 1px solid black; padding: 5px;"> REM (1)Horizontal Distance HD : 123.456 m MEAS SET </div>
<p>4 Press [F1](MEAS) key. Measuring starts.</p> <p>Horizontal distance (HD) between the instrument and prism will be shown.</p>	<p>[F1]</p>	<div style="border: 1px solid black; padding: 5px;"> REM (1)Horizontal Distance HD : 123.456 m MEAS SET </div>

4 PROGRAM MODE

<p>5 Press [F6](SET) key. The prism position will be decided.</p>	[F6]	<div style="border: 1px solid black; padding: 5px;"> <p>REM (2)Vertical Angle V : 120°30'40" SET</p> </div>
<p>6 Collimate ground point G.</p>	Collimate G	<div style="border: 1px solid black; padding: 5px;"> <p>REM (2)Vertical Angle V : 95°30'40" SET</p> </div>
<p>7 Press [F6](SET) key. The position of point G will be decided. *1)</p>	[F6]	<div style="border: 1px solid black; padding: 5px;"> <p>REM VD : 0.000 m EXIT HD V</p> </div>
<p>8 Collimate target K. Vertical distance (VD) will be shown. *2)</p>	Collimate K	<div style="border: 1px solid black; padding: 5px;"> <p>REM VD : 9.876 m EXIT HD V</p> </div>
<p>*1)To return to procedure 3 , press [F2](HD) key. To return to procedure 4 , press [F3](V) key. *2)To return to main menu, press [F1](EXIT) AND [F5](YES) key.</p>		

4.4 Missing Line Measurement (MLM)

The Missing Line Measurement program calculates the horizontal distance (dHD), slope distance (dSD) and elevation (dVD) between two target prisms.

The instrument can accomplish this in two ways:

- 1.(A-B, A-C): Measurement is A-B, A-C, A-D,
- 2.(A-B, B-C): Measurement is A-B, B-C, C-D,

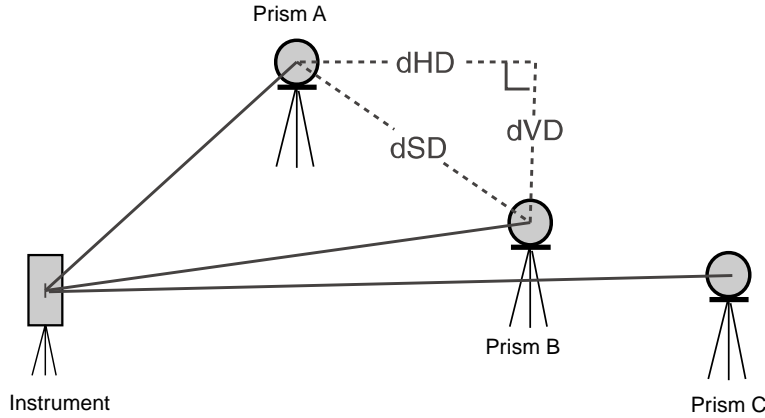

[Example] 1. (A-B, A-C)

- Procedure of 2. (A-B, B-C) mode is completely same as MLM-1 mode.

Operating procedure	Operation	Display
<p>1 Press [F4](MLM) key.</p> <p>2 Press [F1](A-B, A-C) key.</p> <p>3 Collimate prism A, and press [F1](MEAS) key.</p> <p>Horizontal distance (HD) between the instrument and prism A will be shown.</p>	[F4]	<pre> Programs ----- F1 BS p 4/9 F2 STORE p F3 REM p F4 MLM p MORE </pre>
	[F1]	<pre> Missing Line Measurement 1.(A-B, A-C) 2.(A-B, B-C) </pre>
	Collimate A [F1]	<pre> MLM 1 Horizontal Distance 1 HD : m MEAS SET </pre>
		<pre> MLM 1 Horizontal Distance 1 HD * < m MEAS SET </pre> <p style="text-align: center;">↓</p> <pre> MLM 1 Horizontal Distance 1 HD : 123.456 m MEAS SET </pre>

<p>4 Press [F6](SET) key.</p>	<p>[F6]</p>	<pre> MLM 1 Horizontal Distance 2 HD : m MEAS SET </pre>
<p>5 Collimate prism B and press [F1](MEAS) key.</p> <p>Horizontal distance (HD) between the instrument and prism B will be shown.</p>	<p>Collimate B [F1]</p>	<pre> MLM 1 Horizontal Distance 2 HD * < m MEAS SET </pre> <p style="text-align: center;">↓</p> <pre> MLM 1 Horizontal Distance 2 HD * 246.912 m MEAS SET </pre>
<p>6 Press [F6](SET) key. The horizontal distance (dHD) relative elevation (dVD) and slope distance between prism A and B.</p>	<p>[F6]</p>	<pre> MLM 1 dHD : 123.456 m dVD : 12.345 m dSD : 12.456 m EXIT HD </pre>
<p>7 To measure the distance between points A and C, press [F2](HD) key. *1)</p>	<p>[F2]</p>	<pre> MLM 1 Horizontal Distance 2 HD : m MEAS SET </pre>
<p>8 Collimate point C (Prism C) and press [F1](MEAS) key. Horizontal distance (HD) between the instrument and prism C will be shown.</p>	<p>Collimate C [F1]</p>	<pre> MLM 1 Horizontal Distance 2 HD : < m MEAS SET </pre> <p style="text-align: center;">↓</p> <pre> MLM 1 Horizontal Distance 2 HD * 246.912 m MEAS SET </pre>
<p>9 Press [F6](SET) key. The horizontal distance (dHD) relative elevation (dVD) and slope distance between prism A and C.</p>	<p>[F6]</p>	<pre> MLM 1 dHD : 123.456 m dVD : 12.345 m dSD : 12.456 m EXIT HD </pre>
<p>10 To measure the distance between points A and D, repeat procedure 7 ~9. *1)</p>		
<p>*1)To return to main menu , press[F1](EXIT) and [F5](YES) key.</p>		

4.5 Repetition Angle Measurement (REP)

Repetition Angle Measurement program accumulates horizontal angles and shows the total angle (Ht) and the mean (Hm) of all the angles measured. The program also keeps track of the amount of complete sets of horizontal angles measured.

Operating procedure	Operation	Display
1 Press [F6](MORE) key from programs menu to get to the next page of programs.	[F6]	<pre> Programs ----- F1 BS p 4/9 F2 STORE p F3 REM p F4 MLM p MORE </pre>
		<pre> Programs ----- F1 REP p 8/9 F2 LAYOUT p F3 LINE p F4 LOADER p MORE </pre>
2 Press [F1](REP) key.	[F1]	<pre> Repetition Angle CNT[0] Ht: 160°30'40" Hm: EXIT OSET REL HOLD </pre>
3 Collimate the first target A.	Collimate A	<pre> Repetition Angle CNT[0] Ht: 189°45'10" Hm: EXIT OSET REL HOLD </pre>
4 Press [F2](OSET) and [F5](YES).	[F2] [F5]	<pre> Repetition Angle CNT[0] Ht: 0°00'00" Hm: EXIT OSET REL HOLD </pre>
5 Collimate the second target B using the horizontal motion clamp and the horizontal tangent screw.	Collimate B	<pre> Repetition Angle CNT[1] Ht: 120°30'40" Hm: 120°30'40" EXIT OSET REL HOLD </pre>
6 Press [F6](HOLD) key.	[F6]	<pre> Repetition Angle CNT[1] Ht: 120°30'40" Hm: 120°30'40" EXIT OSET REL HOLD </pre>
7 Recollimate the first target A using the horizontal motion clamp and the horizontal tangent screw.	Recollimate A	<pre> Repetition Angle CNT[1] Ht: 120°30'40" Hm: 120°30'40" EXIT OSET REL HOLD </pre>
8 Press [F5](REL) key.	[F5]	<pre> EXIT OSET REL HOLD </pre>

<p>9 Recollimite the second target B using the horizontal motion clamp and the horizontal tangent screw.</p> <p>10 Press [F6](HOLD) key. The total of angle (Ht) and the average of angle (Hm) are shown.</p> <p>11 Repeat 7 to 10 to measure the desired number of repetitions.</p>	Recolli- mate B	<table border="1" style="width: 100%; border-collapse: collapse;"> <tr> <td style="padding: 2px;"> Repetition Angle CNT[2] Ht: 241°01'30" Hm: 120°30'45" EXIT OSET REL HOLD </td> </tr> <tr> <td style="padding: 2px;"> Doubled angle </td> </tr> <tr> <td style="padding: 2px;"> <table border="1" style="width: 100%; border-collapse: collapse;"> <tr> <td style="padding: 2px;"> Repetition Angle CNT[4] Ht: 482°02'50" Hm: 120°30'43" EXIT OSET REL HOLD </td> </tr> <tr> <td style="padding: 2px;"> Quadrupled angle. </td> </tr> </table> </td> </tr> </table>	Repetition Angle CNT[2] Ht: 241°01'30" Hm: 120°30'45" EXIT OSET REL HOLD	Doubled angle	<table border="1" style="width: 100%; border-collapse: collapse;"> <tr> <td style="padding: 2px;"> Repetition Angle CNT[4] Ht: 482°02'50" Hm: 120°30'43" EXIT OSET REL HOLD </td> </tr> <tr> <td style="padding: 2px;"> Quadrupled angle. </td> </tr> </table>	Repetition Angle CNT[4] Ht: 482°02'50" Hm: 120°30'43" EXIT OSET REL HOLD	Quadrupled angle.
Repetition Angle CNT[2] Ht: 241°01'30" Hm: 120°30'45" EXIT OSET REL HOLD							
Doubled angle							
<table border="1" style="width: 100%; border-collapse: collapse;"> <tr> <td style="padding: 2px;"> Repetition Angle CNT[4] Ht: 482°02'50" Hm: 120°30'43" EXIT OSET REL HOLD </td> </tr> <tr> <td style="padding: 2px;"> Quadrupled angle. </td> </tr> </table>	Repetition Angle CNT[4] Ht: 482°02'50" Hm: 120°30'43" EXIT OSET REL HOLD	Quadrupled angle.					
Repetition Angle CNT[4] Ht: 482°02'50" Hm: 120°30'43" EXIT OSET REL HOLD							
Quadrupled angle.							
<ul style="list-style-type: none"> ● Horizontal angle can be accumulated up to (3600;00'00" - minimum reading)(horizontal angle right) or -(3600;00'00" - minimum reading)(horizontal angle left). In case of 5 second reading, horizontal angle can be accumulated up to -3599;59'55". ● To stop the repetition angle measurement mode, press [F1](EXIT) and [F5](YES) key. 							

4.6 Layout

The layout program will assist the user to stakeout point numbers with coordinate values (NEZ) on the job site. The coordinate points can be transferred to and from the internal memory of the GTS-600 series using a PC. The communication parameters are selectable on the GTS-600 series for Baud rate, parity, stop bit, and protocol.

Coordinate data consist of a point number with north, east and elevation coordinates. The coordinate data is stored in job names. A Job name can be up to **10** characters long. A maximum of **1000** coordinate points can be stored in memory. A total of **10** jobs having **100** coordinate points or **2** jobs having **500** points each can be stored in the instrument. Job names can be alpha and numeric. Job can be renamed within the Job Manager option. If point numbers are not found in a job during the layout setup procedures, the software will prompt the user for the coordinate values. When using duplicate point number's in a job, the last duplicate point number stored in memory will be used. All other points having the same number will be ignored.

A job name must be created or selected to store coordinate values for the side shot or resection routine. If a job name is not created when doing the side shot or resection routine, the GTS-600 series will automatically create a default job identifies as (???1). The default job consists of three question marks followed by a numeric value starting with (1) for the first default job. When there are multiple jobs in the GTS-600 memory, the current job or the last job selected is where the coordinates are stored. The software provides two options to delete coordinate points within a job, Erase a Block of Points or Erase One Point.

Two programs, Side shot and Resection, are available under the New Point option that will calculate coordinates and store them in the current job. The side shot program calculate the coordinates (NEZ) from the angle and distance measured. Instrument height and rod height are used to calculate the (Z) coordinate.

In the Resection program the angle and distance measured to two know points, stored in the job, are used to measure and calculate the coordinate values for the new occupied point number. After measuring the known points, the residual error for the horizontal distance and elevation are shown on the display. There is an option to record the new occupied point in the job.

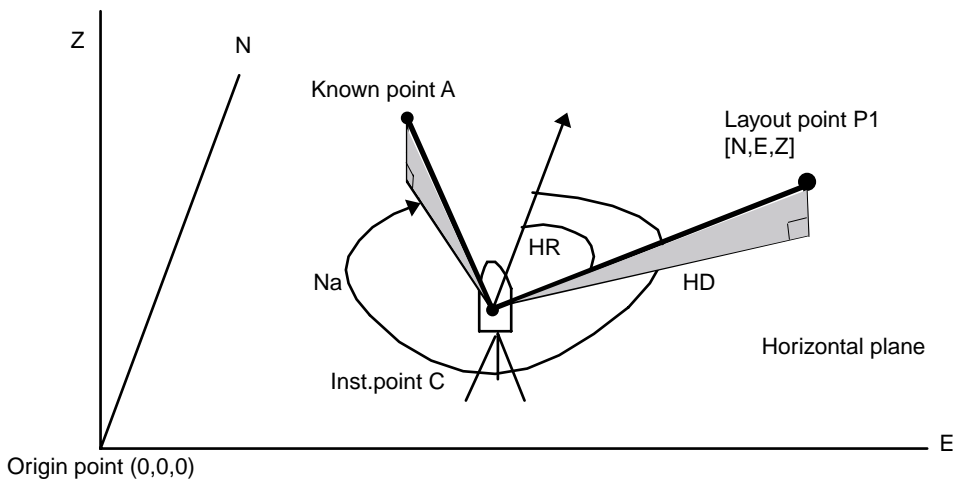

4.6.1 Options

The option routines provide features for selecting jobs, job maintenance and transferring jobs to and from the GTS-600. In the (Create or Select a job) routine, the user can scroll through memory to select a job by pressing the soft key assigned to the job.

In the Job Manager option, the user can View Jobs in Memory, Erase Points in a Job, Create Jobs, Transfer Jobs, Delete and Rename Jobs.

Examples are provided below for all the routines for the Options.

Create or Select a Job

In the Create or Select a Job option, all the jobs in memory are shown on the display. If there are more than four jobs in memory, pressing the (MORE) [F6] key will page down to view other jobs. Once a job is highlighted, press the soft key for that job to become the current job.

Operating procedure	Operation	Display																
<p>1 From the Main Menu Icons, press the [F4] (Options) key.</p>	<p>[F4]</p>	<div style="border: 1px solid black; padding: 5px;"> <p>LAYOUT</p> <p>F1 Setting Direction Angle</p> <p>F2 Setting Layout Point</p> <p>F3 Coordinate data</p> <p>F4 Options</p> </div> <div style="border: 1px solid black; padding: 5px; margin-top: 5px;"> <p>Options</p> <p>F1 Create or Select a Job</p> <p>F2 Job Manager</p> </div>																
<p>2 In the Options menu select [F1] (Create or Selection a Job).</p>	<p>[F1]</p>	<div style="border: 1px solid black; padding: 5px;"> <p>Select a Job (Job,# of Pts)</p> <table border="1" style="width: 100%; border-collapse: collapse;"> <tr> <td style="width: 10%;">F1</td> <td style="width: 40%;">TAC1</td> <td style="width: 20%;">25</td> <td style="width: 30%;">4/6</td> </tr> <tr> <td>F2</td> <td>TOPCON</td> <td>20</td> <td></td> </tr> <tr> <td>F3</td> <td>TAC2</td> <td>10</td> <td></td> </tr> <tr> <td>F4</td> <td>NEW</td> <td>10</td> <td>MORE</td> </tr> </table> </div>	F1	TAC1	25	4/6	F2	TOPCON	20		F3	TAC2	10		F4	NEW	10	MORE
F1	TAC1	25	4/6															
F2	TOPCON	20																
F3	TAC2	10																
F4	NEW	10	MORE															
<p>3 The jobs that are in memory will show on the screen. If there are more than four jobs in memory, the [F6] (MORE) will scroll to the other pages.</p>	<p>[F6]</p>	<div style="border: 1px solid black; padding: 5px;"> <p>Select a Job (Job,# of Pts)</p> <table border="1" style="width: 100%; border-collapse: collapse;"> <tr> <td style="width: 10%;">F1</td> <td style="width: 40%;">TAC1</td> <td style="width: 20%;">25</td> <td style="width: 30%;">4/6</td> </tr> <tr> <td>F2</td> <td>TOPCON</td> <td>20</td> <td></td> </tr> <tr> <td>F3</td> <td>TAC2</td> <td>10</td> <td></td> </tr> <tr> <td>F4</td> <td>NEW</td> <td>10</td> <td>MORE</td> </tr> </table> </div>	F1	TAC1	25	4/6	F2	TOPCON	20		F3	TAC2	10		F4	NEW	10	MORE
F1	TAC1	25	4/6															
F2	TOPCON	20																
F3	TAC2	10																
F4	NEW	10	MORE															
<p>4 To select a job, press the soft key that represents the job. EXAMPLE; To select the job, TAC2, press the [F3] key.</p>	<p>[F3]</p>	<div style="border: 1px solid black; padding: 5px;"> <p>LAYOUT</p> <table border="1" style="width: 100%; border-collapse: collapse;"> <tr> <td style="width: 10%;">F1</td> <td style="width: 40%;">Job Name</td> <td style="width: 20%;">TAC2</td> <td style="width: 30%;"></td> </tr> <tr> <td>F2</td> <td># of Pts</td> <td>10</td> <td></td> </tr> <tr> <td>F3</td> <td>Grid Factor</td> <td>1.000000</td> <td></td> </tr> </table> <p>F4 Options</p> </div>	F1	Job Name	TAC2		F2	# of Pts	10		F3	Grid Factor	1.000000					
F1	Job Name	TAC2																
F2	# of Pts	10																
F3	Grid Factor	1.000000																
<p>5 The LAYOUT screen appears in the back ground with the current job information in front.</p>		<div style="border: 1px solid black; padding: 5px;"> <p>LAYOUT</p> <p>F1 Setting Direction Angle</p> <p>F2 Setting Layout Point</p> <p>F3 Coordinate data</p> <p>F4 Options</p> </div>																
<p>6 Once the job information disappears from the display, the layout menu appears on the display and that job becomes the current job.</p>																		

Job Manager (Page 1)

In the Job Manager option there are two pages of routines for managing jobs. The first page of routines allows the user to View Memory, Erase a Block of Data, Erase One Point, and Create Another Job. The view memory shows all jobs in memory and allows the user to select another job if necessary. The erase a block of points and erase one point requests the record number in order to delete points in the job. If a new job is to be created, the last routine on page one allows the user to create the job. In order for the job to be created, the first point number and coordinates must be entered before you exit the routine. Below are examples for the Options routines.

View Memory

The view memory routine shows all the jobs stored in memory. This routine also allows the user to select another job in memory. There can be multiple pages of jobs. The [F6] (MORE) key scrolls to each page.

Operating procedure	Operation	Display																
<p>1 At the Layout display, press [F4] Options.</p>	[F4]	<p>LAYOUT F1 Setting Direction Angle F2 Setting Layout Point F3 Coordinate data F4 Options</p>																
		<p>Options F1 Create or Select a Job F2 Job Manager</p>																
<p>2 Press [F2] Job Manager.</p>	[F2]	<p>Job Manager (Pg 1/2) F1 View Memory F2 Erase a Block of Point F3 Erase One Point F4 Create Another Job ↓</p>																
<p>3 Press [F1] View Memory.</p>	[F1]	<p>Select a Job (Job,# of Pts)</p> <table border="1"> <tr> <td>F1</td> <td>TAC1</td> <td>25</td> <td>4/6</td> </tr> <tr> <td>F2</td> <td>TOPCON</td> <td>20</td> <td></td> </tr> <tr> <td>F3</td> <td>TAC2</td> <td>10</td> <td></td> </tr> <tr> <td>F4</td> <td>NEW</td> <td>10</td> <td>MORE</td> </tr> </table>	F1	TAC1	25	4/6	F2	TOPCON	20		F3	TAC2	10		F4	NEW	10	MORE
F1	TAC1	25	4/6															
F2	TOPCON	20																
F3	TAC2	10																
F4	NEW	10	MORE															
<p>4 The display shows all the jobs in memory on the first page. The current job is highlighted. The job name and number of points in the job are also shown on the display. To view more jobs on the second page, press [F6]. To exit from this screen, press the (ESC) key.</p>																		

Erase a Block of Points or Erase One Point

A block of point numbers can be erased within a job. To erase a block of points, the record numbers representing the points are entered. After typing in the block of record numbers, press the (ENT) key. The software will prompt the user to answer the question (YES) or (NO) to erase the record number. If (YES) is selected, the block of record numbers (points) will be erased. If (NO) is selected, the message (Cancel) will appear on the display for a few seconds and the Job Manager menu will appear. Another option in Job Manager is to erase one point This routine works the same as erasing a block of points, but only one record is erased at a time. Follow the examples below to erase a block of points and to erase one point.

Erase a Block of points

Operating procedure	Operation	Display
<p>1 At the Job Manager menu press [F2] Erase One Points.</p> <p>2 The next screen allows the user to type in the record number. Press (ENT) after typing the record number. If a wrong number is typed in, press [F6] to back space.To Exit, Press [F1].</p> <p>3 The next screen allows the user to continue erasing the record or to cancel the routine without erasing the record. Press [F5] to erase the record or [F6] not to erase the record. Pressing [F6] will cancel the routine and return back to the Job Manager menu.</p>	[F2]	<pre> Job Manager (Pg 1/2) F1 View Memory F2 Erase a Block of Point F3 Erase One Point F4 Create Another Job ↓ </pre>
	[ENT]	<pre> Erase a Block of Point REC # □-□ EXIT BS </pre>
	[F6] OR [F1]	<pre> Erase a Block of Point REC # [001-009] Erase OK? YES NO </pre>
	[F5] OR [F6]	

Erase One Point

Operating procedure	Operation	Display
<p>1 At the Job Manager menu press [F3] Erase One Points.</p> <p>2 The next screen allows the input the of record numbers to erase. Press (ENT) after typing each record number. If a wrong number is typed in, press [F6] to back space.To exit this routine, Press [F1].</p> <p>3 The next screen allows the user to continue erasing the block of records or to cancel the routine without erasing. Press [F5] to erase the record or [F6] not to erase the record. Pressing [F6] will cancel the routine and return back to the Job Manager menu.</p>	[F3]	<pre> Job Manager (Pg 1/2) F1 View Memory F2 Erase a Block of Point F3 Erase One Point F4 Create Another Job ↓ </pre>
	[ENT]	<pre> Erase One Point REC # □ EXIT BS </pre>
	[F6] OR [F1]	<pre> Erase One Point REC # [001] Erase OK? YES NO </pre>
	[F5] OR [F6]	

Create Another Job

This option creates a new job and store the job memory. The job name can be alpha / numeric. If a job name is not typed in, a default job name is used that has three question marks (???) followed by a numeric value. After typing in the job name, press the (ENT) key to accept the name. The coordinate input prompt appears to type in the first point number. After entering in the point number, the next screen appears to type in the coordinates. Once the coordinates are entered, the job is stored in memory. If you exit the point number or coordinate input screen, the job name will not be created and stored in memory.

The example below shows how to create a job name.

Operating procedure	Operation	Display
		<pre> Job Manager (Pg 1/2) F1 View Memory F2 Erase a Block of Point F3 Erase One Point F4 Create Another Job ↓ </pre>
<p>1 At the Job Manager menu press [F4] Create Another Job.</p>	<p>[F4]</p>	<pre> Job Name [???)1] </pre>
	<p>[ENT]</p>	<pre> Alpha SPC <- -> </pre>
<p>2 The prompt screen appears to type in a job name. Type in the job name which can be alpha or numeric and press (ENT) to accept the name. (Refer to section 2.9 for Alpha and Numeric input).</p>	<p>Select Number</p>	<pre> REC # 1PT#:[] Alpha SPC <- -> ↓ ↑ </pre>
<p>3 The next prompt screen is to input the point number. The record number is shown in the upper left corner of the display. If you escape from this screen, the job name will not be created or stored in memory. You must complete this screen and continue to the coordinate input screen to create the job. If you don t want to create and store the job, press the (ESC) key.</p>		
<p>4 Input the coordinates and press (ENT) after each value is typed in. If you escape from this screen before entering the coordinates, the job will not be created or stored in memory. After the rst point is stored, you may escape. The (BS) key allows the cursor to move from right to left to edit the input data. Press [F1] or the (ESC) to exit.</p>	<p>[ENT]</p>	<pre> 1 PT# 1 N : [] E : Z : EXIT BS </pre>
<p>5 The point number input prompt screen appears and the record number and point number increments +1. You may continue or exit this routine by pressing [F1] (EXIT).</p>	<p>[ENT]</p>	<pre> REC # 2PT#:[2] Alpha SPC <- -> ↓ ↑ </pre>

Job Manager (Page 2)

Page two of the Job Manager menu provides the options to Transfer Jobs, Rename a Job, Delete a Job, or Delete All Jobs.

The transfer data option sends and receives coordinates to and from the computer. The communications parameters are set by the user for Protocol, Baud rate, Parity, and Stop bits. Topcon's interface cable from the GTS-600 to the computer is used for the data transfer.

Job names can be renamed by using the Rename a Job option. When the rename option is selected, the current job will be renamed unless you select a different job using the View Memory option.

There are two options to delete jobs in memory, Delete a Job and Delete All Jobs. The Delete a Job option will delete one job from memory. The current job is erased unless another job is selected using the View Memory option. The Delete All Jobs option will erase all the jobs in memory.

Transfer Jobs

The protocol default parameters are highlighted on the GTS-600 series.

```
Protocol:  ACK/NAK
Baud rate:9600
Parity    :8/None
Stop bits:1
```

The Transfer Jobs option will send and receive jobs to and from the PC. In the receive option, the software in the instrument will not allow the new job from the PC to overwrite the current job. A warning "Coordinate data file already exists" will appear when receiving the job from the PC. If you select (YES), the current job is erased and the job received from the PC is added to memory. If you select (NO), a message appears to receive another job without erasing the current job. This will add the new job to memory and the received job becomes the current job.

The send option will transfer jobs from the instrument to the PC. The current job will be sent to the PC unless you select another job.

COMM Protocol

Before sending and receiving jobs to the instrument, the protocol parameters on the instrument should be checked. Make sure the protocol parameters match the PC software.

Follow the example below to select the protocol parameters.

Operating procedure	Operation	Display
<p>1 From the Job Manager menu, page 1, press [F6] to select page 2.</p>		<pre>Job Manager (Pg 1/2) F1 View Memory F2 Erase a Block of Point F3 Erase One Point F4 Create Another Job ↓</pre>
<p>2 Press [F1] Transfer Jobs</p>		
<p>3 To select the protocol parameters, press [F3] Comm Protocol.</p>	[F6]	<pre>Job Manager (Pg 2/2) F1 Transfer Jobs F2 Rename Jobs F3 Delete a Job F4 Delete All Job ↑</pre>
<p>4 To change a parameter, the cursor must be blinking on the parameter. To move the cursor up or down to each parameter, press [F5] (↑) or [F6] (↓). To move the cursor from left to right or vice-versa, press the [F4] (->) or [F3] (<-). The default parameters are highlighted. To return back to the Transfer Coordinate data menu, press [F2].</p>	[F1]	<pre>Transfer Coordinate data F1 Receive Coords. F2 Send Coords. F3 Comm Protocol</pre>
	[F3]	<pre>Protocol :ACK/NAK Baud Rate :9600 C./P. :ODD8/NONE Stop Bits :1 SET EXIT <- -> ↓ ↑</pre>
<p>5 To change the Baud rate, press [F6] (↓). The cursor will move down to the default Baud rate and continues to blink.</p>	[F6]	<pre>Protocol :ACK/NAK Baud Rate :9600 C./P. :ODD8/NONE Stop Bits :1 SET EXIT <- -> ↓ ↑</pre>
<p>6 To select a new Baud rate, press [F3] or [F4] to move the cursor over the new Baud rate. If no other parameters are to be changed, press [F1] (SET) to store the new Baud rate. If you would like to change other parameters, you may do so before pressing [F1] (SET). Once you are satisfied with the protocol parameters, press [F1] to store the new parameters. If you forget to press [F1] to set the new parameter, the selection you have made will not be stored and the previous setting will remain as the default.</p>	[F1]	<pre>Protocol :ACK/NAK Baud Rate :2400 C./P. :ODD8/NONE Stop Bits :1 SET EXIT <- -> ↓ ↑</pre>
<p>7 When [F1] (SET) is pressed, the screen to set the new parameters will appear. To set the parameters press [F5] (YES). If you do not want to set the changed parameters, press [F6] (NO) and the message (Cancel) will appear for a few seconds and return back to the Transfer Coordinate data menu.</p>	[F1]	<pre>Transfer Coordinate data Comm Protocol >Set OK? YES NO</pre>
<p>8 After pressing [F5] (YES), the message (Complete) appears for a few seconds then the Transfer Coordinate data menu appears.</p>	[F5]	<pre>Complete</pre>

Receive Coordinates

The receive coordinate option receives jobs from the PC to the GTS-600. Before receiving any jobs, make sure that the communication parameters in the instrument match the software parameters on the PC software.

Operating procedure	Operation	Display
<p>1 From the Job Manager menu, page 1, press [F6] key to select page 2.</p> <p>2 Press [F1] Transfer Jobs</p>	[F6]	<pre> Job Manager (Pg 1/2) F1 View Memory F2 Erase a Block of Point F3 Erase One Point F4 Create Another Job ↓ </pre>
<p>3 To receive a job press [F1].</p>	[F1]	<pre> Job Manager (Pg 2/2) F1 Transfer Jobs F2 Rename Job F3 Delete a Job F4 Delete All Jobs ↑ </pre>
<p>4 Press [F5] (YES). Pressing [F6] (NO) returns to the Job Manager menu.</p>	[F1]	<pre> Transfer Coordinate data F1 Receive Coords. F2 Send Coords. F3 Comm Protocol </pre>
<p>5 A warning message will appear if a job exists in memory. If you select [F5] (YES) to overwrite the job, the current job will be erased. If you do not want to overwrite the current job, press [F6] (NO). If there are no jobs in memory the receiving coordinate data screen will appear as in step 7. For the example press [F6] (NO).</p>	[F1]	<pre> Transfer Coordinate data Receive Coords. >Ready YES NO </pre>
<p>6 The next screen continues with the receive job option and allows for another job to be received. Pressing [F5] (YES) will add the job received from the PC to memory without erasing the current job. Pressing [F6] will abort the receive option and return back to page two of the Job Manager menu. For this example press [F5] (YES). On the PC execute the send option.</p>	[F5]	<pre> Warning!! Coordinate data file already exists >Overwrite ? YES NO </pre>
<p>7 On the receiving screen, the asterisk (*) appears with the cursor blinking over the asterisk. To stop the data transfer, press [F6] (STOP). When the job is completely received the Job Manager page 2 menu appears.</p>	[F5]	<pre> Continue Coordinate data file already exists >Another Job ? YES NO </pre>
	[F5]	<pre> Transfer Coordinate data Receive Coords. * >Receiving STOP </pre>

Send Coordinates

The send coordinate option will transfer a job from the instrument to a PC. If the current job is not the job you want to send, change the current job by going to the View Memory option on page 1 of the Job Manager Menu. Refer to the View Memory option for instructions on selecting a job. After confirming the job you want to send, check the communication parameters on the instrument and the PC software to make sure they match. Setup the PC first to receive the job. When the PC is ready, choose the (Send Coords.) option on the Transfer Coordinate data menu.

The example below shows how to send a job to the PC.

Operating procedure	Operation	Display
<p>1 From the Job Manager menu, page 1, press [F6] key to select page 2.</p>	[F6]	<pre>Job Manager (Pg 1/2) F1 View Memory F2 Erase a Block of Point F3 Erase One Point F4 Create Another Job ↓</pre>
		<pre>Job Manager (Pg 2/2) F1 Transfer Job F2 Rename Jobs F3 Delete a Job F4 Delete All Jobs ↑</pre>
<p>2 Press [F1] Transfer Jobs</p>	[F1]	<pre>Transfer Coordinate data F1 Receive Coords. F2 Send Coords. F3 Comm Protocol</pre>
<p>3 To send a job press [F2].</p>	[F2]	<pre>Transfer Coordinate data Send Coords. >Ready YES NO</pre>
<p>4 Get the PC software ready to receive the job. When the PC is ready, press [F5] (YES) to send the job. If you press [F6] (NO), the software will return back to page 2 of the Job Manager menu. Press [F5] (YES) to send the job.</p>	[F5]	<pre>Transfer Coordinate data Send Coords. >Waiting STOP</pre>
<p>5 The next screen waits for the PC to start sending the job. To abort the send job option press [F6].</p>	[F6]	<pre>Job Manager (Pg 2/2) F1 Transfer Jobs F2 Rename Job F3 Delete a Job F4 Delete All Jobs ↑</pre>
<p>6 Once the job is sent the screen shows the message Complete and returns back to page 2 of the Job Manager menu.</p>		

Rename a Job

This option renames the current job. If the current job is not the job you wish to rename, refer to the View Memory option to select another job.

The following example shows the rename option.

Operating procedure	Operation	Display
<p>1 From the Job Manager menu, page 1, press [F6] key to select page 2.</p> <p>2 Press [F1] Rename a Job. Make sure the correct job is the current job.</p> <p>3 The current job is shown with the cursor blinking on the first character. Type in the new job name and press the (ENT) key when complete. (Refer to section 2.9 for alpha / numeric entry).</p> <p>4 After pressing the (ENT) key, the Job Manager menu appears. To make sure the job name was changed, go to the View Manager option to see the new job name.</p>		<pre>Job Manager (Pg 1/2) F1 View Memory F2 Erase a Block of Point F3 Erase One Point F4 Create Another Job ↓</pre>
	[F6]	<pre>Job Manager (Pg 2/2) F1 Transfer Jobs F2 Rename Job F3 Delete a Job F4 Delete All Jobs ↑</pre>
	[F1] Type Job Name	<pre>Job Name Type Job Name Alpha SPC <- -></pre>
	(ENT)	<pre>Job Manager (Pg 2/2) F1 Transfer Jobs F2 Rename Job F3 Delete a Job F4 Delete All Jobs ↑</pre>

Delete a Job

The Delete Job option will erase the current job or the selected job from memory. Be sure to select the job you want to erase before you access the delete option.

Operating procedure	Operation	Display
<p>1 At the Job Manager page 2 menus, press [F3] Delete a Job. Make sure the correct job to delete is the current job.</p> <p>2 The current job is shown on the display. To delete the job press [F5] (YES). If you decide not to delete the job, press [F6] (NO).</p> <p>3 Once the job is erased from memory, the message Delete coordinate data appears and page 2 of the Job Manager menu appears.</p>		<pre>Job Manager (Pg 2/2) F1 Transfer Jobs F2 Rename Job F3 Delete a Job F4 Delete All Jobs ↑</pre>
	[F3]	<pre>Delete a Job [TAC] Delete OK ? YES NO</pre>
	(ENT)	<pre>Delete coordinate data</pre>

4.6.2 Coordinate Data

There are 4 routines in the Coordinate data option, Input Coordinate data, Search and View Jobs, New Point, and Grid Factor.

Input Coordinate Data

The input coordinate data routine is used to manually type in point numbers with coordinate values. If there are no job names found in memory, the software will ask to create one. If there is a job in memory the coordinates will be stored in the current job or another job name can be selected. Select a job name before choosing the Input Coordinate Data option. A job name can be a total of 10 characters, alpha and numeric. The job name is not created or stored in memory until you have stored the first point number with coordinates.

The first prompt screen is to input the point number. The (REC#) in the upper left corner of the display, represents the record number for the point number and it's coordinates. Once the point number entered, the next prompt screen allows the user to input the north, east and elevation. The [F6] key is the backspace key to move the cursor from right or left and the [F1] key is to exit back to the Coordinate data main menu. Press the [ENT] key to store each field of data. After entering the elevation data, the point number prompt display appears and increments the last point number (+1). Press the [ESC] key to cancel the coordinate data input option.

The instructions below show hoe to create a job name from the Coordinate data input option and manually type in a point number with coordinate values. (Assume that there are no job names memory for this example).

Operating procedure	Operation	Display
		<pre>LAYOUT F1 Setting Direction Angle F2 Setting Layout Point F3 Coordinate data F4 Options</pre>
1 Press [F3] for the Coordinate data option.	[F3]	<pre>Coordinate Data F1 Input Coordinate data F2 Search Data & View Jobs F3 New Point F4 Grid Factor</pre>
2 Press [F1] for Input Coordinate data.	[F1]	<pre>Job Name [???1] Alpha SPC <- -> ↓ ↑</pre>
3 The default name is (???1). Type in a job name. The name can be alpha or numeric. To type in a alpha character, press the [F1] key so the abbreviation (Num) appears.	Type Job Name	
4 After typing in the job name, press [ENT] key	[ENT]	<pre>Job Name [TAC1] Num SPC <- -> ↓ ↑</pre>
5 The cursor will blink in the rectangle box. Type in a point number and press the [ENT] key.	[ENT]	<pre>REC# 1 PT#: [TAC1] Alpha SPC <- -> ↓ ↑</pre>

4 PROGRAM MODE

- 6** The next screen is to type in the coordinates and press the [ENT] key after each entry. After entering in the elevation (Z) and pressing the [ENT] key, the job name, point number and coordinates are stored in memory.
- 7** The point number display appears and the point increments to PT#:2.

[ENT]

1	PT#:	1
	N:	<input type="text"/>
	E:	
	Z:	
EXIT		BS

[ENT]

REC#	<input type="text"/>				
2	PT#:				
Alpha	SPC	<-	->	↓	↑

4.6.3 Search Data and View Jobs

The Search Data and View Jobs option can find point numbers with coordinate values and show all jobs in memory. The options for the search feature are [F1] search first point number, [F2] last point number, or [F3] by any point number. Point numbers and coordinate values can not be edited in any search feature.

Another option in the Search Data and View Jobs is a feature that allows the user to view the job stored in memory by pressing the [F4] key. Also provided is the ability to select another job in memory. When searching for the side shot point number in a job, a line under the record number will be displayed, (3PT#:3). The resection point number stored in a job will show the record number in a box, (5 PT# 5)

Follow the instruction below for the Search Data & View Jobs option.

Operating procedure	Operation	Display
<p>1 From the options layout menu, press [F3] for the Coordinate data option.</p> <p>2 Press [F2] for the Search & View Jobs.</p>	<p>[F3]</p> <p>[F2]</p>	<div style="border: 1px solid black; padding: 5px;"> <p>LAYOUT</p> <p>F1 Setting Direction Angle</p> <p>F2 Setting Layout Point</p> <p>F3 Coordinate data</p> <p>F4 Options</p> </div> <div style="border: 1px solid black; padding: 5px; margin-top: 5px;"> <p>Coordinate Data</p> <p>F1 Input Coordinate data</p> <p>F2 Search Data & View Jobs</p> <p>F3 New Point</p> <p>F4 Grid Factor</p> </div>
<p>3 To search for the first point number, press [F1] (First).</p> <p>4 The first point number with coordinates appear on the display. To view more point numbers on the display, press [F6] (↓). Press [F1] to exit.</p>	<p>[F1]</p>	<div style="border: 1px solid black; padding: 5px;"> <p>Search Data & View Jobs</p> <p>F1 First</p> <p>F2 Last</p> <p>F3 PT#</p> <p>F4 View Memory</p> </div> <div style="border: 1px solid black; padding: 5px; margin-top: 5px;"> <p>1PT# :1</p> <p>N : 1000.000</p> <p>E : 1000.000</p> <p>Z : 100.000</p> <p>EXIT ↓ ↑</p> </div>
<p>3 To search for the last point number, press [F2] (Last).</p> <p>4 The last point number with coordinates appear on the display. To view more point numbers on the display, press [F5] (↓). Press [F1] to exit.</p>	<p>[F2]</p>	<div style="border: 1px solid black; padding: 5px;"> <p>Search Data & View Jobs</p> <p>F1 First</p> <p>F2 Last</p> <p>F3 PT#</p> <p>F4 View Memory</p> </div> <div style="border: 1px solid black; padding: 5px; margin-top: 5px;"> <p>50PT# :25</p> <p>N : 10.000</p> <p>E : 9.909</p> <p>Z : 98.75</p> <p>EXIT ↓ ↑</p> </div>

<p>3 To search by the point number, press [F3].</p> <p>4 Type in a point numbers press [ENT]. Press [F1] to exit.</p> <p>5 The point number and coordinates are shown on the display. Press [F1] (EXIT) to return to the Search Data & View Jobs menu.</p>	<p>[F3]</p> <p>Type Point Numbers</p> <p>[ENT]</p>	<div style="border: 1px solid black; padding: 5px;"> <p>Search Data & View Jobs</p> <hr/> <p>F1 First</p> <p>F2 Last</p> <p>F3 PT#</p> <p>F4 View Memory</p> </div> <div style="border: 1px solid black; padding: 5px; margin-top: 5px;"> <p>PT#: <input style="width: 50px;" type="text" value="2"/></p> <hr/> <p>Alpha SPC <- -> ↓ ↑</p> </div> <div style="border: 1px solid black; padding: 5px; margin-top: 5px;"> <p>2PT1#:2</p> <p>N: 1000.000</p> <p>E: 1000.000</p> <p>Z: 100.000</p> <p>EXIT ↓ ↑</p> </div>
---	--	---

View Jobs

Operating procedure	Operation	Display																
<p>1 Press [F4] to view jobs stored in memory.</p> <p>2 The jobs in memory are shown on the display. The job located a t (F1) is highlighted, indicating the current job. If you would like to select another job, press keys [F2] thorough [F4]. To view more jobs in memory, press the [F6] key. After each job name is the number of records (points) in job. The 1/2 is de ned as page of 2 Pages.</p>	<p>[F4]</p>	<div style="border: 1px solid black; padding: 5px;"> <p>Search Data & View Jobs</p> <hr/> <p>F1 First</p> <p>F2 Last</p> <p>F3 PT#</p> <p>F4 View Memory</p> </div> <div style="border: 1px solid black; padding: 5px; margin-top: 5px;"> <p>View Memory (Job, # of Pts)</p> <table border="1" style="width: 100%; border-collapse: collapse;"> <tr> <td style="width: 10%;">F1</td> <td style="width: 50%;">TAC1</td> <td style="width: 20%;">25</td> <td style="width: 20%;">4/6</td> </tr> <tr> <td>F2</td> <td>TOPCON</td> <td>20</td> <td></td> </tr> <tr> <td>F3</td> <td>TAC2</td> <td>10</td> <td></td> </tr> <tr> <td>F4</td> <td>NEW</td> <td>10</td> <td>MORE</td> </tr> </table> </div>	F1	TAC1	25	4/6	F2	TOPCON	20		F3	TAC2	10		F4	NEW	10	MORE
F1	TAC1	25	4/6															
F2	TOPCON	20																
F3	TAC2	10																
F4	NEW	10	MORE															

4.6.4 New Point

In the New Point option there are two features available to collect coordinates, Side Shot and Resection. When collecting a side shot point, the point number, north, east, and elevation are stored under a job name. The feature to set the back sight direction, Setting a Direction Angle, is optional when collecting a side shot point. The software provides the user with the option to set the direction angle or to skip this option. NOTE: If the direction angle to the back sight was established during the layout feature, and you haven't turned off the instrument, you can skip the Setting a Direction Angle feature in side shot collection. But, we recommend that you check the direction to the backsight before collecting side shot points.

Once the direction to the back sight is complete, the side shot point number and rod height are typed in and the instrument can be sighted on to the prism to collect the point coordinates.

Follow the instruction below to collect a side shot point.

Operating procedure	Operation	Display
<p>1 Press [F3] for the New Point option.</p>	<p>[F3]</p>	<pre>Coordinate Data F1 Input Coordinate data F2 Search Data & View Jobs F3 New Point F4 Grid Factor</pre>
<p>2 Press [F1] to collect side shot.</p>	<p>[F1]</p>	<pre>New Point F1 Side Shot F2 Resection-H,HD</pre>
<p>3 This screen allows the user to set a direction angle to the backsight or you can skip this if the direction was established during layout. We recommend that you check the direction to the backsight before collecting any side shot points. Press the [F6] key to set the direction.</p>	<p>[F6]</p>	<pre>New Point (Side Shot) Setting Direction Angle >Skip ? YES NO Setting Occupied Station PT#: [2] and Inst. Ht Alpha SPC <- -> ↓ ↑</pre>
<p>4 To continue with setting the direction angle, type in the occupied point number. If the coordinates are not stored in the job, the previous coordinates for the occupied point will appear. The coordinates can be changed by typing in the new values. If the point number with coordinates are stored in the job, the software will continue to the backsight point number input screen, step 5.</p>	<p>Type Point Number</p>	<pre>Setting Direction Angle BS:M-POINT N: 1000.000 E: 1000.000 INP OK</pre> <p>If the point number is not stored in the job, this screen appears. Press [F6] to accept coordinate values. Press [F1] to input new coordinates.</p>

5 The next screen appears to type in the backsight point number. If the point number is not stored in the job, an input screen appears to type in the coordinates. If the point number with coordinates are stored in the job the next screen appears, step 6, with the backsight direction.

[F6]
Type
Backsight
Point
Number

```

Setting Backsight Point
PT#: 3
-----
Alpha SPC <- -> ↓ ↑
    
```

6 If the backsight direction is correct, sight the instrument on the backsight point and press [F5] (YES) to set the direction. Press [F6] (NO) returns back to the Setting Backsight Point prompt on Step 5.

```

Setting Direction Angle
BS-T-POINT:
N : 
E : 
EXIT BS
    
```

If the point number is not stored in the job, this screen appears. Type in the coordinate values.

7 The next screen is to input the instrument height. Type in the instrument height and press the (ENT) key.

[F5]
Type
Inst.
Height

```

Setting Direction Angle
BS
H(B) : 225°00'00"
>Set OK?
YES NO
    
```

```

New Point (Side Shot)
Inst.Ht: 0.000
EXIT BS
    
```

8 This screen is to input the side shot point number. Type in the point number and press the (ENT) key.

(ENT)

```

New Point (Side Shot)
PT#: 
-----
Alpha SPC <- -> ↓ ↑
    
```

9 Type in the prism height and press the (ENT) key.

Type
Prism
Height

```

New Point (Side Shot)
R.Ht : 0.000
EXIT BS
    
```

10 Type in the side shot point number. Sight the instrument on the side shot point and when ready, press [F5] (YES) to measure and collect the data. If you press [F6] NO, the software will return back to the screen to input the side shot point number.

(ENT)
Type
Shot
Point
Number

```

New Point (Side Shot)
PT#:3
>Sight?
YES NO
    
```

11 After pressing the [F5] key, the instrument will measure the side shot point.

[F5]

```

HR: 225°00'00"
HD * <<
HV :
    
```

12 When the measurement is complete, the next screen shows the coordinates and allows the user to store the or not to store the data.

After the data is stored, the screen to type in another side shot point number appears, (step #8). Point number increments (+1).

Type
Shot
Point
Number

N:	9982773 m
E:	999.77. m
Z:	90.263 m
>Rec.New Point?	
	YES NO
New Point (Side Shot)	
PT#:	<input type="text" value="2"/>
Alpha SPC <- -> ↓ ↑	

Note:

Note : In the Search feature, a line is under the record number, (3_PT#:3) to identify the side shot from other points in the job.

Resection

The resection program calculates the new point (occupied point) coordinates from two known point numbers with coordinates that are stored in a job. The angle and distance is measured to each known point and the residual error for the horizontal distance and vertical distance are shown on the display. If the software can not calculate the new point, the message (Calc Error) appears. Once the residual error is accepted, the next display shows the coordinates for the new point. When the coordinates are viewed in the job, the record number is shown in a box, (10 PT#: 12).

The example below shows how to compute the resection point.

Operating procedure	Operation	Display
		<pre>Coordinate Data F1 Input Coordinate data F2 Search Data & View Jobs F3 New Point F4 Grid Factor</pre>
1 Press [F3] for the New Point option.	[F3]	<pre>New Point F1 Side Shot F2 Resection-H,HD</pre>
2 Press [F2] to compute a resection point.	[F2]	<pre>New Point (Resection-H, HD) Pt # 5</pre>
3 This screen allows the user to type in a point number for the new resection point. After typing in the print number press the (ENT) key to continue.	(ENT)	<pre>New Point (Resection-H, HD) Inst. Ht: 0.000</pre>
4 Input the instrument height. Type in the instrument height and press the (ENT) key.	Type Inst. Height	<pre>EXIT BS</pre>
5 Enter the 1st point number to measure that will be used to calculate the resection point.	(ENT) Type First Point Number	<pre>1st Pt#: 10</pre>
6 Enter the prism height and press the (ENT) key.	Type Prism Height	<pre>1st R. Ht: 0.000</pre>
7 Sight the instrument on to the 1st point. Once the instrument is locked on the point, press the [F5] key to measure the angle and distance. The [F6] key will return back to step 5).	(ENT) [F5]	<pre>1st Pt:10 >Sight ? YES NO</pre>

4.6.5 Grid Factor

A grid factor can be set when doing Layout, Resection or Side Shot. The formula below shows how the grid factor is calculated for the distance.

Calculation Formula

1) Elevation Factor

$$\text{Elevation Factor} = \frac{R}{R + \text{ELEV.}}$$

R : The average radius of the earth
ELEV. : The elevation above mean sea level

2) Scale Factor

Scale Factor : Scale Factor at the surveying station

3) Grid Factor

$$\text{Grid Factor} = \text{Elevation Factor} \times \text{Scale Factor}$$

Distance Calculation

1) Grid Distance

$$\text{HDg} = \text{HD} \times \text{Grid Factor}$$

HDg : Grid distance
HD : Ground distance

2) Ground Distance

$$\text{HD} = \frac{\text{HDg}}{\text{Grid Factor}}$$

Operating procedure	Operation	Display
1 Press [F4] for Grid Factor.	[F4]	<div style="border: 1px solid black; padding: 5px;"> Coordinate Data F1 Input Coordinate data F2 Search Data & View Jobs F3 New Point F4 Grid Factor </div> <div style="border: 1px solid black; padding: 5px; margin-top: 5px;"> Grid Factor <div style="text-align: right;">1.000000</div> >Modify <div style="text-align: right;">YES NO</div> </div>
2 To modify the grid factor, press [F5]. If you select [F6] NO, the program returns to the Coordinate data menu.	[F5]	<div style="border: 1px solid black; padding: 5px; margin-top: 5px;"> Grid Factor ELEV. : <input style="width: 50px;" type="text" value="+0000"/> SCALE : 1.000000 EXIT BS </div>
3 Type in the elevation and press (ENT).	(ENT)	
4 Next type in the scale factor and press (ENT).	Type Scale Factor	<div style="border: 1px solid black; padding: 5px; margin-top: 5px;"> Grid Factor ELEV. : +0000 SCALE : <input style="width: 50px;" type="text" value="1.00000"/> EXIT BS </div>

4 PROGRAM MODE

<p>5 If the Grid factor acceptable, press the (ESC) key or [F6] (NO).</p>	(ENT)	<pre>Grid Factor 1.000000 >Modify YES NO</pre>
<p>6 After pressing (ESC), the coordinate data menu appears.</p>	(ESC)	<pre>Coordinate Data F1 Input Coordinate data F2 Search Data & View Jobs F3 New Point F4 Grid Factor</pre>

4.6.6 Setting a Direction Angle and Layout a Point

The direction angle option computes the backsight angle orientation using the occupied and backsight point coordinates. Once the backsight angle is set, you can safely layout points.

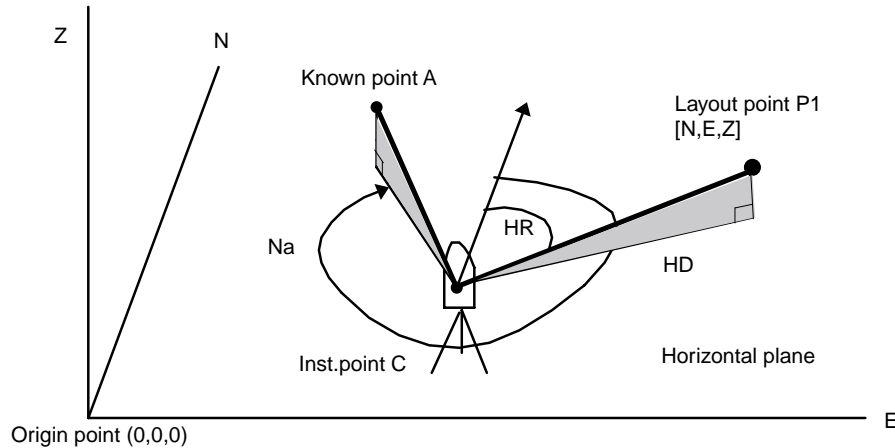

Operating procedure	Operation	Display
<p>1 From the Main Menu Icons, press the [F2] (Prog) Key.</p>	[F2]	<pre> Programs ----- F1 BS p 4/8 F2 STORE p F3 REM p F4 MLM p MORE </pre>
<p>2 Press the [F6] key to advance to the next screen.</p>	[F6]	<pre> Programs ----- F1 REP p 8/8 F2 LAYOUT p F3 LINE p F4 LOADER p MORE </pre>
<p>3 Press the [F2] (LAYOUT) key.</p> <p>The version number will appear on this screen for a few seconds.</p> <p>If a Job was created, the information screen about the job will appear.</p>	[F2]	<pre> LAYOUT Version x.xx LAYOUT ----- F Job Name TAC2 F # of Pts 10 F Grid Factor 1.000000 F4 </pre>

4 Press the [F1] key for the Setting Direction Angle option.

5 a
Type in the occupied point number. The point number can be alpha or numeric characters. If the point number begins with an alpha character, press the [F1] (ALPHA) key to (NUM) pre x must appear on the display to type in alpha characters. See Section 2.9 How to Enter Alpha and Numeric.

b
If the occupied point number is not stored in memory, the display prompts for the coordinate values. Press the [F1] (INP) key to input the occupied coordinates. If zero is the desired value, press [F6] (OK). If coordinate values other than zero are desired, type the coordinates and press the (ENT) key to accept each value.
NOTE: The point number and coordinates are not stored in memory after input.

6 a
The next display will prompt for the backsight point number. The point number can be alpha or numeric. If the point number and its coordinates are stored in memory, the display will advance to step **7**. If the point number and coordinates are not in memory, follow step **6 b**.

b
If the backsight point number is not stored in memory, the display prompts for the coordinate values. Type the coordinates and press (ENT) to accept each value.

The program will continue to step **7**.
NOTE: To escape from this step, press [F1] (EXIT) to return to step **4**.

The [F6] (BS) key moves the cursor to the left to edit the previous character.

```
LAYOUT
F1 Setting Direction Angle
F2 Setting Layout Point
F3 Coordinate data
F4 Options
```

[F1]

```
Setting Occupied Station
PT#:
```

Alpha SPC <- -> ↓ ↑

Type Point Number

[F1]

```
Setting Direction Angle
BS:M-Point
N : 0.000
E : 0.000
INP OK
```

Type Coord.

[F6]

```
Setting Backsight Point
PT#:
```

Alpha SPC <- -> ↓ ↑

Type BS. Point Number

```
Setting Direction Angle
BS:T-Point
N:
E:
EXIT BS
```

7 The next display shows the backsight angle. If the angle correct, sight and lock the instrument on the backsight point. Press [F5] (YES) to accept the backsight orientation. If you are not satisfied with the backsight angle, press [F6] (NO) to return to step **6 a**.

NOTE: Be sure you are sighted on the correct backsight point and answer (YES), the layout points will be incorrectly set.

8 Type in the instrument height and press (ENT).

9 a
Type in the point number to layout. If the point number and its coordinates are stored in memory, the display will advance to step **10**. If the point number and coordinates are not in memory, follow step **9 b**.

b
Type in the coordinates for the layout point. Press (ENT) after each values. The program will continue to step **10**.

10 Type in the prism height for the layout point.

11 The angle and distance to the layout point is shown on the display. From the backsight point, the instrument must be turned 50°10'16" to be online with the layout point. The horizontal distance of 20.234 m is the distance from the instrument to the layout point.

```
Setting Direction Angle
BS:
  H(B):      0°00'00"
>Set OK?
                YES  NO
```

Type
Inst.
Height

```
Setting Layout Point
Inst.ht:    0.000
EXIT                               BS
```

(ENT)

Type
Point
Number

```
Setting Layout Point
Inst.ht:    0.000
EXIT                               BS
```

Type
Coord.
(ENT)

```
PT# :    3
N  :
E  :
Z  :
EXIT                               BS
```

Type
Prism
Height

```
Setting Layout Point
R.HT:      0.00
EXIT                               BS
```

```
dHR = 52°10'16"
dHD = 20.234m
ANG DIST F/C NEZ GUIDE NEXT
```

[F1] [F2] [F3] [F4] [F5] [F6]

Explanation of options [F1] to [F6]

[F1] (ANG) - - This option will display the actual horizontal angle (HR) and the layout horizontal angle (dHR). When turning the instrument towards the layout point, the (HR) will count up to the layout angle and the (dHR) will count down to zero (0°0'0").

```
HD* = 0°00'00"
dHD = -52°10'15"
ANG DIST F/C NEZ GUIDE NEXT
```

[F1] [F2] [F3] [F4] [F5] [F6]

4 PROGRAM MODE

The angle option can be selected from any option [F2] - [F5].
 [F2] (DIST) - - Once the rod person is online with the instrument, the distance to set the layout point can be accomplished. The (HD) is the actual measured distance. The (dHD) is the amount of distance the rod person must move to be on the point. The distance measurement default is in the fine repeat mode.

[F3] (F/C) - - The [F3] key allows the instrument person to change the distance measurement mode from the coarse repeat mode to the fine repeat mode. Pressing the key once will change the mode. The vertical distance is only shown on the display in the fine repeat mode. Pressing [F3] a second time will change the distance measurement mode back to coarse repeat mode.

[F4] (NEZ) - - This option allows the instrument person to measure the coordinates after laying out the point.

[F5] (GUIDE) - - The guide option has distance features for the instrument person, to pass along instructions to the rod person, to layout the point. One option shows the distance to either move (BACK) towards the instrument or (GO) away from the instrument and (RIGHT) or (LEFT) distance to move onto the layout point in case the rod person might have strayed of line.

The cut or fill information is also shown on the display. This allows the instrument person to see the amount of dirt to cut or fill using the previous rod height. Refer to the Guide Option of this chapter for detailed instructions.

[F6] (NEXT) - - The (NEXT) option allows the instrument person to continue to layout another point.

(Coarse Repeat Screen)

```

HD*          < m
dHD = -52°10'15"
ANG DIST F/C NEZ GUIDE NEXT
    
```

[F1] [F2] [F3] [F4] [F5] [F6]

(Fine Repeat Screen)

```

HD*          < m
dHD :                m
dz :                m
ANG DIST F/C NEZ GUIDE NEXT
    
```

[F1] [F2] [F3] [F4] [F5] [F6]

```

N *          0.002 m
E :          -0.001 m
Z :          0.001 m
ANG DIST F/C NEZ GUIDE NEXT
    
```

[F1] [F2] [F3] [F4] [F5] [F6]

```

ARIGHT      1.448 m
EGO         0.923 m
EUP         1.234 m
ANG DIST F/C NEZ GUIDE NEXT
    
```

[F1] [F2] [F3] [F4] [F5] [F6]

```

Setting Layout Point
PT#:
ANG DIST F/C NEZ GUIDE NEXT
    
```

[F1] [F2] [F3] [F4] [F5] [F6]

4.6.7 Guidance Feature

The Guide feature can serve two purposes in the field for layout.

- One use for the Guide feature is to help get the rod person on the layout point faster and more accurately. This is accomplished by showing the instrument person distance instructions which are then passed on to the rod person. The distance instructions are to move (BACK), towards the instrument, (GO) away from the instrument, and to move (RIGHT) or (LEFT) to get back online with the layout point. The (RIGHT) and (LEFT) instructions are helpful when the rod person is very close to the layout point. Please refer to the diagram and instructions below.
- Another feature that layout accomplishes is the cut or fill information. Using the last rod height previously entered, the Total Station will display the cut (DOWN) or fill (UP) information to the instrument person.

Layout with Guide Feature

Refer to the previous section 4.6.2- Setting a Direction Angle and Layout a Point (step 1-11). At the layout screen, the example below will pick up at the Guide feature.

Operating procedure	Operation	Display
<p>1 From the angle and distance layout screen, press [F5] (GUIDE).</p>		<pre>dHR = 52°10'16" dHD = 20.234 m ANG DIST F/C NEZ GUIDE NEXT</pre>
<p>2 The next screen will display the distance to move right or left to the layout point and to move back toward the instrument or away from the instrument. The cut (DOWN) or ll (UP), on the last line of information, is calculated using the rod height previously entered.</p>	[F5]	<pre>→ RIGHT 1.448 m ↑ GO 0.923 m ↑ UP 1.234 m ANG DIST F/C NEZ GUIDE NEXT</pre>
<p>3 When the measuring point is within -5mm from standard layout point, the word KEEP and (+) or (-) signs are displayed.</p>		<pre>↔ KEEP 0.003 m ↓ KEEP -0.002 m ↑ KEEP 0.001 m ANG DIST F/C NEZ GUIDE NEXT</pre>

Function of GUIDANCE

Using the function of guidance, it is possible to guide a person of prism side as shown below. This function is useful when it is difficult to collimate the layout point (P1) directly during executing a layout mode.

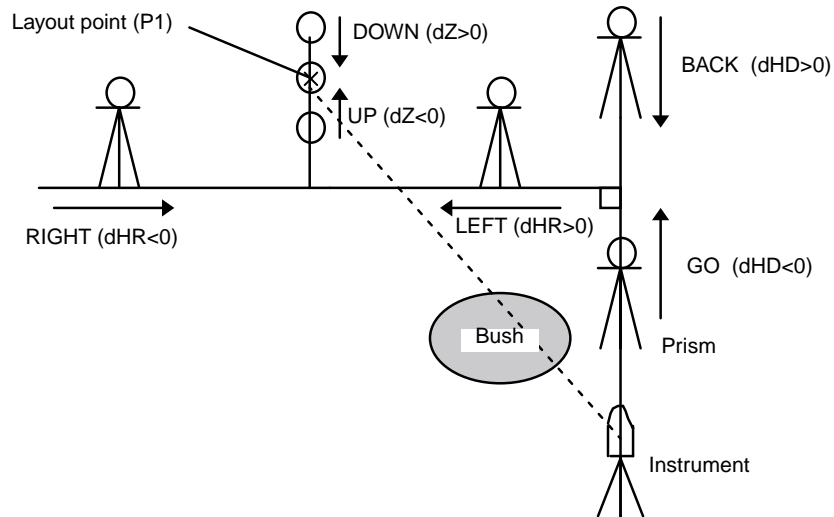

4.7 Line Measurement (LINE)

The Line Measurement program allows the user to measure the height of an inaccessible object above a point. Both the inaccessible object and the point are located along an established base line. Two prisms, A and B, are set up apart from each other below the object to established the base line. The horizontal distance is measured and set in the instrument for both prism A and B. The screen then shows the vertical distance from prism A and B, the horizontal distance from the instrument to prism B, and the distance along the base line and the screen will display the vertical distance from prism A to that point, the horizontal distance from that point. Additionally, the vertical distance between two points on the base line, Points G and L in the diagram, can be measured.

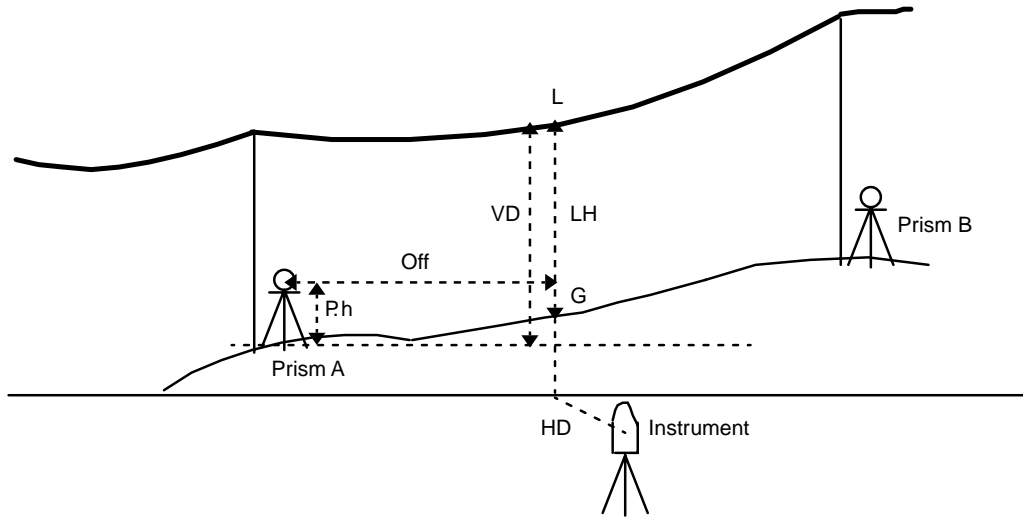

[Example:Input of prism height]

Operating procedure	Operation	Display
<p>1 Press [F6](MORE) key from programs menu to get the next page of programs.</p> <p>2 Press [F2](LINE) key.</p> <p>3 Press [F1](YES) key.</p>	[F6]	<pre> Programs ----- F1 BS p 4/9 F2 STORE p F3 REM p F4 MLM p MORE </pre>
	[F2]	<pre> Programs ----- F1 REP p 8/9 F2 LAYOUT p F3 LINE p F4 OFFSET p MORE </pre>
	[F1]	<pre> LINE Prism height 1 YES 2 NO </pre>
		<pre> LINE Prism height P.h: m EXIT BS </pre>

<p>4 Input the prism height and press [ENT] key.</p>	<p>Input P.h [ENT]</p>	<pre>LINE <STEP-1>PT A HD: m MEAS SET</pre>
<p>5 Collimate prism A and press [F1](MEAS) key. The distance measurement will start.</p> <p>Horizontal distance is displayed.</p>	<p>Collimate A [F1]</p>	<pre>LINE <STEP-1>PT A HD* < m MEAS SET</pre> <p style="text-align: center;">↓</p> <pre>LINE <STEP-1>PT A HD* 50.234 m MEAS SET</pre>
<p>6 Press [F6] (SET) key, and horizontal distance will be recorded.</p>	<p>[F6]</p>	<pre>LINE <STEP-1>PT B HD: m MEAS SET</pre>
<p>7 Collimate prism B and press [F1](MEAS) key. The distance measurement will start.</p> <p>Horizontal distance is displayed.</p>	<p>Collimate B [F1]</p>	<pre>LINE <STEP-1>PT B HD* < m MEAS SET</pre> <p style="text-align: center;">↓</p> <pre>LINE <STEP-1>PT B HD* 67.543 m MEAS SET</pre>
<p>8 Press [F6] (SET) key, and horizontal distance will be recorded.</p>	<p>[F6]</p>	<pre>LINE VD: 20.123 m HD: 38.987 m Off: 74.123 m EXIT LH</pre>
<p>9 Sight line point L . Measured data to the line point L is displayed. VD:Vertical distance. HD:Horizontal distance from the instrument to L. Off :Horizontal distance from A to L.</p>	<p>Sight L</p>	

<p>10 Press [F2](LH) key. This function is used when measuring the line height from the ground. The procedure is as follows :</p> <ul style="list-style-type: none"> ● Sight the point on the line before pressing this key. ● Don't move the horizontal tangent screw by setting ground point G. <p>11 Rotate the vertical tangent screw, and sight ground point G.</p> <p>12 Press [F6] (SET) key, line height (LH) and horizontal distance (Off) are displayed.</p>	<p>[F2]</p> <p>Sight G</p> <p>[F6]</p>	<div style="border: 1px solid black; padding: 5px; margin-bottom: 10px;"> LINE G-POINT V : 30°20'10" EXIT SET </div> <div style="border: 1px solid black; padding: 5px; margin-bottom: 10px;"> LINE G-POINT V : 90°40'20" EXIT SET </div> <div style="border: 1px solid black; padding: 5px;"> LINE LH: 33.765 m Off: 27.521 m EXIT VD NEXT </div>
<ul style="list-style-type: none"> ● To finish the measurement, press the [F1](EXIT) or [ESC] key. ● To return to operation procedure 9, press the [F2](VD) key. ● To return to operation procedure 11, press the [F6](NEXT) key. <p>The NEXT key is used when the ground point G is not clear and you would like to check another ground point G on the same vertical line.</p>		

4.8 Offset measurement (OFFSET)

There are four offset measurement modes in the Offset Measurement.

- Angle offset
- Distance offset
- Plane offset
- Column offset

Offset Measurement Menu

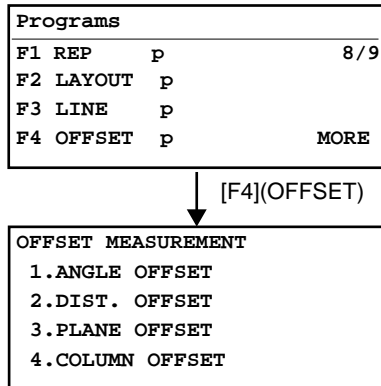

• Outputting the Measurement Data

The results of offset measurement can be output to external device.

In offset measurement mode, the [F4] soft key which assigned (REC) will appear in measured result display.

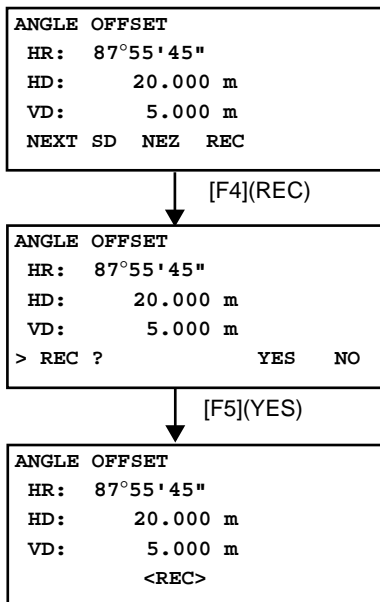

• Distance measurement mode of the offset measurement

Offset measurement will be done by N-time fine measurement mode.

4.8.1 Angle Offset

This mode is useful when it is difficult to set up the prism directly, for example at the center of a tree. Place the prism at the same horizontal distance from the instrument as that of point A₀ to measure. To measure the coordinates of the center position, operate the offset measurement after setting the instrument height/prism height.

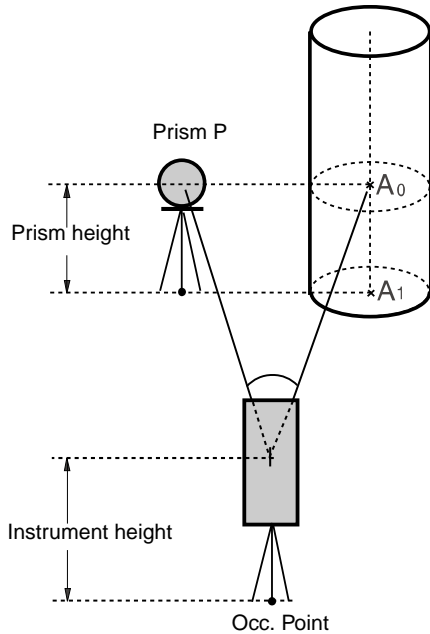

When measuring coordinates of ground point A₁: Set the instrument height/prism height.

When measuring coordinates of point A₀: Set the instrument height only. (Set the prism height to 0).

When sighting to A₀, you can select one of two ways. [HOLD] is to fix vertical angle to the prism position even updown the telescope position, and [FREE] is to gear vertical angle to the updown of telescope movement. In case following the vertical angle to the movement of telescope, SD(Slope Distance) and VD(Vertical Distance) will be changed according to the movement of telescope.

Operating procedure	Operation	Display																			
<p>1 Press [F6](MORE) key from programs menu to get to the next page of programs.</p>	[F6]	<table border="1"> <tr><td colspan="3">Programs</td></tr> <tr><td>F1</td><td>BS</td><td>p</td><td>4/9</td></tr> <tr><td>F2</td><td>STORE</td><td>p</td><td></td></tr> <tr><td>F3</td><td>REM</td><td>p</td><td></td></tr> <tr><td>F4</td><td>MLM</td><td>p</td><td>MORE</td></tr> </table>	Programs			F1	BS	p	4/9	F2	STORE	p		F3	REM	p		F4	MLM	p	MORE
		Programs																			
F1	BS	p	4/9																		
F2	STORE	p																			
F3	REM	p																			
F4	MLM	p	MORE																		
<p>2 Press [F4](OFFSET) key.</p>	[F4]	<table border="1"> <tr><td colspan="3">Programs</td></tr> <tr><td>F1</td><td>REP</td><td>p</td><td>8/9</td></tr> <tr><td>F2</td><td>LAYOUT</td><td>p</td><td></td></tr> <tr><td>F3</td><td>LINE</td><td>p</td><td></td></tr> <tr><td>F4</td><td>OFFSET</td><td>p</td><td>MORE</td></tr> </table>	Programs			F1	REP	p	8/9	F2	LAYOUT	p		F3	LINE	p		F4	OFFSET	p	MORE
		Programs																			
F1	REP	p	8/9																		
F2	LAYOUT	p																			
F3	LINE	p																			
F4	OFFSET	p	MORE																		
<p>3 Press [F1](ANGLE OFFSET) key.</p>	[F1]	<table border="1"> <tr><td colspan="3">OFFSET MEASUREMENT</td></tr> <tr><td colspan="3">1. ANGLE OFFSET</td></tr> <tr><td colspan="3">2. DIST. OFFSET</td></tr> <tr><td colspan="3">3. PLANE OFFSET</td></tr> <tr><td colspan="3">4. COLUMN OFFSET</td></tr> </table>	OFFSET MEASUREMENT			1. ANGLE OFFSET			2. DIST. OFFSET			3. PLANE OFFSET			4. COLUMN OFFSET						
		OFFSET MEASUREMENT																			
1. ANGLE OFFSET																					
2. DIST. OFFSET																					
3. PLANE OFFSET																					
4. COLUMN OFFSET																					
		<table border="1"> <tr><td colspan="3">ANGLE OFFSET</td></tr> <tr><td colspan="3">1. FREE V-ANGLE</td></tr> <tr><td colspan="3">2. HOLD V-ANGLE</td></tr> </table>	ANGLE OFFSET			1. FREE V-ANGLE			2. HOLD V-ANGLE												
ANGLE OFFSET																					
1. FREE V-ANGLE																					
2. HOLD V-ANGLE																					

4 PROGRAM MODE

<p>4 Select the vertical angle [FREE] or [HOLD]. *1)</p>	[F1]or [F2]	<div style="border: 1px solid black; padding: 5px;"> <p>ANGLE OFFSET</p> <p>HD: < m</p> <p>MEAS HT</p> </div>
<p>5 Collimate prism P, and press the [F1](MEAS) key. *1)</p> <p style="margin-top: 20px;">The horizontal distance from the instrument to the prism will be measured.</p>	Collimate P [F1]	<div style="border: 1px solid black; padding: 5px;"> <p>ANGLE OFFSET</p> <p>HD* m</p> <p>MEAS HT</p> </div> <p style="text-align: center;">↓</p> <div style="border: 1px solid black; padding: 5px;"> <p>ANGLE OFFSET</p> <p>HR: 20°30'40"</p> <p>HD: 20.000 m</p> <p>VD: 0.000 m</p> <p>MEAS HT</p> </div>
<p>6 Collimate point A₀ using the horizontal motion clamp and horizontal tangent screw.</p>	[F6]	<div style="border: 1px solid black; padding: 5px;"> <p>ANGLE OFFSET</p> <p>HR: 30°00'00"</p> <p>HD: 20.000 m</p> <p>VD: 0.000 m</p> <p>NEXT SD NEZ REC</p> </div>
<p>7 To show the slope distance of point A₀, press the [F2](SD) key.</p>	[F2]	<div style="border: 1px solid black; padding: 5px;"> <p>ANGLE OFFSET</p> <p>V : 90°00'00"</p> <p>HR: 30°00'00"</p> <p>SD: 20.000 m</p> <p>NEXT HD NEZ REC</p> </div>
<p>8 To show the coordinates, press the [F3](NEZ) key. *2)</p>	[F3]	<div style="border: 1px solid black; padding: 5px;"> <p>ANGLE OFFSET</p> <p>N : 17.321 m</p> <p>E : 10.000 m</p> <p>Z : 0.000 m</p> <p>NEXT SD HD REC</p> </div>
<p>*1) To set the prism height or instrument height, press the [F5](HT) key.</p> <p>*2) To repeat angle offset measurement, press the [F1](NEXT) key. The display will return to step 5.</p>		

4.8.2 Distance Offset Measurement

The measurement of a place apart from a prism is possible by inputting offset horizontal distance of front and back / right and left.

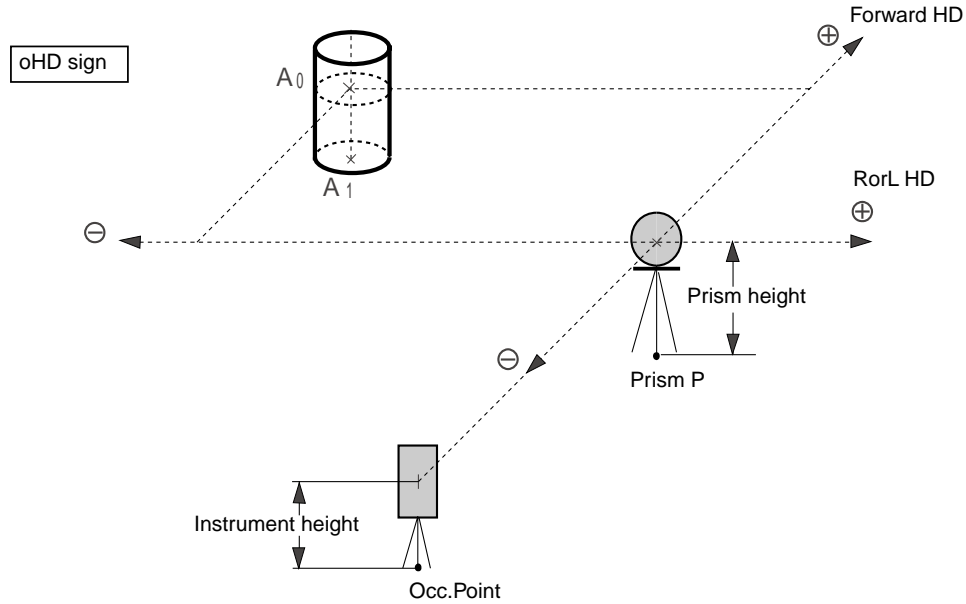

When measuring coordinates of ground point A_1 : Set the instrument height / prism height.

When measuring coordinates of point A_0 : Set the instrument height only.
(Set the prism height to 0).

Operating procedure	Operation	Display
<p>1 Press [F6](MORE) key from programs menu to get to the next page of programs.</p>	[F6]	<pre> Programs ----- F1 BS p 4/9 F2 STORE p F3 REM p F4 MLM p MORE </pre>
		<pre> Programs ----- F1 REP p 8/9 F2 LAYOUT p F3 LINE p F4 OFFSET p MORE </pre>
<p>2 Press [F4](OFFSET) key.</p>	[F4]	<pre> OFFSET MEASUREMENT 1.ANGLE OFFSET 2.DIST. OFFSET 3.PLANE OFFSET 4.COLUMN OFFSET </pre>
<p>3 Press [F2](DIST. OFFSET) key.</p> <p>Previous offset value screen will appear. dFR: Forward/Rear offset value dRL: Right/Left offset value</p>	[F2]	<pre> DIST. OFFSET dFR : 0.000 m dRL : 0.000 m OK INP </pre>

4 PROGRAM MODE

<p>4 If you reset the offset value, press the [F6](INP) key and input the value. *1)</p>	[F6]	<div style="border: 1px solid black; padding: 5px;"> <p>DIST. OFFSET</p> <p>dFR : 0.000 m</p> <p>dRL : 0.000 m</p> <p>EXIT BS</p> </div>
<p>5 Collimate prism using the horizontal motion clamp and horizontal tangent screw. Press the [F1](MEAS) key. *2)</p> <p style="margin-top: 20px;">The offset measurement data will be shown.</p>	Collimate P [F1]	<div style="border: 1px solid black; padding: 5px;"> <p>DIST. OFFSET</p> <p>HD: m</p> <p>MEAS HT</p> </div> <p style="text-align: center;">↓</p> <div style="border: 1px solid black; padding: 5px;"> <p>DIST. OFFSET</p> <p>HR: 30°00'00"</p> <p>HD: 20.000 m</p> <p>VD: 0.000 m</p> <p>NEXT SD NEZ REC</p> </div>
<p>6 To show the slope distance of point A₀, press the [F2](SD) key.</p>	[F2]	<div style="border: 1px solid black; padding: 5px;"> <p>DIST. OFFSET</p> <p>V : 90°00'00"</p> <p>HR: 30°00'00"</p> <p>SD: 20.000 m</p> <p>NEXT HD NEZ REC</p> </div>
<p>7 To show the coordinates, press the [F3](NEZ) key. *3)</p>	[F3]	<div style="border: 1px solid black; padding: 5px;"> <p>DIST. OFFSET</p> <p>N : 17.321 m</p> <p>E : 10.000 m</p> <p>Z : 0.000 m</p> <p>NEXT SD HD REC</p> </div>
<p>*1) To skip the input, press the [F1](OK) key. *2) To set the prism height or instrument height, press the [F5](HT) key. *3) To repeat the offset measurement, press the [F1](NEXT) key. The display will return to step 5.</p>		

4.8.3 Plane Offset Measurement

Measuring will be taken for the place where direct measuring can not be done, for example distance or coordinate measuring for a edge of a plane.

Three random target points (P1, P2, P3) on a plane will be measured at first in the plane offset measurement to determine the measured plane. Collimate the measuring target point (P0) then the instrument calculates and displays coordinate and distance value of cross point between collimation axis and of the plane.

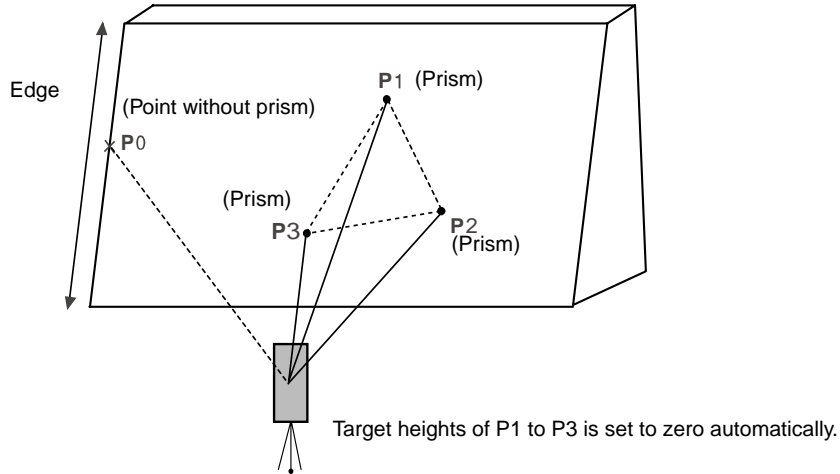

Operating procedure	Operation	Display
<p>1 Press [F6](MORE) key from programs menu to get to the next page of programs.</p> <p>2 Press [F4](OFFSET) key.</p> <p>3 Press [F3](PLANE OFFSET) key.</p> <p>Measurement screen of three points on a plane will be shown.</p>	[F6]	<pre> Programs ----- F1 BS p 4/9 F2 STORE p F3 REM p F4 MLM p MORE </pre>
	[F4]	<pre> Programs ----- F1 REP p 8/9 F2 LAYOUT p F3 LINE p F4 OFFSET p MORE </pre>
	[F3]	<pre> OFFSET MEASUREMENT 1.ANGLE OFFSET 2.DIST. OFFSET 3.PLANE OFFSET 4.COLUMN OFFSET </pre>
		<pre> PLANE OFFSET N001# SD : m MEAS HT </pre>

<p>4 Collimate prism P1, and press the [F1](MEAS) key. Measuring will start. After measuring, the second point measurement screen will be shown.</p>	<p>Collimate P1 [F1]</p>	<pre> PLANE OFFSET N002# SD : m MEAS HT </pre>
<p>5 Measure the second and third prism in the same way. *1)</p> <p>The instrument calculates and displays coordinate and distance value of cross point between collimation axis and of the plane. *2)</p>	<p>Collimate P2 [F1] Collimate P3 [F1]</p>	<pre> PLANE OFFSET N003# SD : m MEAS HT </pre> <p style="text-align: center;">↓</p> <pre> PLANE OFFSET HR: 85°30'40" HD: 54.321 m VD: 10.000 m NEXT SD NEZ REC </pre>
<p>6 Collimate point P0 on the plane using the horizontal motion clamp and horizontal tangent screw.</p> <p>P0 data will be shown.</p>	<p>Collimate P0</p>	<pre> PLANE OFFSET HR: 75°30'40" HD: 54.600 m VD: -0.487 m NEXT SD NEZ REC </pre>
<p>7 To show the slope distance of point P₀, press the [F2](SD) key.</p>	<p>[F2]</p>	<pre> DIST. OFFSET V : 90°30'30" HR: 75°30'40" SD: 54.602 m NEXT HD NEZ REC </pre>
<p>8 To show the coordinates, press the [F3](NEZ) key. *3)</p>	<p>[F3]</p>	<pre> DIST. OFFSET N : 17.321 m E : 10.000 m Z : 20.000 m NEXT SD HD REC </pre>
<p>*1) In case the calculation of plane was not successful by the measured three points, error displays. Start measuring over again from the first point. *2) Error will be displayed when collimated to the direction which does not cross with the determined plane *3) The reflector height of the target point P0 is set to zero automatically.</p>		

4.8.4 Column Offset Measurement

If it is possible to measure circumscription point (P1) of column directly, the distance to the center of the column (P0), coordinate and direction angle can be calculated by measured circumscription points (P2) and (P3).

The direction angle of the center of the column is 1/2 of total direction angle of circumscription points (P2) and (P3).

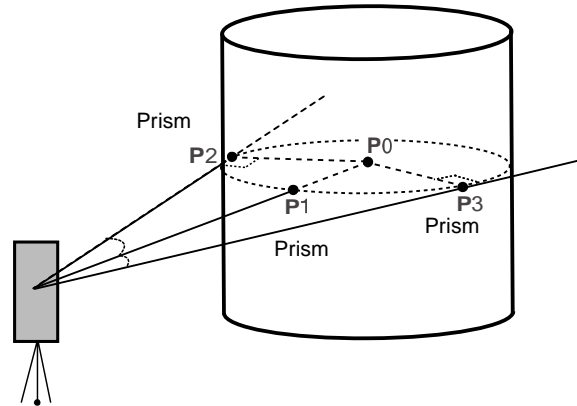

Operating procedure	Operation	Display
<p>1 Press [F6](MORE) key from programs menu to get to the next page of programs.</p> <p>2 Press [F4](OFFSET) key.</p> <p>3 Press [F4](COLUMN OFFSET) key.</p> <p>Measurement screen of the center of a column will be shown.</p> <p>4 Collimate the center of the column (P1) and press the [F1](MEAS) key. Measuring will start. After the measurement, angle measuring display of the left side (P2) will be shown.</p>	[F6]	<pre> Programs ----- F1 BS p 4/9 F2 STORE p F3 REM p F4 MLM p MORE </pre>
	[F4]	<pre> Programs ----- F1 REP p 8/9 F2 LAYOUT p F3 LINE p F4 OFFSET p MORE </pre>
	[F4]	<pre> OFFSET MEASUREMENT 1.ANGLE OFFSET 2.DIST. OFFSET 3.PLANE OFFSET 4.COLUMN OFFSET </pre>
	[F4]	<pre> COLUMN OFFSET Center HD : m MEAS HT </pre>
	Collimate P1 [F1]	<pre> COLUMN OFFSET Left HR : 90°30'40" SET </pre>

4 PROGRAM MODE

<p>5 Collimate the left side of the column (P2) and press the [F6](SET) key.</p> <p>After the measurement, angle measuring display of the right side (P3) will be shown.</p>	Collimate P2 [F6]	<div style="border: 1px solid black; padding: 5px;"> <p style="text-align: center;">COLUMN OFFSET</p> <p>Right</p> <p style="text-align: center;">HR : 95°30'40"</p> <p style="text-align: right;">SET</p> </div>
<p>6 Collimate the right side of the column (P3) and press the [F6](SET) key.</p> <p>After the measurement, the distance between the instrument and center of the column (P0) will be calculated and displayed.</p>	Collimate P3 [F6]	<div style="border: 1px solid black; padding: 5px;"> <p style="text-align: center;">COLUMN OFFSET</p> <p>HR: 90°30'40"</p> <p>HD: 10.321 m</p> <p>VD: 0.886 m</p> <p>NEXT SD NEZ REC</p> </div>
<p>7 To show the slope distance of point P0, press the [F2](SD) key.</p>	[F2]	<div style="border: 1px solid black; padding: 5px;"> <p style="text-align: center;">DIST. OFFSET</p> <p>V : 85°30'30"</p> <p>HR: 90°30'40"</p> <p>SD: 10.999 m</p> <p>NEXT HD NEZ REC</p> </div>
<p>8 To show the coordinates, press the [F3](NEZ) key. *1)</p>	[F3]	<div style="border: 1px solid black; padding: 5px;"> <p style="text-align: center;">DIST. OFFSET</p> <p>N : 17.321 m</p> <p>E : 10.962 m</p> <p>Z : 0.886 m</p> <p>NEXT SD HD REC</p> </div>
<p>*1) To repeat the offset measurement, press the [F1](NEXT) key. The display will return to step 4.</p>		

4.9 LOADER option

The loader option can load Application programs from a PC to the GTS-600 series. Before loading any application programs, make sure the communication parameters in the instrument match the parameters on the PC software. For further information about the parameters, refer to the application software manual.

Operating procedure	Operation	Display
<p>1 Press [F6](MORE) key twice from programs menu to get the next page of programs.</p> <p>2 Press [F3](LOADER) key. If the instrument and the PC are not connected the message will be shown as the right display. If you do not want to load the program, press the [F1](ESC) key.</p> <p>When the loading is completed, the display will return to the main menu icons.</p>	[F6] twice	<pre> Programs ----- F1 BS p 4/9 F2 STORE p F3 REM p F4 MLM p MORE </pre>
		<pre> Programs ----- F1 LOADER p MORE </pre>
	[F3]	<pre> Application Loader Waiting Connection... ESC </pre>
		<pre> Application Loader 9/9 Connected... </pre>
		<p>↓</p> <pre> GTS-600 series </pre> <p>↓</p> <p>Main menu</p>

5 MEMORY MANAGE MODE

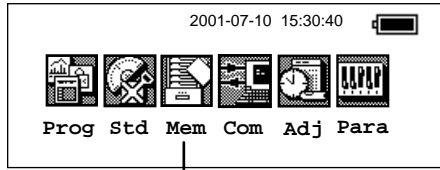

[Press [F3] key.]

MEMORY MANAGE MODE

The following items are available in this mode.

Normal model

1. Display File Memory Status
2. Protecting a File
3. Deleting a File
4. Renaming a File Name
5. Initializing Memory.

Card model

1. Display Internal Memory and Card Memory Status
2. Protecting a File
3. Deleting a File
4. Renaming a File Name
5. Copying a File
6. Initializing Internal Memory or Card Memory

5.1 View Internal Memory Status (for normal model)

The GTS-600 series will display the memory size, the amount of free memory and the expiration date for the internal lithium battery.

Operating procedure	Operation	Display
<p>The memory capacity and the remaining memory capacity are shown by pressing [F3](Mem) from Main Menu Icons.</p> <p>1 Press [F6](File) key. Each File status (File name, File name extension, Used memory capacity, Date) are shown.</p>	[F6]	<pre> Memory size 314KByte Memory free 236KByte Battery expire 2004-11 Init. File JIS .DAT 1597 12-25 TOPCON .DAT 1089 10-05 FC7 .TXT 2450 09-11 HILL .DAT 31777 08-19 Pro Ren Del ↓ ↑ </pre>

5.2 View Internal Memory and Card Memory Status (for Card model)

When selecting the internal memory or card memory, the GTS-600C series will display the memory size, the amount of free memory and the expiration date for the internal lithium battery. The display information format is the same for the card memory except that the card name appears at the top of the display and the battery expire does not appear. The card name can be alpha/numeric and up to 11 characters long.

Operating procedure	Operation	Display
<p>A menu will appear allowing you to select either the internal memory or card memory by pressing the [F3] key from the Main Menu Icons.</p>		<pre> Memory manage F1 Internal memory F2 Card memory </pre>

5 MEMORY MANAGE MODE

<p>1 Select Internal or Card memory by pressing [F1] or [F2]. Example: Internal memory The display shows the total memory size, the amount of memory free and the date when the lithium battery expire.</p>	[F1]	<pre>Memory size 314KByte Memory free 236KByte Battery expire 2006-06 Init. File</pre>
<p>2 Press [F6](File) key. The display will show all the files in the internal memory followed by the file extension, number of bytes and the date the file was created.</p>	[F6]	<pre>JIS .DAT 1597 12-25 TOPCON .DAT 1089 10-05 FC7 .TXT 2450 09-11 HILL .DAT 31777 08-19 Pro Ren Del Copy ↓ ↑</pre>
<p>● To return to the Main Menu Icons, press the [ESC] key.</p>		

5.3 Protecting a File

Protecting one or more files can be accomplished with the file protection mode. When a file is protected, an asterisk appears after the file name extension. If a file is protected, you can not delete the file unless you remove the file protection.

Note:All the files stored will be erased by initializing the memory, even if the files are protected.

Operating procedure	Operation	Display
<p>A menu will appear allowing you to select either the internal memory or card memory by pressing the [F3] key from the Main Menu Icons. (This menu is only for Card model.)</p>		<pre>Memory manage ----- F1 Internal memory F2 Card memory</pre>
<p>1 Select Internal or Card memory by pressing [F1] or [F2]. Example: Internal memory</p>	[F1]	<pre>Memory size 314KByte Memory free 236KByte Battery expire 2005-11 Init. File</pre>
<p>2 Press [F6](File) key.</p>	[F6]	<pre>JIS .DAT 1597 12-25 TOPCON .DAT 1089 10-05 FC7 .TXT 2450 09-11 HILL .DAT 31777 08-19 Pro Ren Del Copy ↓ ↑</pre>
<p>3 Select a file using the [F5](↑) key or [F6](↓) key.</p>	Select a file	
<p>4 Press the [F1](Pro) key.</p>	[F1]	<pre>Protect [TOPCON .DAT] ON OFF</pre>

<p>5 Press the [F5](ON) key. *1) The file is protected and display will return to file name. An asterisk “ * ” appears after the file extension to show that the file is protected.</p>	<p>[F5]</p>	<pre> JIS .DAT 1597 12-25 TOPCON .DAT * 1089 10-05 FC7 .TXT 2450 09-11 HILL .DAT 31777 08-19 Pro Ren Del Copy ↓ ↑ </pre>
<p>*1) When you cancel the protection, repeat the procedure above mentioned and select [F6](OFF) key.</p>		

5.4 Rename a File

Files can be renamed on the card or in internal memory. When renaming a file, the old file name appears above the input line for the new file name. When typing in the new name, you do not have to input the file extension.

Operating procedure	Operation	Display
<p>A menu will appear allowing you to select either the internal memory or card memory by pressing the [F3] key from the Main Menu Icons. (This menu is only for Card model.)</p>		<pre> Memory manage F1 Internal memory F2 Card memory </pre>
<p>1 Select Internal or Card memory by pressing [F1] or [F2]. Example: Internal memory</p>	<p>[F1]</p>	<pre> Memory size 314KByte Memory free 236KByte Battery expire 2005-11 Init. File </pre>
<p>2 Press [F6](File) key.</p>	<p>[F6]</p>	<pre> JIS .DAT 1597 12-25 TOPCON .DAT 1089 10-05 FC7 .TXT 2450 09-11 HILL .DAT 31777 08-19 Pro Ren Del Copy ↓ ↑ </pre>
<p>3 Select a file using [F5](↑) key or [F6](↓) key.</p>	<p>Select a file</p>	
<p>4 Press [F2](Ren) key.</p>	<p>[F2]</p>	<pre> Rename Old name [TOPCON .DAT] New name [] Alpha SPC <- -> </pre>
<p>5 Enter a new file name within 8 characters. Press [ENT] key.*1) File extensions are not necessary when typing the new name.</p>	<p>Enter name [ENT]</p>	
<p>*1) Refer to Section 2.9“How to Enter Numerals and Alphabet Letters”</p>		

5.5 Deleting a File

The delete mode erases a file from internal memory or the card memory. If a file is protected, the file can not be erased. File protection must be removed before you can delete a file. Only one file can be erased at a time.

Operating procedure	Operation	Display
A menu will appear allowing you to select either the internal memory or card memory by pressing the [F3] key from the Main Menu Icons. (This menu is only for Card model.)		<pre> Memory manage ----- F1 Internal memory F2 Card memory </pre>
1 Select Internal or Card memory by pressing [F1] or [F2]. Example: Internal memory	[F1]	<pre> Memory size 314KByte Memory free 236KByte Battery expire 2005-11 Init. File </pre>
2 Press [F6](File) key.	[F6]	<pre> JIS .DAT 1597 12-25 TOPCON .DAT 1089 10-05 FC7 .TXT 2450 09-11 HILL .DAT 31777 08-19 Pro Ren Del Copy ↓ ↑ </pre>
3 Select a file using [F5](↑) key or [F6](↓) key.	Select a file	
4 Press [F3](Del) key.	[F3]	<pre> Delete [TOPCON .DAT] YES NO </pre>
5 Confirm the file name, and press [F5](YES) key.	[F5]	
<p>● If the file is protected, the file can not be erased. Erase the file after canceling the protection.</p>		

5.6 Copying a File (only for Card model)

A file can be copied from internal memory to the card memory and vice versa. The copy mode only copies files to the root directory. Files can not be copied into other directories.

Operating procedure	Operation	Display
A menu will appear allowing you to select either the internal memory or card memory by pressing the [F3] key from the Main Menu icons.		<pre> Memory manage ----- F1 Internal memory F2 Card memory </pre>
1 Select Internal or Card memory by pressing [F1] or [F2]. Example: Internal memory	[F1]	<pre> Memory size 314KByte Memory free 236KByte Battery expire 2005-11 Init. File </pre>
2 Press [F6](File) key.	[F6]	<pre> JIS .DAT 1597 12-25 TOPCON .DAT 1089 10-05 FC7 .TXT 2450 09-11 HILL .DAT 31777 08-19 Pro Ren Del Copy ↓ ↑ </pre>
3 Select a file using [F5](↑) key or [F6](↓) key.	Select a file	
4 Press [F4](Copy) key.	[F4]	<pre> File copy [TOPCON .DAT] YES NO </pre>
5 Confirm the file name, and press [F5](YES) key.	[F5]	

5.7 Initializing Internal Memory or Card Memory

The initialize memory option will erase ALL FILES in either the internal memory or card memory and files cannot be retrieved.

Operating procedure	Operation	Display
<p>A menu will appear allowing you to select either the internal memory or card memory by pressing the [F3] key from the Main Menu Icons. (This menu is only for Card model.)</p>		<pre>Memory manage ----- F1 Internal memory F2 Card memory</pre>
<p>1 Select Internal or Card memory by pressing [F1] or [F2]. (This menu is only for Card model.) Example: Internal memory If card memory is selected, card name typing display will appear.</p>	[F1]	<pre>Memory size 314KByte Memory free 236KByte Battery expire 2005-11 Init. File</pre>
<p>2 Press [F1](Init) key.</p>	[F1]	<pre>Internal memory format YES NO</pre>
<p>3 Confirm the display, and press [F5](YES) key. Initializing will be executed. The display will return to main menu.</p>	[F5]	

6 COMMUNICATION MODE

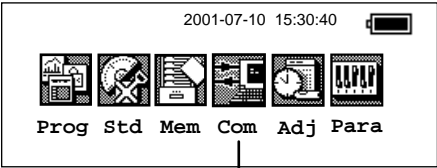

[Press [F4] key.]

COMMUNICATION MODES

The communication modes are used for setting the Baud rate (Protocol), receiving a file (Data file in) and sending a file (Data file out). A data transfer program on your PC that supports (YMODEM) will be necessary to send or receive data files.

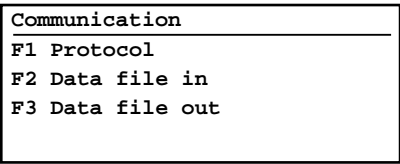

6.1 Setting of PROTOCOL

To transfer data files to and from the GTS-600 Series and a PC, the Baud rates must be the same. The Baud rate selections are 600, 1200, 2400, 4800, 9600, and 19200.

Operating procedure	Operation	Display
1 Press [F1](Protocol) key to set protocol.	[F1]	Communication F1 Protocol F2 Data file in F3 Data file out
		Communication Speed 600 1200 2400 4800 9600 19200 <- -> ↓ ↑
2 To select the Baud rate, use the arrow key's [F3-F6] to highlight your choice. When the correct Baud rate is highlighted, press the [ENT] key.	[F3] to [F6] [ENT]	Communication F1 Protocol F2 Data file in F3 Data file out

6.2 Data file in

You can transfer data files from a PC to the GTS-600 Series.

The file can be received into a sub-directory.

[Example] Transferring a file into [XYZ] sub-directory

Operating procedure	Operation	Display
<p>Make sure the instrument is ready and waiting for the data file before you command the PC to send the file.</p> <p>1 Press [F2](Data file in) key.</p> <p>2 Select a sub-directory by pressing the [F6](↓) or [F5](↑) key. Highlight will move up or down to select a sub-directory then press the [ENT] key. *1) Example : Selecting [XYZ] sub-directory</p> <p>3 Command the PC to send the file at this time. Press the [F1](START) key to start transferring. File name, amount of received data (Byte) / Capacity of the file (Byte) and percentage of proceeding will be displayed. When the transfer is complete, the display will return to the main menu icons.</p>	<p>[F2]</p> <p>[F5]or [F6] [ENT]</p> <p>[F1]</p>	<div data-bbox="933 451 1307 604" style="border: 1px solid black; padding: 2px;"> <p>Communication</p> <hr/> <p>F1 Protocol</p> <p>F2 Data file in</p> <p>F3 Data file out</p> </div> <div data-bbox="933 613 1307 766" style="border: 1px solid black; padding: 2px;"> <p>ABC <dir>01-04</p> <p>XYZ <dir>01-04</p> <hr/> <p>START MkDir ↓ ↑</p> </div> <div data-bbox="933 774 1307 928" style="border: 1px solid black; padding: 2px;"> <p>. <dir>01-04</p> <p>.. <dir>01-04</p> <hr/> <p>START MkDir ↓ ↑</p> </div> <div data-bbox="933 936 1307 1092" style="border: 1px solid black; padding: 2px;"> <p>Data file in</p> <hr/> <p>[TOPCON .DAT]</p> <p>0/ 8676 (0%)</p> </div>
<p>*1) To return to the main directory, select the “. .” directory and press the [ENT] key.</p> <ul style="list-style-type: none"> ● To make a sub-directory, press the [F4] (MkDir) key and enter new sub-directory name. Maximum eight letters can be input. See Section 2.9“How to Enter Numerals and Alphabet Letters”. ● Maximum 128 sub-directories can be generated. 		<div data-bbox="933 1239 1307 1392" style="border: 1px solid black; padding: 2px;"> <p>Make directory</p> <p>[]</p> <p>Alpha SPC ← →</p> </div>

6.3 Data file out

Tr ansferring a file from the GTS-600 internal memory to a PC is also possible.
 You can select two or more files in internal memory and send them to a PC at the same time.
 [Example] Sending two files (JIS.DAT and TOPCON. DAT)

Operating procedure	Operation	Display
Make sure the PC is ready and waiting before the GTS-600 sends the file.		<pre> Communication ----- F1 Protocol F2 Data file in F3 Data file out </pre>
1 Press [F3](Data file out) key.	[F3]	<pre> JIS .DAT 1597 12-25 TOPCON .DAT 1089 10-05 FC7 .TXT 2450 09-11 HILL .DAT 31777 08-19 ----- ALL SEL ↓ ↑ </pre>
2 Select a file by pressing [F5](↑) or [F6](↓) key and press the [F4](SEL) key. The mark ">" will appear on the left of the selected file. *1),2)	[F5]or [F6] [F4]	<pre> >JIS .DAT 1597 12-25 >TOPCON .DAT 1089 10-05 FC7 .TXT 2450 09-11 HILL .DAT 31777 08-19 ----- ALL SEL ↓ ↑ </pre>
3 Press the [ENT] key to start transferring. *3) File name, amount of sent data(Byte) / Capacity of the file (Byte) and percentage of proceeding will be displayed.	[ENT]	<pre> Data file out ----- [JIS .DAT] 0/ 1557 (0%) : : : </pre>
Each file selected will be transferred in order.		<pre> Data file out ----- [TOPCON .DAT] 0/ 1089 (0%) </pre>
When the transfer is complete, the display will return to the file menu.		
<p>*1) To release the selection, press the [F4](SEL) key again. *2) To select all files, press the [F3](ALL) key. To release the selection, press the [F3](ALL) key again. *3) Press the [ENT] key when no file is selected, hilight file will be transferred.</p>		

7 PARAMETERS SETTING MODE

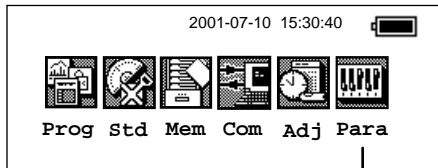

[Press [F6] key.]

PARAMETERS SETTING MODE

In this mode, setting of parameters regard with measuring, displaying and communications will be done.

When a parameter is changed and set, the new value is stored into memory. Press [F6] key from the main menu icons, the following display will be shown.

The parameter modes is classified in Measurement and Communication.

Parameters
F1 Measurement
F2 Communication
F3 Password

7.1 Parameter Setting Options

7.1.1 Parameters for Measurement and Display

Menu	Selecting Item	Contents
1.Ang. Unit	deg / gon / mil	Select degree(360°), gon(400G) or mil (6400M) for the measuring angle unit to be shown on the display .
2.Min.Angle	OFF / ON	Select the minimum display angle reading ON or OFF. GTS-601 series [OFF:1"/ ON:0.5"](0.5mgon/0.1mgon) GTS-602 series [OFF:5"/ ON:1"] (1mgon/0.2mgon) GTS-603 series [OFF:5"/ ON:1"] (1mgon/0.2mgon) GTS-605 series [OFF:5"/ ON:1"] (1mgon/0.2mgon)
3.Tilt	OFF / 1axis / 2axis	Select the tilt sensor option for OFF, (1axis) vertical only or (2axis) vertical and horizontal.
4.Err. corr.	OFF / ON	Select the error correction ON or OFF for collimation and error adjustment. Note: Perform this item after complete section 8.4 . For more information, refer to Section 8.4"Adjustment of Compensation Systematic Error of Instrument" and Section 8.5"Showing Constant List and Switch ON/ OFF Compensation Systematic Error of Instrument"
5.V -0	Zenith / Level	Select the vertical angle reading for Zenith 0 or Horizontal 0.
6.HAmem	OFF / MEM.ON	It is able to retain presetting angle after turning power off.(MEM.ON) Note: After changing this parameter, turn the power switch off once.
7.Light	OFF / ON	Select the option to turn on the backlight when the power is turned on. Note: Resume Mode ON/OFF option is given priority to regardless of the setting of this item.

7 PARAMETERS SETTING MODE

8.Dist. Unit	meter/feet	Select the distance measuring unit Meter or Feet shown on the display.
9.C.F. m/ft	Us.f /Intl.f	Select the meter / feet conversion factor. US survey feet 1m=3.280833333333333 ft. International feet 1m=3.280839895013123 ft.
10.Min. Dist.	OFF / ON	Select OFF or ON for the minimum distance in fine mode. OFF:1mm :ON: 0.2mm
11.S/A b uzz.	OFF / ON	Select the Audio tone OFF or ON for the Set Audio Mode.
12.W-corr.	OFF/ 0.14 / 0.20	Select the coefficient correction for refraction and earth curvature. Selections for the refraction coefficient are; OFF (No correction), K=0.14 or K=0.20.
13.NE/Z mem	OFF / MEM.ON	Select the option to store the coordinates (NEZ) for the occupied point when power is turned off..
14.N/E- ord.	NEZ / ENZ	Select the display format in the coordinate measurement mode for NEZ or ENZ.
15.Temp. Unit	°C / °F	Select the temperature unit for the atmospheric correction.
16.Pres. Unit	mmHg/inHg/hPa	Select the air pressure unit for the atmospheric correction .
17.R/L Lock	OFF / ON	Prohibit switching angle right or left by soft key in angle measurement mode OFF : Switching is possible ON : Prohibition
18.m/ft Lock	OFF / ON	Prohibit switching meter unit or feet unit. OFF : Switching is possible ON : Prohibition
19.Date	m/d/y d/m/y y/m/d	Select the date format shown on the display. (Month/Date/Year), (Date/ Month/Year) or (Year / Month / Date)
20.A. P. OFF	OFF / ON (01 to 99)	The auto power off function can be turned OFF or set ON. OFF : not use ON :1 to 99 minutes (numeric key)
21.Heater	OFF / ON	The heater option for both display units can be turned OFF or ON.
22.EDM wait	OFF / ON (01 to 99)	EDM cut off time after distance measurement is completed can be changed. OFF : EDM is cut off immediately after measuring ON : EDM is cut off after 1 to 99 minutes. (numeric key)
23.L.P.OFF (Only for Laser plummet type)	manual / auto 01 to 99	Laser Plummet function can be turned OFF automatically. manual ON/OFF by pressing soft key. auto 01~99 : Laser Plummet function is cut off after 1 to 99 minutes. (numeric key)

7 PARAMETERS SETTING MODE

7.1.2 Parameters for communication

Factory default settings are indicated with underlines.

Menu	Selecting Item	Contents
1.B. Rate	<u>1200</u> / 2400 / 4800 / 9600	Select the baud rate.
2.Data. L	<u>7</u> / 8	Select the data length seven digits or eight digits.
3.Parity	none / odd / <u>even</u>	Select the parity bit.
4.Stop Bit	<u>1</u> / 2	Select the stop bit.
5.Delimit	<u>ETX</u> / CRLF	Select the option OFF or ON for carriage return and line feed when collecting measurement data with a computer.
6.REC-A/B	<u>A</u> / B	Select the option to record the data. REC-A : The measurement is started and new data is output. REC-B : The data being displayed is output.
7.Protocol	OFF / <u>ON</u>	When communicating to an external device, the protocol for handshaking can omit the [ACK] coming from the external device so data is not sent again. OFF : Omit the [ACK] ON : Standard
8.NEZ-REC	<u>Std</u> / Exp	Record coordinates in standard or Data with slope distance and horizontal angle data.

7.2 Setting Parameters

7.2.1 Parameters for Measurement and Display

[Example setting] S/A BUZZER: OFF , Atmospheric pressure: hPa

Operating procedure	Operation	Display
1 From the main menu icons, press [F6](Para) to access the parameters option menu.	[F6]	<pre>Parameters ----- F1 Measurement F2 Communication F3 Password</pre>
2 Press the [F1] (Measurement) key.	[F1]	<pre>Parameters (Measurement) ----- Ang.Unit [_deg_] gon mil Min.Angle OFF [_ON_] Tilt OFF laxis [2axis] SET EXIT <- -> ↓ ↑</pre>
3 Select the menu by pressing [F6](↓) key. (Example:S/A buzz.)	[F6]	<pre>Parameters (Measurement) ----- S/A buzz. OFF [_ON_] W-corr. OFF [_0.14_] 0.20 N/E/Z mem OFF [MEM.ON] SET EXIT <- -> ↓ ↑</pre>
4 Press [F3](←) key, and select OFF .	[F3]	<pre>Parameters (Measurement) ----- S/A buzz. [_OFF_] ON W-corr. OFF [_0.14_] 0.20 N/E/Z mem OFF [MEM.ON] SET EXIT <- -> ↓ ↑</pre>
5 Select the atmospheric pressure menu by pressing [F6](↓) key.	[F6]	<pre>Parameters (Measurement) ----- Pres.Unit [_mmHg_] inHg hPa R/L Lock [_OFF_] ON m/ftLock [_OFF_] ON SET EXIT <- -> ↓ ↑</pre>
6 Press [F4](→) key, and select [hPa].	[F3]	<pre>Parameters (Measurement) ----- Pres.Uni mmHg inHg [hPa_] R/L Lock [_OFF_] ON m/ftLock [_OFF_] ON SET EXIT <- -> ↓ ↑</pre>
7 Press [F1](SET) key.	[F1]	<pre>Parameters (Measurement) ----- > Set OK? YES NO</pre>
8 Press [F5](YES) key. *1) The display returns main menu.	[F5]	
*1) To cancel the setting, press [F6](NO) key.		

7.2.2 Parameters for communication

Operating procedure	Operation	Display
<p>1 From the main menu icons, press [F6](Para) to access the parameters option menu.</p>	<p>[F6]</p>	<pre>Parameters ----- F1 Measurement F2 Communication F3 Password</pre>
<p>2 Press the [F2] (Communication) key.</p>	<p>[F2]</p>	<pre>Parameters (Communication) ----- B.Rate [1200] 2400 4800 9600 Data.L [7] 8 Parity none odd [even] SET I.GTS <- -> ↓ ↑</pre>
<p>3 The next steps are same as Section 7.2.1"Parameters for Measurement and Display" , refer to the section 7.2.1. *1)</p>		
<p>*1) Press the [F2](I.GTS) key to reset to the factory default settings (Topcon total station current fixed protocol). Factory default settings are indicated with underlines in Section 7.1.2"Parameters for communication" .</p>		

7.2.3 Password option

Establishing a Password

A password can be set in the GTS-600 series to secure the use of the instrument. Once a password is established the user can disable the option or change the password. Once a password established and the option is turned off, the password will always remain in memory. When turning on the instrument after a password-input screen appears before the self-testmode. Type in your password and press the [ENTER] to continue.

A maximum of 10 numeric digits can be entered for a password. All zeros (0000000000) or 9's (9999999999) are invalid passwords. If 10 unsuccessful attempts are made to input a password, the instrument will shut off automatically.

Establishing a Password for the first time.

The instructions below show how to establish a password for the first time.

Operating procedure	Operation	Display
<p>1 From the main menu icons, press [F6](Para) to access the parameters option menu. To access the password option, press [F3](Password).</p>	[F6]	<pre>Parameters ----- F1 Measurement F2 Communication F3 Password</pre>
<p>2 The password option screen will appear. When accessing the password option for the first time, the [OFF] indicator will appear on the upper left corner of the screen. To establish a password you can press the [F5](ON) key to turn on the option and establish a password.</p>	[F3]	<pre>Password [OFF] EXIT CHANGE ON OFF</pre>
<p>3 The password-input screen will appear. At the blinking cursor type in your password and press the [ENT] key.</p> <p>IMPORTANT: DON'T FORGET YOUR PASSWORD. WRITE THE PASSWORD DOWN ON A PIECE OF PAPER AND PUT IN A SAFE PLACE. ONCE A PASSWORD IS STORED YOU CAN NOT ERASE IT FROM MEMORY.</p>	[F5]	<pre>Password Input a password [] EXIT BS</pre>
	Type password [ENT]	<pre>Password Input again (confirmation) [] EXIT BS</pre>
<p>4 The confirmation screen will appear to confirm your password. Type the password in once again and press [ENTER].</p>	Type password [ENT]	<pre>Password [ON] EXIT CHANGE ON OFF</pre>
<p>5 The password option screen will appear once again for 2 seconds and will automatically change to the main menu icons. Notice the [ON] indicator is now shown on the display.</p>		

7 PARAMETERS SETTING MODE

Turning OFF the Password

After a password is established, you can disable the password option. Once you disable the option, the password-input screen will not appear every time you power on the instrument.

Turning OFF the Password Option

Operating procedure	Operation	Display
1 From the main menu icons, press [F6](Para) to access the parameters option menu. Press [F3](Password) to access the password option.	[F6]	<pre>Parameters ----- F1 Measurement F2 Communication F3 Password</pre>
	[F3]	<pre>Password ----- Input a password [] EXIT BS</pre>
2 Type in your password and press [ENT].	Type password [ENT]	
3 The password option screen will appear. The indicator on the upper left side of the screen will show [ON].		<pre>Password [ON] EXIT CHANGE ON OFF</pre>
4 To turn off the password option, press [F6](OFF). The [ON] indication changes to [OFF] and the screen automatically changes back to the main menu icons.	[F6]	<pre>Password [OFF] EXIT CHANGE ON OFF</pre>

7 PARAMETERS SETTING MODE

Changing a Password

Once a password is established, you can change the original password. The new password takes the place of the original password in memory.

Changing the Password

Operating procedure	Operation	Display
1 From the main menu icons, press [F6](Para) to access the parameters option menu. Press [F3](Password) to access the password option.	[F6]	<pre>Parameters ----- F1 Measurement F2 Communication F3 Password</pre>
	[F3]	<pre>Password ----- Input a password [] EXIT BS</pre>
2 Type in your password at the blinking cursor and press [ENT].	Type password [ENT]	
3 The password option screen will appear. Press the [F2](Change) to change the current password.	[F2]	<pre>Password ----- [ON] EXIT CHANGE ON OFF</pre>
	[F2]	<pre>Password ----- Input a password [] EXIT BS</pre>
4 The password-input screen will appear. At the blinking cursor type in the new password and press the [ENT] key. IMPORTANT: DON'T FORGET YOUR PASSWORD.	Type password [ENT]	<pre>Password ----- Input again (confirmation) [] EXIT BS</pre>
5 The confirmation screen will appear to confirm your new password. Type in the new password once again and press [ENT].	Type password [ENT]	<pre>Password ----- [ON] EXIT CHANGE ON OFF</pre>
6 The password option screen will appear once again. Press the [F1](EXIT) to return back to the main menu icons.	[F1]	

8 CHECK AND ADJUSTMENT

8.1 Checking and adjusting of instrument constant

Normally, the instrument constant does not have discrepancy. It is recommended you measure and compare with an accurately measured distance at a location where the precision is specifically monitored on a consistent basis. If such a location is not available, establish your own base line over 20m (when purchasing the instrument) and compare the data measured with the newly purchased instrument.

In both cases note that the setup displacement of the instrument position over the point, the prism, baseline precision, poor collimation, atmospheric correction, and correction for refraction and earth curvature determine the inspection precision. Please keep in mind these points.

Also, when providing a base line in a building, please note that differences in temperature greatly affect the length measured.

If a difference of 5mm or over is the result from the comparative measurement, the following procedure as shown below could be used to change the instrument constant.

- 1) Provide point C on a straight line, connecting straight line AB which is almost level and about 100m long. Measure straight lines AB, AC and BC.

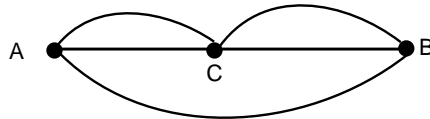

- 2) Obtain the instrument constant by repeating 1) above several times.
Instrument constant = $AC + BC - AB$
- 3) When there is error between written instrument constant value and calculated value, review the Section 8.7-How to Set the Instrument Constant Value procedure.
- 4) Once again, measure at a calibrated baseline and compare with the instrument base line the length.
- 5) If using above procedure and no difference is found from the instrument constant at the factory or a difference of over 5mm is found, contact TOPCON or your TOPCON dealer.

Note: To check and adjust of Auto-Focus (For Automatic Focussing model), see Section 1.7"Automatic Focusing (Only for Automatic Focusing model)" .

8.2 Checking the Optical Axis

To check if the optical axis of EDM and theodolite are matched, follow the procedure below. It is especially important to check after adjustment of the eyepiece reticle is carried out.

- 1) Position the Instrument and prism with about 2m apart and face them at each other.
(At this time, the power is ON.)

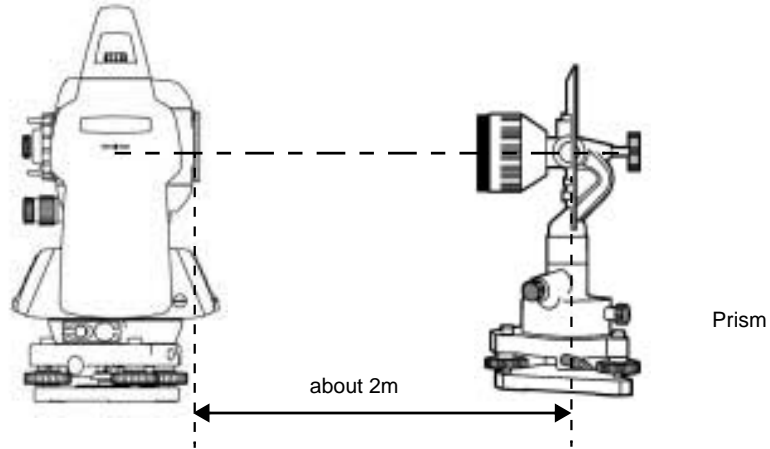

- 2) Sight through the eyepiece and focus to the prism. Then center the prism on the cross hairs.

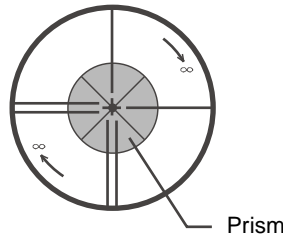

- 3) Set to the measure mode to distance measurement or set audio.
- 4) Sight through the eyepiece and focus the (blinking) red light spot by turning the focusing knob in the direction of infinity (clockwise). If displacement of the reticle cross hairs is within one-fifth of the diameter of the round red light spot both vertically and horizontally, adjustment will not be required.

Note: If displacement is more than one-fifth in the above case, and still remains so after rechecking the original line of sight, the instrument must be adjusted by competent technicians. Please contact TOPCON or your TOPCON dealer to adjust the instrument.

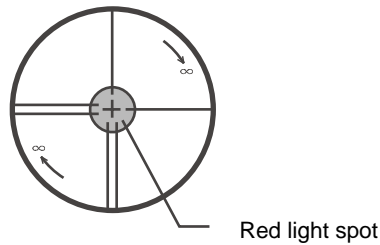

Note: For checking the optical axis of Automatic Focusing model, please contact Topcon or your Topcon dealer.

8.3 Checking/Adjusting the Theodolite Functions

•Pointers on the Adjustment

- 1) Adjust the eyepiece of the telescope properly prior to any checking operation which involves sighting through the telescope.
Remember to focus properly, with parallax completely eliminated.
- 2) Carry out the adjustments in the order of item numbers, as the adjustments are dependent one upon another. Adjustments carried out in the wrong sequence may even nullify previous adjustment.
- 3) Always conclude adjustments by tightening the adjustment screws securely (but do not tighten them more than necessary, as you may strip the threads, twist off the screw or place undue stress on the parts).
Furthermore, always tighten by revolving in the direction of tightening tension.
- 4) The attachment screws must also be tightened sufficiently, upon completion of adjustments.
- 5) Always repeat checking operations after adjustments are made, in order to confirm results.

•Notes on the Tribrach

Note that the angle measuring precision may be effected directly if the tribrach has not been installed firmly.

- 1) If any leveling screw becomes loose and slack or if collimation is unstable due to the looseness of leveling screws, adjust by tightening the adjusting screws (in 2 places) installed over each leveling screw with a screwdriver
- 2) If there is any slack between the leveling screws and the base, loosen the set screw of the holding ring and tighten the holding ring with adjusting pin, until it is properly adjusted. Re-tighten the set screw on completing the adjustment.

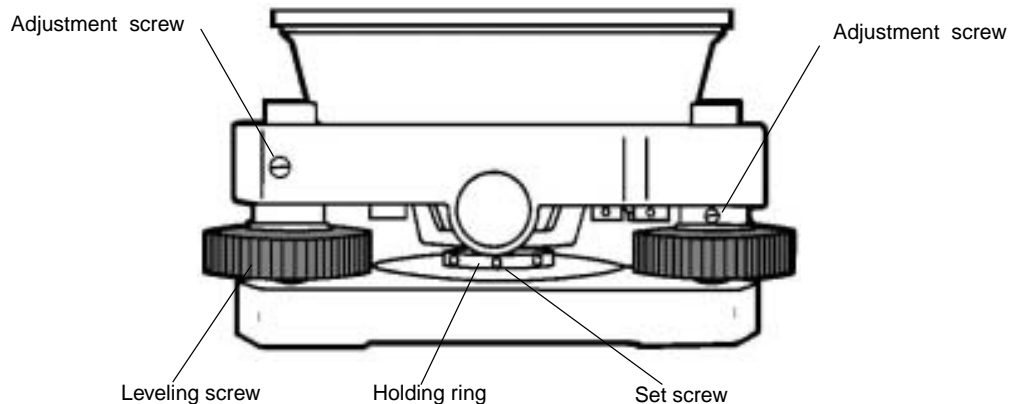

8.3.1 Checking /Adjusting the Plate Level

Adjustment is required if the axis of the plate level is not perpendicular to the vertical axis.

• **Check**

- 1) Place the plate level parallel to a line running through the centers of two leveling screws, say, A and B. Use these two leveling screws only and place the bubble in the center of the plate level.
- 2) Rotate the instrument 180° or 200g around the vertical axis and check bubble movement of the plate level. If the bubble has been displaced, then proceed with the following adjustment.

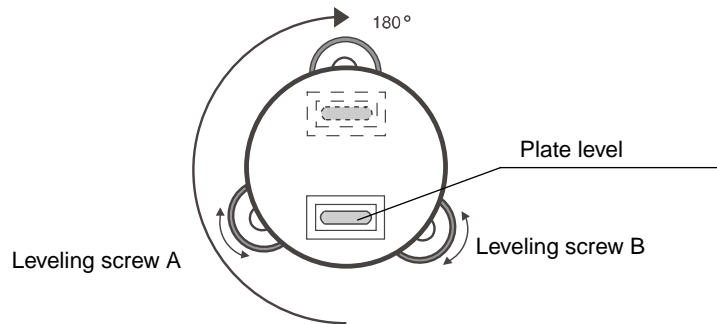

• **Adjustment**

- 1) Adjust the level adjustment capstan screw, with the accessory adjusting pin and return the bubble towards the center of the plate level. Correct only one-half of the displacement by this method.
- 2) Correct the remaining amount of the bubble displacement with the leveling screws.
- 3) Rotate the instrument 180° or 200g around the vertical axis once more and check bubble movement. If the bubble is still displaced, then repeat the adjustment.

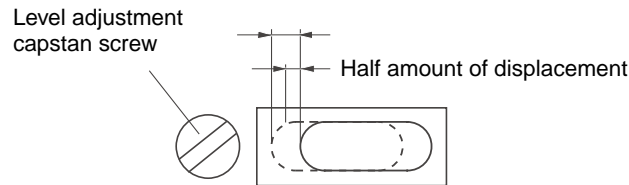

8.3.2 Checking /Adjusting the Circular Level

Adjustment is required if the axis of the circular level is also not perpendicular to the vertical axis.

• **Check**

- 1) Carefully level the instrument with the plate level only. If the bubble of the circular level is centered properly, adjustment is not required. Otherwise, proceed with the following adjustment.

• **Adjustment**

- 1) Shift the bubble to the center of the circular level, by adjusting three capstan adjustment screws on the bottom surface of the circular level, with the accessory adjusting pin.

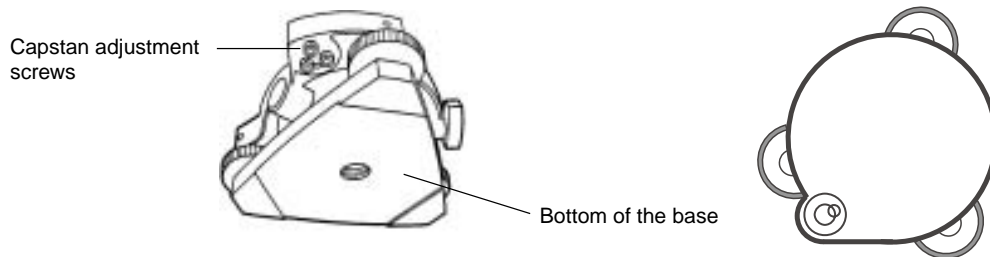

8.3.3 Adjustment of the Vertical Cross-hair

Adjustment is required if the vertical cross-hair is not in a plane perpendicular to the horizontal axis of the telescope (since it must be possible to use any point on the hair for measuring horizontal angles or running lines).

•Check

- 1) Set the instrument up the tripod and carefully level it.
- 2) Sight the cross-hairs on a well defined Point A at a distance of, at least, 50 meters (160ft.) and clamp horizontal motion.
- 3) Next swing the telescope vertically using the vertical tangent screw, and check whether the point travels along the length of the vertical cross-hair.
- 4) If the point appears to move continuously on the hair, the vertical cross-hair lies in a plane perpendicular to the horizontal axis (and adjustment is not required).
- 5) However, if the point appears to be displaced from the vertical cross-hair, as the telescope is swung vertically, then proceed with the following adjustment.

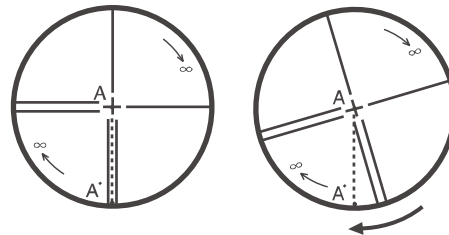

•Adjustment

- 1) Unscrew the cross-hair adjustment section cover, by revolving it in the counterclockwise direction, and take it off. This will expose four eyepiece section attachment screws.

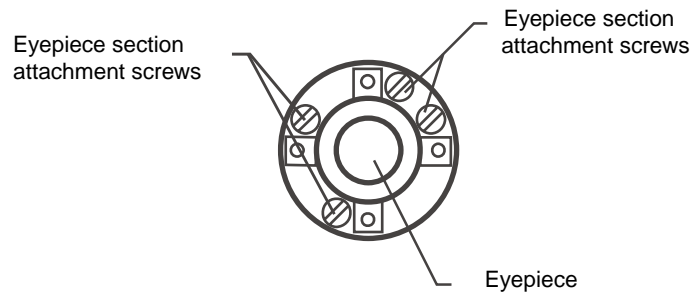

- 2) Loosen all four attachment screws slightly with the accessory screw-drive (while taking note of the number of revolutions).
Then revolve the eyepiece section so that the vertical cross-hair coincides to Point A'.
Finally, re-tighten the four screws by the amount that they were loosened.
- 3) Check once more and if the point travels the entire length of the vertical cross-hair, further adjustment is not required.

Note: Perform following adjustment after completing the above adjustment .
Chapter 8.3.4 "Collimation of the Instrument", Chapter 8.4 "Adjustment of Compensation Systematic Error of Instrument" .

8 CHECK AND ADJUSTMENT

8.3.4 Collimation of the Instrument

Collimation is required to make the line of sight of the telescope perpendicular to the horizontal axis of the instrument, otherwise, it will not be possible to extend a straight line by direct means.

•Check

- 1) Set the instrument up with clear sights of about 50 to 60 meters (160 to 200 ft.) on both sides of the instrument.
- 2) Level the instrument properly with the plate level.
- 3) Sight Point A at approximately 50 meters (160 ft.) distance.
- 4) Loosen the vertical motion clamp only, and rotate the telescope 180° or 200g around the horizontal axis, so that the telescope is pointed in the opposite direction.
- 5) Sight Point B, at equal distance as Point A and tighten the vertical motion clamp.
- 6) Loosen the horizontal motion clamp and rotate the instrument 180° or 200g around the vertical axis. Fix a sight on Point A once more and tighten the horizontal motion clamp.
- 7) Loosen the vertical motion clamp only and rotate the telescope 180° or 200g around the horizontal axis once more and fix a sight on Point C, which should coincide with previous Point B.
- 8) If Points B and C do not coincide, adjust in the following manner.

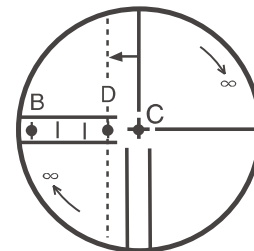
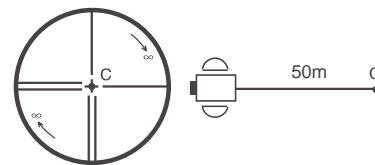
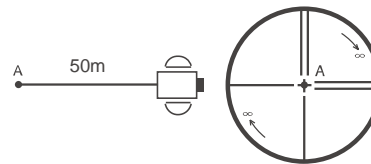
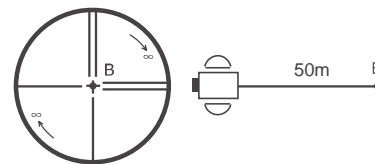
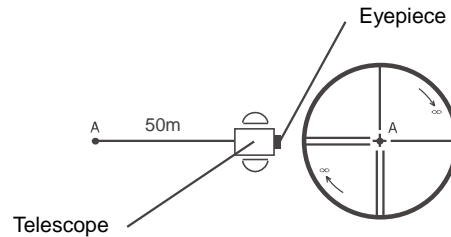

•Adjustment

- 1) Unscrew the cross-hair adjustment section cover.
- 2) Find Point D at a point between Points C and B, which should be equal to 1/4th the distance between Points B and C and measured from Point C. This is because the apparent error between Points B and C is four times the actual error since the telescope has been reversed twice during the checking operation.

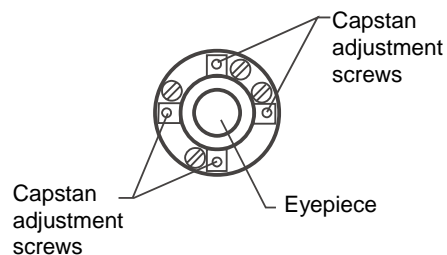

- 3) Shift the vertical cross-hair line and coincide it with Point D, by revolving the left and right capstan adjustment screws with the adjusting pin. Upon completing the adjustment, repeat the checking operation once more.
If Points B and C coincide, further adjustment is not required. Otherwise, repeat the adjustment.

Note:

- 1 First, loosen the capstan adjustment screw on the side to which the vertical cross-hair line must be moved. Then tighten the adjustment screw on the opposite side by an equal amount which will leave the tension of the adjustment screws unchanged. Revolve in the counterclockwise direction to loosen and in the clockwise direction to tighten, but revolve as little as possible.
- 2 Perform following adjustment after complete above adjustment . Chapter 8.4 "Adjustment of Compensation Systematic Error of Instrument", Chapter 8.2 "Checking the Optical Axis".

8.3.5 Checking / Adjusting the Optical Plummet Telescope

Adjustment is required to make the line of sight of the optical plummet telescope coincide with the vertical axis (otherwise the vertical axis will not be in the true vertical when the instrument is optically plumbed).

•Check

- 1) Coincide the center mark and the point. (See Chapter 2 "PREPARATION FOR MEASUREMENT".)
- 2) Rotate the instrument 180° or 200g around the vertical axis and check the center mark. If the point is properly centered in the center mark, adjustment is not required. Otherwise, adjust in the following manner.

•Adjustment

- 1) Take off the adjustment section cover of the optical plummet telescope eyepiece. This will expose four capstan adjustment screws which should be adjusted with the accessory adjusting pin to shift the center mark to the point. However, correct only one-half of the displacement in this manner.

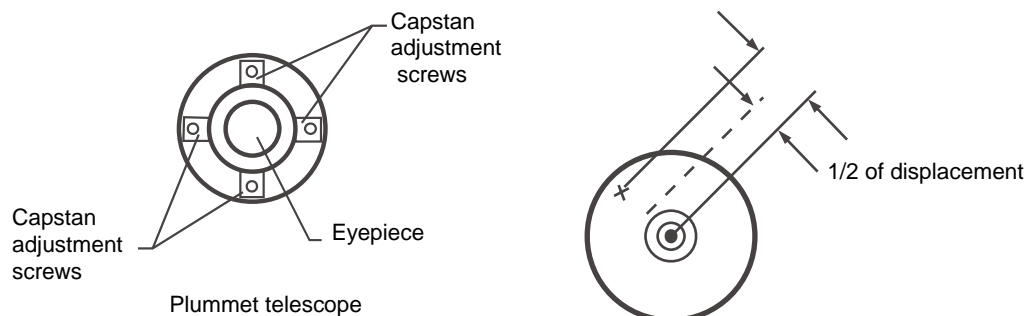

- 2) Use the leveling screws and coincide the point and center mark.
- 3) Rotate the instrument 180° or 200g around the vertical axis once more and check the center mark. If it is coincided to the point, then further adjustment is not required. Otherwise, repeat the adjustment.

Note: First, loosen the capstan adjustment screw on the side to which the center mark must be moved. Then tighten the adjustment screw on the opposite side by an equal amount which will leave the tension of the adjustment screws unchanged. Revolve in the counterclockwise direction to loosen and in the clockwise direction to tighten, but revolve as little as possible.

8.3.6 Checking / Adjusting the Laser Plummet (For Laser Plummet type)

•Check

- 1) Turn on the laser plummet and coincide the center of the laser with a measuring point.
- 2) Rotate the instrument 180° or 200g around the vertical axis and check the measuring point.
If the laser is properly centered in the measuring point, adjustment is not required. Otherwise, adjust in the following manner.

•Adjustment

- 1) Turn the cap located on the left side corner of the instrument counterclockwise and remove it. This will expose four adjustment screws which should be adjusted with the accessory hexagonal wrench.
- 2) Shift the laser to the measuring point. However, correct only one-half of the displacement in this manner.

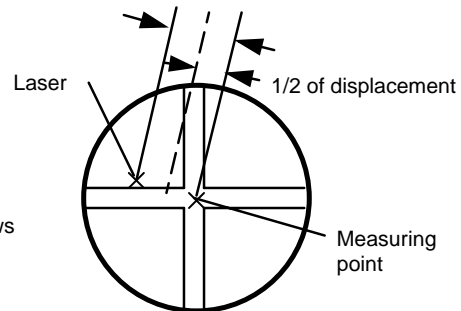
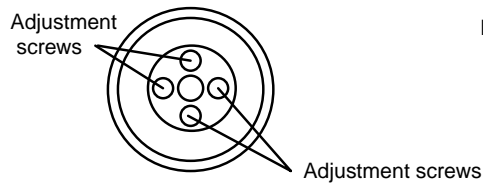
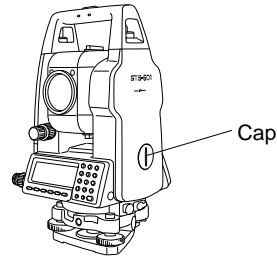

- 3) Use the leveling screws and coincide the center of the laser and the point.
- 4) Rotate the instrument 180° or 200g around the vertical axis once more and check the point and the laser. If the laser is coincided to the measuring point, then further adjustment is not required. Otherwise, repeat the adjustment.

Note: First, loosen the adjustment screw to move the laser. Then tighten the adjustment screw on the opposite side by an equal amount which will leave the tension of the adjustment screws unchanged. Revolve in the counterclockwise direction to loosen and in the clockwise direction to tighten, but revolve as little as possible.

Reference

The laser can be moved by turning the adjustment screws clockwise as follows.

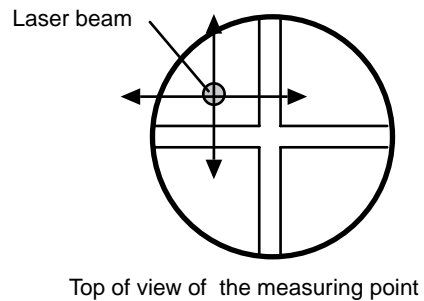
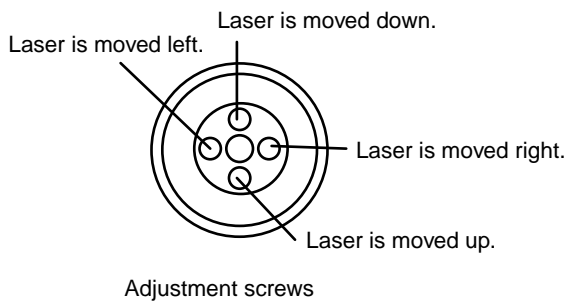

8.4 Adjustment of Compensation Systematic Error of Instrument

- 1) Error of vertical axis (X,Y tilt sensor offset)
- 2) Collimation error
- 3) Error of vertical angle 0 datum
- 4) Error of horizontal axis

The above mentioned errors will be compensated by software, which calculated internally according to each compensation value.

Also these errors can be compensated by software collimating one side of the telescope that is carried out to delete the error by turning in normal and reverse both sides of telescope so far.

Operating procedure	Operation	Display
1 Level the instrument properly with the plate level.		
2 Press [F5] key from the main menu.	[F5]	<div style="border: 1px solid black; padding: 5px;"> F1 V0/Axis (Measurement) F2 V0/Axis (Constant list) F3 Date Time F4 Instrument constant ↓ </div>
3 Press [F1] key .	[F1]	<div style="border: 1px solid black; padding: 5px; text-align: center;"> [V0/Axis Adjustments] </div> <p style="text-align: center;">↓</p> <div style="border: 1px solid black; padding: 5px;"> ERROR CORRECTION (A) Tilt,V0 init,Collimation (B) H Axis </div> <p style="text-align: center;">↓</p> <div style="border: 1px solid black; padding: 5px; text-align: center;"> (A) COLLIMATION </div> <p style="text-align: center;">↓</p>
Adjustment		
4 Collimate target A (around 0° in horizontal within ±3°) in normal telescope setting (FACE(1)).	Collimate A (Normal)	<div style="border: 1px solid black; padding: 5px;"> <div style="display: flex; justify-content: space-between;"> LEVEL±0 FACE 1 /0 </div> <p style="text-align: center;">V: 88°40'20"</p> <div style="display: flex; justify-content: space-between;"> SKIP SET </div> </div>
5 Press [F6](SET)key. *1) The sample display shows that the measurement is made 5 times in FACE 1.	[F6]	<div style="border: 1px solid black; padding: 5px;"> <div style="display: flex; justify-content: space-between;"> LEVEL±0 FACE 1 /5 </div> <p style="text-align: center;">V: 89°55'50"</p> <div style="display: flex; justify-content: space-between;"> SKIP SET </div> </div>
6 Turn the telescope in reverse telescope setting (FACE(2)).	Turn telescope	<div style="border: 1px solid black; padding: 5px;"> <div style="display: flex; justify-content: space-between;"> LEVEL±0 FACE 2 0/5 </div> <p style="text-align: center;">V: 270°04'20"</p> <div style="display: flex; justify-content: space-between;"> SKIP SET </div> </div>

8 CHECK AND ADJUSTMENT

<p>7 Collimate target A.</p> <p>8 Press [F6](SET)key. Repeat the procedures in step 7 and 8 so that the count of measured times matches to the one in FACE(1). * 2),3),4)</p> <p style="padding-left: 20px;">The title display will be shown automatically.</p>	<p>Collimate A (Reverse)</p> <p>[F6]</p>	<div style="border: 1px solid black; padding: 5px; margin-bottom: 5px;"> <div style="display: flex; justify-content: space-between; align-items: center;"> LEVEL±0 FACE 2 5/5 </div> <p style="text-align: center;">V: 270°04' 20"</p> <div style="display: flex; justify-content: space-between;"> SKIP SET </div> </div> <p style="text-align: center;">↓</p> <div style="border: 1px solid black; padding: 10px; text-align: center; margin-bottom: 5px;"> <p>(B)HORIZONTAL Axis</p> </div> <p style="text-align: center;">↓</p> <div style="border: 1px solid black; padding: 5px;"> <div style="display: flex; justify-content: space-between; align-items: center;"> LEVEL±10° FACE 2 /0 </div> <p style="text-align: center;">V: 270°04' 20"</p> <div style="display: flex; justify-content: space-between;"> SKIP SET </div> </div>
<p>9 Collimate target B (more than ±10° from the level) in reverse telescope setting (FACE(2)). *5)</p> <p>10 Press [F6](SET)key. *1)</p>	<p>Collimate B (Reverse)</p> <p>[F6]</p>	<div style="border: 1px solid black; padding: 5px; margin-bottom: 5px;"> <div style="display: flex; justify-content: space-between; align-items: center;"> LEVEL±10° FACE 2 /5 </div> <p style="text-align: center;">V: 270°04' 20"</p> <div style="display: flex; justify-content: space-between;"> SKIP SET </div> </div>
<p>11 Turn the telescope in normal telescope setting(FACE(1)).</p>	<p>Turn telescope</p>	<div style="border: 1px solid black; padding: 5px;"> <div style="display: flex; justify-content: space-between; align-items: center;"> LEVEL±10° FACE 1 5/5 </div> <p style="text-align: center;">V: 69°58' 30"</p> <div style="display: flex; justify-content: space-between;"> SKIP SET </div> </div>
<p>12 Collimate target B.</p> <p>13 Press [F6](SET) key. Repeat the procedures in step 12 and 13 so that the count of measured times matches to the one in FACE(2). Then the display returns to main menu.</p>	<p>Collimate B (Normal)</p> <p>[F6]</p>	<div style="border: 1px solid black; padding: 10px; text-align: center; margin-bottom: 5px;"> <p>Complete</p> </div>
<p>*1) It is able to get the average value from 1 to 10 measurements. To get the average, repeat the procedures in steps 4, 5 or 9, 10. The measured times is counted in the second line of display.</p> <p>*2) The compensation values of 1) Error of vertical axis (X,Y tilt sensor offset), 2) Collimation error, and 3) Error of vertical angle 0 datum will be set and memorized internally.</p> <p>*3) The operating procedure steps to set compensation value of 4) Error of horizontal axis.</p> <p>*4) Pressing [F1](SKIP) key enables to set next step without changing the last compensated value.</p> <p>*5) Pressing [F1](SKIP) key makes end of setting without changing compensation value.</p>		

8.5 Showing Constant List and Switch ON/OFF Compensation Systematic Error of Instrument

[Example setting: Switch OFF the compensation]

Operating procedure	Operation	Display
1 Press [F5] key from the main menu.	[F5]	<pre> Adjustment ----- F1 V0/Axis (Measurement) F2 V0/Axis (Constant list) F3 Date Time F4 Instrument constant ↓ </pre>
2 Press [F2] key . Correction values are displayed.	[F2]	<pre> Vco: -1°57'12" Hco: -0°00'20" HAX: -0°00'20" EXIT ON OFF </pre>
3 Press [F6](OFF) key.	[F6]	<pre> Vco: -1°57'12" Hco: _____ HAX: _____ EXIT ON OFF </pre>
4 Press [F1](EXIT) key. The display returns to main menu.	[F1]	

8.6 How to adjust the date and time

Operating procedure	Operation	Display
1 Press [F5] key from the main menu.	[F5]	<pre> Adjustment ----- F1 V0/Axis (Measurement) F2 V0/Axis (Constant list) F3 Date Time F4 Instrument constant ↓ </pre>
2 Press [F3] key .	[F3]	<pre> Current date is 11-25-01 Enter new date (mm-dd-yy) Modify YES NO </pre>
3 Press [F5] (YES) key .	[F5]	<pre> Current date is 11-25-01 Enter new date (mm-dd-yy) EXIT BS </pre>
4 Input new date and press [ENT] key. [Example:01-29-95]	[0][1] [2][9] [9][5] [ENT]	<pre> Current time is 14:55:28 Enter new time (hh-mm-ss) Modify YES NO </pre>
5 Press [F5] (YES) key.	[F5]	<pre> Current time is 14:55:28 Enter new time (hh-mm-ss) EXIT BS </pre>
6 Input new time and press [ENT] key. [Example:13:20:50] The display returns to main menu.	[1][3] [2][0] [5][0] [ENT]	
<ul style="list-style-type: none"> ● Enables you to change the order of date, see Chapter 7 "PARAMETERS SETTING MODE" . 		

8.7 How to Set the Instrument Constant Value

To set the Instrument constant which is obtained in section 8.1 -Checking and Adjusting of Instrument Constant, follow as below.

Operating procedure	Operation	Display
1 Press the [F5] key from the main menu.	[F5]	<pre> Adjustment ----- F1 V0/Axis (Measurement) F2 V0/Axis (Constant list) F3 Date Time F4 Instrument constant ↓ </pre>
2 Press [F4] (Instrument constant) key. (GTS-600AF series needs to get to next page by pressing the [F6](↓) key.	[F4]	<pre> Instrument Constant EDM OFFSET (mm) 0.0 Modify YES NO </pre>
3 Press [F5] (YES) key .	[F5]	<pre> Instrument Constant EDM OFFSET (mm) 0.0 This is not Prism Offset EXIT BS </pre>
4 Input value and press [ENT] key.	Input value [ENT]	<pre> Instrument Constant EDM OFFSET (mm) 1.2 The old value will be erased! OK CANCEL </pre>
5 Press [F5](OK) key. The display returns to main menu.	[F5]	<pre> Complete </pre>

8.8 Reference Frequency Checking Mode

The beam modulated by the reference frequency of EDM is emitted continuously.
This mode is used for frequency test mainly.



Operating procedure	Operation	Display
<p>1 Press the [F5] key from the main menu.</p>	<p>[F5]</p>	<pre>Adjustment ----- F1 V0/Axis (Measurement) F2 V0/Axis (Constant list) F3 Date Time F4 Instrument constant ↓</pre>
<p>2 Press the [F6](↓) key to get to next page on the display.</p>	<p>[F6]</p>	<pre>Adjustment ----- F1 FRQ check ↑</pre>
<p>3 Press the [F1] key. The beam will be emitted.</p>	<p>[F1]</p>	<pre>FRQ Check During the signal output•• EXIT</pre>
<p>4 To return to the main menu icons, press the [F1] (EXIT) key.</p>	<p>[F1]</p>	

9 SETTING THE PRISM CONSTANT VALUE

The prism constant value of Topcon is set to zero. When using prism other than Topcon's, it is necessary to set the prism constant correction value of that specific prism.

Once you set the correction value for prism constant, it is retained after power is OFF.

- Setting the prism constant value is in the STAR key (★) mode.
- Setting example : The prism constant value : -14mm

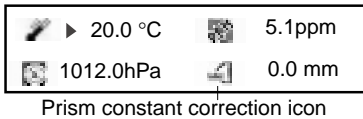
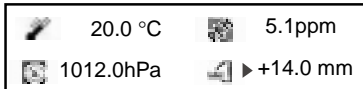
Operating procedure	Operation	Display
1 Press STAR (★) key.	[★]	
2 Press [F6] (↓)key to get the function as in page 2.	[F6]	
3 Press [F3] key. Current setting value is displayed.	[F3]	
4 Move the cursor (>) to the prism constant correction icon by pressing [F5](→,←) key or [F6](↓,↑) key.	Move cursor	
5 Input the Prism constant correction value. *1)	Enter value	
The display returns STAR key menu.	[ENT]	
*1) Input range : -99.9mm to +99.9mm, 0.1mm step		

10 SETTING ATMOSPHERIC CORRECTION

The velocity of light through air is not constant and depends on the atmospheric temperature and pressure. The atmospheric correction system of this instrument corrects automatically when the correction value is set. 15°C/59°F, and 1013.25hPa / 760mmHg / 29.9 inHg is as a standard value for 0ppm in this instrument. The values are kept in the memory even after power is OFF.

- Setting the atmospheric correction value is in the STAR key (★) mode.

10.1 Calculation of Atmospheric Correction

The followings are the correction formulas.
Unit; meter

$$Ka = \left[279.67 - \frac{79.535 \times P}{273.15 + t} \right] \times 10^{-6}$$

Ka: Atmospheric correction value
P: Ambient atmospheric pressure (hPa)
t: Ambient Atmospheric temperature (°C)

The distance L (m) after atmospheric correction is obtained as follow.

$$L = l(1+Ka)$$

l: Measured distance when atmospheric correction is not set.

Example : In case Temperature +20°C, Air pressure 847hPa, *l* =1000 m

$$Ka = \left[279.67 - \frac{79.535 \times 847}{273.15 + 20} \right] \times 10^{-6}$$

$$\approx +50 \times 10^{-6} \text{ (50 ppm)}$$

$$L = 1000(1+50 \times 10^{-6}) = 1000.050 \text{ m}$$

10.2 Setting of Atmospheric Correction Value

- How to Set Temperature and Pressure Value Directly
Measure the temperature and air pressure surrounding the instrument beforehand.
- Example : Temperature: +26°C, Pressure:1020 hPa

Operating procedure	Operation	Display
1 Press STAR (★) key.	[★]	
2 Press [F6] (↓)key to get the function as in page 2.	[F6]	
3 Press [F3] key. Current setting value is displayed.	[F3]	
4 Input Temp.value and press [ENT]key. [Example] Temp. : +26.0°C The cursor moves to Pressure setting automatically	Enter Temp. [ENT]	

10 SETTING ATMOSPHERIC CORRECTION

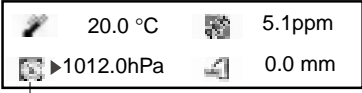
<p>5 Input Pressure value, and press [ENT]. [Example] Pres. :1020.0hPa. The display returns previous mode. *1) *2)</p>	Enter Pres. [ENT]	 <p style="text-align: center;">Pressure setting</p>
<p>*1) Range : Temp. -30.0 °C ~ +60.0 °C (0.1 °C step) Pres. 315.0 ~1066.0hPa (0.1hPa step) , 420.0 ~800.0mmHg (0.1mmHg step) 16.5 ~ 31.5inHg (0.1inHg step)</p> <p>*2) When the atmospheric correction value, which is calculated from the input temperature and pressure values, exceeds the range ± 999.9ppm, the operating procedure returns to step 3 automatically. Input values again.</p>		

•How to Set the Atmospheric Correction Value Directly

Measure the temperature and air pressure to find atmospheric correction value(PPM) from the chart or correction formula.

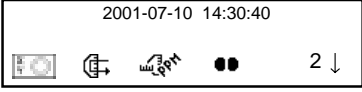
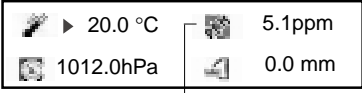
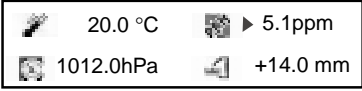
Operating procedure	Operation	Display
1 Press STAR (★) key.	[★]	
2 Press [F6] (→)key to get the function as in page 2.	[F6]	
3 Press [F3] key. Current setting value is displayed.	[F3]	 <p style="text-align: center;">PPM setting</p>
4 Move the cursor (>) to PPM setting by pressing [F5](→) key.	Move cursor	
5 Enter atmospheric correction value and press [ENT] key.*1) The display returns previous mode.	Enter PPM [ENT]	
<p>*1) Input range : -999.9mm ~ +999.9mm, 0.1mm step</p>		

10 SETTING ATMOSPHERIC CORRECTION

Atmospheric Correction Chart (For your reference)

The atmospheric correction value is obtained easily with the atmospheric correction chart. Find the measured temperature in horizontal, and pressure in vertical on the chart.

Read the value from the diagonal line, which represents the required atmospheric correction value.

Example:

The measured temperature is +26°C

The measured pressure is 1013 hPa

Therefore, the correction value is +10ppm

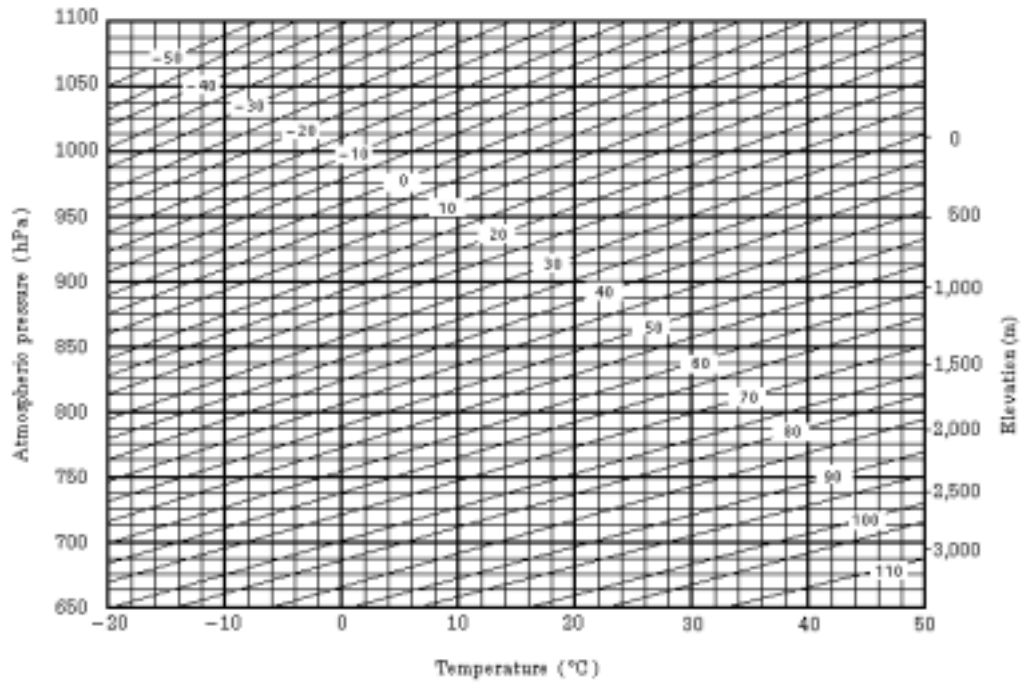

10 SETTING ATMOSPHERIC CORRECTION

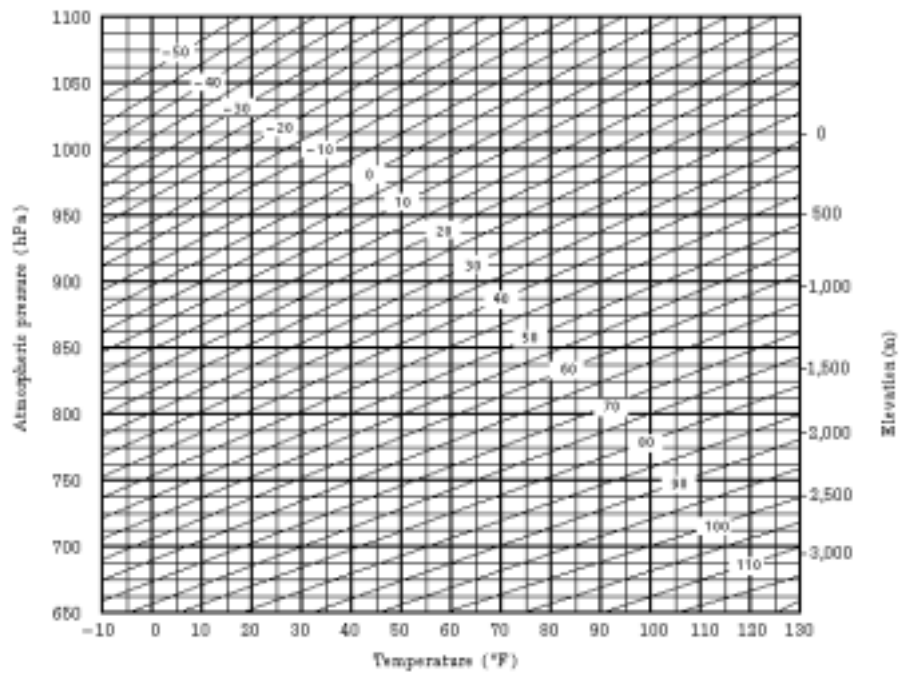
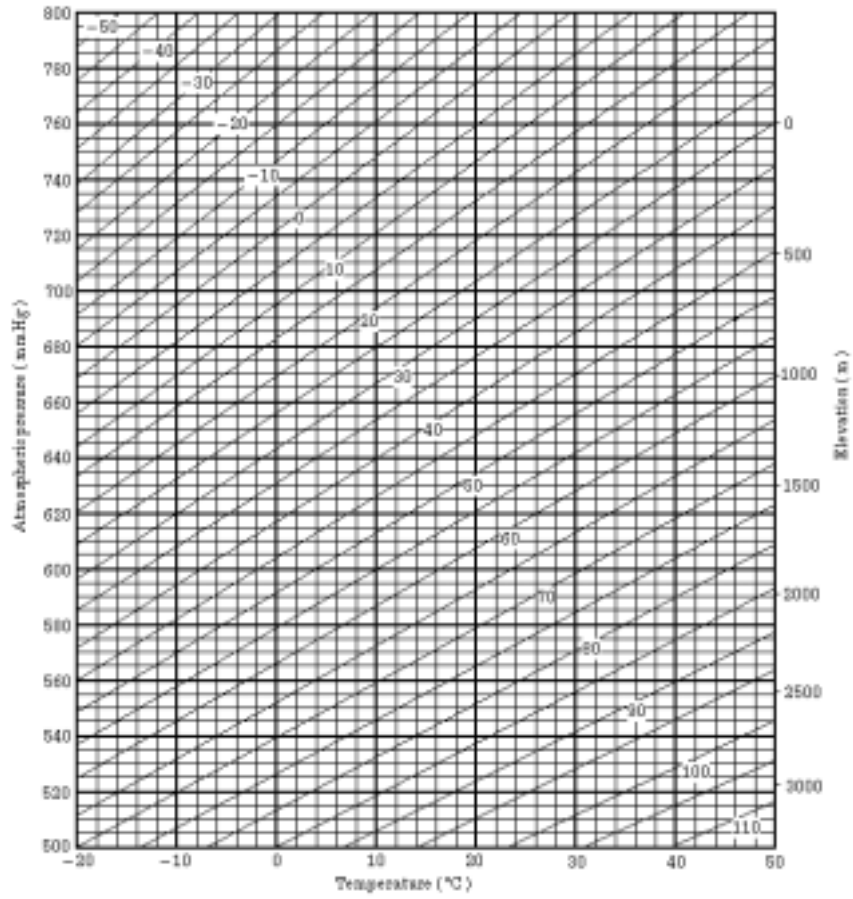

10 SETTING ATMOSPHERIC CORRECTION

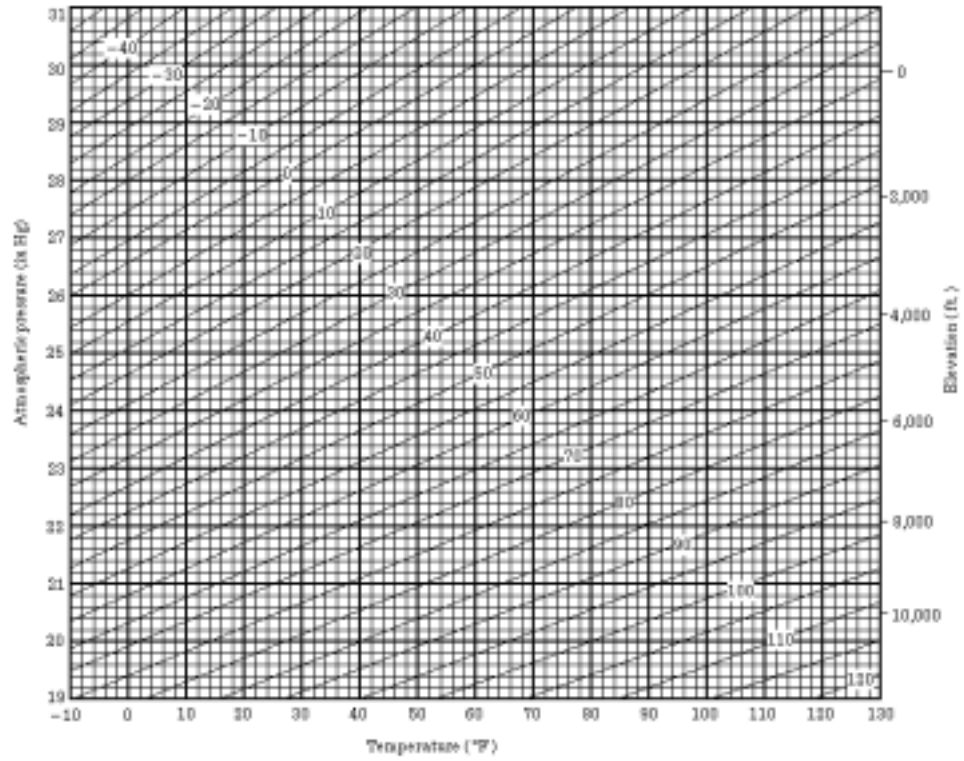

11 CORRECTION FOR REFRACTION AND EARTH CURVATURE

The instrument measures distance, taking into account correction for refraction and earth curvature.

11.1 Distance Calculation Formula

Distance Calculation Formula; with correction for refraction and earth curvature taken into account.

Follow the Formula below for converting horizontal and vertical distances.

Horizontal distance $D = AC(\alpha)$ or $BE(\beta)$	
Vertical distance $Z = BC(\alpha)$ or $EA(\beta)$	
$D = L\{\cos\alpha - (2\theta - \gamma) \sin\alpha\}$	
$Z = L\{\sin\alpha + (\theta - \gamma) \cos\alpha\}$	
$\theta = L \cdot \cos \alpha / 2R$	Earth curvature correcting item
$\gamma = K \cdot L \cos \alpha / 2R$	Atmospheric refraction correcting item
$K = 0.14$ or 0.2	Coefficient of refraction
$R = 6372\text{km}$	Radius of earth
α (or β)	Altitude angle
L	Slope distance

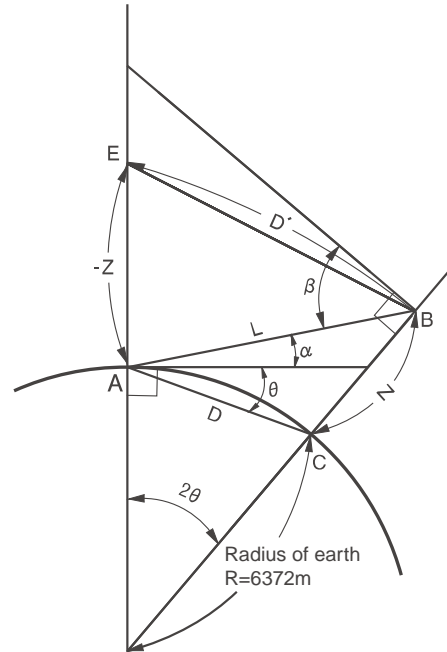

- The conversion formula for horizontal and vertical distances is as follows when correction for refraction and earth curvature is not applied.

$$D = L \cdot \cos\alpha$$

$$Z = L \cdot \sin\alpha$$

Note: The coefficient of the instrument has been set at 0.14 before shipment (K=0.14). if the "K" value is to be changed, refer to 7 "PARAMETERS SETTING MODE".

12 POWER SOURCE AND CHARGING

12.1 On-board Battery BT-50Q

- **To remove**

Remove the battery while pulling both battery fixing levers.

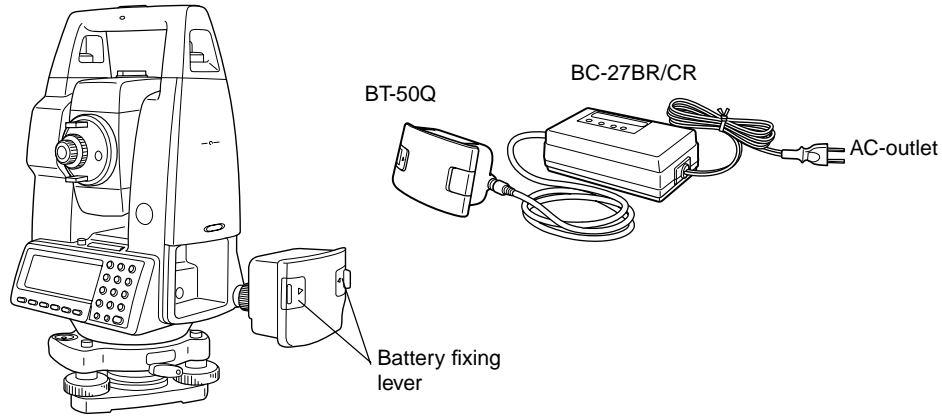

- **To charge**

- 1 Plug the charger into the outlet.
- 2 Connect the charger connector to the battery, then charging will start. Preparatory charging will start. (The red lamp of the charger will blink.) When the preparatory charging is completed, the charging status will be switched to quick charging automatically. (The red lamp of the charger will light.)
- 3 Charging will take approximately 1.8 hours. (The green lamp will illuminate.)
- 4 After charging, remove the battery from the charger. Remove the charger from the outlet.

- **To refresh**

Press the refresh switch after starting charging above steps (1, 2), then discharging will start. Confirm the yellow lamp illuminates.

After discharging is finished, charging will start automatically.

Time discharging battery charged fully is approximately 8 hours.

- **For refreshing**

Rechargeable battery can be used repeatedly by charging. If charging is repeated by the state that capacity of the battery still left, operating time of the battery may shorten. In this case, the voltage of the battery will be recovered by refreshing and operating time can be improved.

- **About Preparatory charging**

Before quick charging, the battery is charged using small amount current to measure its temperature and voltage.

When the temperature and voltage is within a range, the charging status will change to quick charging.

- **The lamp of charger**

Red blinking :	Preparatory charging
Red ON :	Charging
	Red lamp will illuminate during charging.
Green ON :	Charging completed
	Green lamp will illuminate after completely charging.
Yellow ON :	Discharging
	Yellow lamp will illuminate and discharging will start by pressing the refresh (discharge) switch.
Red quick flashing :	Abnormal outbreaks
	Red lamp will flash when the battery life is over or the battery is broken down.
	Replace the battery to new one.

- **To install**

- 1 Place the battery to the instrument.
- 2 Gently push the battery and clicks into position.

12 POWER SOURCE AND CHARGING

- Do not charge or discharge continuously, otherwise the battery and the charger may be deteriorated. If charging or discharging is necessary, use the charger after stopping charge for approximately 30 minutes.
- Do not charge the battery or discharge the battery in right after the battery is charged, it causes deterioration of the battery in rare cases.
- The charger may develop heat while charging, there is no problem of it.

Note:

- 1 Recharging should take place in a room with an ambient temperature range of 10°C to 40°C (50°F to 104°F).
- 2 If charging is done at high temperature, charging time of the battery may take longer.
- 3 Exceeding the specified charging time may shorten the life of the battery and should be avoided if possible.
- 4 The battery source will discharge when stored and should be checked before using with instrument .
- 5 Be sure to charge as stored battery source every 3 or 4 months and store in a place at 30°C and below when it will not used for a long period.
If you allow the battery to be completely discharged, it will have an effect on the overall performance for proper charging in the future.
Keep batteries charged at all times.
- 6 For further information, see APPENDIX 2 "Precaution when Charging or Storing Batteries".

13 DETACH/ATTACH OF TRIBRACH

The instrument is easily detached or attached to the tribrach, with a tribrach locking lever loosened or tightened for this purpose.

• Detachment

- 1) Loosen the tribrach locking lever, by revolving it 180° or 200g in the counterclockwise direction (which will point the triangle mark upwards).
- 2) Grip the carrying handle firmly with one hand while holding the tribrach with the other. Then lift the instrument straight upwards and off.

• Attachment

- 1) Hold the instrument by the carrying handle, with one hand, and carefully lower it on top of the tribrach while, at the same time, coinciding the alignment piece with the tribrach alignment groove on the instrument and tribrach respectively.
- 2) When fully seated, revolve the tribrach locking lever 180° or 200g clockwise (which will point the triangle mark downwards again).

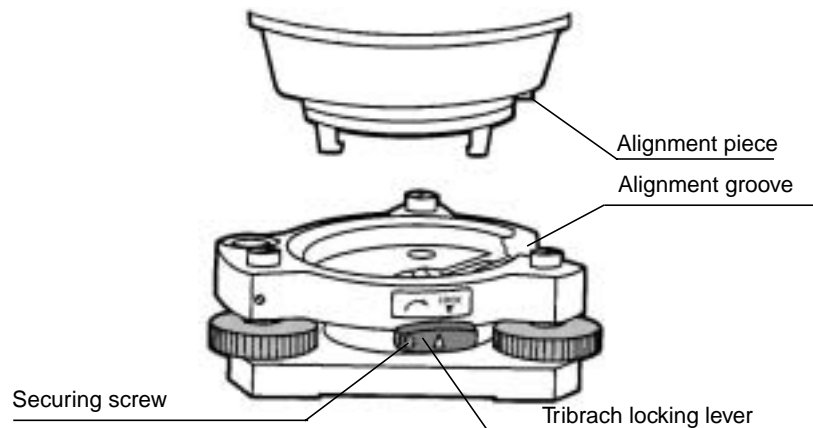

•Locking the Tribrach Locking Lever

The tribrach locking lever can be locked, to prevent it be accidentally removed, especially if the upper instrument section is not being detached very often. Simply tighten the securing screw on the locking lever with the accessory screwdriver, found in the case.

14 SPECIAL ACCESSORIES

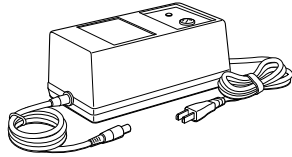

Quick battery charger BC-5 (for BT-3Q)

- Input voltage: 100, 120, 220, 240V
AC: ±10% 50/60 Hz
- Power consumption: 40VA approx.
- Charging time:
approx. 1 hour (+20°C) to charge BT-3Q
- Operation temperature range:
+10°C to +40°C (+50 to +104°F)
- External dimensions:
181(L) × 97(W) × 78(H) mm
- Weight: 1.5kg

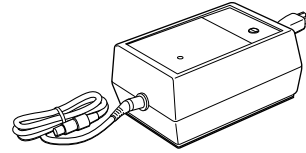

Battery charger BC-6 (for BT-3L)

- Input voltage: 100, 120, 220, 240V
AC: ±10% 50/60 Hz
- Power consumption: 15VA approx.
- Charging time:
approx. 15 hour (+20°C) to charge BT-3L
- Operation temperature range:
+10°C to +40°C (+50 to +104°F)
- External dimensions:
142(L) × 96(W) × 64(H) mm
- Weight: 1.0kg

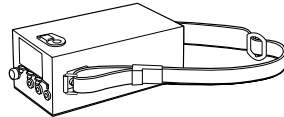

Large capacity battery pack BT-3L

- Output voltage : DC 8.4V
- Capacity: 6AH
- External dimensions:
190(L) × 106(W) × 74(H) mm
- Weight: 2.8kg

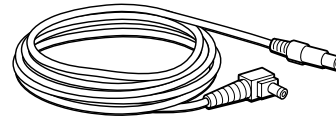

Power cord PC-5

- (For BT-3Q and TOPCON FC series Data collector)
- L-shape plug provided
 - Cord length: 2m approx.

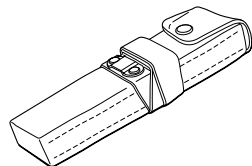

Battery pack BT-3Q

- Output voltage : DC 8.4V
- Capacity: 1.8AH
- External dimensions:
225(L) × 62(W) × 33(H) mm
- Weight: 0.7kg

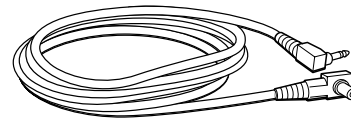

Power cord PC-6 (For BT-3L)

- L-shape plug provided
- Cord length: 2m approx.

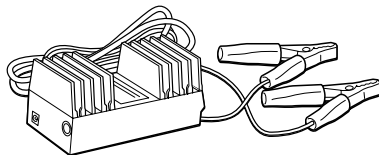

Auto converter AC-5

- Input voltage: 12V DC
- Output voltage : DC 8.4V
- Cable length: 3m approx.
- External dimensions:
100(L) × 53(W) × 47(H) mm
- Weight: 0.3kg

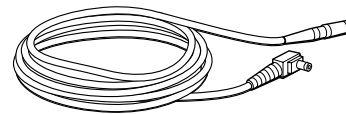

Power cord PC-3 (For AC-5)

- L-shape plug provided
- Cord length: 2m approx.

14 SPECIAL ACCESSORIES

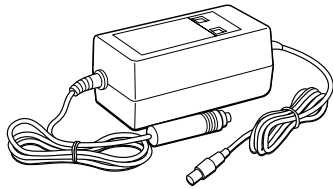

Cigarette battery charger BC-9 (for BT-3Q)

- Input voltage: 13.8V to 16V
- Power consumption: 40VA approx.
- Charging time: approx. 2 hour (+20°C) to charge BT-3Q
- Operation temperature range: +10°C to +40°C (+50 to +104°F)
- External dimensions: 116(L)×60(W)×50(H) mm
- Weight: 0.3kg

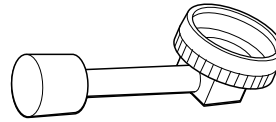

Diagonal eyepiece, Model 10

- Observation in an easy posture will be provided up to the zenith position

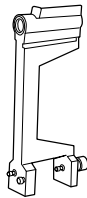

Trough compass, Model 6

Shock proof construction. No clamp is necessary when carrying the instrument.

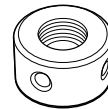

Solar reticle, Model 6

A reticle designed for collimation of the sun. Can be used together with Solar Filter.

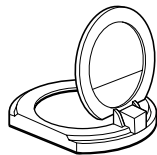

Solar filter, Model 6

A filter designed exclusively for direct collimation of the sun. Solar filter of flap-up type.

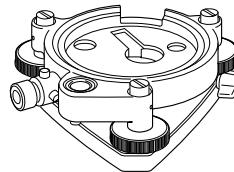

Optical plummet tribrach

This is detachable tribrach having built-in optical plummet telescope. (Compatible with Wild)

14 SPECIAL ACCESSORIES

Prism sets

See the description on Chapter 16 "PRISM SYSTEM"

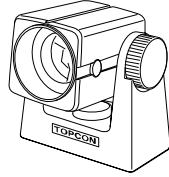

Mini prism

The mini prism (25.4mm) is made from precision ground glass and mounted in high impact plastic housings. The mini has the unique capability of being positioned either at a "0" or "-30" with the same prism



Gadget case, Model 1

A case to store and carry accessories.

- External dimensions:
300(L)×145(W)×220(H) mm
- Weight:1.4kg

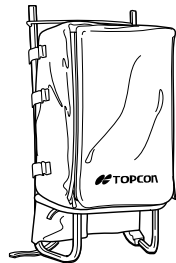

Back pack, Model 2

Convenient for use in mountainous terrain.

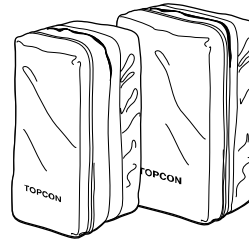

Prism unit case, Model 6

Fixed 9 prisms unit or tilting 3 prisms unit can be stored in this case. Especially, this is a very easy case to carry. Soft material is used.

- External dimensions:
250(L)×120(W)×400(H) mm
- Weight:0.5kg

Prism unit case, Model 5

1 prisms unit or fixed 3 prisms unit can be stored in this case. Especially, this is a very easy case to carry. Soft material is used.

- External dimensions:
200(L)×200(W)×350(H) mm
- Weight:0.5kg

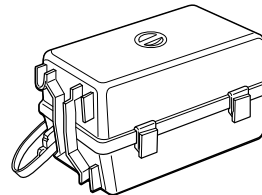

Prism unit case, Model 3

This is the plastic case to store and carry various sets of prisms.

The case covers one of the following prism sets:

- Tilt single prism set
- Tilt single prism set with a target plate
- Fixed triple prism unit
- Fixed triple prism unit with a target plate
- External dimensions:
427(L)×254(W)×242(H) mm
- Weight:3.1kg

14 SPECIAL ACCESSORIES

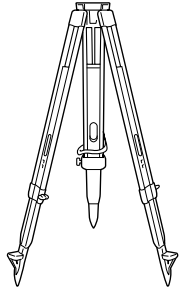

Aluminum extension leg tripod, Type E

- Flat head $5/8" \times 11$ threads with adjustable legs.

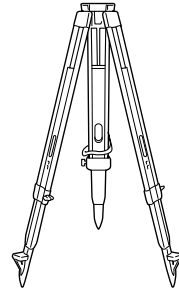

Wide-frame extension leg tripod, Type E (Wood)

- Flat head $5/8" \times 11$ threads with adjustable legs.

15 BATTERY SYSTEM

In case of On-board battery

In case of External battery Pack

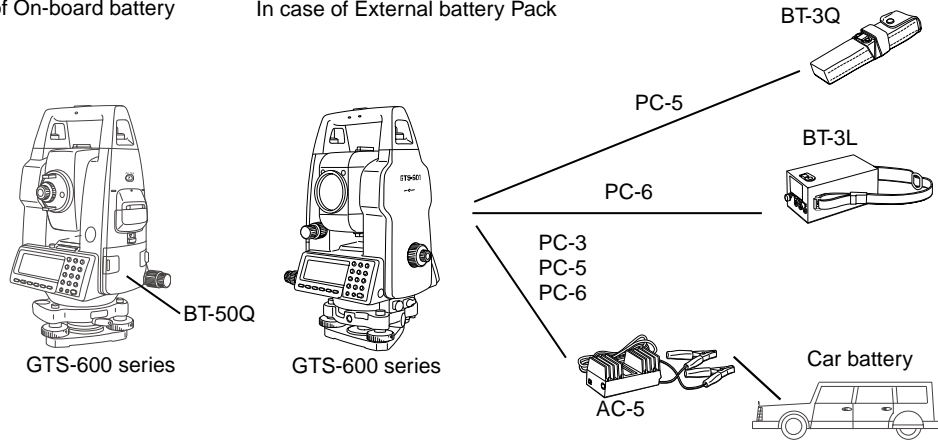

Charging

Charging time

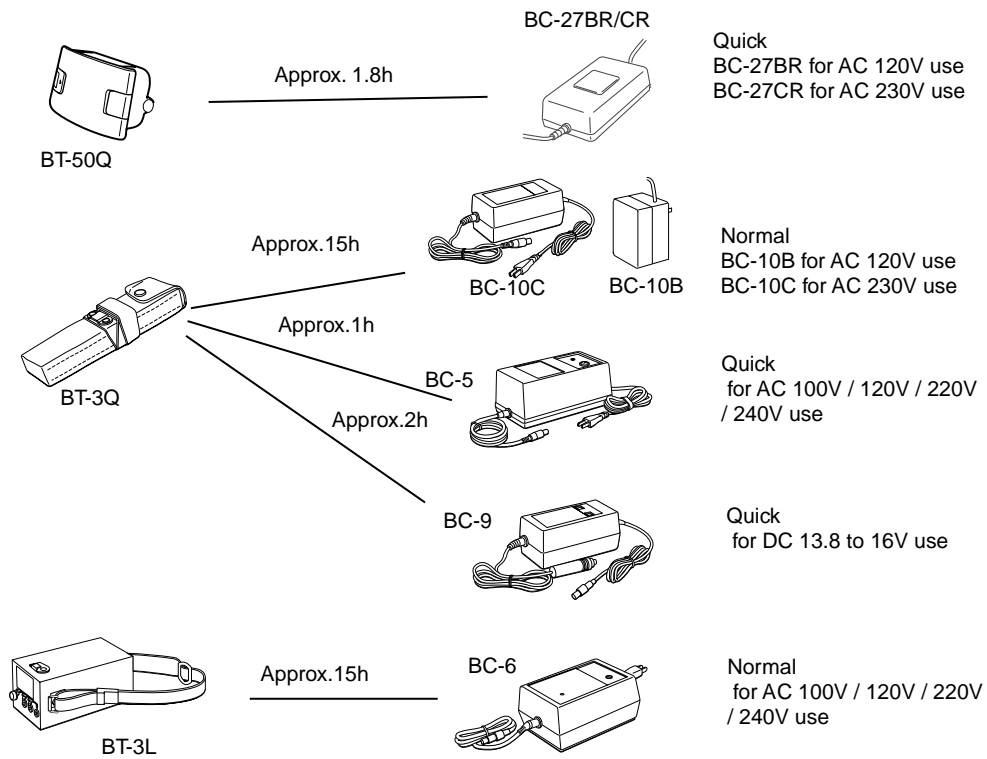

16 PRISM SYSTEM

Arrangement according to your needs is possible.

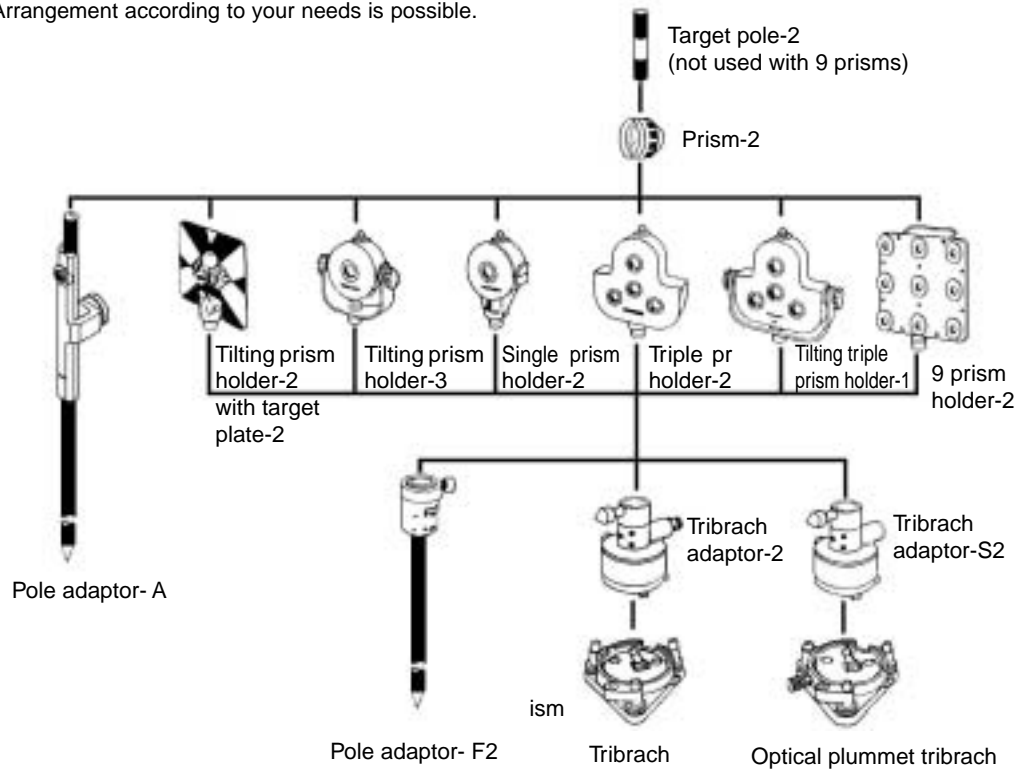

It is possible to change the combination according purpose.

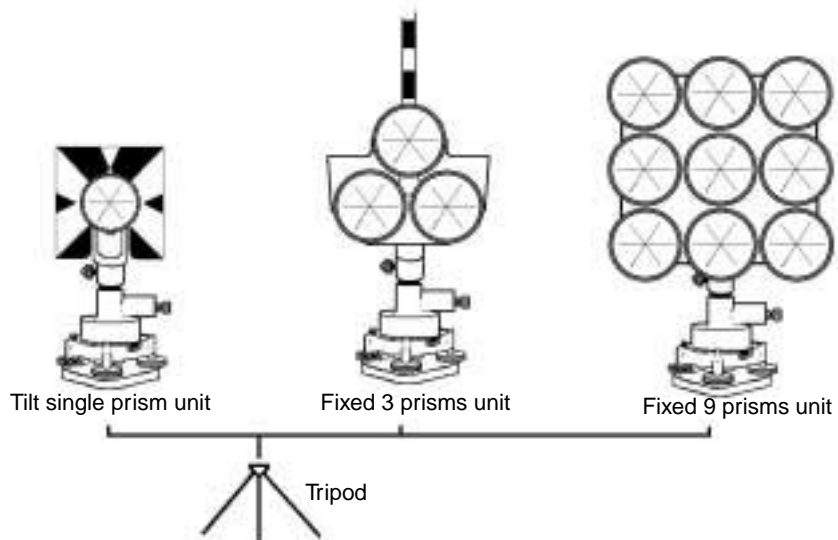

Use the above prisms after setting them at the same height as the instruments. To adjust the height of prism set, change the position of 4 fixing screws.

17 PRECAUTIONS

- 1) For transportation, hold by the handle or yoke of the instrument. Never hold by the lens barrel as it can affect the fixing bracket inside and reduce the accuracy of the instrument.
- 2) Never expose the instrument without a filter to direct sunlight. It may damage the components inside the instrument.
- 3) Never leave the instrument unprotected in high temperature. The temperature inside instrument may easily reach up to 70°C or above and will reduce the service life.
- 4) When a high degree of precision is required for measurement, provide shade against direct sunlight for the instrument and tripod.
- 5) Any sudden change of temperature to the instrument or prism may result in a reduction of measuring distance range, i.e. when taking the instrument out from a heated vehicle.
- 6) When opening the carrying case and taking out the instrument, place the case horizontally, then open the case.
- 7) When returning the instrument to its case, be sure to match the white positioning marks provided with the case and place the instrument with the eyepiece upward.
- 8) For transportation, provide dampening or a cushion appropriately to avoid sudden shock or vibration.
- 9) For cleaning the instrument after use, remove dust using a cleaning brush, then wipe off with a cloth.
- 10) For cleaning the lens surface, use a cleaning brush to remove the dust, then use a clean lintless cotton cloth. Moisten it with alcohol (or mixture with ether) to wipe gently in a rotational motion from the center out.
- 11) Even if any abnormality occurs, never attempt to disassemble or lubricate the instrument yourself. Always consult with TOPCON or your dealer.
- 12) To remove the dust on the case, never use thinner or benzine. Use a clean cloth moistened with neutral detergent.
- 13) Check each part of the tripod after extended use. Parts (screws or clamps) may work themselves free.
- 14) In case the shape of inner material of case is as follows, proceed as follows to put the battery charger back in to the case.
Do not force the battery charger into the case, since it will cause harm to the inner buffer material.

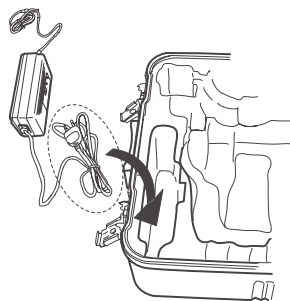

1 Store the plug cable first.

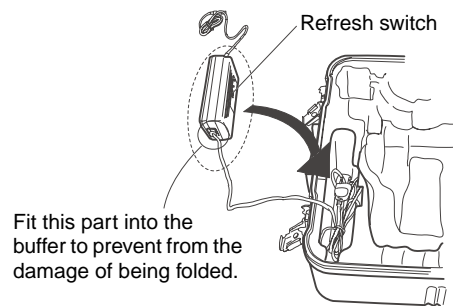

2 Face the panel side of the battery charger as shown in the illustration. Make sure the Refresh switch fits into the inner buffer when placing the charger into the case. As shown in the illustration, handle the cable with care to prevent the cable part from being folded.

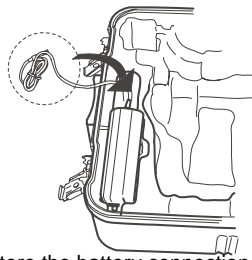

3 Store the battery connection cable to the upper space.

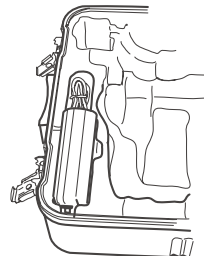

18 ERROR DISPLAYS

Error code	Description	Countermeasures
Backup battery empty	Displayed when built in battery for memory back up is empty.	Contact your dealer or Topcon.
AF Range Over	Displayed when the contrast with the target and its circumference is too low or too high to focus the target automatically. (Only for Auto-focussing model)	Focus the target manually by using the focusing knob.
Focus Error	Displayed when the auto focus is not accomplished for some reasons. (Only for Auto-focussing model)	Retry the auto focus by pressing the auto focus key.
W/C OVER	Displayed when measurement carried out within $\pm 9^\circ$ from zenith or nadir at the Earth curvature and refraction correction mode is ON.	Set correction for refraction and earth curvature mode OFF or measure out of $\pm 9^\circ$ from the zenith or Nadir.
H angle measuring error	Displayed when the instrument rotated too fast or any abnormality occurs in angle measuring system .	The instrument will return to previous mode automatically.
V angle measuring error	Displayed when the telescope rotated too fast or any abnormality occurs in angle measuring system.	The instrument will return to previous mode automatically.
E31	Displayed when the unit of the angle at the recall mode is different from the unit stored in setting mode.	Make the unit in same unit system.
E35	Displayed when REM measurement carried out to the range from zenith or nadir $\pm 6^\circ$.	Operate in the range out of $\pm 6^\circ$ from the zenith or nadir.
E36	Displayed when the N.E coordinates are set same as the instrument coordinate in setting direction angle or lay out mode.	Set except the instrument coordinate value.
E60's	Any abnormality occurs with EDM (distance measuring system).	Repair is required.
E71	Displayed when vertical angle 0 position is set with incorrect procedure.	Confirm the procedure and readjust.
E72	Displayed when Vertical angle -position is adjusted in wrong position.	Confirm the procedure and readjust
E73	The instrument was not leveled when Vertical angle 0-position is adjusted.	Level the instrument then carry the adjustment work.
E81 E82	Mainly at the time data transmission between GTS-600 series and external instrument.	Press [F1](EXIT) key, and confirm the connection cables are correct.

18 ERROR DISPLAYS

Other E80's	Data transmission error between internal P.C.B.'s.	Restart and confirm the operation procedure is correct.
E90's	Abnormality in internal memory system.	Repair is required.
E400's	Abnormality in auto focusing system. (Only for auto-focussing model)	Retry the auto focus by pressing the auto focus key.
E600's	Abnormality in angle measuring system.	If this error code continues to display, repair is required.
E700's	Abnormality in angle measuring system.	If this error code continues to display, repair is required.

- If error still persist after attempting to clear them, contact your local Topcon dealer or Topcon head office.

19 SPECIFICATIONS

Telescope

Length : 150mm
 Objective lens : 45mm (EDM 50mm)
 Magnification : 30x
 Image : Erect
 Field of view : 1°30'
 Resolving power : 2.5"
 Minimum focus : 1.3m
 1.4m (AF type)
 Reticle illumination : Provided

Distance measurement

Measurement range

Prism	Angular acceleration	
	Condition 1	Condition 2
Mini prism	1,000m (3,300ft)	----
1 prism	3,000m (9,900ft)	3,500m (11,500ft)
3 prisms	4,000m (13,200ft)	4,700m (15,400ft)
9 prisms	5,000m (16,400ft)	5,800m (19,000ft)

Condition 1: Sight haze with visibility about 20km (12.5miles) moderate sunlight with light heat shimmer.

Condition 2: No haze with visibility about 40km(25 miles), overcast with no heat shimmer.

Measurement accuracy : ± (2mm + 2ppm • D) m.s.e.
 D : Measuring distance (mm)

Least Count in Measurement

Fine measurement mode : 1mm (0.005ft.) / 0.2mm (0.001ft.)
 Coarse measurement mode : 1mm (0.005ft.)
 Tracking measurement mode : 10mm (0.02ft.)

Measurement Display : 11 digits : max. display 9999999.9999m

Measurement Time

Fine measurement mode : 1mm : 1.2sec. (Initial 4 sec.)
 0.2mm : 2.8sec. (Initial 5 sec.)

Tracking measurement mode : 0.4sec. (Initial 3 sec.)
 Coarse measurement mode : 0.7sec. (Initial 3 sec.)
 (The initial time will be different by a condition)

Atmospheric Correction Range : -999.9 ppm to +999.9 ppm , in 0.1 ppm increments

Prism Constant Correction Range : -99.9 mm to +99.9 mm , in 0.1 mm increments

Coefficient Factor :

Meter / Feet
 International feet 1meter = 3.2808398501 ft.
 US SURVEY feet 1meter = 3.2808333333 ft.

Electronic Angle Measurement

Method : Absolute reading
 Detecting system:
 Horizontal : 2 sides
 Vertical : 2 sides

Minimum reading

GTS-601 series : 1"/0.5" (0.5mgon/0.1mgon, 5mmil/2mmil) reading
 GTS-602 series : 5"/1" (1mgon/0.2mgon, 20mmil/ 5mmil) reading
 GTS-603 series : 5"/1" (1mgon/0.2mgon, 20mmil/ 5mmil) reading
 GTS-605 series : 5"/1" (1mgon/0.2mgon, 20mmil/ 5mmil) reading

Accuracy(Standard deviation based on DIN 18723)

GTS-601 series : 1"(0.3mgon)
 GTS-602 series : 2"(0.6mgon)
 GTS-603 series : 3"(1.0mgon)
 GTS-605 series : 5"(1.5mgon)

Diameter of circle : 71 mm

Tilt Correction

Type : Automatic vertical and Horizontal index
 Method : Liquid type
 Compensating Range : ±4'
 Correction unit : 1"(0.1mgon)

Computer unit

OS : MS-DOS Ver.3.22
 Internal Memory
 System memory : FEEPROM 512KB
 Main memory : RAM 640 KB
 Data memory : RAM 320 KB
 Program memory : FEEPROM 512KB
 Application program memory : FEEPROM 2MB
 Calendar Clock : Provided

Automatic Focusing (Only for Auto-focussing model)

Method : Detecting a peak of contrast
 Auto focusing range : 2m to ∞
 Auto focusing time : 4 to 5.2 sec. (Brightness more than 1000 lx)

Others

Instrument height : 182mm (7.2in) Base unit detachable
 (Height from the tribrach dish to the center of telescope)

Level sensitivity

Circular level : 10'/2mm
 Plate level : 30"/2 mm

Optical Plummet Telescope

Magnification : 3•
 Focusing range : 0.5m to infinity
 Image : Erect
 Field of view : 4°

Laser Plummet (only for Laser plummet type)

Light source : LD (Visible laser)
 Wave length : 633nm
 Out put : 1mW maximum
 Laser class : CLASS 2 (II) laser product

Compact Flash* Card Slot : Based on Compact Flash (Type I)*
 (only for Card model) Maximum 32 MB

*Compact Flash is a trademark of SanDisk corporation.

19 SPECIFICATIONS

Dimension :	343(H)•230(W)•178(L) mm (13.5(H)•9.1(W)•7.0(L) in)
Weight	
Instrument (with battery)	
GTS-600 series :	5.9kg (13.0 lbs)
GTS-600AF series :	6.0kg (13.2 lbs)
Plastic carrying case :	3.7kg (8.2 lbs)
Durability	
Protection against water and dust	
GTS-600C/600CAF series :	IP54 (Based on the standard IEC60529)
GTS-600/600AFseries :	IP65 (Based on the standard IEC60529)
Ambient Temperature Range :	-20°C to +50°C (-4°F to +122°F)

Rechargeable Battery BT-50Q (This battery does not contain mercury.)

Out put voltage :	7.2 V
Capacity :	2.7 AH (Ni-MH)
Maximum operating time (when fully recharged) at +20°C (+68°F)	
GTS-600/600C series	
Including distance measurement :	6.5hours
Angle measurement only :	14hours
GTS-600AF/600CAF series (The automatic focusing is used once in every 30 seconds.)	
Including distance measurement :	5hours
Angle measurement only :	9hours
Weight :	0.3kg (0.7 lbs)

Battery Charger BC-27BR / BC-27CR

Input voltage :	AC 120V(BC-27BR), AC 230V(BC-27CR)
Frequency :	50/60Hz
Recharging time (at +20°C /+68°F)	
Battery BT-50Q :	1.8 hours
Discharging time (at +20°C /+68°F)	
Battery BT-50Q :	8 hours (in case of full charge)
Operating temperature :	+10°C to +40°C (+50°F to 104°F)
Charging signal :	Red lamp illumination
Refreshing signal :	Yellow lamp illumination
Finishing signal :	Green lamp illumination
Weight :	0.5kg (1.1 lbs)

- Battery using time will vary depending on environmental conditions and operations done with GTS-600 series.

APPENDIX

1 Dual Axis Compensation

Inclination of the vertical axis with respect to true vertical will result in incorrectly measured horizontal angles. The extent of the error in horizontal angle measurement due to axis tilt depends on three factors :

- the amount of the tilt of axis
- the elevation of the target
- the horizontal angle between the direction of tilt of the vertical axis and the target.

These factors are related by the following formula :

$$Hz_{err} = v \cdot \sin \alpha \cdot \tan h$$

where v = tilt of axis in arcseconds

α = azimuth angle between vert. axis direction and target

h = elevation of target

Hz_{err} = error in horizontal angle

Example: When the vertical axis is tilted by 30 arcseconds, the target is 10° above the horizon and rotated 90 in azimuth from the direction of the vertical axis error.

$$Hz_{err} = 30'' \cdot \sin 90^\circ \cdot \tan 10^\circ$$

$$Hz_{err} = 30'' \cdot 1 \cdot 0.176326 = 5.29''$$

From the above example it can be seen that horizontal angle errors will increase with steeper vertical sights (tangent will increase as vertical angle increases) and will be at a maximum when the target is at right angles ($\sin 90^\circ = 1$) to the direction of the vertical axis error. Errors will be at a minimum when the sights are nearly horizontal ($h=0$, $\tan 0=0$) and in the same direction as the vertical axis error ($\alpha=0$, $\sin 0=0$). Please refer to the table below to see the relationship between axis tilt (v) and elevation (h) and the error in horizontal angles which results from these factors.

v	h 0°	1°	5°	10°	30°	45°
0"	0"	0"	0"	0"	0"	0"
5"	0"	0.09"	0.44"	0.88"	2.89"	5"
10"	0"	0.17"	0.87"	1.76"	5.77"	10"
15"	0"	0.26"	1.31"	2.64"	8.66"	15"
30"	0"	0.52"	2.62"	5.29"	17.32"	30"
1'	0"	1.05"	5.25"	10.58"	34.64"	1'

It is clear from the table that dual axis compensation has the most benefit when the elevation of the target is greater than 30° and the axis is tilted more than $10''$. The entries indicated in bold in the table show, in fact, that for many common surveying applications i.e. target elevation $<30^\circ$ and axis error $<10''$, virtually no correction would be required. Dual axis compensation is especially suited then for applications where the sights are very steep.

Even though the compensators can correct horizontal angles for vertical axis errors, ***it is still important to use care in setting up the instrument.***

Centering error, for instance, cannot be corrected by the compensators. If the vertical axis is tilted by $1'$ with the instrument 1.4 meters above the ground, a centering error of approx. 0.4mm will result. The maximum effect of this error at 10m is about $8''$ of horizontal angle error.

In order to maintain the increased accuracy possible through dual axis compensation, it is necessary to keep the compensators in proper adjustment. The compensators must agree with the actual level condition of the instrument. Through various environmental stresses, the agreement between the level condition sensed by the compensators and the true level condition of the instrument may be disturbed. In order to reestablish the correct relationship between the compensator and the true level condition of the instrument, it is necessary to carry out the vertical indexing procedure listed on Section 8.4 "Adjustment of Compensation Systematic Error of Instrument". This adjustment will both reset the vertical index (cause a direct + indirect zenith reading to the same elevation to equal 360°) and zero the level reference for the horizontal compensator. While correct vertical angles can be obtained by averaging direct and indirect reading even when the index is improperly adjusted, the same is not true for horizontal angles. Since the vertical axis error is fixed for a given setup, its effect cannot be removed by averaging two readings.

For this reason, it is extremely important to maintain the vertical indexing adjustment to insure proper correction of the horizontal angles.

2 Precaution when Charging or Storing Batteries

The capacity of battery will be affected and its service life shortened in any of the following cases while it is recharged, discharged or stored.

1) Recharging

Fig. 1 shows how ambient temperature at recharging is related to charging efficiency or as affecting discharge capacity. As seen from the figure, charging at normal temperature is best, and the efficiency decreases as the temperature rises. It is best, therefore, to always recharge the battery at normal temperature to obtain full use of battery capacity and enjoy maximum operation per charge. And the service life of your battery will be shortened if it is frequently overcharged or recharged at high temperature.

Note: 0.1C charge means that the battery is recharged with 0.1 -time current as against its capacity.

2) Discharge

Fig. 2 shows discharge temperature characteristics. Discharge characteristics at high temperature are the same as those at normal temperatures. The battery is likely to have reduced discharge capacity as well as lower discharged voltage when discharged at low temperature. And the service life of your battery will be shortened if it is greatly overcharged.

Note: 1C discharge means one with 1 -time current over battery capacity.

3) Storage

See Fig. 3 for how storing period at different temperature levels is related to the remaining capacity. The battery will lose its capacity as storage temperature rises and the storage period increases. This does not mean, however, that the battery performance is damaged when the battery is stored. The battery, reduced in capacity, will be restored once it is recharged. Always recharge your battery before use. And recharge and discharge the battery 3 or 4 times to restore its capacity if it has been stored for a long period or at high temperature. Storing at high temperature can adversely affect the service life of your battery.

Your battery has been fully charged before leaving the factory, but its capacity may be affected considerably when it takes several months to reach you, if it is stored at high temperature area or passes through a high-temperature region. Then, the battery must be recharged and discharged 3~4 times to fully restore its capacity.

And the battery should always be stored at normal temperature or lower if it will not be used for any long period. This helps your battery have a longer service life.

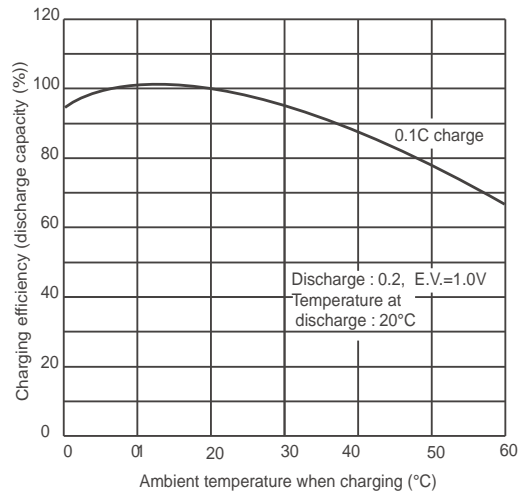

Fig.1 Recharging

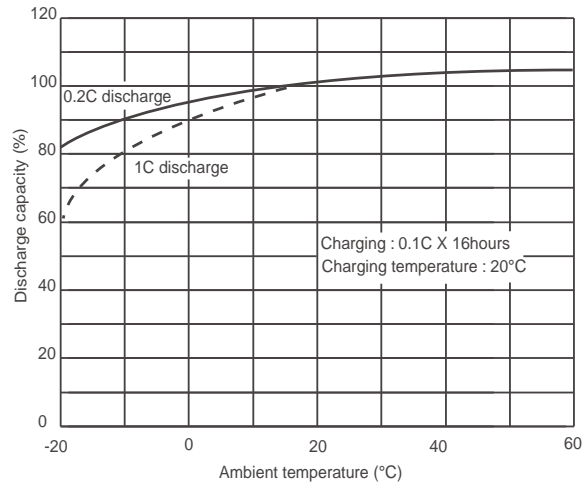

Fig. 2 Discharge

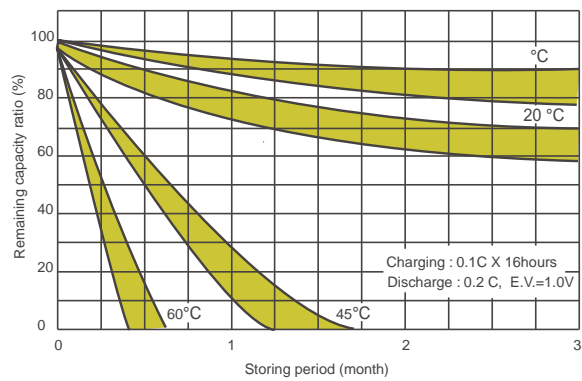

Fig. 3 Storage

END USER LICENSE AGREEMENT

IMPORTANT-- READ CAREFULLY BEFORE USING THE EMBEDDED SYSTEM WHICH CONTAINS MICROSOFT SOFTWARE. By using the embedded system containing software, you indicate your acceptance of the following Software License Agreement.

**SOFTWARE LICENSE AGREEMENT
(Embedded Products)**

This software license agreement, including the Warranty and Special Provisions set forth in the appendix or separate booklet included in this package, is a legal agreement between you (either an individual or an entity, hereinafter "End User") and the manufacturer ("Embedded System Manufacturer") of the embedded system containing software product. By using the embedded system on which software program(s) have been preinstalled ("SOFTWARE"), you are agreeing to be bound by the terms of this agreement.

1. GRANT OF LICENSE. This License Agreement permits you to use the Microsoft SOFTWARE as preinstalled on the embedded system.

2. INTELLECTUAL PROPERTY. GTS-600 SERIES contains intellectual property, i.e., software programs, that is licensed for the end user customer's use (hereinafter "End User"). This is not a sale of such intellectual property. The End User shall not copy, disassemble, reverse engineer, or decompile the software program.

3. COPYRIGHT. The SOFTWARE is owned by Microsoft Corporation or its suppliers and is protected by United States copyright laws and international treaty provisions and all other applicable national laws. Therefore, you must treat the SOFTWARE like any other copyrighted material.

4. U.S. GOVERNMENT RESTRICTED RIGHTS. The SOFTWARE and documentation are provided with RESTRICTED RIGHTS. Use, duplication, or disclosure by the United States Government is subject to restrictions as set forth in sub-paragraph (c)(1)(ii) of The Rights in Technical Data and Computer Software clause at DFARS 252.227-7013 or sub-paragraphs (c)(1) and (2) of the Commercial Computer Software -- Restricted Rights at 48 CFR 52.227-19, as applicable. Manufacturer is Microsoft Corporation/One Microsoft Way/Redmond, WA 98052-6399.

Please see the Warranty and Special Provisions for information concerning governing law.

Product support for the SOFTWARE is not provided by Microsoft Corporation or its subsidiaries. For product support, please refer to Embedded System Manufacturer's support number provided in the documentation for the embedded system. Should you have any questions concerning this Agreement, or if you desire to contact Embedded System Manufacturer for any other reason, please refer to the address provided in the documentation for your embedded system.

FOR THE LIMITED WARRANTY AND SPECIAL PROVISIONS PERTAINING TO YOUR COUNTRY, PLEASE REFER TO EMBEDDED SYSTEM DOCUMENTATION OR THE WARRANTY AND SPECIAL PROVISIONS BOOKLET INCLUDED IN THIS PACKAGE.

**APPENDIX
WARRANTY AND SPECIAL PROVISIONS
LIMITED WARRANTY**

LIMITED WARRANTY. Embedded System Manufacturer warrants that (a) the SOFTWARE will perform substantially in accordance with the accompanying written materials for a period of ninety (90) days from the date of receipt. Any implied warranties on the SOFTWARE are limited to ninety (90) days. Some states/jurisdictions do not allow limitations on duration of an implied warranty, so the above limitation may not apply to you.

CUSTOMER REMEDIES. Embedded System Manufacturer's and its suppliers' entire liability and your exclusive remedy shall be, at Embedded System Manufacturer's option, either (a) return of the price paid, or (b) repair or replacement of the SOFTWARE that does not meet the above Limited Warranty and which is returned to Embedded System Manufacturer with a copy of your receipt. This Limited Warranty is void if failure of the SOFTWARE has resulted from accident, abuse, or misapplication. Any replacement SOFTWARE will be warranted for the remainder of the original warranty period or thirty (30) days, whichever is longer.

NO OTHER WARRANTIES. THE MICROSOFT SOFTWARE PROGRAMS ARE PROVIDED TO THE END USER "AS IS" WITHOUT WARRANTY OF ANY KIND, EITHER EXPRESSED OR IMPLIED, INCLUDING, BUT NOT LIMITED TO, WARRANTIES OF MERCHANTABILITY AND FITNESS FOR A PARTICULAR PURPOSE. THE ENTIRE RISK OF THE QUALITY AND PERFORMANCE OF THE SOFTWARE PROGRAM IS WITH YOU.

NO LIABILITY FOR CONSEQUENTIAL DAMAGES. EMBEDDED SYSTEM MANUFACTURER'S AND ITS SUPPLIERS' SHALL NOT BE HELD TO ANY LIABILITY FOR ANY DAMAGES SUFFERED OR INCURRED BY THE END USER (INCLUDING, BUT NOT LIMITED TO, GENERAL, SPECIAL, CONSEQUENTIAL OR INCIDENTAL DAMAGES INCLUDING DAMAGES FOR LOSS OF BUSINESS PROFITS, BUSINESS INTERRUPTION, LOSS OF BUSINESS INFORMATION AND THE LIKE), ARISING FROM OR IN CONNECTION WITH THE DELIVERY, USE OR PERFORMANCE OF THE SOFTWARE PROGRAM.

SPECIAL PROVISIONS

This Software License Agreement and Warranty are governed by the laws of the State of Washington, U.S.A.

ELECTRONIC TOTAL STATION

GTS-600 series

TOPCON POSITIONING SYSTEMS, INC.

5758 West Las Positas Blvd., Pleasanton, CA 94588, U.S.A.
Phone: 925-460-1300 Fax: 925-460-1315 www.topcon.com

TOPCON CALIFORNIA

3380 Industrial Blvd, Suite 105, West Sacramento, CA 95691, U.S.A.
Phone: 916-374-8575 Fax: 916-374-8329

TOPCON MIDWEST

891 Busse Road, Elk Grove Village, IL 60007, U.S.A.
Phone: 847-734-1700 Fax: 847-734-1712

TOPCON EUROPE B.V.

Essebaan 11, 2908 LJ Capelle a/d IJssel, The Netherlands.
Phone: 010-4585077 Fax: 010-4585045 www.topconeuropa.com

TOPCON BELGIUM

Preenakker 8, 1785 Merchtem, Belgium
Phone: 052-37.45.48 Fax: 052-37.45.79

TOPCON DEUTSCHLAND G.m.b.H.

Weidkamp 180, 45356 Essen, GERMANY
Phone: 0201-8619-100 Fax: 0201-8619-111 ps@topcon.de
www.topcon.de

TOPCON S.A.R.L.

89, Rue de Paris, 92585 Clichy, Cedex, France.
Phone: 33-1-41069490 Fax: 33-1-47390251 topcon@topcon.fr

TOPCON ESPAÑA S.A.

HEAD OFFICE
Frederic Mompou 5, ED. Euro 3, 08960, Sant Just Desvern Barcelona, Spain.
Phone: 93-473-4057 Fax: 93-473-3932 www.topconesp.com

MADRID OFFICE

Avenida Burgos, 16E, 1 28036, Madrid, Spain.
Phone: 91-302-4129 Fax: 91-383-3890

TOPCON SCANDINAVIA A. B.

Neongatan 2 S-43151 Mölndal, SWEDEN
Phone: 031-7109200 Fax: 031-7109249

TOPCON (GREAT BRITAIN) LTD.

HEAD OFFICE

Topcon House Kennet Side, Bone Lane, Newbury, Berkshire RG14 5PX U.K.
Phone: 44-1635-551120 Fax: 44-1635-551170
survey.sales@topcon.co.uk laser.sales@topcon.co.uk

TOPCON SINGAPORE PTE. LTD.

Blok 192 Pandan Loop, Pantech Industrial Complex, #07-01, Singapore 128381
Phone: 2780222 Fax: 2733540 www.topcon.com.sg

TOPCON AUSTRALIA PTY. LTD.

408 Victoria Road, Gladesville, NSW 2111, Australia
Phone: 02-9817-4666 Fax: 02-9817-4654 www.topcon.com.au

TOPCON INSTRUMENTS (THAILAND) CO., LTD.

77/162 Sinn Sathorn Tower, 37th Fl.,
Krungthongburi Rd., Klongtonnai, Klongsarn, Bangkok 10600 Thailand.
Phone: 662-440-1152-7 Fax: 662-440-1158

TOPCON INSTRUMENTS (MALAYSIA) SDN. BHD.

Lot 226 Jalan Negara 2, Pusat Bandar Taman Melawati,
Taman Melawati, 53100, Kuala Lumpur, Malaysia.
Phone: 03-41079801 Fax: 03-41079796

TOPCON KOREA CORPORATION

2F Yooseoung Bldg., 1595-3, Seocho-Dong, Seocho-gu, Seoul, 137-876, Korea.
Phone: 82-2-2055-0321 Fax: 82-2-2055-0319 www.topcon.co.kr

TOPCON OPTICAL (H.K.) LIMITED

2/F., Meeco Industrial Bldg., No. 53-55 Au Pui Wan Street, Fo Tan Road,
Shatin, N.T., Hong Kong
Phone: 2690-1328 Fax: 2690-2221 www.topcon.com.hk

TOPCON CORPORATION BEIJING OFFICE

Room No. 962 Poly Plaza Building, 14 Dongzhimen Nandajie,
Dongcheng District, Beijing, 100027, China
Phone: 10-6501-4191-2 Fax: 10-6501-4190

TOPCON CORPORATION BEIRUT OFFICE

P. O. BOX 70-1002 Antelias, BEIRUT-LEBANON.
Phone: 961-4-523525/961-4-523526 Fax: 961-4-521119

TOPCON CORPORATION DUBAI OFFICE

P.O.Box 28595, 102, Al Nailly Bldg., 245 Abu Hail Road, Deira, Dubai, UAE
Phone: 971-4-2696511 Fax: 971-4-2695272

TOPCON CORPORATION

75-1 Hasunuma-cho, Itabashi-ku, Tokyo 174-8580, Japan
Phone: 3-3558-2520 Fax: 3-3960-4214 www.topcon.co.jp

64532 90330 GTS-600/600C Series A 0110(1A)