

PROFILO COMPACT LED 50



User's Manual rel. 1.0 **GB**

D.T.S. Illuminazione s.r.l. – ITALY
<http://www.dts-lighting.it/>



The Lighting Company

Made in Italy

Le informazioni contenute in questo documento sono state attentamente redatte e controllate. Tuttavia non è assunta alcuna responsabilità per eventuali inesattezze. Tutti i diritti sono riservati e questo documento non può essere copiato, fotocopiato, riprodotto per intero o in parte senza previo consenso scritto della D.T.S .

D.T.S. si riserva il diritto di apportare senza preavviso cambiamenti e modifiche estetiche , funzionali o di design a ciascun proprio prodotto. D.T.S non assume alcuna responsabilità sull'uso o sull'applicazione dei prodotti o dei circuiti descritti.

The information contained in this publication has been carefully prepared and checked. However, no responsibility will be taken for any errors. All rights are reserved and this document cannot be copied, photocopied or reproduced, in part or completely, without prior written consent from D.T.S.

D.T.S. reserves the right to make any aesthetic, functional or design modifications to any of its products without prior notice. D.T.S. assumes no responsibility for the use or application of the products or circuits described herein.

Les informations contenues dans le présent manuel ont été rédigées et contrôlées avec le plus grand soin. Nous déclinons toutefois toute responsabilité en cas d'éventuelles inexactitudes. Tous droits réservés. Ce document ne peut être copié, photocopié ou reproduit, dans sa totalité ou partiellement, sans le consentement préalable de D.T.S.

D.T.S. se réserve le droit d'apporter toutes modifications et améliorations esthétiques, fonctionnelles ou de design, sans préavis, à chacun de ses produits. D.T.S. décline toute responsabilité sur l'utilisation ou sur l'application des produits ou des circuits décrits.

Las informaciones contenidas en este documento han sido cuidadosamente redactadas y controladas. Con todo, no se asume ninguna responsabilidad por eventuales inexactitudes. Todos los derechos han sido reservados y este documento no puede ser copiado, fotocopiado o reproducido, total o parcialmente, sin previa autorización escrita de D.T.S.

D.T.S. se reserva el derecho a aportar sin previo aviso cambios y modificaciones de carácter estético, funcional o de diseño a cada producto suyo. D.T.S. no se asume responsabilidad de ningún tipo sobre la utilización o sobre la aplicación de los productos o de los circuitos descritos.

INDEX:

1- SYMBOLS	4
2- GENERAL WARNING	4
3- GENERAL WARRANTY CONDITION	4
4- TECHNICAL FEATURES	5
5- ACCESSORIES	6
6- IMPORTANT SAFETY INFORMATION	7
6.1 Fire prevention	
6.2 Prevention of electric shock	
6.3 Safety	
7- INPUT / OUTPUT CONNECTIONS	7
8- DMX SIGNAL CONNECTION	8
8.1 DMX Addresses	
8.2 Selecting the DMX address	
9- FIRMWARE UPDATING	9
10- DISPLAY FUNCTIONS	10
11- DMX PROTOCOL	14

1- SYMBOLS

Graphic symbols used on this manual:



THIS SYMBOL INDICATES A HOT SURFACE



THIS SYMBOL INDICATES ELECTRIC SHOCK RISK



THIS SYMBOL INDICATES GENERAL RISK



THIS SYMBOL MEANS YOU CAN PLACE THE UNIT ON NORMALLY FLAMMABLE SURFACES

LED \varnothing 30 cm 

THIS SYMBOL INDICATES THE MINIMUM DISTANCE TO BE KEPT BETWEEN THE DEVICE AND THE LIT OBJECT

2- GENERAL WARNING

Read the instruction contained in this user manual carefully, as they give important information regarding safety during installation , use and maintenance.

The device is not for domestic use and must be installed by a qualified electrician or experienced person.

Always disconnect the device from the mains before maintenance.

The device must always be equipped with an efficient ground connection.

3- GENERAL WARRANTY CONDITIONS

The unit is guaranteed for 36 months from the date of purchase against manufacturing material defects.

4- TECHNICAL FEATURES

OVERVIEW

PROFILO COMPACT LED 50 is a professional shaper featuring a single high-power White LED (4,725 Lux / 2 m, 3.000K), and 18°- 36° linear zoom with high-efficiency optical system.

PROFILO COMPACT LED 50 features an internal rotating system with four removable shutters, to give high-precision shaping of light beams.

PROFILO COMPACT LED 50 is a modern alternative to conventional lights, improving light quality, flexibility of use and installation, energy savings and component duration.

In fact the fixture doesn't heat up, and the projection is always flicker free.

Also, the dimming curves are similar to those of halogen lamps.

PROFILO COMPACT LED 50 is contained in a strong housing with folded edges, designed to resist all the rigors of continuous use.

PROFILO COMPACT LED 50 features a reversible yoke for using the projector in any position. Also, the yoke has an exclusive round flange + clutch system which guarantees a perfect grip and safer operation.

PRODUCT CODES:

03.TP015.46	PROFILO COMPACT LED 50 *White 3.000°K *Black
03.TP016.46	PROFILO COMPACT LED 50 *White 4.000°K *Black
03.TP017.46	PROFILO COMPACT LED 50 *White 5.000°K *Black

LED Technology

1 x White LED (3.000 °K, 4000°K or 5000°K)

CRI > 90; LED Max power: 50W

Optical group

18°-36° linear zoom; 2100 Lux / 3 m (18°)

Shutters

4 removable shutters

Control

2 DMX channels

4 digit 7 segments display + 4 soft keys

Connectors

Power supply: POWERCON IN & OUT connectors

DMX: 5 poles In & Out connectors

Power supply

Electronic full-range AC 90-260V , 50/60 Hz

Weight

4,9 Kg

DIMENSIONS

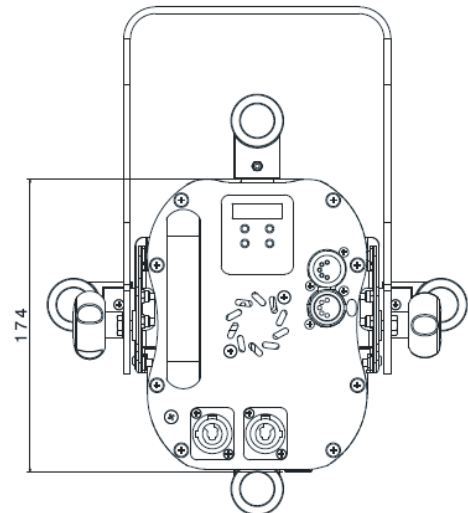
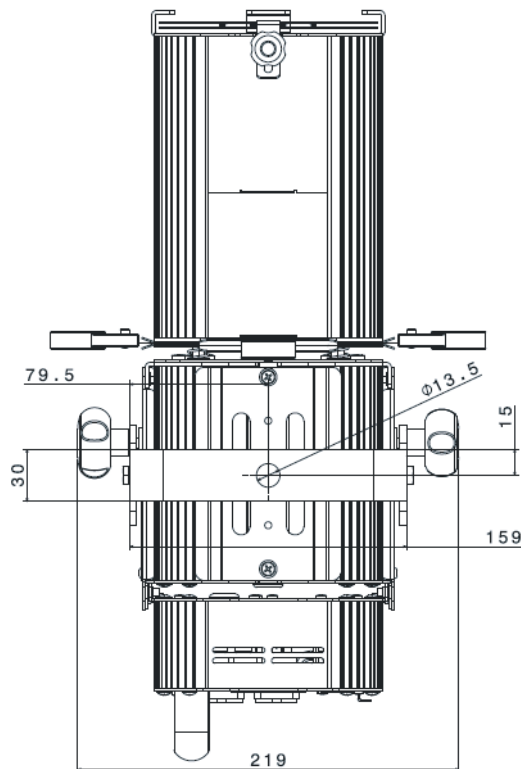
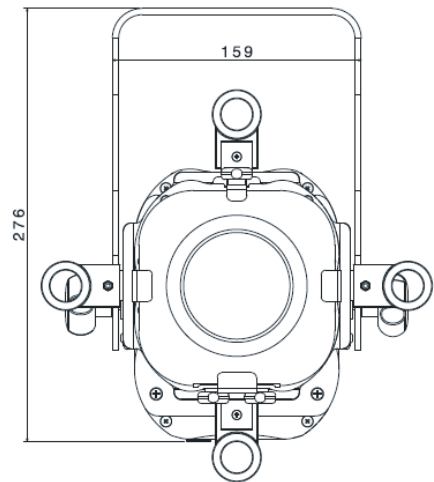
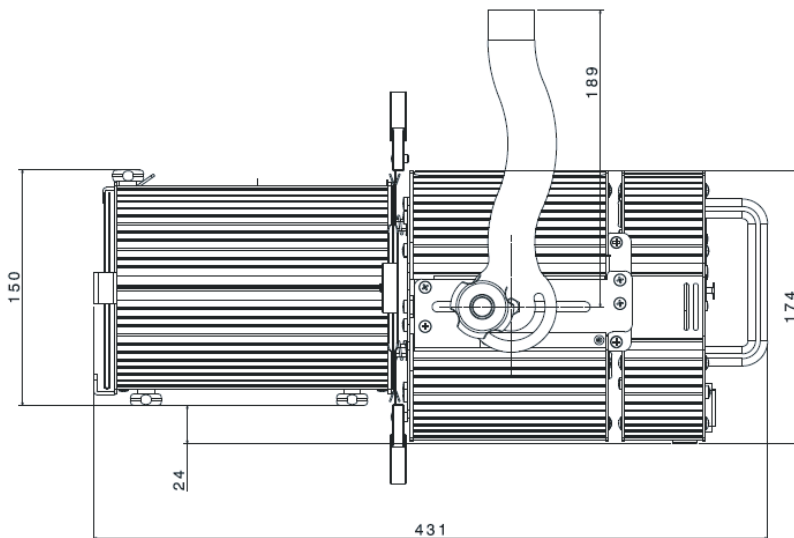

5- ACCESSORIES

As standard

- 1 x User's Manual
- 1 x POWERCON male cable connector (D.T.S. Code 0520P014)
- 1 x XLR 5 pins male cable connector (D.T.S. Code 0508B028)
- 1 x XLR 5 pins female cable connector (D.T.S. Code 0508B027)
- 4 x Shutter blades (Single blade D.T.S. Code 02SK0041)

Optional (on request)

- "C" Clamp G60 (Max. Load. 50 Kg) *Black finish (D.T.S. Code 0521A004)
- Gobo holder (D.T.S. Code 03.TA208)
- Iris/diaphragm (D.T.S. Code 03.TA207)
- Barndoor *Black finish (D.T.S. Code 03.TA206)
- Filterframe *Black finish (D.T.S. Code 02M00422.46)

7- IMPORTANT SAFETY INFORMATION

7.1 Fire prevention:

It is permissible to place the unit on normally flammable surfaces.
Suitable for mounting on normally flammable materials surfaces greater than 200°C with some combustion time lag.

Minimum distance from the closest illuminable surface: 30 cm. LED (130 cm) 

Replace any blown or damaged fuses only with those of identical value (1AT).

7.2 Prevention from electric shock:



High voltage is present inside the unit.

Unplug the unit prior to performing any operation which involves touching the inside of the unit.

This equipment must be grounded, do not connect to non-grounded supplies.

The use of a thermal magnetic circuit breaker is recommended for each PROFILO COMPACT LED 50 unit. Use only AC supplies 90-260V , 50 / 60 Hz.

PROFILO COMPACT LED 50 should never be located in position exposed to rain or in areas of extreme humidity.

A good air ventilation is essential for proper equipment work.

7.3 Safety:



The external surface of the unit may exceed 50°C; never handle the unit until at least 5 minutes have elapsed since the unit was turned off.

Never install the unit in an enclosed area lacking sufficient air flow.

The ambient temperature should not exceed 40°C and should not be lower than -10°C.



8- INPUT / OUTPUT CONNECTIONS

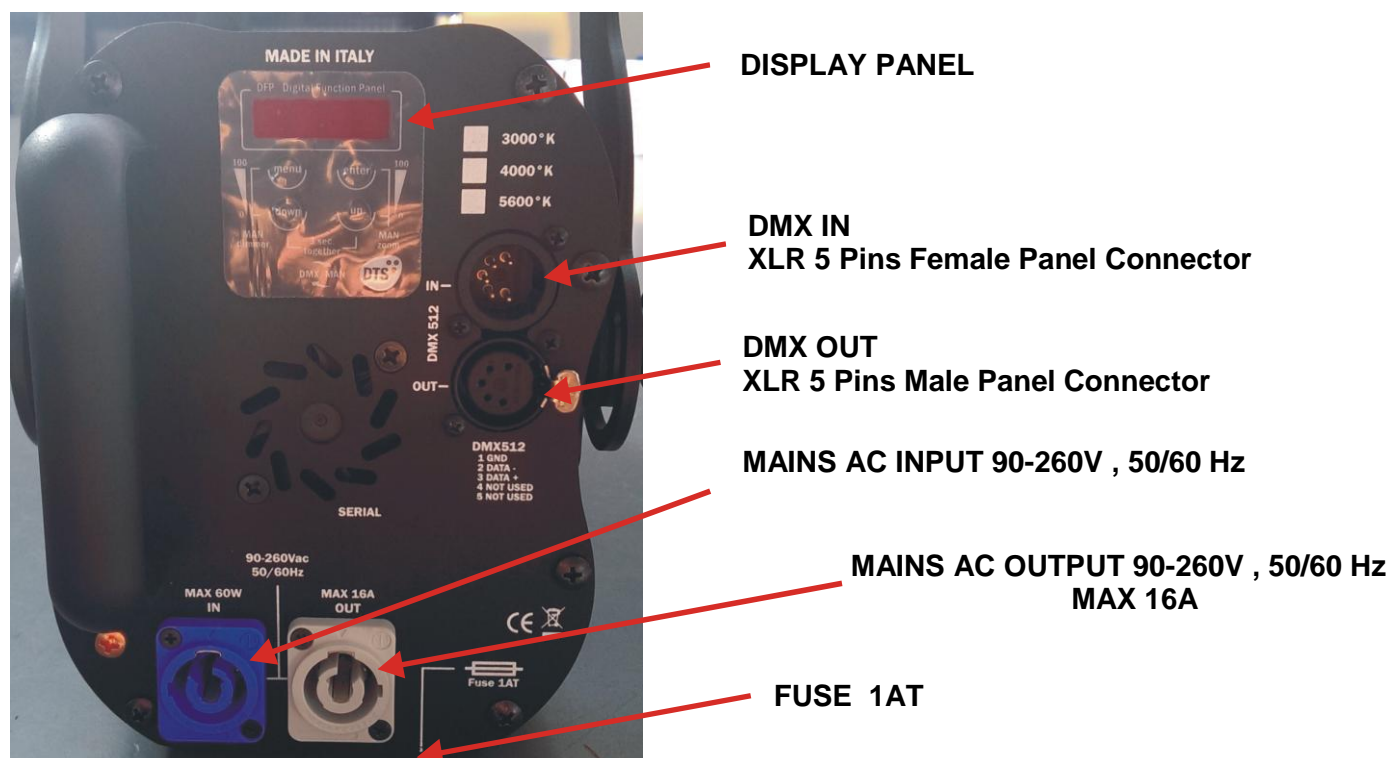

9- DMX SIGNAL CONNECTION:

The unit operates using a digital DMX 512 signal.

Connection between the controller and the unit or between units must be carried out using a two pair screened \varnothing 0.5 mm.

Ensure that the conductors do not touch each other.

Do not connect the cable ground to the DMX connector chassis.

The plug housing must be isolated. Connect the mixer signal to the DMX IN projector plug and connect it to the next projector by connecting the DMX OUT plug on the first unit to the DMX IN plug of the second one.

In this way, all the projectors are cascade connected.

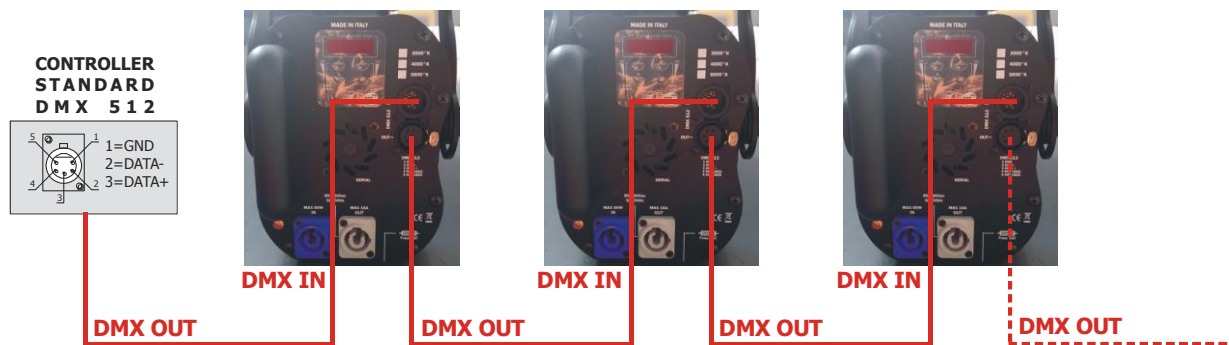

If the display showing the DMX address flashes, then one of the following errors has occurred:

- DMX signal not present
- DMX reception problem

For Installations where long distance DMX cable connections are needed, we suggest to use a DMX terminator.

The DMX terminator is a male XLR 3-5 pins connector with a 120 ohm resistor Between pin 2 and 3.

The DMX terminator must be plugged into the last unit (DMX out panel connector) of the DMX line.

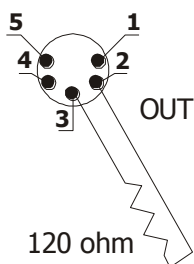

PLACE A 120 OHM RESISTOR BETWEEN PIN 2 AND 3 OF A MALE XLR CONNECTOR AND PLUG IT INTO THE DMX OUT PANEL CONNECTOR OF THE LAST UNIT CONNECTED TO THE DMX LINE

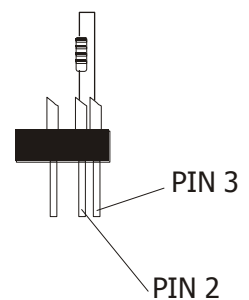

9.1 DMX addresses

PROFILO COMPACT LED 50 can be controlled with 2 DMX channels.
In order to use the unit in 2 DMX channels mode, set the following addresses on the mixer:

Projector 1	A001	
Projector 2	A003	If you want to select the next projector, just add "2"
Projector 3	A005	
.....	A....	
projector 6	A011	

9.2 Selecting the DMX address

- 1) Press the UP-DOWN key until you reach the required DMX address. The numbers on the display will start to flash (but the new DMX address hasn't yet been set).
- 2) Press ENTER to confirm your selection. The numbers on the display will stop flashing and the projector is now controlled by the new DMX address.

TIPS: if you keep pushed the UP or DOWN keys, the channels are calculated more quickly and you get a faster selection.

- 2) Press ENTER to confirm your selection. The numbers on the display will stop flashing and the projector is now controlled by the new DMX address.

10- FIRMWARE UPDATING

To update the software version of the PROFILO COMPACT LED 50 you need:

- D.T.S. RED BOX interface (D.T.S. Code: 03.LA.008)
- USB-DMX Driver for the D.T.S. RED BOX interface
- "D.T.S. Firmware upgrade utility" program installed on PC
- Latest firmware release available for PROFILO COMPACT LED 50 unit

Updating the software version.

Please follow the procedure below to perform the update:

1. Install the D.T.S. RED BOX USB-DMX driver on the PC you will use to update the unit software.
2. Connect the D.T.S. RED BOX interface to the PC by using a USB cable.
3. Connect the D.T.S. RED BOX interface to the fixture by using a DMX cable.
4. Send the new software version into the unit by using "D.T.S. Firmware upgrade Utility" program.

10- DISPLAY FUNCTIONS

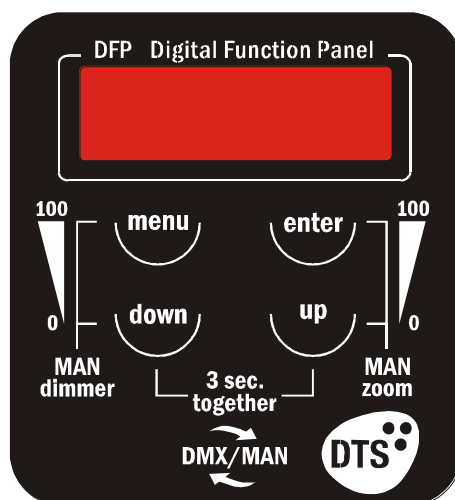

























DISPLAY FUNCTIONS

The PROFILO COMPACT LED 50 display panel shows all the available functions. Using these functions, it is possible to change some of the parameters and add some functions. Changing the D.T.S. setting can vary the functions of the unit so that it does not respond to the DMX 512 used to control it. Carefully follow the instructions below before carrying out any variations or selections.

NOTE: the symbol  shows which key has to be pushed to obtain the desired function.

Software version 1.00

  A001	  DISP	  Pos1	 AA	Floor Position	
REVERSE DISPLAY Reverses display's reading depending on the mounting position (on the ground or suspended).	 Stby	  off	BB	Suspended Position	
DISPLAY STAND BY To turn off the display (after 5 seconds) Or leave it always on.	 on	 on	off	Display Off	
			on	Display Always on	

  mode	  2ch	 2 Channels	Default DMX Mode
DMX MODE To select DMX mode : 2 DMX channels mode (default), 1 DMX channel mode, 3 DMX channels mode or Manual mode. Manual mode can also be activated by pressing at the same time the "UP" + "DOWN" buttons on unit display for 3 seconds ("A001").	 1ch	1 DMX channel mode	
	 3ch	3 DMX channels mode	
	 MAN	 SURE	Manual Mode



LED



Min

Default = 0



LED

Led Min/Max, Smooth, Compression, Sync and Boost level values settings



MAX

Default = 100



LED MINIMUM VALUE

This menu allows to select the minimum levels for white



SMTH



4

Range = Off-20

Default = 4



Quadratic = Linear light output



LED MAXIMUM VALUE

This menu allows to select the maximum levels for white



COMP



QUAD

Linear = Linear Current output



These settings have priority on Master Dimmer channel



Sync



610

Range = 610 Hz – 10 KHz
Default = 610 Hz



SMOOTH VALUE

This menu allows to select the value of the delay (in milliseconds) for Dimmer channel reaction to DMX or Program variation.

Off = 25 ms. Instant response to DMX variation.

20 = 250 ms. Smooth response to DMX variation.



bst



on

Boost mode activated



Boost mode deactivated



With BOOST active, the LED'S current is set to Max value.

(30% more gain compared to BOOST Off)

Default = Disabled

off

COMPRESSION

This menu allows to select between Linear current output or Quadratic current output for LEDs

Default = Quadratic

SYNC

This menu allows to adjust the PWM frequency value (Hz) in order to reduce flickering in the process of your camera recordings

BOOST DRIVING

This menu allow to increase the LED's current from Min to Max



dimmer



255



DIMMER

Dimmer intensity level (range 0-255)

Active only if MODE = 1 DMX channel mode



ir



off



Note:

External infrared remote sensor needed (D.T.S. Code: 03.LA.016)

INFRARED MODE

Infrared remote control.

By activating Ir Mode, it will be possible to navigate through the unit functions by using the D.T.S.

infrared remote control

(D.T.S. Code: 0514L008)

on



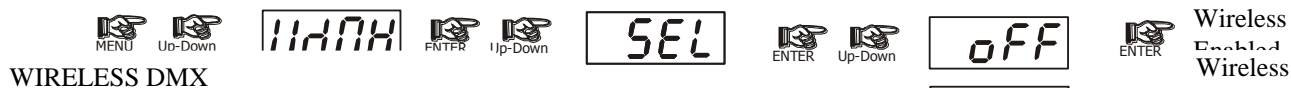

WIRELESS DMX

Wireless DMX enabled / disabled.

By activating WDMX MODE, it will be possible to control PROFILO COMPACT LED 50 via D.T.S. ANTENNA Wireless DMX Transmitter (cod. 03.E1271).

Active only on PROFILO COMPACT LED 50 with Wireless on board

UnLH



UNLINK = LOG OUT

NOT IMPLEMENTED ON PROFILO COMPACT LED 50

Logging on PROFILO COMPACT LED 50 (WIRELESS DMX must be enabled on PROFILO COMPACT LED 50 unit)



To log on the PROFILO COMPACT LED 50 in the WIRELESS system simply press and quickly release the function button on the transmitter.

The transmitter will start flashing rapidly red/green scanning for new free receivers / PROFILO COMPACT LED 50 units. When a PROFILO COMPACT LED 50 logs on to the transmitter the LINK green light on transmitter starts to flash rapidly.

After approximately 10 seconds the transmitter will jump back to normal mode and continue transmitting data. The PROFILO COMPACT LED 50 now try to synchronize to the transmitter.

When synchronized to the transmitter, 2 different modes are possible:

1. Antenna transmitter has detected and transmits a DMX signal, in this mode a solid green light is seen on the transmitter and solid display is seen on PROFILO COMPACT LED 50.
2. No DMX signal connected, the Antenna transmitter will flash red/green; display blinking on PROFILO COMPACT LED 50.

To log PROFILO COMPACT LED 50 off from a transmitter simply select UNLINK function

UnLH

under WIRELESS DMX MENU **UnLH** and press ENTER.

When PROFILO COMPACT LED 50 is logged off, the display is blinking, meaning its available for log in on a new transmitter.

Logging out a PROFILO COMPACT LED 50

Select UNLINK function **UnLH** under WIRELESS DMX MENU **UnLH** and press ENTER.

When PROFILO COMPACT LED 50 is logged off the display is blinking, meaning its available for log in on a new transmitter.

Logging out all PROFILO COMPACT LED 50 units linked to a transmitter

Press and hold the function button of the transmitter for about 3 seconds. When the display is blinking on PROFILO COMPACT LED 50, it mean that the units are logged out.

Transmitter, Status LED

Flashing red/green, no dmx connected.

Solid green, dmx signal detected and transmitted.

Fast flashing red/green, log in mode (every free PROFILO COMPACT LED 50 unit, not logged in to any other transmitter, will be logged on)

PROFILO COMPACT LED 50 Status

Display blinking = not logged on to a transmitter (free).

Solid display = logged on to a transmitter and receiving dmx data.



EMER



SEL



off



Default = OFF

EMERGENCY

Emergency operating mode.

By setting Emergency mode, it will be possible to select Dimmer intensity level that will then ran if DMX signal is missing or not available.

Usefull for Emergency EXIT illumination on public areas.

on



dimm



Default = 204 (80%)



DFSE



SURE



DEFAULT SETTING

To restore default settings



TEMP



0250



Internal unit temperature (° Celsius)

TEMPERATURE

Internal unit temperature visualisation



LIFE



LED



LIFE TIME

This menu show the total unit life time and the LED life time

Unit



Soft



U.1.22

SOFTWARE

Software version

11- DMX PROTOCOL**2 CHANNELS MODE (Default)**

1 SHUTTER / STROBE
2 DIMMER

DMX CHANNEL	1	Parameter: SHUTTER / STROBE
-------------	---	------------------------------------

DMX range Value	Mid Point DMX value	Move Range (degrees)	Mode	Option	Function
000-009					Black-out
010-019					Open
020-029					Black-out
030-119					Strobe (from 3.27 s to 30 ms)
120-149					Pulse up (from 42.6 s to 120 ms)
150-179					Pulse down (from 42.6 s to 120 ms)
180-204					Random strobe (Dimmer channel active)
205-229					Full independent Random Strobe (Dimmer channel disabled)
230-255					Open

DMX CHANNEL	2	Parameter: DIMMER
-------------	---	--------------------------

DMX range Value	Mid Point DMX value	Move Range (degrees)	Mode	Option	Function
000-255					Proportional dimmer

1 CHANNEL MODE

1 DIMMER

DMX CHANNEL	1	Parameter: DIMMER
-------------	---	--------------------------

DMX range Value	Mid Point DMX value	Move Range (degrees)	Mode	Option	Function
000-255					Proportional dimmer

3 CHANNELS MODE

- 1 SHUTTER / STROBE**
- 2 DIMMER**
- 3 DIMMER FINE**

DMX CHANNEL	1	Parameter: SHUTTER / STROBE
-------------	---	------------------------------------

DMX range Value	Mid Point DMX value	Move Range (degrees)	Mode	Option	Function
000-009					Black-out
010-019					Open
020-029					Black-out
030-119					Strobe (from 3.27 s to 30 ms)
120-149					Pulse up (from 42.6 s to 120 ms)
150-179					Pulse down (from 42.6 s to 120 ms)
180-204					Random strobe (Dimmer channel active)
205-229					Full independent Random Strobe (Dimmer channel disabled)
230-255					Open

DMX CHANNEL	2	Parameter: DIMMER
-------------	---	--------------------------

DMX range Value	Mid Point DMX value	Move Range (degrees)	Mode	Option	Function
000-255					Proportional dimmer

DMX CHANNEL	3	Parameter: DIMMER FINE
-------------	---	-------------------------------

DMX range Value	Mid Point DMX value	Move Range (degrees)	Mode	Option	Function
000-255					Proportional dimmer

The information contained in this publication has been carefully prepared and checked. However, no responsibility will be taken for any errors. All rights are reserved and this document cannot be copied, photocopied or reproduced, in part or completely, without prior written consent from D.T.S.

D.T.S. reserves the right to make any aesthetic, functional or design modifications to any of its products without prior notice. D.T.S. assumes no responsibility for the use or application of the products or circuits described herein.

MADE IN ITALY



The Lighting Company

ISO 9001:2008

D.T.S. quality system
is certified to the
ISO 9001:2008 standard



D.T.S. products are designed
and manufactured at the D.T.S.
plants in Italy



05171224

D.T.S. Illuminazione s.r.l. – Via Fagnano Selve 10-12-14 47843
Misano Adriatico (RN) Italia
Tel.: +39 0541 611131. Fax + 39 0541 611111
info@dts-lighting.it www.dts-lighting.it