

GPS VEHICLE TRACKER USER MANUAL



Preface

Thank you for purchasing GPS Vehicle Tracker. This manual shows how to operate the device smoothly and correctly. Make sure to read this manual carefully before using this product. Please note that specification and information are subject to changes without prior notice in this manual. Any change will be integrated in the latest release. The manufacturer assumes no responsibility for any errors or omissions in this document.

Content

1	Summary	3
2	Application	3
3	Hardware Description	
3.1	Connectors	3
3.2	Wires Connection	4
3.3	External Relay Connection	4
3.4	Interior	5
4	Specifications	5
5	SIM Card Installation	6
6	Startup	7
7	Usage	7
8	Fortifying Mode	8
8.1	Engine Started Alert	8
8.2	Movement Alert	8
8.3	Power Cutoff Alert	9
8.4	Application in the Car Alarm System	9
8.5	Checking the Working Status	9
9	Tracking Mode	10
9.1	Initialization	10
9.2	Change the Password	10
9.3	Authorization	10
9.4	Auto Track	11
9.5	Geo-fence	12
9.6	Movement Alert	12
9.7	Overspeed Alert	13
9.8	IMEI Checking	13
9.9	SOS	13
9.10	Low Battery Alert	14
9.11	SMS Center	14
9.12	GSM ID	14
9.13	Motion Sensor	14
9.14	SD Card Function	15
9.15	SIMcard A-B Transformation	15
10	Monitoring Mode	16
11	Remote Oil&Electricity Cut-off Function	16
12	GPRS Setting	16
13	Cautions	19
14	Faults & Solutions	20

1 Summary

Working based on existing GSM/GPRS network and GPS satellites, this product can locate and monitor any remote targets by SMS or GPRS, and guard against theft of Vehicle.

2 Applications

- Rental vehicle / Fleet management etc
- Covert tracking

3 Hardware Description

3.1 Connectors

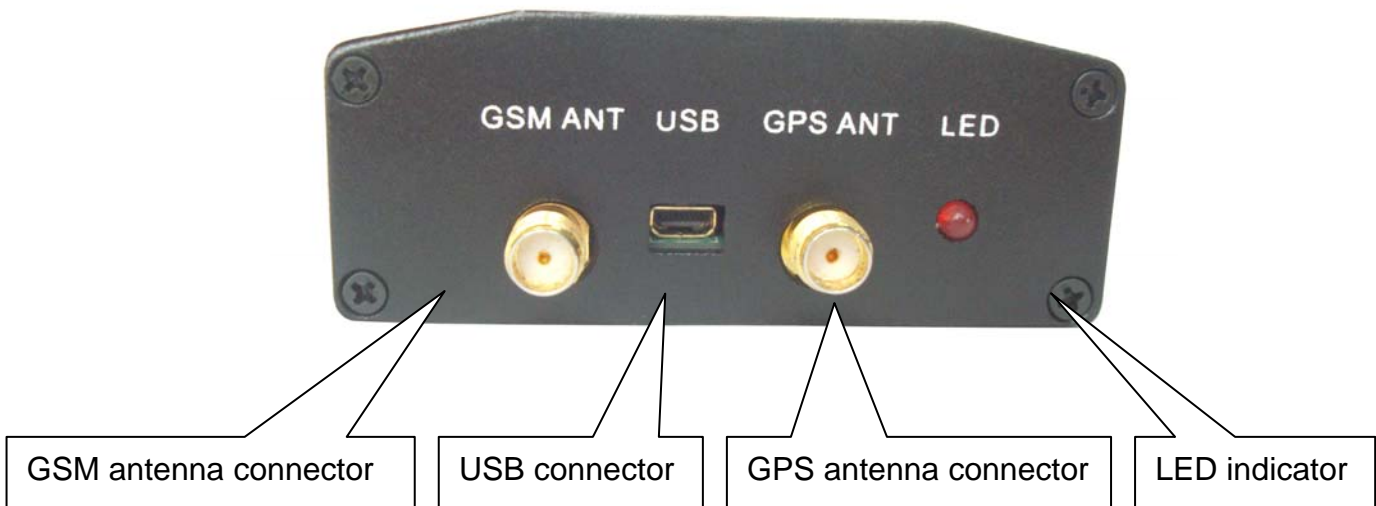
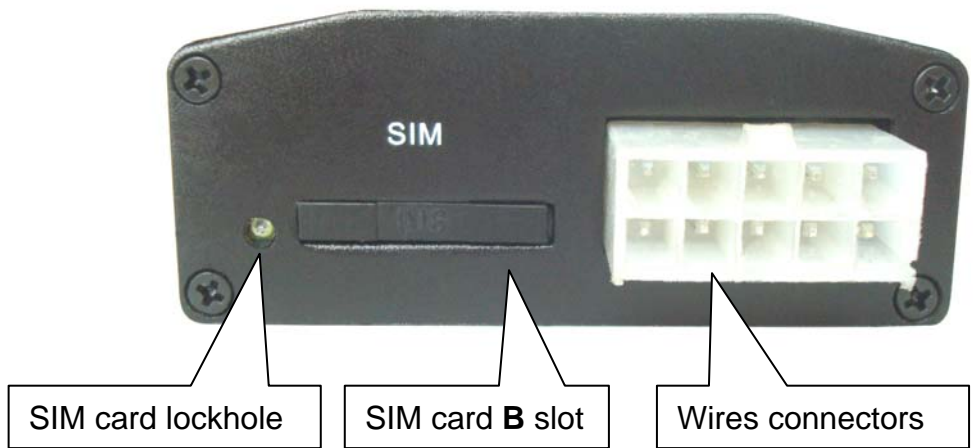

3.2 Wires Connection

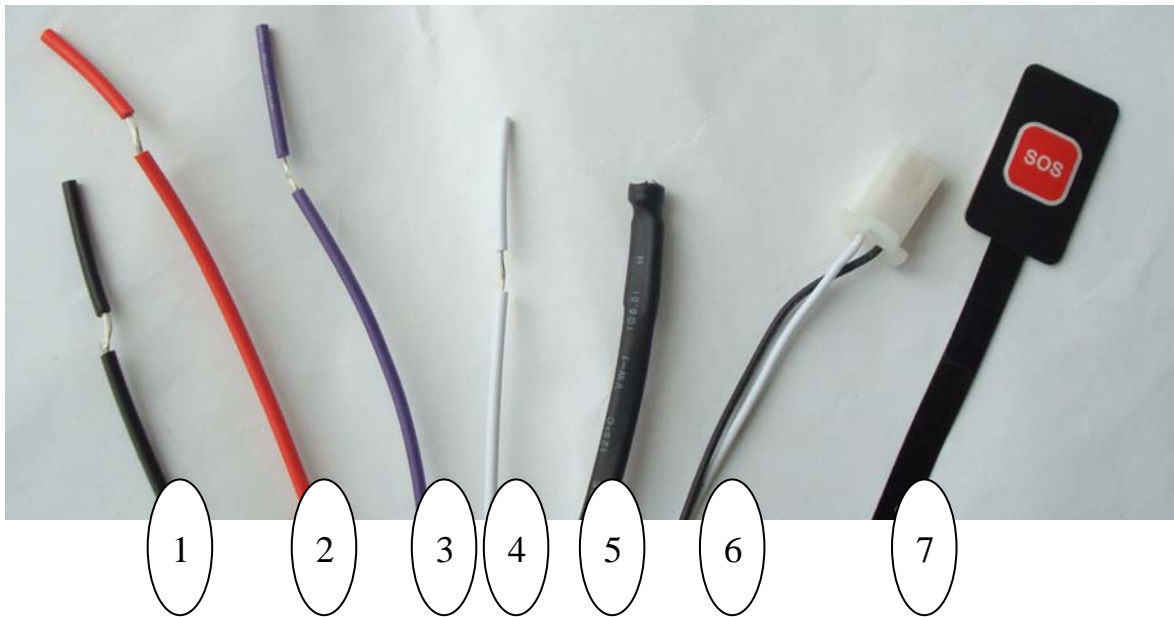

1. Black wire:-12V;
2. Red wire:+12V;
3. Purple wire:ACC;
- 4.White wire:connecting guard against theft implement(reserve-wire,it can be connected or not.)
- 5.Microphone
- 6.External-relay connector
- 7.SOS button

3.3 External relay Connection

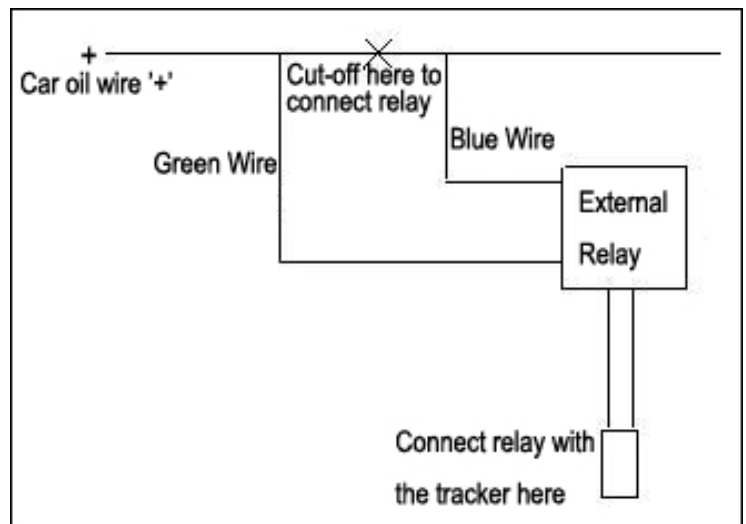
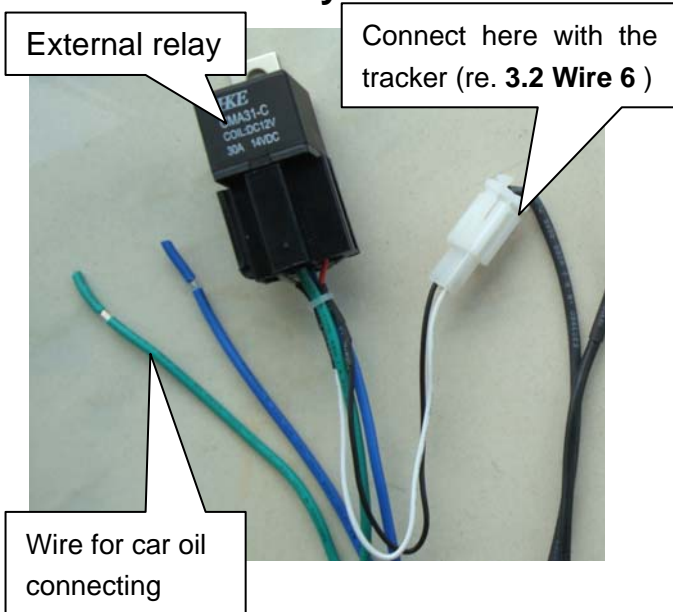

3.4 Interior

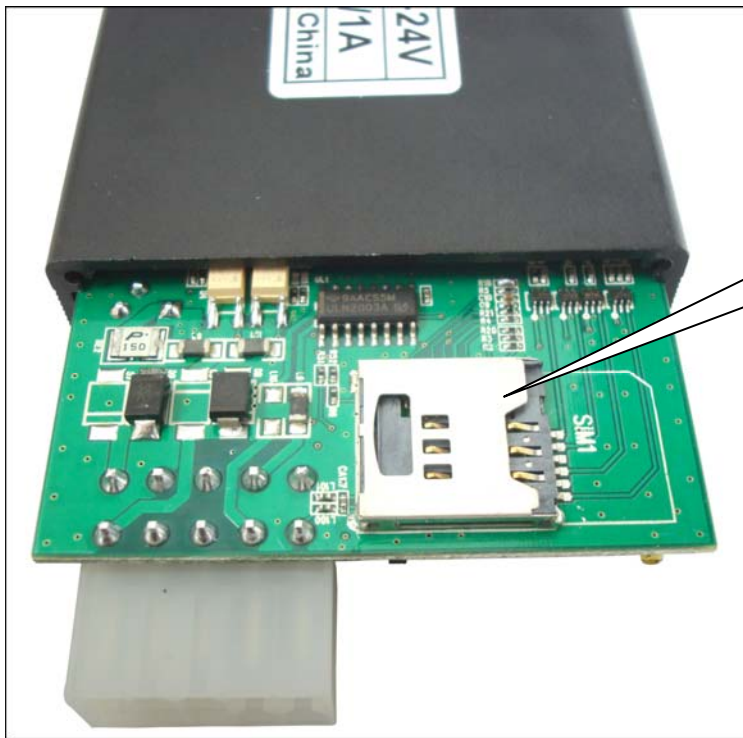

The back side of the mainboard

4 Specification.

Content	Specs.
Dimension.	80mm x 60mm x 25mm
Weight	100g
Network	GSM/GPRS
Band	850/900/1800/1900Mhz or 900/1800/1900Mhz
GPS chip	SIRF3 chip
GPS sensitivity	-159dBm
GPS accuracy	5m
Time To First Fix	Reacquisition 0.1s Cold status 45s Warm status 35s Hot status 1s
Car charger	12—24V input 5V output
Battery	Chargeable changeable 3.7V 1100mAh Li-ion battery
Standby	50hours
Storage Temp.	-40°C to +85°C
Operation Temp.	-20°C to +55°C
Humidity	5%--95% non-condensing

5 SIM card installation

Make sure that there is **no call transfer** and **call display is on**, and **PIN code off**.

Steps:

Install SIM card A:

- 1 Open the tracker rear cover, take out the mainboard, and put SIM card A into the holder.
- 2 Put in a SD card beside the SIM card A (at the back side of the mainboard).
3. Close the tracker back cover by tightened the screws

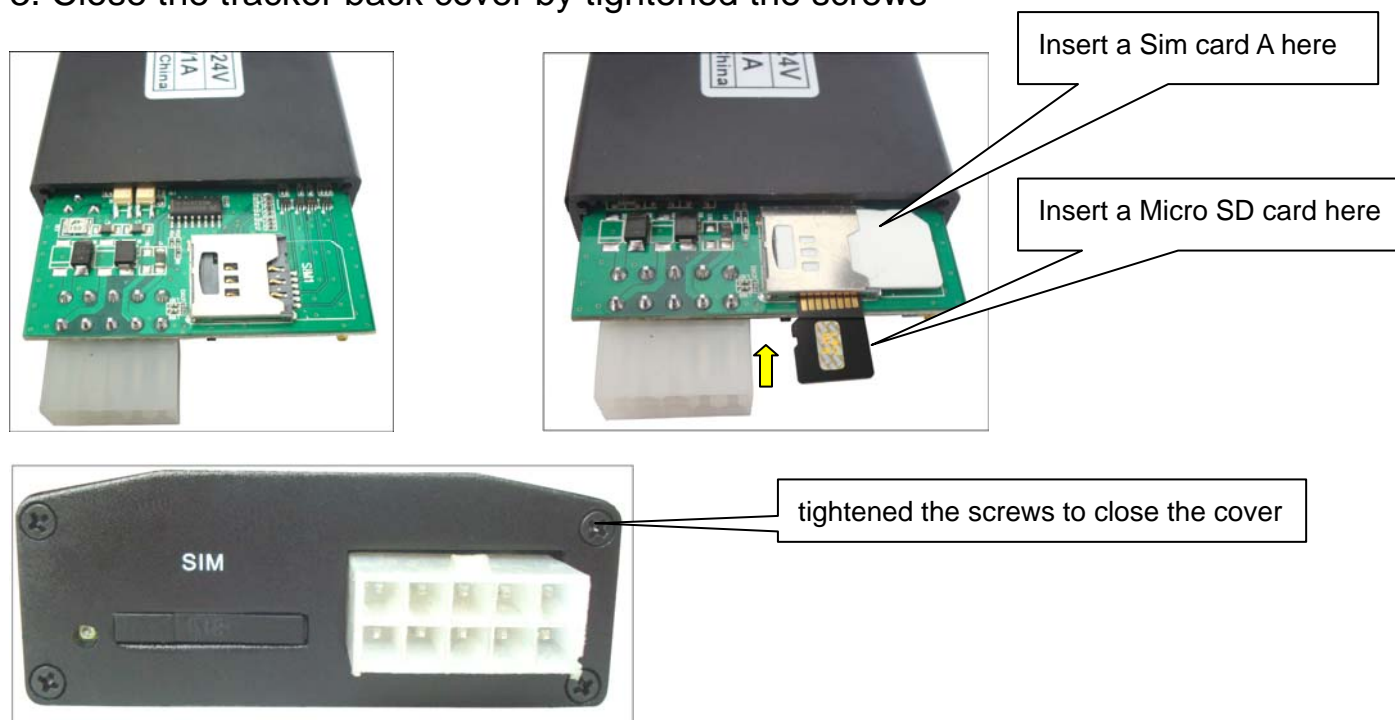

Install SIM card B:

1. Use a pen to open the SIM card B slot
2. Put a SIM card B into the slot.
3. Insert the slot with SIM card into the tracker.

NOTE: If you only use one sim card, then the sim card must be insert into the sim card B slot, but not the sim card A slot on the mainboard.

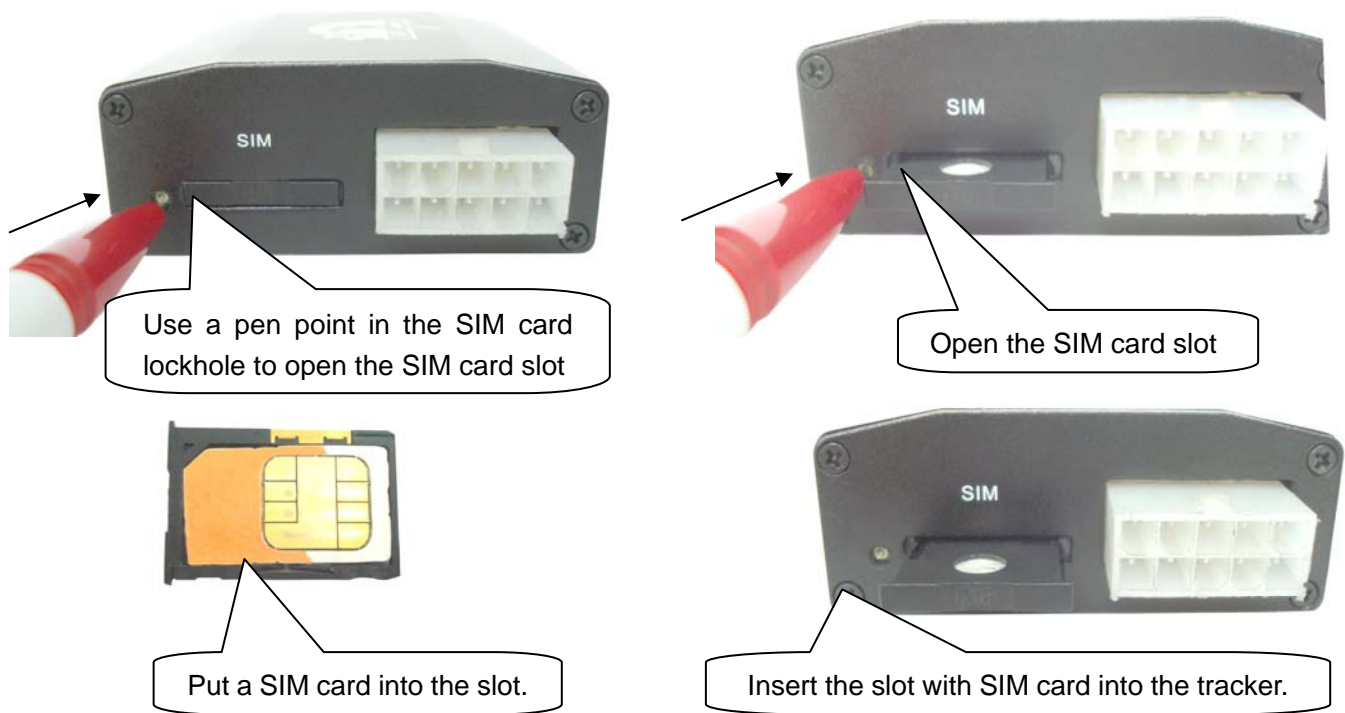

6 Startup

- Put the SIM card,SD card and battery in place. (NOTE:The tracker turns on automatically while the sim card slot B be inserted,and the tracker turns off automatically while the sim card slot B take out.)
- After connecting the wires with the tracker and the car,then you can see the LED indicator flashes red arounds the wires connector(re.3.1 wires connector)
- In 40-60 seconds, the unit will start to work and receive the GSM signals as well as the GPS signals. The indicator keep flashing every 1 second when the unit has received the signals.When this unit receives GPS signals normally, you can use it and do all the following settings.

7 Usage

The tracker has three working modes: Fortifying mode, Tracking mode and Monitoring mode. Modes switch between “fortifying”, “tracking” and “monitoring”.

When power on the tracker, the default mode is “Fortifying” mode, you can send

“tracker+password” to switch to tracking mode, or send “monitor+password” to switch to monitoring mode, or “fortify+password” back to fortifying mode.

8 Fortifying Mode

When turn on the tracker, the default mode is Fortify mode. In fortifying mode, you can call the tracker to activate the “protection” for your loved car or vehicle. The indicator will flash every 4 seconds when the “protection “ is activated.

While the “protection” will be deactivated when you dial up the tracker again, the indicator will flash every 1 second when the deactivation is done.

Remark: If ACC is connected, then you can not activate the “protection” for your car. The tracker will be triggered to send an alert under one of following conditions:

8.1 Engine Started Alert

In fortifying mode, the tracker will start the ACC examine automatically. It will warn up the user when the engine is started.

Alert SMS format: fortify! + lat./long.

It will keep sending such an alert every 3 minutes, you can send “fortify123456” to stop it.

8.2 Movement Alert

This function is using for the owner to get an alert when the tracker moves out of a restricted district (500m radius),

Response SMS format: moved!+lat./long..

It will keep sending such an alert every 3 minutes, you can send “fortify123456” to stop it.

8.3 Power Cutoff Alert

In this mode, the tracker will warn up the user automatically when the main power is cut off unwontedly, such as if someone cut the wire connected the car with the device, it will alert "Battery with coordinates".

Alert SMS format: battery! + lat./long.

It will keep sending such an alert every 3 minutes, you can send "fortify123456" to stop it.

NOTE: These three alerts only occurred when the " protection " is activated in fortifying mode.

8.4 Application in the Car Alarm System

If your car is equipped with a car alarm system, you can connect the white wire (re. **3.2 wire4**) to the positive wire of microphone on the car alarm. The authorized number will receive an alert if the car alarm sounds more than 10 seconds.

Alert SMS format:

lat: 22.567835N long: 114.051397E speed: 000.0 23/12/09 01:55 F:4.22V,1,
Signal:F Trigger imei:356895033307722 06 57.2

8.5 Checking the Working Status (fortify or no fortify)

You can send SMS command "fortified123456" to tracker, it will report " fortifying " or " no fortify " to you.

Reply "no fortify" means out of Fortifying mode, Reply "fortifying" means under Fortifying mode.

When the tracker is in tracking mode or monitoring mode, send a SMS command

"fortify123456" to switch to the "Fortifying mode", under fortifying mode, make a call to activate the protection of your loved ones or car

9 Tracking Mode

9.1 Initialization

Send SMS "begin+password" to the unit, it will reply "begin ok" and initialize all the settings. (default password: 123456)

9.2 Change the Password

Send SMS password+old password+space+new password to change the password. (default password: 123456)

Remark:

9.2.1 Be sure keep the new password in mind, you have to upload the software to restore the original setting in case of losing the new password.

9.2.2 Make sure the new password is in 6 digits, or else the tracker can not recognize the password.

9.3 Authorization

There are only 5 numbers able to be authorized numbers.

9.3.1 Setup:Send SMS admin+password+space+cell phone number to set up the first authorized number.The other authorized numbers should be setup by the first authorized number. If the number is successfully authorized, the unit will reply SMS as "admin ok!".

9.3.2 Cancel:Send SMS noadmin+password+space+authorized number to delete the authorized number.

9.3.3 For roaming purpose, you have to add your country code ahead of the cell phone number, for example, please send admin123456 008613322221111 to tracker to set 13322221111 as an authorized number.

9.3.4 When an authorized number dials up the unit, it will hang up and report a real-time Geo-info as below:

Lat: 22.566901 long: 114.051258 speed: 0.00 14/08/09 06.54 F:3.85V,1,Signal:F help me imei:354776031555474 05 43.5 460 01 2533 720B

Lat: 22.566901 long: 114.051258==Coordinate

0.00 == speed

14/08/09 06.54== Date&Time

F:3.85V == battery power

1 == charging 0 means no charging

Signal:F == Full GPS signal 0 means weak GPS signal

help me == the SOS message, this section is blank for tracking message

354776031555474== IMEI

05=Means you get 5 GPS fix (from 3 to 10)

43.5=Altitude

460 = MCC Mobile Country Code

01 == MNC Mobile Network Code

2533= LAC Location area code

720B= Cell ID

(Remark:GSM ID can be add or delect accroding to customer's requirement)

9.4 Auto-Track

This function is using for the user to receive SMS with Geo-info in a certain time.

9.4.1 Set up: Send SMS t030s005n+password to the unit, it will report the Geo-info at 30s intervals for 5 times.(s: second, m: minute, h: hour).You will receive a reply as “t030s005n OK” if the setting is successful.The setting must be in 3 digits and at maximum 255 in value.

9.4.2 Send SMS t030s***n+password to the unit, it will reply SMS heaps of times. You will receive a reply as “t030s***n ok” if the setting is successful.

9.4.3 Cancel: Send notn+password to delete the “ auto track “.

Remark: the interval must not be less than 30s.

9.5 Geo-fence

Set up a geo-fence for the unit to restrict its movement within a district. The unit will send message to the authorized numbers when it moves out of this district.

Notes: This function will be invalid if the unit moves outside the district. You need to re-set it if you want this function again.

9.5.1 Setup:Send SMS stockade+password+space+latitude,longitude;latitude,longitude to the unit to set the restricted district.

Remark :The first latitude&longitude is coordinate of the top left corner of the Geo-fence, while the second latitude&longitude is the coordinate of the bottom right corner.

9.5.2 Cancel:Send SMS nostockade+password to deactivate this function..

9.5.3 Response SMS format: stockade!+geo-info. It will alarm one time in each setting.

9.6 Movement Alert

This function is using for the owner to get alarm when the tracker moves out of a restricted district.

9.6.1 Setup: Send SMS move+password to the unit to set the movement alert.

9.6.2 Cancel: Send SMS nomove+password to deactivate the movement alert.

This function will be out of effect after the unit moves outside the district.

Response SMS format: move!+geo-info. It will alarm one time in each setting.

9.7 Overspeed Alert:

This function is using for the owner to control the target's speed.

9.7.1 Setup: Send SMS speed+password+space+080 to the unit (suppose the speed is 80km/h), and it will reply "speed ok!". When the target moves exceeding 80 km/h, the unit will send SMS speed+080!+Geo-info to the authorized numbers. It will keep sending such an alert every 3 minutes.

9.7.2 Cancel: Send SMS nospeed+password to deactivate the overspeed alert

Remark: It is recommended that the speed alarm is set at not less than 50km/h. For below that rate, it may cause the excursion of the GPS signal influenced by clouds etc.

Response SMS format: speed+080!+Geo-info (suppose the speed is 80km/h).

The tracker will check the speed in 3 minutes interval and alarm if it is overspeed.

9.8 IMEI Checking:

Send SMS imei+password to the unit to check the IMEI number of the unit.

9.9 SOS Button

Press the SOS for 3 second, it will send "help me !+ Geo-info" to all the authorized numbers every 3 minutes. It will stop sending such a SMS when one of the authorized number reply SMS "help me!" to the tracker.

9.10 Low Battery Alert

It begins to send SMS to the user every 30minutes when the the battery voltage is lower than 3.7V.

SMS format: low battery+Geo-info.

9.11 SMS Center (or appointed number)

9.11.1 Setup: Send SMS adminsms+password+space+cell phone number to setup the SMS center.

If the SMS center is set up, when an authorized number sends SMS or makes a call to the tracker, the tracker will reply a SMS with Geo-info & authorized number to SMS center.

9.11.2 Cancel: Send SMS noadminsms+password to cancel the SMS center.

Response SMS format: authorized number+Geo-info

Note:

◆The SMS message must in Text format, can't be identified for PDU format.

◆Power on the tracker outdoor when use the tracker for the first time, it can search the GPS signal nearby, it also greatly shorten the time of searching the GPS signal for the future use.

9.12 GSM ID (this function can be add or delect for customization.)

There is GSM ID in each SMS from the tracker. The location of the tracker can be found according to the GSM ID in case of no GPS signal. GSM ID is make up of MCC(Mobile Country Code),MNC(Mobile Network Code),LAC(Location area code) and Cell ID.(refer to **9.3.4**)

9.13 Motion Sensor (this function can be add or delete for customization.)

This function is using for the user to get alarm info when someone touches the unit.

9.13.1 Setup: Send shake+password+space+1-10 to the tracker to set up this function.(1-10 means the level of intensity)

9.13.2 Send SMS shake+password+space+1 is the lightest level of intensity.the tracker will send alert if someone touches the unit heavily.

9.13.3 Send SMS shake+password+space+10 is the strongest level of intensity.the tracker will send alert if someone touches the unit slightly.

9.13.4 Cancel: Send SMS shake+password+space+0 to remove this function.

9.14 SD Card Function

A mini SD card can be put in the tracker's SD card slot. The GPRS data can be saved in the SD card if GPRS is off. It will send data to the GPRS server again if GPRS is on.

9.14.1 Setup: Send SMS sdlog123456 1 to the tracker to activate the function of storing data in SD card;

Cancel: Send SMS sdlog+password+0 to the tracker to deactivate the function of storing data in SD card.

9.14.2 Setup: Send SMS readsd+password+space+1 to ask the tracker to send data in the SD card to the GPRS server.

Cancel: Send SMS readsd+password+space+0 to ask the tracker to stop sending data in the SD card to the server.

9.15 SIMcard A-B Transformation

9.15.1 If you insert two cards into the tracker,Sim card A and B are not working at the same time,the default working status is sim card B,but they can be transform each other

by hand.

When the sim card B is working,send SMS command selectsim+password+space+a to the sim card B,one minutes later,the sim card A starts to works while sim card B stop working,if you send SMS command selectsim+password+space+b to the sim card A,one minutes later,the sim card B will start to work again instead of sim card A.

9.15.2 If you insert two cards into the tracker,and one of the sim cards has no GSM signal,then the tracker will work with the other automatically.

10 Monitoring Mode(voice surveillance mode)

Send SMS monitor+password, the response from the tracker is “monitor ok” then you can hear the voice around the tracker after your call。

11 Remote Oil&Electricity Cut-off Function

This function is using for the car owner to send a SMS remotely to stop a moving vehicle.

11.1 Setup: Send SMS command powercar123456 11 to the tracker to cut off the oil and electricity of the car to stop the car.

Reply format: powercar ok. You will receive such a reply if the setting is successful.

11.2 Cancel: Send SMS command powercar123456 00 to the tracker to restart the car again.

Reply format: powercar ok. You will receive such a reply if the setting is successful.

12 GPRS Setting

In order to use GPRS function, the user needs to set IP, Port and APN (access point name) by either cell phone, or our PC software.

(NOTE: Some countries or regions should set APN's User Name and APN's

Password.)

12.1 Set an IP address and port:

Setup: Send SMS adminip+123456+space+IP address+space+port.

If setup successful, the tracker will reply SMS “adminip ok”

Cancel: Send SMS noadminip+123456

12.2 Set APN

Setup: Send SMS apn+123456+space+specify apn content.

If setup successful, the tracker will reply SMS “APN ok”.

Cancel: The old APN will be invalid automatically when a new APN is set.

12.3 Set APN's User Name

Setup: Send SMS apnuser+123456+space+the APN's user name.

If setup successful, the tracker will reply SMS “apnuser ok”.

Cancel: The old APN user name will be invalid automatically when a new APN user name is set.

12.4 Set APN's Password

Setup: Send SMS apnpasswd+123456+space+the APN's password.

If setup successful, the tracker will reply SMS “apnpassword ok”.

Cancel: The old APN password will be invalid automatically when a new APN password is set.

12.5 GPRS transport protocols

As soon as the IP & Port & APN are set up, the user can make a call or send SMS to tracker. The tracker will hand up and report the coordinates to IP address.

The message format sent by tracker to IP address is as following:

Serial number + authorized number + GPRMC + GPS signal indicator + command + IMEI number + CRC16 checksum.

For example:

```
090907070718,13145826175,GPRMC,070718.000,A,2234.0228,N,11403.0764,E,0.00  
,,070909,,,A*73,F,,imei:354776030042714,05,50.1,F:4.11V,0,132,40512,460,01,2533,7  
20B
```

090907070718== serial number(date&time)

13145826175=== authorized number

GPRMC,070718.000,A,2234.0228,N,11403.0764,E,0.00,,070909,,,A*73,==GPS

module's Original GPRMC sentences

F=== Full GPS signal L=== No GPS signal

imei:354776030042714==the tracker's IMEI number

05===get 5 GPS number

50.1=== Altitude

F:4.11V===Full battery power L:3.65V===Low battery power

0===No charging 1===charging

132=== The length of the GPRS string

40512===CRC16 Checksum

460===460 = MCC Mobile Country Code

01==MNC Mobile Network Code

2533==2533= LAC Location area code

720C==720B= Cell ID

(NOTE:GSM ID can be add or delect accroding to customer;s requirement.)

For example, it will send GPS coordinates as below illustrated

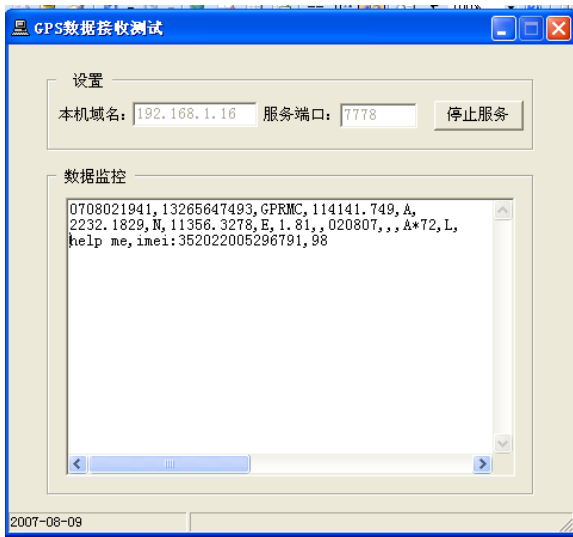

Notes:

- ◆ Our gprs supports TCP or UDP protocol, so please confirm whether your GPRS webserver supports TCP or UDP protocol before having the order.
- ◆ Please use the SIM card which is with GPRS function.
- ◆ Pls use the following SMS to set up GMT time in the SMS for the tracker
time zone+password+space+ the customer's GMT TIME
- ◆ Pls use the following SMS to set up YOUR website in the SMS for the tracker
home+password+space+ the customer's WEBSITE
home+password+space+space (if there is no website in the SMS)

13 Cautions

Please comply with the instructions to extend the unit life:

1. Keep the unit dry. Any liquid, i.e. rain, moisture, may destroy or damage the inside circuitry.
2. Don't use & store the unit in dusty places.
3. Don't put the unit in overheated or overcooled places.
4. Handle carefully. Don't vibrate or shake it violently.
5. Clear the unit with a piece of dry cloth. Don't clean in chemicals, detergent.

6. Don't paint the unit, this may cause some foreign materials left in between the parts.
7. Don't disassemble or refit the unit.
8. Please use the battery and charger provided by manufacturer. Using other batteries and chargers will cause unwanted situation.
9. Don't dismount the antenna randomly, or use other antennas. This may interfere the transmission, and increase the radiation as well.

14 Faults & Solutions

Faults	Solutions
Startup Fail	Check the battery to see if it is fully charged or correctly installed.
Hangup Fail	In existence of an authorized number, an unauthorized number dials up the unit. Please initialize the unit and re-set up the authorized numbers.
Monitor Fail	Check if the authorized number is setup or in the coverage of signals.
Indicator keep on flashing quickly	Check the SIM card to see if it is put in place.
SD card stroing data fail	Chack the SD card to see if it is put in place.
Location report in digits of zeros.	Don't use it in the place beyond reach of signals. Place the unit outdoors, especially when starting it up.

(Remark: There are two ways for the times of sending alarm in each setting.one time and heap of times,which is according to the customer's requirements;This product also supports sending commands by GPRS server and by USB cable,which the same as SMS commands.)