

RESMED

H4i™ User Guide

English



RESMED

H4iTM

HEATED HUMIDIFIER

User Guide

English

Manufacturer:

ResMed Ltd 1 Elizabeth Macarthur Drive Bella Vista NSW 2153 Australia.

Distributed by:

ResMed Corp 9001 Spectrum Center Boulevard San Diego CA 92123 USA.

ResMed (UK) Ltd 96 Milton Park Abingdon Oxfordshire OX14 4RY UK.

See www.resmed.com for other ResMed locations worldwide.

Patents pending.

Protected by design registrations: US D557406, US D557407, US D592301, US D612480. Other designs pending.

H4i, S8, Stellar and VPAP are trademarks of ResMed Ltd and VPAP is registered in U.S. Patent and Trademark Office.

© 2010 ResMed Ltd. 248347/1 2010-10

Contents

Introduction	1
Indications for use	1
Contraindications	1
Components of your H4i	1
Setting up your H4i for use	1
Preparation	1
System setup	2
Filling the water chamber	3
Detaching your H4i	3
Starting and stopping treatment	4
Warming your H4i with the VPAP or S8 Series	4
Warming your H4i with the Stellar 150	4
Starting your treatment	4
Stopping your treatment	5
Cleaning and maintenance	5
Disassembling the H4i cleanable water chamber	5
Cleaning your H4i	6
Reassembling the H4i cleanable water chamber	7
Reassembling your H4i	8
Servicing	8
Frequently asked questions	8
Troubleshooting	9
Technical specifications	10
Humidifier performance	10
Symbols which appear on the device	11
General warnings	11
Limited warranty	12

Introduction

The H4i™ is designed to moisten the air delivered to your airway during Positive Airway Pressure (PAP) therapy.

Indications for use

The H4i is indicated for humidification of the air delivered from a ResMed compatible CPAP, bilevel or non-invasive ventilation device. The H4i is for use only as recommended by a physician.

Contraindications

The H4i is contraindicated for use with patients whose upper (supraglottic) airway has been bypassed. Please also refer to the relevant system manual for contraindications associated with PAP therapy.

Components of your H4i

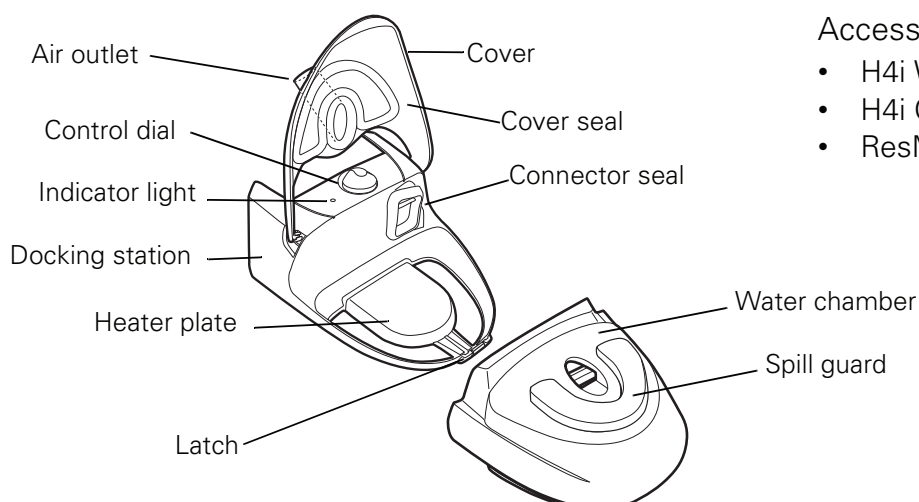

Accessories:

- H4i Water Chamber
- H4i Cleanable Water Chamber
- ResMed Tubing Wrap

Setting up your H4i for use

Preparation

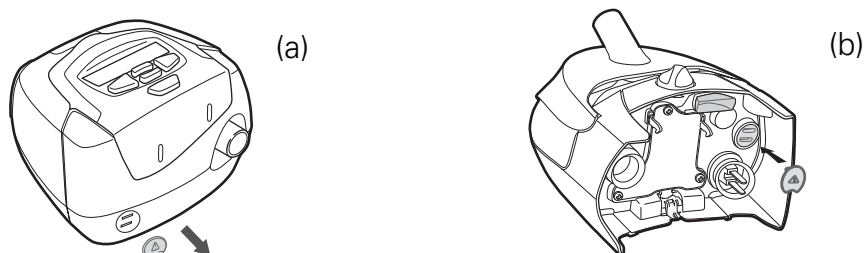

Remove the connector plug from your flow generator **(a)** and attach it to the back of the docking station **(b)**.

System setup

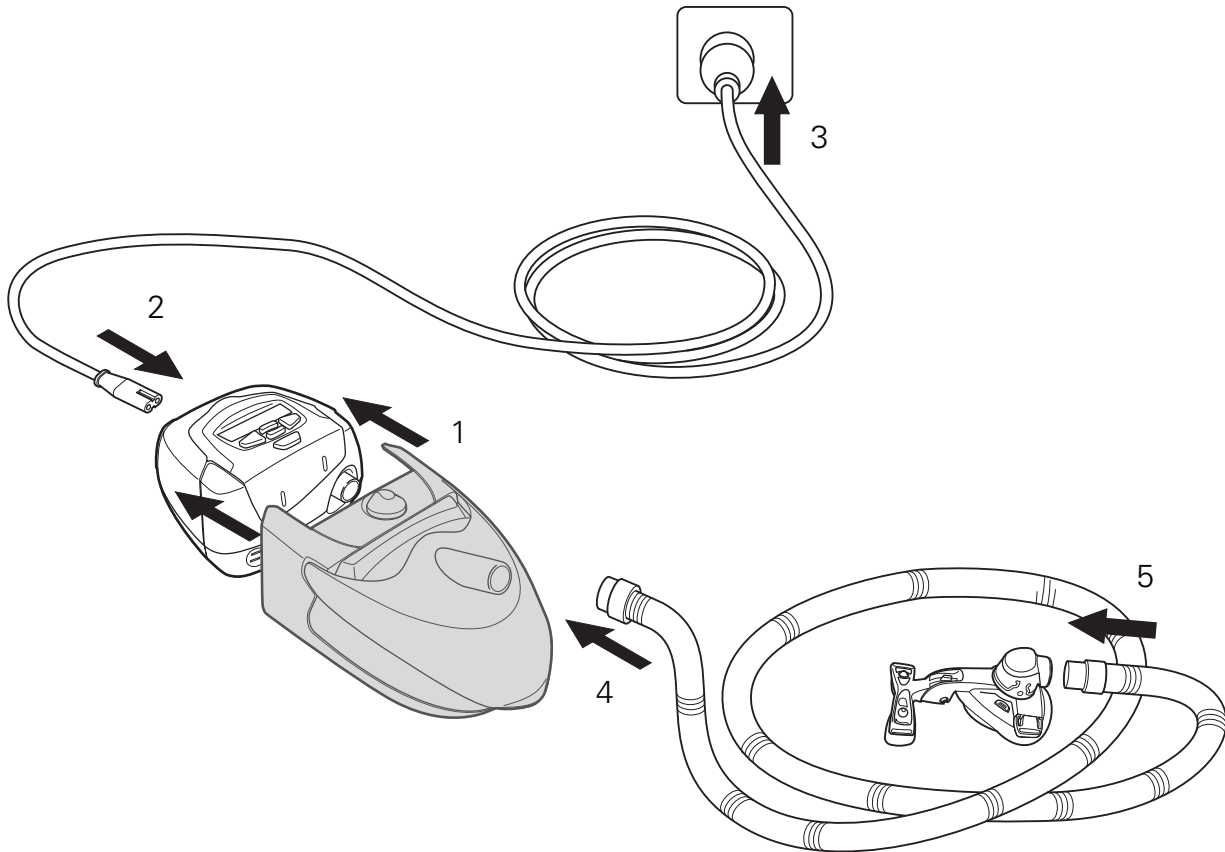

- 1** Align your H4i with your flow generator and push them together until they click into place.
- 2** Connect the power cord to the socket on the rear of your flow generator.
- 3** Plug the other end of the power cord into the power outlet.
Place the combined unit on a firm, level surface near your bed at a level lower than your sleeping position. Ensure the surface is not sensitive to heat and/or moisture, or use a protective mat.
- 4** Connect one end of the air tubing firmly onto the air outlet.
- 5** Connect the assembled mask system to the free end of air tubing.

WARNING



- Make sure your flow generator is switched off at the power outlet before connecting the H4i.
- The H4i docking station should only be connected or disconnected when the water chamber is empty.
- Water must be prevented from entering your flow generator. Do not transport the flow generator with the H4i attached.
- The H4i is contraindicated for invasive use. An external humidifier approved for invasive use is recommended according to EN ISO 8185.

Filling the water chamber

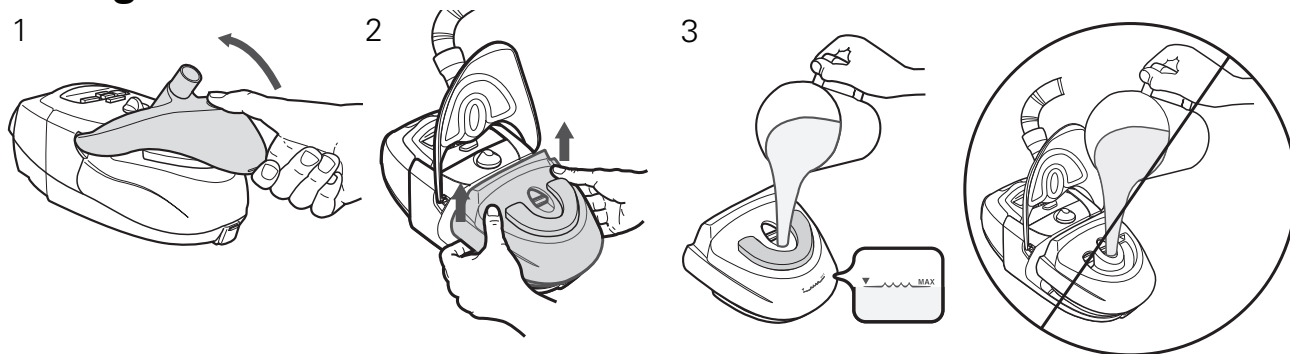

- 1** Open the cover.
- 2** Remove the water chamber.
- 3** Fill with fresh, clean water up to or below the maximum water level mark.

Note: The water chamber **must** be removed from the H4i before it is filled or water may enter the flow generator. The spill guard must also be in place.

- 4** Return the water chamber to the docking station.
Note: Ensure that no water is collected between the heater plate and the water chamber.
- 5** Close the cover ensuring that it clicks into place.



CAUTION

- Do not overfill the water chamber as water may enter the flow generator and air tubing.
- Do not use any additives (eg, scented oils and perfumes). They may reduce the humidification output of the H4i and/or cause deterioration of the water chamber materials.

Detaching your H4i

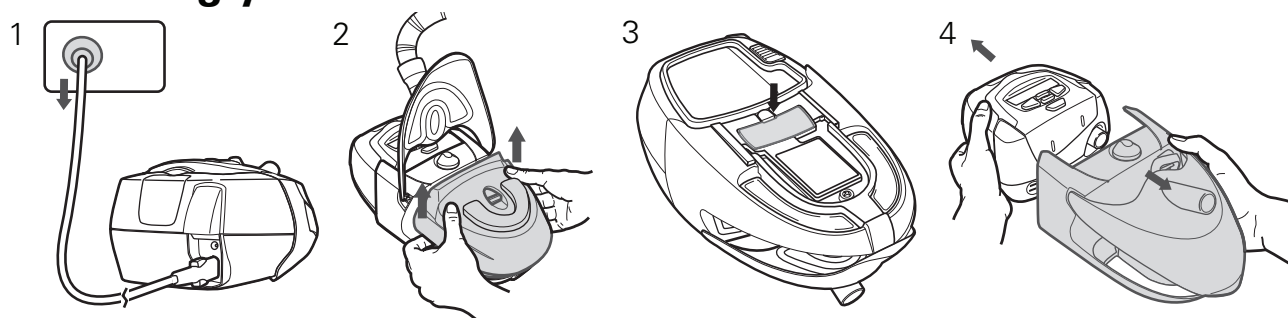

- 1** Unplug the power cord from the power outlet.



WARNING

Take care when handling your H4i. The water and the water chamber base may both be hot. Allow 10 minutes for the heater plate and any excess water to cool.

- 2** Remove the water chamber from the docking station.
- 3** Press the **large silver button** located midway **underneath** the docking station.





- 4 Pull the H4i and flow generator apart.

Note: Re-attach the connector plug firmly to your flow generator.

Starting and stopping treatment

Warming your H4i with the VPAP or S8 Series

The Warm-Up feature (not available on all ResMed PAP devices) is used to pre-heat the water before starting treatment. Skip this step if you want to start immediately. To start the Warm-Up feature:

- 1 Select **warmup** by pressing  on the control panel.
- 2 The WARMING screen will appear to indicate that the Warm-Up feature is activated.
- 3 While your H4i is in Warm-Up mode you can:
 - Start treatment at any time by pressing .
 - Access the menus by pressing .
 - Stop the Warm-Up feature at any time by pressing . (This may not apply on all devices.)

The Warm-Up feature will automatically turn off after 30 minutes if treatment has not started.

Warming your H4i with the Stellar 150

Your H4i will be automatically detected when the Stellar 150 is turned on. The treatment screen will give you the option to start warming up the humidifier prior to starting treatment. If the humidifier is heating, the related symbol is displayed at the top of the LCD screen.

Note: The H4i can only be used when the device is connected to mains power supply.



CAUTION

H4i cannot be used for treatment pressures exceeding 25 cm H₂O.

Starting your treatment

- 1 Turn the humidity control dial to three (|||). You can adjust the control dial up or down at any time to find the setting that is most comfortable for you. The ○ setting switches heated humidification off and delivers minimum humidification while a setting of six (|||||) delivers maximum humidification.

Note: The ResMed Tubing Wrap is designed to enhance comfort by maximising heat retention along the air tube.

- 2 Start treatment as described in your device user guide.

Note: The H4i is thermostatically controlled to maintain a constant temperature. The indicator light will brighten to indicate when the device is actively heating and dim when it has reached its set temperature.

- 3 Lie down and arrange the tubing so that it moves freely when you turn in your sleep.

**WARNING**

Do not leave an excessive length of air tubing around the top of your bed. It could twist around your head or neck while you are sleeping.

Stopping your treatment

To stop treatment, refer to your device user guide.

Note: In order to assist the heater plate in cooling, some flow generators continue to blow air gently for up to an hour after treatment has stopped. However, you can unplug the device from the power outlet at any time and allow the heater plate to cool without airflow.

Cleaning and maintenance

You should regularly carry out cleaning and maintenance of the water chamber, cover and cover seal as described in this section.

**WARNING**

- Beware of electrocution. Do not immerse your flow generator, docking station or power cord in water. Always unplug the device before cleaning and be sure that it is dry before plugging it back in.
- Take care when handling your H4i. The water and the water chamber base may both be hot. Allow 10 minutes for the heater plate and any excess water to cool.

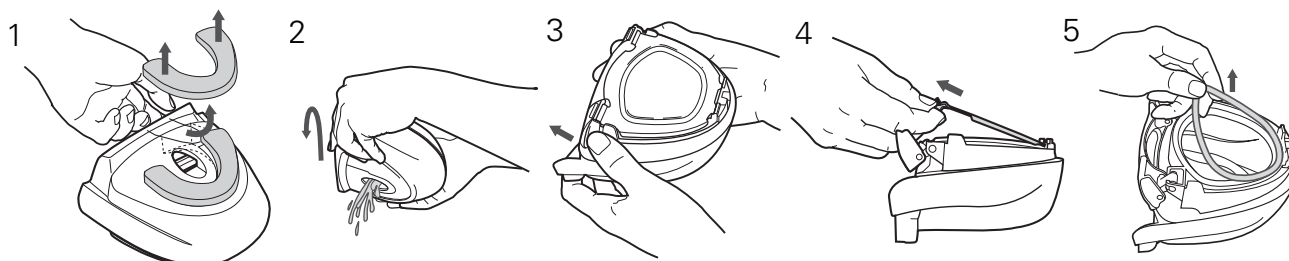
Disassembling the H4i cleanable water chamber

- 1** Remove the spill guard by pushing up from inside the air inlet and pulling it away from the water chamber.
- 2** Discard any excess water from the water chamber.
- 3** Turn the water chamber upside down. Using the side tabs, disengage the latch by pushing the latch up and away.
- 4** Remove the tub plate.
- 5** Remove the tub plate seal.

Note: Only the H4i Cleanable Water Chamber can be disassembled/reassembled.

Cleaning your H4i

Water chamber

Daily

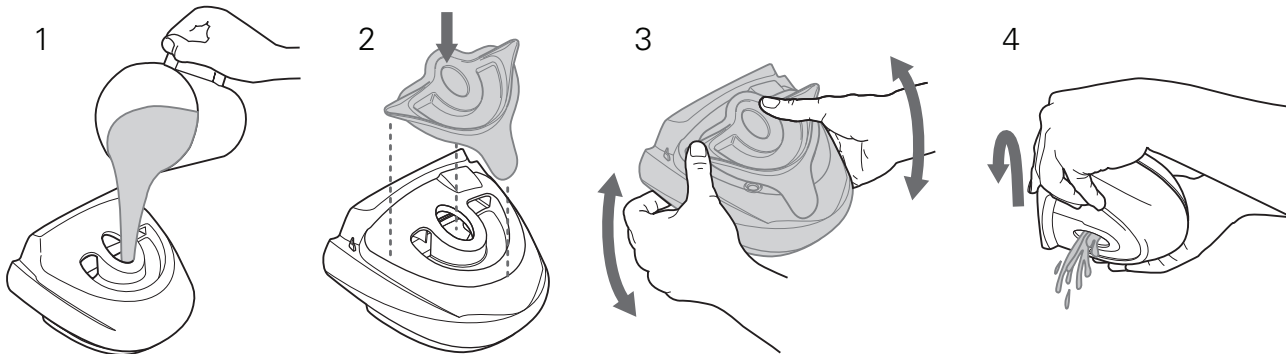

Wash the water chamber, spill guard, tub plate and tub plate seal in warm water, using a mild detergent. Use the yellow cleaning plug to assist in the cleaning process (see steps 1 to 4). Rinse thoroughly in clean water and allow them to dry away from direct sunlight.

Weekly

The disassembled cleanable water chamber, spill guard, tub plate and tub plate seal may be washed in a dishwasher on the delicate or glassware cycle (top shelf only).

Note: *Not applicable to the H4i Water Chamber.*

Inspect the water chamber for wear and deterioration. Replace the water chamber if any component has cracked, become cloudy or pitted. Replace immediately if there is any leaking from the water chamber.

White powder or deposits in the water chamber can be cleaned using a solution of one part vinegar to 10 parts water, as follows:

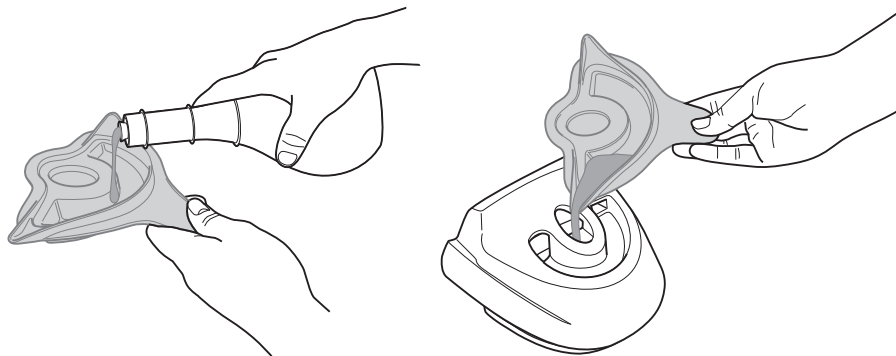

- 1** Fill the cleaning plug to the rim with vinegar and pour into empty water chamber.
- 2** Add clean water to the water chamber until the solution reaches the maximum water level mark.
- 3** Let the solution soak for 10 minutes.
- 4** Discard the solution and rinse the water chamber with clean water.

Cover and cover seal

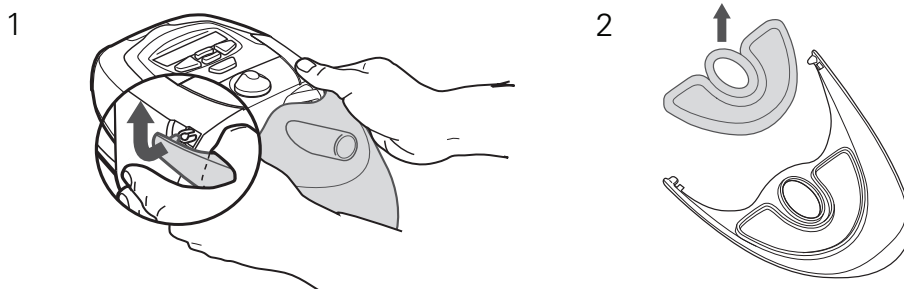

- 1** Remove the cover by gently flexing one cover arm away and up from the docking station until the cover detaches completely.
- 2** Peel the cover seal away from the cover.
- 3** Inspect the cover and cover seal weekly for wear and deterioration. Replace any damaged parts. When required, wash the cover and cover seal in warm water, using a mild detergent. Rinse them thoroughly with clean water and allow it to dry away from direct sunlight.

Docking station

Periodically wipe the outside of the docking station (including the connector seal) with a damp cloth.



CAUTION

Do not use any of the following to clean any part of the H4i as these solutions may cause damage and reduce the life of the product:

- bleach, chlorine-, alcohol- or ammonia-based solutions
- moisturising, antibacterial or glycerine based soaps
- water softening and unapproved descaling agents.

Heater plate

Do not allow water to collect on the heater plate. Wipe it with a clean cloth if necessary.

Reassembling the H4i cleanable water chamber

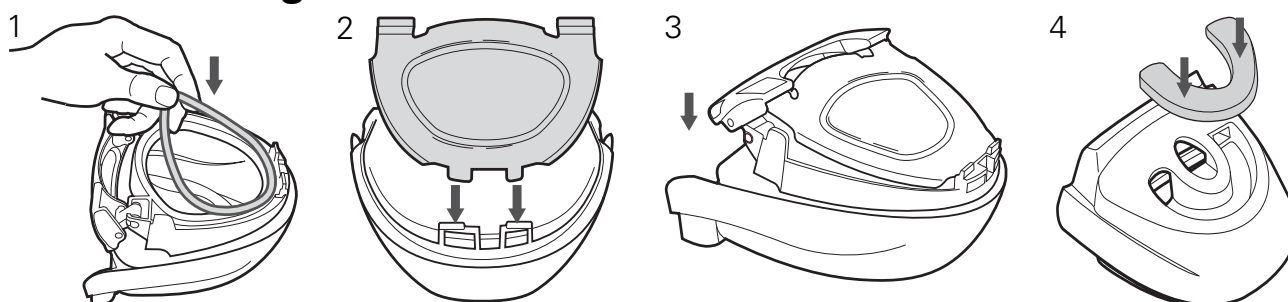

- 1** Refit the tub plate seal into its groove on the cleanable water chamber.
- 2** Reinsert the tub plate by slotting its feet into the catches.
- 3** Reassemble the catch by lifting up and over the water chamber and then pushing down to lock into place.

Note: Only the H4i Cleanable Water Chamber can be disassembled/reassembled.

- 4 Reinsert the spill guard into the water chamber recess and push down to fit firmly into place.

Reassembling your H4i

Reassemble the parts when they are clean and dry.

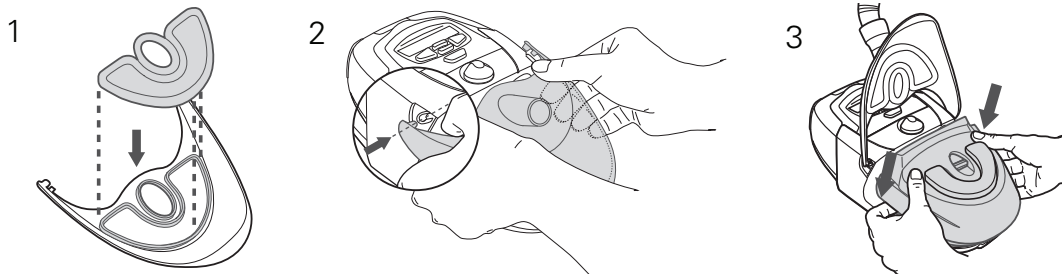

- 1 Align the cover seal to the guides on the cover and press along the edges to ensure it is fitted properly.
- 2 Put one cover arm into its pivot point on the docking station and gently flex the other arm into its corresponding point. The cover should be able to open and close freely while securely attached to the docking station.
- 3 Replace the water chamber in the humidifier docking station.

Servicing

The H4i should be inspected by an authorised ResMed Service Centre five years from the date of manufacture. Prior to this, the device is intended to provide safe and reliable operation provided that it is operated and maintained in accordance with the instructions provided by ResMed. Warranty details are provided with the device at the time of original supply. As with all electrical devices, if any irregularity becomes apparent, you should exercise caution and have the device inspected by an authorised ResMed Service Centre.

Frequently asked questions

Question	Answer
Why is there condensation in my mask and/or air tubing?	Excessive condensation in your mask or air tubing may occur when the room temperature is low. To prevent condensation, turn the control dial down to a lower setting. You may need to adjust your humidity setting from season to season. The use of a ResMed Tubing Wrap can help reduce the effects of condensation.
Do I have to use distilled water in the water chamber?	Using distilled water will maximise the life of the water chamber and reduce mineral deposits.
What if I still have symptoms of dryness?	If you have symptoms of dryness, then your humidity setting may be set too low to be effective. Turn the humidity control dial up. If you are still experiencing symptoms of dryness, you may be breathing through your mouth. Mouth breathing or mouth leaks cause drying and irritation of the upper airway. If this is a problem, a full face mask or chin strap may help. Consult your clinician or equipment supplier for details.

Troubleshooting

If there is a problem, try the following suggestions. If the problem cannot be solved, contact your equipment supplier or ResMed. Do not open the unit.



WARNING

Service and repair should only be performed by an authorised service agent.

Problem	Possible cause	Solution
Device not working (no display on LCD screen and/or indicator light not lighting up)	Power cord is not plugged in properly.	Check that the power cord is plugged firmly into the power outlet and the switch (if available) is on at the outlet.
	Faulty power outlet.	Try another power outlet.
	Flow generator and docking station not connected correctly.	Check that the docking station is securely attached to the flow generator.
Indicator light is permanently dull and/or air does not feel warm	H4i reflector is dirty.	Clean the reflector with a damp cloth.
Leaking water chamber	The water chamber may be damaged or cracked.	Contact your supplier for a replacement.
	The tub plate is not attached correctly (not applicable to the H4i Water Chamber).	Make sure the tub plate is fitted correctly.
No/low air flow	The air tubing is not connected properly.	Connect the air tubing as described in "Setting up your H4i for use" on page 1.
	The air tubing is blocked, pinched or punctured.	Unblock or free the air tubing. Check the air tubing for punctures.
	The flow generator is not working correctly.	See the Troubleshooting section in the flow generator manual.
	The cover is not latched correctly.	Make sure the cover is latched onto the docking station correctly.
	The cover seal is not fitted correctly.	Make sure the cover seal is facing the right way up and fitted securely.
Water splashing on your face	The water chamber is overfilled.	Empty some water from the water chamber.
	Condensation is forming in the air tube and mask.	Turn the control dial down.
		Use the ResMed Tubing Wrap.

Technical specifications

Maximum heater plate temperature	85°C
Temperature cut-out	93°C
Maximum gas temperature	41°C
Dimensions (H x W x D)	Docking station and water chamber: 130 mm x 170 mm x 212 mm
Weight	Docking station and unfilled water chamber: 786 g
Water capacity	To maximum fill line: 390 mL
Power supply	Input range for ResMed devices with H4i: 100–240V, 50/60Hz; 110V, 400Hz; 2.5A <140 VA (110 W) (max. power consumption) Instantaneous peak power consumption <340 VA* Maximum heater element power: 85 W
Docking station	Flame retardant engineering thermoplastic, plated cast aluminium
Water chamber	Injection molded plastic, stainless steel and silicon seal
Operating temperature	+5°C to +35°C
Operating humidity	10–95% non-condensing
Storage and transport temperature	-20°C to +60°C
Storage and transport humidity	10–95% non-condensing
IEC 60601-1 classification	Class II (double insulation), Type CF
Electromagnetic compatibility	Please refer to your flow generator user's manual for details

* Actual average power consumption will vary depending on factors such as temperature setting, set pressure, the use of accessories, height above sea level and ambient temperature.

Humidifier performance

The following settings have been tested at 22°C, 40% RH ambient conditions:





CPAP mask pressure cm H ₂ O	RH output %		Nominal system output AH*, BTPS†	
	Setting 3	Setting 6	Setting 3	Setting 6
4	>95	>95	16	20
10	>85	>95	14	18
20	>75	>85	13	16



* AH- Absolute Humidity in mg/L.

† BTPS- Body Temperature Pressure Saturated.

Note: The manufacturer reserves the right to change these specifications without notice.

Symbols which appear on the device

 Caution;  Follow instructions for use;  Type CF equipment;  Hot surface;

 Class II equipment;  Do not touch;  Humidifier control;

 ^{MAX} Maximum water level.

General warnings



A warning alerts you to possible injury. Specific warnings and cautions appear next to the relevant instructions in the manual.

- Use the H4i only for its intended use as described in this manual.
- Make sure that the water chamber is empty before transporting the H4i.
- The H4i is designed only for use with specific ResMed PAP devices. Do not use the H4i with any other PAP device.
- The H4i should only be used with delivery tubes or accessories recommended by ResMed. Connection of other delivery tubes or accessories could result in injury, or damage to the device.
- The H4i, including the associated tubing, is for single-patient use and must not be re-used on another person. This is to avoid the risk of cross-infection.
- There exists the possibility that if the device is placed above the level of the patient and is tipped over, or if the tubing is filled with condensate, the mask might fill with heated water. The H4i should therefore be used with caution in patients who are unable to guard their airways, or are unable to pull the mask off, for example following a stroke. Attention should be given to the relative risks and benefits.
- Do not attempt to dismantle the H4i docking station. There are no user-serviceable parts inside. Repairs and internal servicing should only be performed by an authorised service agent.
- If liquids are inadvertently spilled into or on the H4i docking station, unplug the PAP device from the power outlet. Disconnect the docking station from the PAP device and allow the docking station to drain and dry before using.
- Do not operate the H4i if it is not working properly or if any part of the PAP device or H4i has been dropped or damaged.
- Keep the PAP device power cord away from hot surfaces.
- Do not drop or insert any object into any opening or tubes.
- Do not use the H4i in the presence of flammable or explosive materials.
- Explosion hazard—do not use in the vicinity of flammable anesthetics.
- Follow all precautions when using supplemental oxygen.

Limited warranty

ResMed Ltd (hereafter 'ResMed') warrants that your ResMed product shall be free from defects in material and workmanship from the date of purchase for the period specified below.

Product	Warranty period
<ul style="list-style-type: none"> • Mask systems (including mask frame, cushion, headgear and tubing)—excluding single-use devices • Accessories—excluding single-use devices • Flex-type finger pulse sensors • Humidifier water tubs 	90 days
<ul style="list-style-type: none"> • Batteries for use in ResMed internal and external battery systems 	6 months
<ul style="list-style-type: none"> • Clip-type finger pulse sensors • CPAP and bilevel device data modules • Oximeters and CPAP and bilevel device oximeter adapters • Humidifiers and humidifier cleanable water tubs • Titration control devices 	1 year
<ul style="list-style-type: none"> • CPAP, bilevel and ventilation devices (including external power supply units) • Battery accessories • Portable diagnostic/screening devices 	2 years

This warranty is only available to the initial consumer. It is not transferable.

If the product fails under conditions of normal use, ResMed will repair or replace, at its option, the defective product or any of its components.

This limited warranty does not cover: a) any damage caused as a result of improper use, abuse, modification or alteration of the product; b) repairs carried out by any service organization that has not been expressly authorized by ResMed to perform such repairs; c) any damage or contamination due to cigarette, pipe, cigar or other smoke; and d) any damage caused by water being spilled on or into an electronic device.

Warranty is void on product sold, or resold, outside the region of original purchase.

Warranty claims on defective product must be made by the initial consumer at the point of purchase.

This warranty replaces all other expressed or implied warranties, including any implied warranty of merchantability or fitness for a particular purpose. Some regions or states do not allow limitations on how long an implied warranty lasts, so the above limitation may not apply to you.

ResMed shall not be responsible for any incidental or consequential damages claimed to have resulted from the sale, installation or use of any ResMed product. Some regions or states do not allow the exclusion or limitation of incidental or consequential damages, so the above limitation may not apply to you.

This warranty gives you specific legal rights, and you may also have other rights which vary from region to region. For further information on your warranty rights, contact your local ResMed dealer or ResMed office.

Filling the water chamber

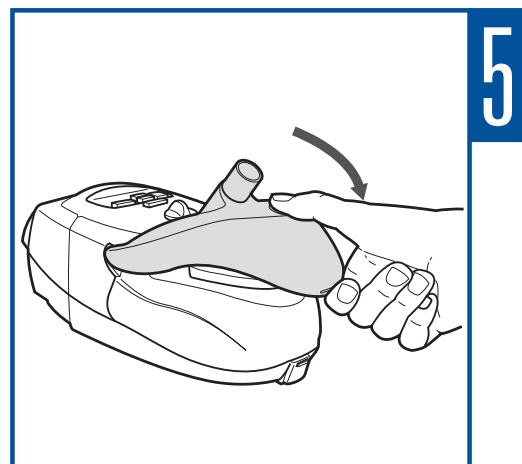
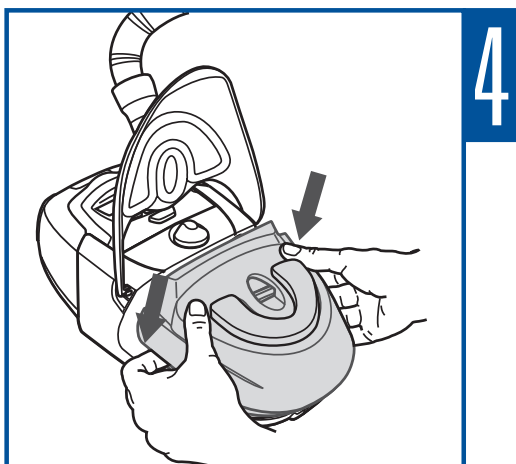
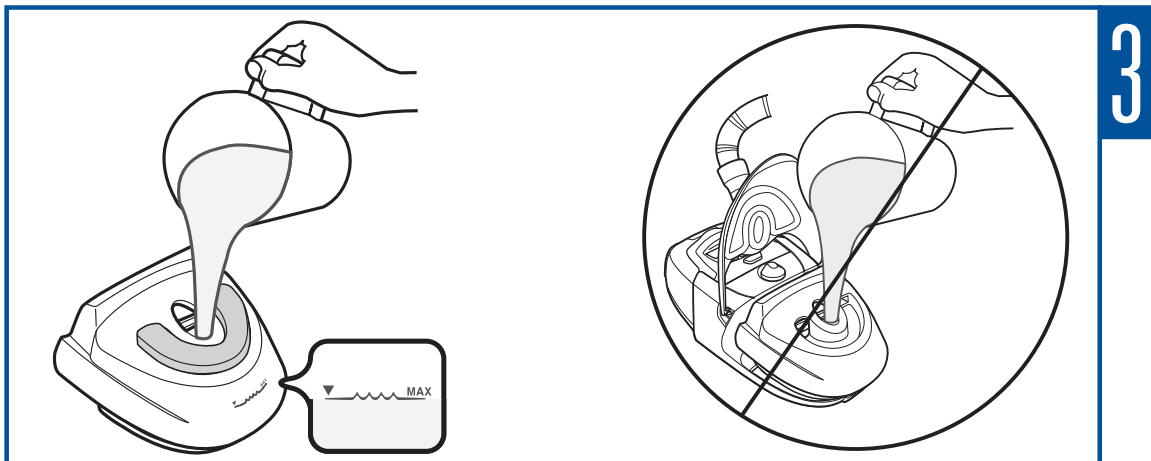
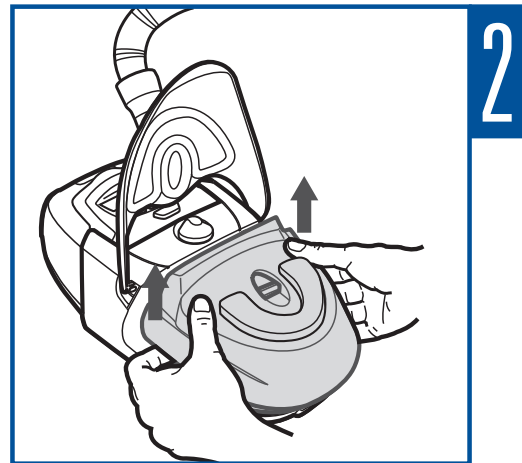
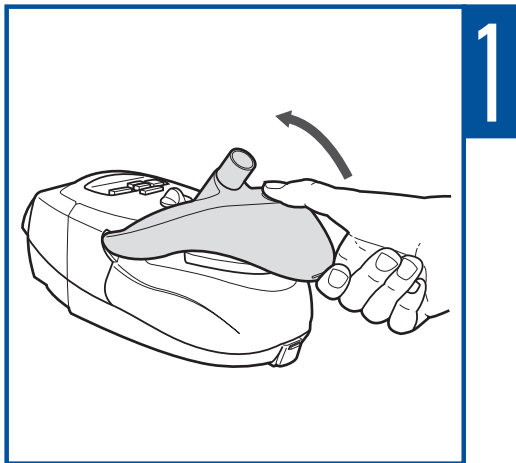

248347/1 2010-10
H4i
USER
ANZ