

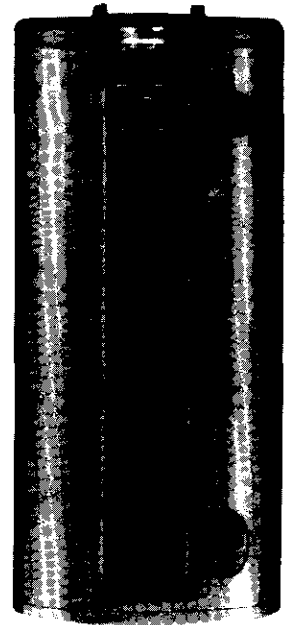

MAYTAG



Series Twelve PC INTELLIGENT ELECTRIC WATER HEATER USER'S GUIDE

Model Numbers

HE21250PC
HE21282PC



GAMA certification applies to all residential electric water heaters with capacities of 20 to 120 Gallons. Input rating of 12 Kw or less at a voltage no greater than 250 V.

▲ WARNING

READ THE GENERAL SAFETY SECTION BEGINNING ON INSIDE COVER AND THEN THIS ENTIRE MANUAL BEFORE INSTALLING OR OPERATING THIS WATER HEATER.

Save this Manual for Future Reference.

**FOR POTABLE WATER
HEATING ONLY**

**NOT SUITABLE FOR
SPACE HEATING**

**Caution:
Read and Follow All
Safety Rules and
Operating Instructions
Before First Use of
This Product.**

Safety Instructions

▲ WARNING

Improper installation, adjustment, alteration, service or maintenance can cause DEATH, SERIOUS BODILY INJURY, OR PROPERTY DAMAGE. Refer to this manual for assistance consult your local utility or call Maytag Customer Service at 1-800-788-8899 for an authorized servicer for further information.

▲ WARNING

HAZARD OF ELECTRICAL SHOCK! Before removing any access panels or servicing the water heater, make sure the electrical supply to the water heater is turned "OFF". Failure to do this could result in DEATH, SERIOUS BODILY INJURY, OR PROPERTY DAMAGE.

▲ WARNING

HOTTER WATER CAN SCALD: Water heaters are intended to produce hot water. Water heated to a temperature which will satisfy clothes washing, dish washing, and other sanitizing needs can scald and permanently injure you upon contact. Some people are more likely to be permanently injured by hot water than others. These include the elderly, children, the infirm, or physically/mentally handicapped. If anyone using hot water in your home fits into one of these groups or if there is a local code or state law requiring a certain temperature water at the hot water tap, then you must take special precautions. In addition to using the lowest possible temperature setting that satisfies your hot water needs, a means such as a mixing valve, should be used at the hot water taps used by these people or at the water heater. Mixing valves are available at plumbing supply or hardware stores. Follow manufacturers instructions for installation of the valves. Before changing the factory setting on the thermostat, read the "Temperature Regulation" section in this manual.

▲ WARNING

INSULATING JACKETS: When installing an external water heater insulation jacket on an electric water heater:

- DO NOT cover the temperature-pressure relief valve.
- DO NOT put insulation over the access covers or any access areas.
- DO NOT cover or remove operating instructions, and safety related warning labels and materials affixed to the water heater.

▲ WARNING

Do not use this appliance if any part of it has been under water. An electrical short or malfunction could occur. The water heater should be replaced.

▲ WARNING

At the time of manufacture this water heater was provided with a combination temperature-pressure relief valve certified by a nationally recognized testing laboratory that maintains periodic inspection of production of listed equipment or materials, as meeting the requirements for Relief Valves and Automatic Gas Shutoff Devices for Hot Water Supply Systems, and the latest edition of ANSI Z21.22 and the code requirements of ASME. If replaced, the valve must meet the requirements of local codes, but not less than a combination temperature and pressure relief valve certified as meeting the requirements for Relief Valves and Automatic Gas Shutoff Devices for Hot Water Supply Systems, ANSI Z21.22 by a nationally recognized testing laboratory that maintains periodic inspection of production of listed equipment or materials.

The valve must be marked with a maximum set pressure not to exceed the marked hydrostatic working pressure of the water heater (150 lbs./sq. in.) and a discharge capacity not less than the water heater input rate as shown on the model rating plate. (Electric heaters - watts divided by 1000 x 3415 equal BTU/Hr. rate.)

Your local jurisdictional authority, while mandating the use of a temperature-pressure relief valve complying with ANSI Z21.22 and ASME, may require a valve model different from the one furnished with the water heater.

Compliance with such local requirements must be satisfied by the installer or end user of the water heater with a locally prescribed temperature-pressure relief valve installed in the designated opening in the water heater in place of the factory furnished valve.

For safe operation of the water heater, the relief valve must not be removed from its designated opening or plugged.

The temperature-pressure relief valve must be installed directly into the fitting of the water heater designated for the relief valve. Position the valve downward and provide tubing so that any discharge will exit only within 6 inches above, or at any distance below the structural floor. Be certain that no contact is made with any live electrical part. The discharge opening must not be blocked or reduced in size under any circumstances. Excessive length, over 30 feet, or use of more than four elbows can cause restriction and reduce the discharge capacity of the valve.

No valve or other obstruction is to be placed between the relief valve and the tank. Do not connect tubing directly to discharge drain unless a 6" air gap is provided. To prevent bodily injury, hazard to life, or property damage, the relief valve must be allowed to discharge water in quantities should circumstances demand. If the discharge pipe is not connected to a drain or other suitable means, the water flow may cause property damage.

The Discharge Pipe:

- Must not be smaller in size than the outlet pipe size of the valve, or have any reducing couplings or other restrictions.
- Must not be plugged or blocked.
- Must be of material listed for hot water distribution.
- Must be installed so as to allow complete drainage of both the temperature-pressure relief valve, and the discharge pipe.
- Must terminate at an adequate drain.
- Must not have any valve between the relief valve and tank.

Safety Instructions (cont'd)

▲ WARNING

WATER HEATERS EQUIPPED FOR ONE VOLTAGE ONLY: This water heater is equipped for one type voltage only. Check the rating plate near the bottom access panel for the correct voltage. **DO NOT** use this water heater with any voltage other than the one shown on the model rating plate. Failure to use the correct voltage can cause problems which can result in **DEATH, SERIOUS BODILY INJURY, OR PROPERTY DAMAGE.** If you have any questions or doubts consult your electric company.

▲ CAUTION

WATER HEATERS EVENTUALLY LEAK: Installation of the water heater must be accomplished in such a manner that if the tank or any connections should leak, the flow of water will not cause damage to the structure. For this reason, it is not advisable to install the water heater in an attic or upper floor. When such locations cannot be avoided, a suitable drain pan should be installed under the water heater. Drain pans are available at your local hardware store. Such a drain pan must have a minimum diameter of at least 1 $\frac{3}{4}$ inches greater than the water heater diameter and must be piped to an adequate drain. Under no circumstances is the manufacturer to be held liable for any water damage in connection with this water heater.

Table of Contents

- Safety Instructions2-3
- Table of Contents4
- Customer Information5
- Product Specifications5
- Accessories and Tools Needed6
 - Accessories6
 - Tools6
- Instructions for Installation7-22
 - Removing the Old Water Heater7
 - Locating the New Water Heater8
 - Typical Installation8
 - The Convertible Lower Element9
 - Water Piping10
 - Temperature-Pressure Relief Valve11
 - Filling the Water Heater12
 - Converting the Lower Element12-14
 - Wiring Diagram15
 - Wiring16
 - Selecting Thermostat Location17
 - Routing Wire Harness to Location17
 - Thermostat Removal17,18
 - Remote Thermostat Wiring at Water Heater18-20
 - Remote Thermostat Installation and Wiring20,21
 - Installation Checklist22
- Instructions for Operation23-26
 - Temperature Regulation23
 - Temperature Conditions23
 - Programming the Thermostat23-26
- Service and Maintenance27-31
 - Temperature-Pressure Relief Valve Operation27
 - Draining27
 - Element Cleaning and Replacement28-30
 - Drain Valve Washer Replacement31
 - Service31
- Troubleshooting32-35
 - Start Up Conditions32
 - Thermal Expansion32
 - Strange Sounds32
 - Operational Conditions32,33
 - Smelly Water32
 - Air in Hot Water Faucets32
 - Rumbling Noise32
 - High Temperature Shut Off System32,33
 - Not Enough Hot Water33
 - Water is Too Hot33
 - Thermostat Diagnostics34
 - Leakage Checkpoints35
- Repair Parts List37-39
- Warranty40

Customer Information

Thank You for purchasing a Maytag water heater. Properly installed and maintained, it should give you years of trouble free service. It is strongly suggested that this new water heater be professionally installed, call Maytag Customer Service at 1-800-788-8899 for recommended installers.

Abbreviations Found In This Instruction Manual

U.L.- Underwriters Laboratories, 333 Pfingsten Rd., Northbrook, IL 60062

National Electrical Code-This publication is available from your local government or public library or electric company or by writing to U.L. above.

ANSI-American National Standards Institute

- Read the "Safety Instructions" section, pages 2 and 3 of this manual first and then the entire manual carefully. If you don't follow the safety rules, the water heater will not operate properly. It could cause DEATH, SERIOUS BODILY INJURY AND/OR PROPERTY DAMAGE.

This manual contains instructions for the installation, operation, and maintenance of this electric water heater. It also contains warnings throughout the manual that you must read and be aware of. All warnings and all instructions are essential to the proper operation of the water heater and your safety. Since we cannot put everything on the first few pages, **READ THIS ENTIRE MANUAL BEFORE ATTEMPTING TO INSTALL OR OPERATE THE WATER HEATER.**

- The installation must conform with the instructions in this manual; electric company rules; and Local Codes, or in the absence of Local Codes, with the latest edition of the National Electrical Code. This publication is available from your local government or public library or electric company or by writing Underwriters Laboratories, 333 Pfingsten Road, Northbrook, IL 60062.
- If after reading this manual you have any questions or do not understand any portion of the instructions, call Maytag Customer Service at 1-800-788-8899 for an authorized servicer.
- Carefully plan the place where you are going to put the water heater. Correct electrical wiring and connections are very important in preventing death from possible electrical shock and fires. Examine the location to ensure the water heater complies with the "Locating the New Water Heater" section.
- For California installation this water heater must be braced, anchored, or strapped to avoid falling or moving during an earthquake. See instructions for correct installation procedures. Instructions may be obtained from the California office of the State Architect, 400 P Street, Sacramento, CA 95814.
- Massachusetts Code requires this water heater to be installed in accordance with Massachusetts 248-CMR 2.00: State Plumbing Code and 248-CMR 5.00.

Product Specifications

Model	HE21250PC		HE21282PC		
Tank Capacity In Gallons	50		80		
Element Wattage at 240 Volt	Upper	3800		3800	
	Lower	3800	5500	3800	5500
Recovery Rate In Gals Per Hr. @ 90°F Rise	Upper	17.3		17.3	
	Lower	17.3	25	17.3	25
Diameter	22"		26.25"		
Height	58.5"		62"		
Maximum Fuse or Circuit Breaker Size	20	30	20	30	
Minimum Wire Size (Gauge)*	12	10	12	10	

*Wiring size based on standard 60°C copper wire. If distance from fuse box to water heater is more than 90 feet, refer to your local electrical code.

Accessories and Tools Needed

Accessories

To simplify the installation Maytag has available the installation parts shown below. You may or may not need all of these accessories depending on your type of installation. Call Maytag Customer Service at 1-800-788-8899 for an authorized installer.

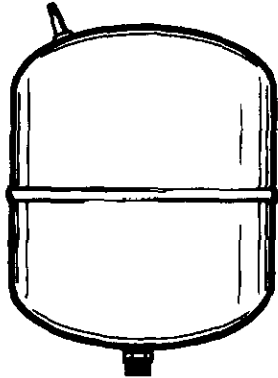

EXPANSION TANKS FOR THERMAL EXPANSION CONDITIONS AVAILABLE IN 2 GALLON (PART NUMBER 66001013) AND 5 GALLON (PART NUMBER 66001014) CAPACITY

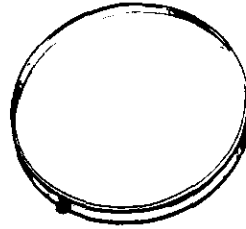

DRAIN PANS AVAILABLE IN 22" DIAMETER (PART NUMBER 66001011) FOR WATER HEATERS HAVING A DIAMETER 20" OR LESS, 24" DIAMETER (PART NUMBER 66001105) FOR WATER HEATERS HAVING A DIAMETER 22" OR LESS AND AVAILABLE IN 28" DIAMETER (PART NUMBER 66001012) FOR WATER HEATERS HAVING A DIAMETER 26.25" OR LESS

Tools

You may or may not need all of these tools, depending on your type of installation. These tools can be purchased at your local Maytag store.

- Pipe Wrenches (2) 14"
- Screwdriver
- 6 Foot Tape of Folding Rule
- Garden Hose
- Drill
- Pipe dope or Teflon Tape



GARDEN HOSE



6 FOOT TAPE

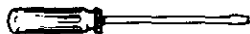

SLOT-HEAD SCREW DRIVER

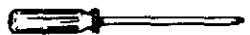

PHILLIPS SCREWDRIVER



PIPE DOPE (SQUEEZE TUBE)



ROLL OF TEFLON TAPE (Use only on water connections)



PIPE WRENCH

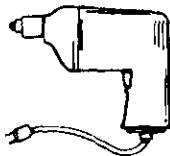

DRILL

ADDITIONAL TOOLS NEEDED WHEN SWEAT SOLDERING

- Tubing Cutters or Hacksaw
- Propane Torch
- Soft Solder
- Solder Flux
- Emery Cloth
- Wire Brushes

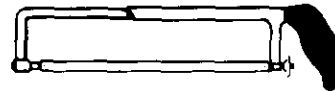

HACKSAW



3/4" WIRE BRUSH



1/2" WIRE BRUSH



ROLL OF LEAD FREE SOFT SOLDER



ROLL OF EMERY CLOTH



SOLDER FLUX



PROPANE TORCH



TUBING CUTTER

Installation Instructions

Removing the Old Water Heater

- ① Turn "OFF" electrical supply to the water heater.

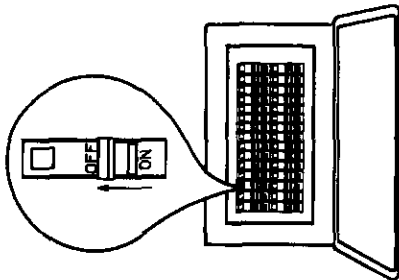

- ② Turn "OFF" the water supply to the water heater at the water shutoff valve or water meter.

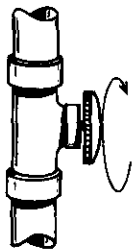

- ③ Attach a hose to the water heater drain valve and put the other end in a floor drain or outdoors. Open the water heater drain valve. Open a nearby hot water faucet which will relieve pressure in the water heater and speed draining.

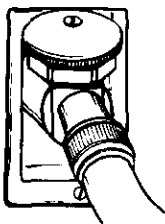

▲ WARNING

The water passing out of the drain valve may be extremely hot. To avoid being scalded, make sure all connections are tight and that the water flow is directed away from any person.

- ④ Check again to make sure the electrical supply is turned "OFF" to the water heater. Then disconnect the electrical supply connection from the water heater junction box.

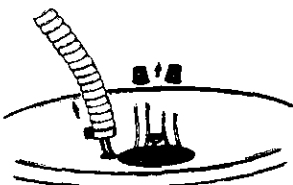

- ⑤ a. If you have copper piping to the water heater, the two copper water pipes can be cut with a hacksaw approximately four inches away from where they connect to the water heater. This will avoid cutting off the pipes too short. Additional cuts can be made later if necessary. Disconnect the temperature-pressure relief valve drain line. When the water heater is drained, disconnect the hose from the drain valve. Close the drain valve. The water heater is now completely disconnected and ready to be removed.

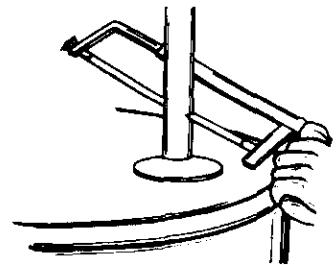
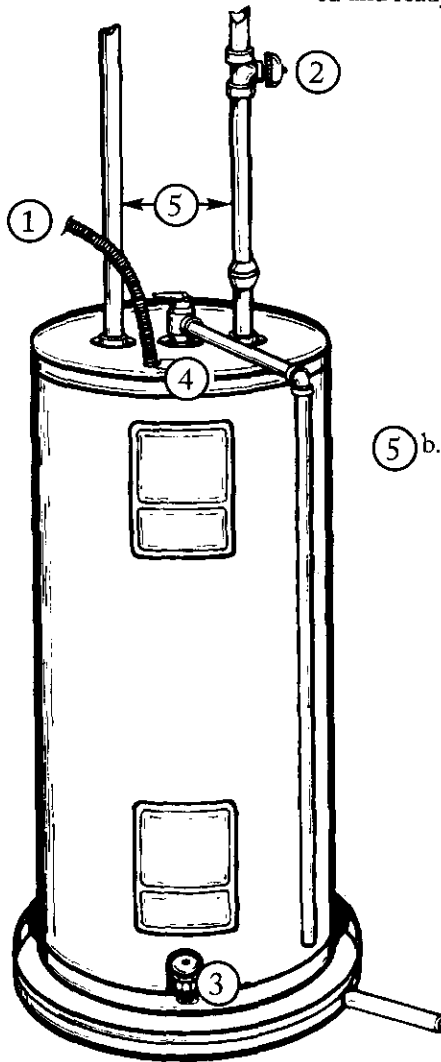

- ⑤ b. If you have galvanized pipe to the water heater, loosen the two galvanized pipes with a pipe wrench at the union in each line. Also disconnect the piping remaining to the water heater. These pieces should be saved since they may be needed when reconnecting the new water heater. Disconnect the temperature-pressure relief valve drain line. When the water heater is drained, disconnect the hose from the drain valve. Close the drain valve. The water heater is now completely disconnected and ready to be removed.

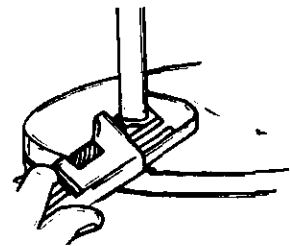

▲ CAUTION

Mineral buildup or sediment may have accumulated in the old water heater. This causes the water heater to be much heavier than normal and this residue, if spilled out, could cause staining.

Instructions for Installation (cont'd)

Locating The New Water Heater

You should carefully choose an indoor location for the new water heater, because the placement is a very important consideration for the safety of the occupants in the building and for the most economical use of the appliance. This water heater is not intended for outdoor installation.

Whether replacing an old water heater or putting the water heater in a new location, the following critical points must be observed.

1. The location selected should be indoors as close to and as centralized with the water piping system as possible. This water heater, as well as all water heaters, will eventually leak. Do not install without adequate drainage provisions where water flow will cause damage.

▲ CAUTION
WATER HEATERS EVENTUALLY LEAK: Installation of the water heater must be accomplished in such a manner that if the tank or any connections should leak, the flow of water will not cause damage to the structure. For this reason, it is not advisable to install the water heater in an attic or upper floor. When such locations cannot be avoided, a suitable drain pan should be installed under the water heater. Drain pans are available at your local hardware store. Such a drain pan must have a minimum diameter of at least 1 ³ / ₄ inches greater than the water heater diameter and must be piped to an adequate drain. Under no circumstances is the manufacturer or Maytag to be held liable for any water damage in connection with this water heater.

▲ CAUTION
INSTALLATION IN RESIDENTIAL GARAGES: The water heater must be located and/or protected so it is not subject to physical damage by a moving vehicle.

2. The location selection must provide adequate clearances for servicing and proper operation of the water heater.

Typical Installation

CHECK ALL CONNECTIONS FOR LEAKS. CONSULT THE LOCAL UTILITY COMPANY TO EXAMINE INSTALLATION FOR PROPRIETY AND SAFETY.

* ▲ WARNING
HOTTER WATER CAN SCALD: Water heaters are intended to produce hot water. Water heated to a temperature which will satisfy clothes washing, dish washing, and other sanitizing needs can scald and permanently injure you upon contact. Some people are more likely to be permanently injured by hot water than others. These include the elderly, children, the infirm, or physically/mentally handicapped. If anyone using hot water in your home fits into one of these groups or if there is a local code or state law requiring a certain temperature water at the hot water tap, then you must take special precautions. In addition to using the lowest possible temperature setting that satisfies your hot water needs, a means such as a mixing valve, should be used at the hot water taps used by these people or at the water heater. Mixing valves are available at plumbing supply or hardware stores. Follow manufacturers instructions for installation of the valves. Before changing the factory setting on the thermostat, read the "Temperature Regulation" section in this manual.

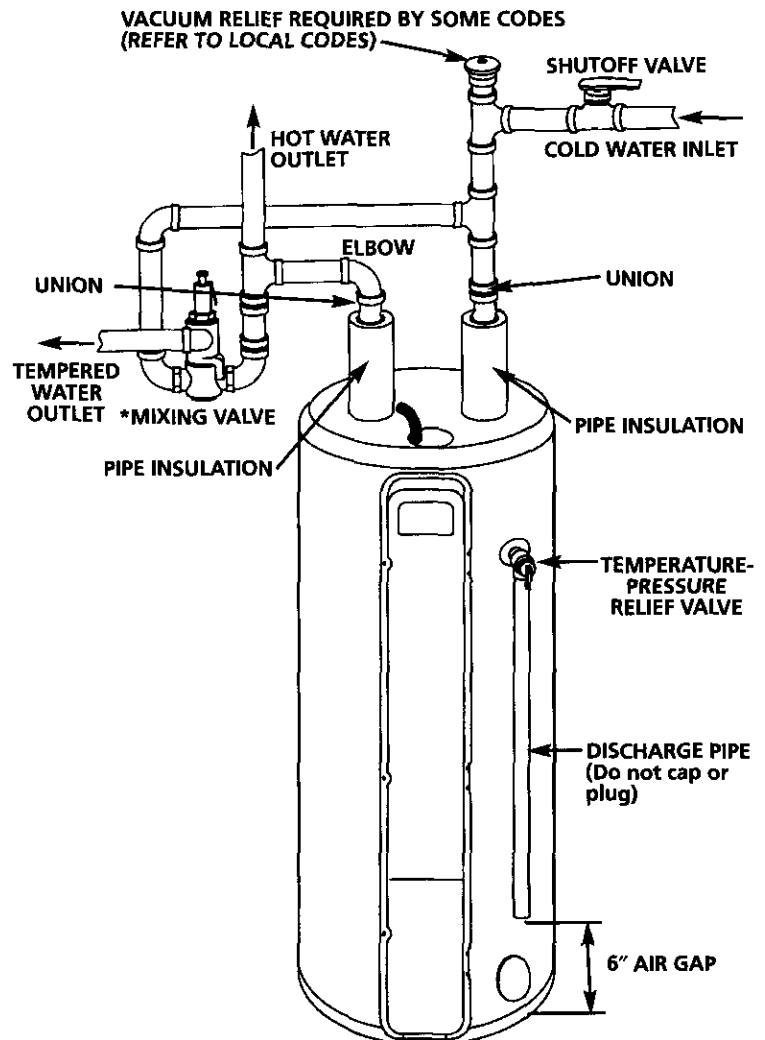

Instructions for Installation (cont'd)

The Convertible Lower Element

The Upper Element, is a conventional 3800 watt element which only operates at its rated wattage on 240 volts. (See rating plate on water heater).

The Lower Element of the water heater can be converted from operation at 3800 watts to 5500 watts on a 240 volt system.

Read and follow water heater warnings and instructions. If after reading these instructions in this manual, if you do not understand any portion, call Maytag Customer Service at 1-800-788-8899 for an authorized servicer.

▲ WARNING
<p>Before making the conversion to 5500 watts, check the (1) power supply...must be 240 volts, (2) wiring...10 gauge AWG @ Type TW, 60°C or equivalent, and (3) Circuit breakers or fusing...capable of 30 amp loading. Also, the installation must conform with this manual, local codes and electric utility rules. Failure to comply can result in DEATH, SERIOUS BODILY INJURY, OR PROPERTY DAMAGE.</p>

ELECTRIC WATER HEATER				ECO INSTALLED
IN CORRESPONDENCE RE- GARDING THIS HEATER AL- WAYS MENTION MODEL & SERIAL NO'S.			LISTED 1994	
MODEL NUMBER	CAPACITY	SERIAL NUMBER		
FACTORY EQUIPPED WITH				U.S. GAL.
UPPER ELEMENT	LOWER ELEMENT	MAXIMUM	VOLTS	CHECK (✓) HERE
				150
WATTS OPTIONAL WATTAGE UPPER ELEMENT	WATTS LOWER ELEMENT	WATTS MAXIMUM	A.C. ONLY CHECK (✓) HERE	IF INSTALLED AS FACTORY EQUIPPED
				P.S.I.
WATTS UPPER ELEMENT				WARNING SEE CONVERSION INSTRUCTION
WATTS	WATTS	WATTS	IF CONVERTED	
© Maytag is a Trademark of Maytag Corporation and is used under License to State Industries, Inc.				

NOTE: Whether or not the element conversion is made the model rating plate must be marked. Using a hard point ink pen, check the appropriate block within the model rating plate, which is located adjacent to the lower access panel.

Instructions for Installation (cont'd)

Water Piping

▲ WARNING

HOTTER WATER CAN SCALD: Water heaters are intended to produce hot water. Water heated to a temperature which will satisfy clothes washing, dish washing, and other sanitizing needs can scald and permanently injure you upon contact. Some people are more likely to be permanently injured by hot water than others. These include the elderly, children, the infirm, or physically/mentally handicapped. If anyone using hot water in your home fits into one of these groups or if there is a local code or state law requiring a certain temperature water at the hot water tap, then you must take special precautions. In addition to using the lowest possible temperature setting that satisfies your hot water needs, a means such as a mixing valve, should be used at the hot water taps used by these people or at the water heater. Mixing valves are available at plumbing supply or hardware stores. Follow manufacturers instructions for installation of the valves. Before changing the factory setting on the thermostat, read the "Temperature Regulation" section in this manual.

The illustration shows the attachment of the water piping to the water heater. The water heater is equipped with 3/4 inch water connections.

If a water heater is installed in a closed water supply system; such as one having a back-flow preventer, check valve, water meter with a check valve, etc. in the cold water supply; means shall be provided to control thermal expansion. Contact the local utility or call Maytag Customer Service at 1-800-788-8899 for an authorized servicer on how to control this situation.

NOTE: If using copper tubing, solder tubing to an adapter before attaching the adaptor to the cold water inlet connection. Do not solder the cold water supply line directly to the cold water inlet. It will harm the dip tube and damage the tank.

1. Look at the top cover of the water heater. The water outlet is marked hot. Connect the hot water pipe to the hot water outlet of the water heater.
2. Look at the top cover of the water heater. The cold water inlet is marked cold. Connect the cold water pipe to the cold water inlet of the water heater.

NOTE: Your water heater is super insulated to minimize heat loss from the tank. Further reduction in heat loss can be accomplished by insulating the hot water lines from the water heater.

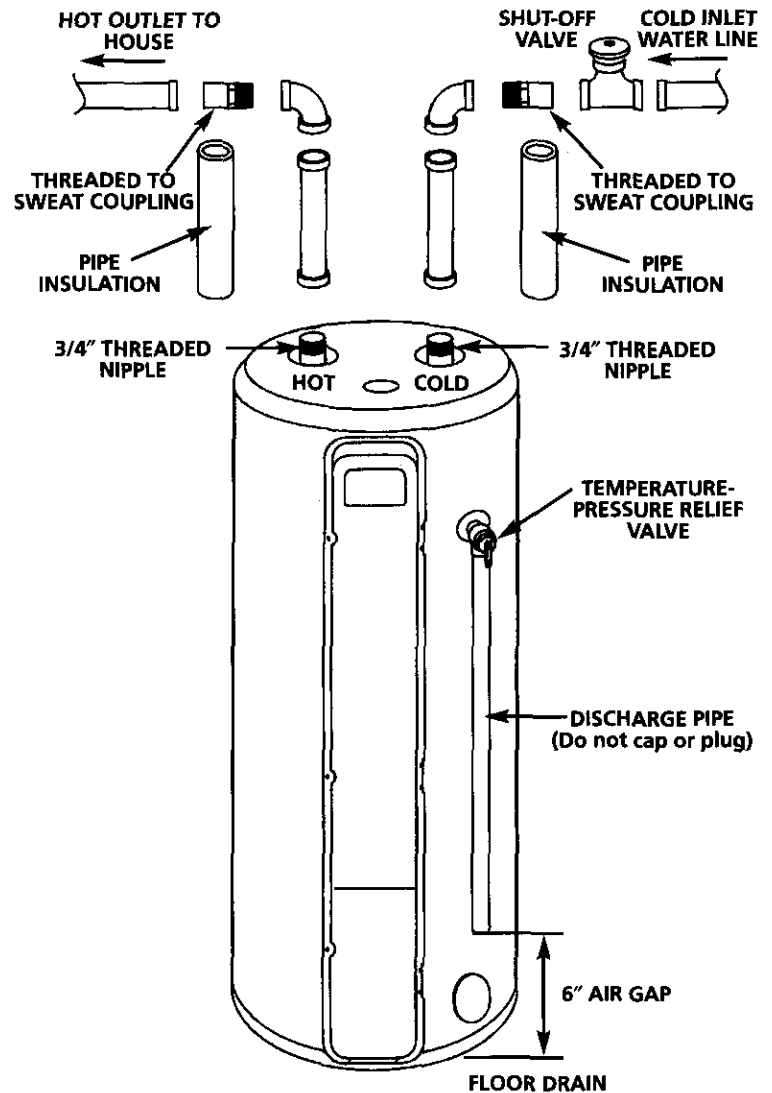

Instructions for Installation (cont'd)

Temperature-Pressure Relief Valve

▲ WARNING

At the time of manufacture this water heater was provided with a combination temperature-pressure relief valve certified by a nationally recognized testing laboratory that maintains periodic inspection of production of listed equipment or materials, as meeting the requirements for Relief Valves and Automatic Gas Shutoff Devices for Hot Water Supply Systems, and the latest edition of ANSI Z21.22 and the code requirements of ASME. If replaced, the valve must meet the requirements of local codes, but not less than a combination temperature and pressure relief valve certified as meeting the requirements for Relief Valves and Automatic Gas Shutoff Devices for Hot Water Supply Systems, ANSI Z21.22 by a nationally recognized testing laboratory that maintains periodic inspection of production of listed equipment or materials.

The valve must be marked with a maximum set pressure not to exceed the marked hydrostatic working pressure of the water heater (150 lbs./sq. in.) and a discharge capacity not less than the water heater input rate as shown on the model rating plate. (Electric heaters - watts divided by 1000 x 3415 equal BTU/Hr. rate.)

Your local jurisdictional authority, while mandating the use of a temperature-pressure relief valve complying with ANSI Z21.22 and ASME, may require a valve model different from the one furnished with the water heater.

Compliance with such local requirements must be satisfied by the installer or end user of the water heater with a locally prescribed temperature-pressure relief valve installed in the designated opening in the water heater in place of the factory furnished valve.

For safe operation of the water heater, the relief valve must not be removed from its designated opening or plugged.

The temperature-pressure relief valve must be installed directly into the fitting of the water heater designated for the relief valve. Position the valve downward and provide tubing so that any discharge will exit only within 6 inches above, or at any distance below the structural floor. Be certain that no contact is made with any live electrical part. The discharge opening must not be blocked or reduced in size under any circumstances. Excessive length, over 30 feet, or use of more than four elbows can cause restriction and reduce the discharge capacity of the valve.

No valve or other obstruction is to be placed between the relief valve and the tank. Do not connect tubing directly to discharge drain unless a 6" air gap is provided. To prevent bodily injury, hazard to life, or property damage, the relief valve must be allowed to discharge water in quantities should circumstances demand. If the discharge pipe is not connected to a drain or other suitable means, the water flow may cause property damage.

The Discharge Pipe:

- Must not be smaller in size than the outlet pipe size of the valve, or have any reducing couplings or other restrictions.
- Must not be plugged or blocked.
- Must be of material listed for hot water distribution.
- Must be installed so as to allow complete drainage of both the temperature-pressure relief valve, and the discharge pipe.
- Must terminate at an adequate drain.
- Must not have any valve between the relief valve and tank.

▲ WARNING

The temperature-pressure relief valve must be manually operated at least once a year. Caution should be taken to ensure that (1) no one is in front of or around the outlet of the temperature-pressure relief valve discharge line, and (2) the water manually discharged will not cause any bodily injury or property damage because the water may be extremely hot. If after manually operating the valve, it fails to completely reset and continues to release water, immediately close the cold water inlet to the water heater, follow the draining instructions, and replace the temperature-pressure relief valve with a new one.

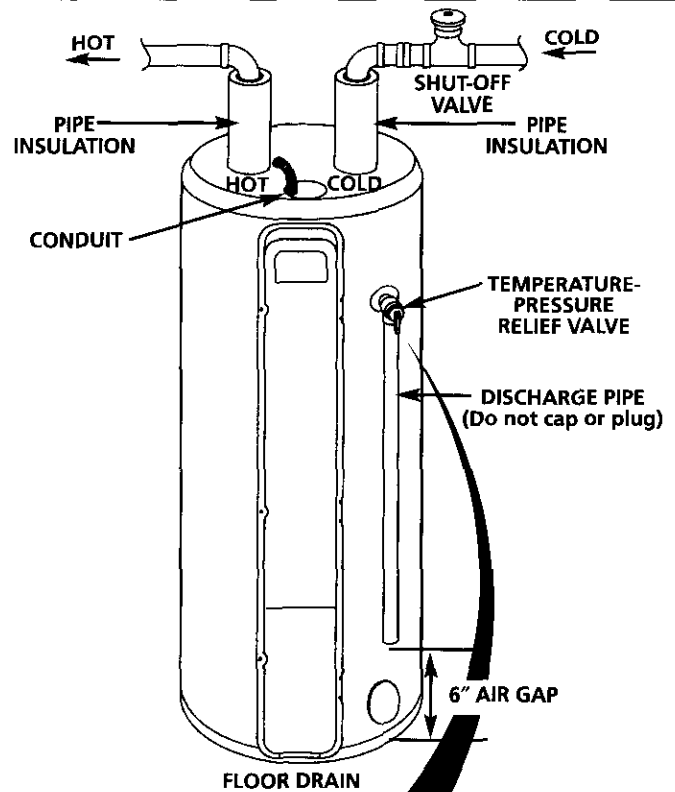

WARNING "RELIEF VALVE OPENING"

This water heater is provided with a combination Temperature-Pressure Relief Valve listed as complying with the standard for Relief Valves and Automatic Gas Shutoff Devices for Hot Water Supply Systems, ANSI Z21.22 and the code requirements of ASME.

Your local jurisdictional authority, while mandating the use of a Temperature-Pressure Relief Valve complying with ANSI Z21.22 and ASME, may require a valve model different from the one furnished with the water heater. Compliance with such local requirements must be satisfied by the installer or end user of the water heater with a locally prescribed Temperature-Pressure Relief Valve installed in the designated opening in the water heater.

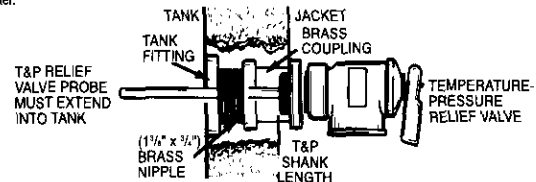

- If a short shank (less than 2") temperature-pressure relief valve is to be installed (as shown), a nipple and coupling must be used.
- If a long shank (2" or longer) is to be installed, do not use the nipple and coupling.

"Install Temperature-Pressure protective equipment required by local codes, but not less than a combination Temperature-Pressure Relief Valve certified as meeting the requirements for Relief Valves and Automatic Gas Shutoff Devices for Hot-Water Supply Systems, ANSI Z21.22 by a nationally recognized testing laboratory that maintains periodic inspection of production of listed equipment or materials. The valve must be oriented, provided with tubing, or otherwise installed so that discharge can exit only within 6 inches above, or at any distance below the structural floor, and cannot contact any live electrical part." For safe operation of the water heater, the Relief Valve must not be removed or plugged. See manual heading - "Temperature-Pressure Relief Valve" for installation and maintenance of Relief Valve, discharge pipe and other safety precautions.

Instructions for Installation (cont'd)

Filling the Water Heater

To fill the water heater with water:

1. Close the water heater drain valve by turning the handle to the right (clockwise). The drain valve is on the lower front of the water heater.
2. Open the cold water supply valve to the water heater.
NOTE: The cold water supply valve must be left open when the water heater is in use.
3. To insure complete filling of the tank, allow air to exit by opening the nearest hot water faucet. Allow water to run until a constant flow is obtained. This will let air out of the water heater and the piping.

▲ CAUTION
Never use this water heater unless it is completely full of water. To prevent damage to the tank and heating element, the tank must be filled with water. Water must flow from the hot water faucet before turning "ON" power.

4. Check all new water piping for leaks. Repair as needed.

Converting the Lower Element

These instructions only cover the conversion of the convertible element, read this entire manual before attempting to install or operate the water heater. The water heater is factory set to operate at 3800 watts. The lower element can be converted to operate at 5500 watts. Refer to "The Convertible Lower Element" section.

The **Upper Element** is a conventional 3800 watt element which only operates at its rated wattage on 240 volts. (See rating plate on water heater).

The **Lower Element** of the water heater can be converted from operation at 3800 watts to 5500 watts on a 240 volt system.

If after reading these instructions and this manual, if you do not understand any portion, call Maytag Customer Service at 1-800-788-8899 for an authorized servicer.

▲ WARNING
Before making the conversion to 5500 watts, check the (1) power supply...must be 240 volts, (2) wiring...10 gauge AWG @ Type TW, 60°C or equivalent, and (3) Circuit breakers or fusing...capable of 30 amp loading. Also, the installation must conform with this manual, local codes and electric utility rules. Failure to comply can result in DEATH, SERIOUS BODILY INJURY, OR PROPERTY DAMAGE.

ELECTRIC WATER HEATER				ECO INSTALLED
IN CORRESPONDENCE RE- GARDING THIS HEATER AL- WAYS MENTION MODEL & SERIAL NO'S.		UL	LISTED 150V	
MODEL NUMBER	CAPACITY	SERIAL NUMBER		
FACTORY EQUIPPED WITH				U.S. GAL.
UPPER ELEMENT	LOWER ELEMENT	MAXIMUM	VOLTS	CHECK (✓) HERE
				150
WATTS				MAXIMUM HYDROSTATIC WORKING PRESSURE
OPTIONAL WATTAGE	UPPER ELEMENT	LOWER ELEMENT	MAXIMUM	A.C. ONLY CHECK (✓) HERE
WATTS				IF INSTALLED AS FACTORY EQUIPPED
				P.S.I.
				WARNING SEE CONVERSION INSTRUCTION
WATTS				IF CONVERTED
© Maytag is a Trademark of Maytag Corporation and is used under License to State Industries, Inc.				

NOTE: Whether or not the element conversion is made the model rating plate must be marked. Using a hard point ink pen, check the appropriate block within the model rating plate, which is located adjacent to the lower access panel.

Necessary element conversion parts are located in a small bag contained within the large plastic manual envelope attached to the side of the water heater.

CONVERSION PARTS

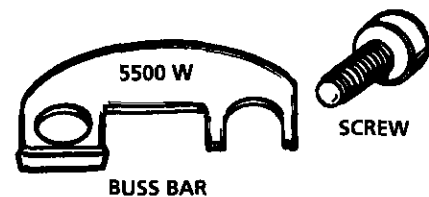

Instructions for Installation (cont'd)

Converting the Lower Element (cont'd)

1. Before beginning the conversion turn "OFF" electric power supply to the water heater.

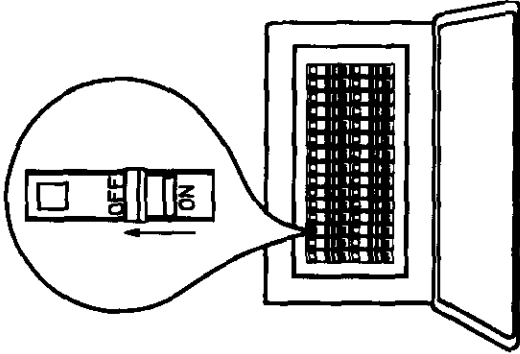

▲ WARNING

HAZARD OF ELECTRICAL SHOCK! Before removing any access panels or servicing the water heater, make sure the electrical supply to the water heater is turned "OFF". FAILURE TO DO THIS COULD RESULT IN DEATH, SERIOUS BODILY INJURY, OR PROPERTY DAMAGE.

2. The convertible element is located behind the lower access panel of the water heater. Remove the screw securing the access panel, and remove panel.

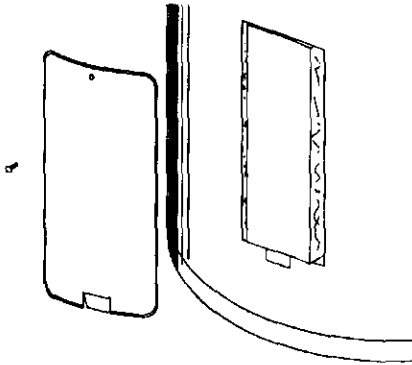

3. Remove the flap of insulation to expose the opening.

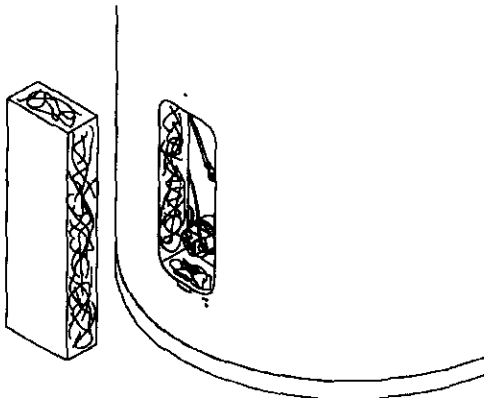

4. Remove the screws from terminal 2 of the element, and move the looped end of the wire aside.

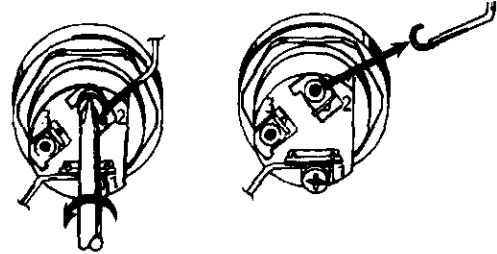

5. The buss bar is labeled 5500 W. Place the buss bar over terminals 2 and 3 with the 5500 W visible. Install the extra screw provided into terminal 3.

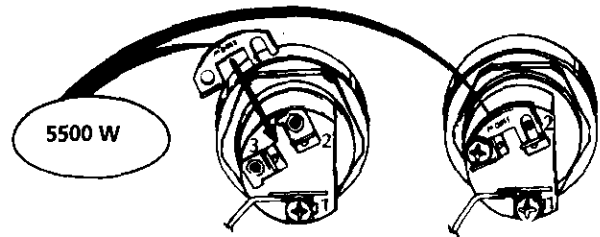

6. The wire removed from terminal 2 has a looped end. It must remain looped and now be placed (as shown) on top of the buss bar, over the opening of terminal 2, and secured using the remaining screw.



7. Tighten terminals 2 and 3 to ensure proper electrical connection.

▲ WARNING

Failure to tighten terminal screws can cause a fire which can result in DEATH, SERIOUS BODILY INJURY, OR PROPERTY DAMAGE.

Instructions for Installation (cont'd)

Converting the Lower Element (cont'd)

8. Press the insulation back in place so that it completely covers the thermister and element.

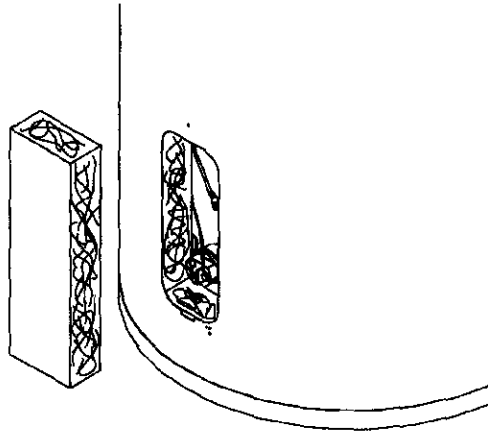

9. Replace the access panel.

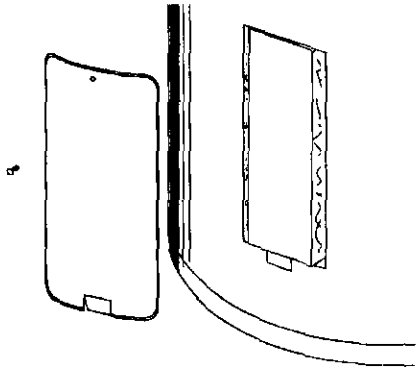

10. Complete wiring to the water heater, or if completed, turn "ON" electric power to the water heater after filling the tank with water.

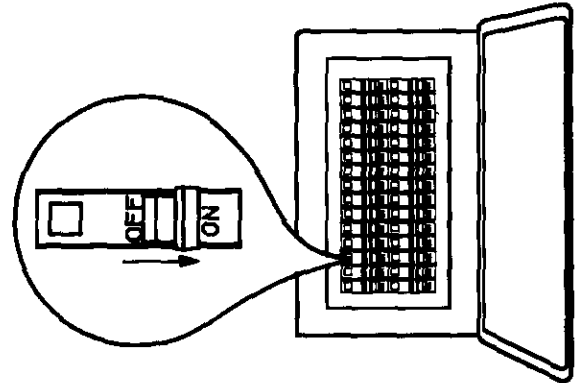

▲ CAUTION

Never use this water heater unless it is completely full of water. To prevent damage to the tank and heating element, the tank must be filled with water. Water must flow from the hot water faucet before turning "ON" power.

Instructions for Installation (cont'd)

Wiring Diagram

STANDARD WIRING FOR
2 WIRE LEAD WATER HEATERS
NON-SIMULTANEOUS OPERATION
240 VOLT DOUBLE ELEMENT

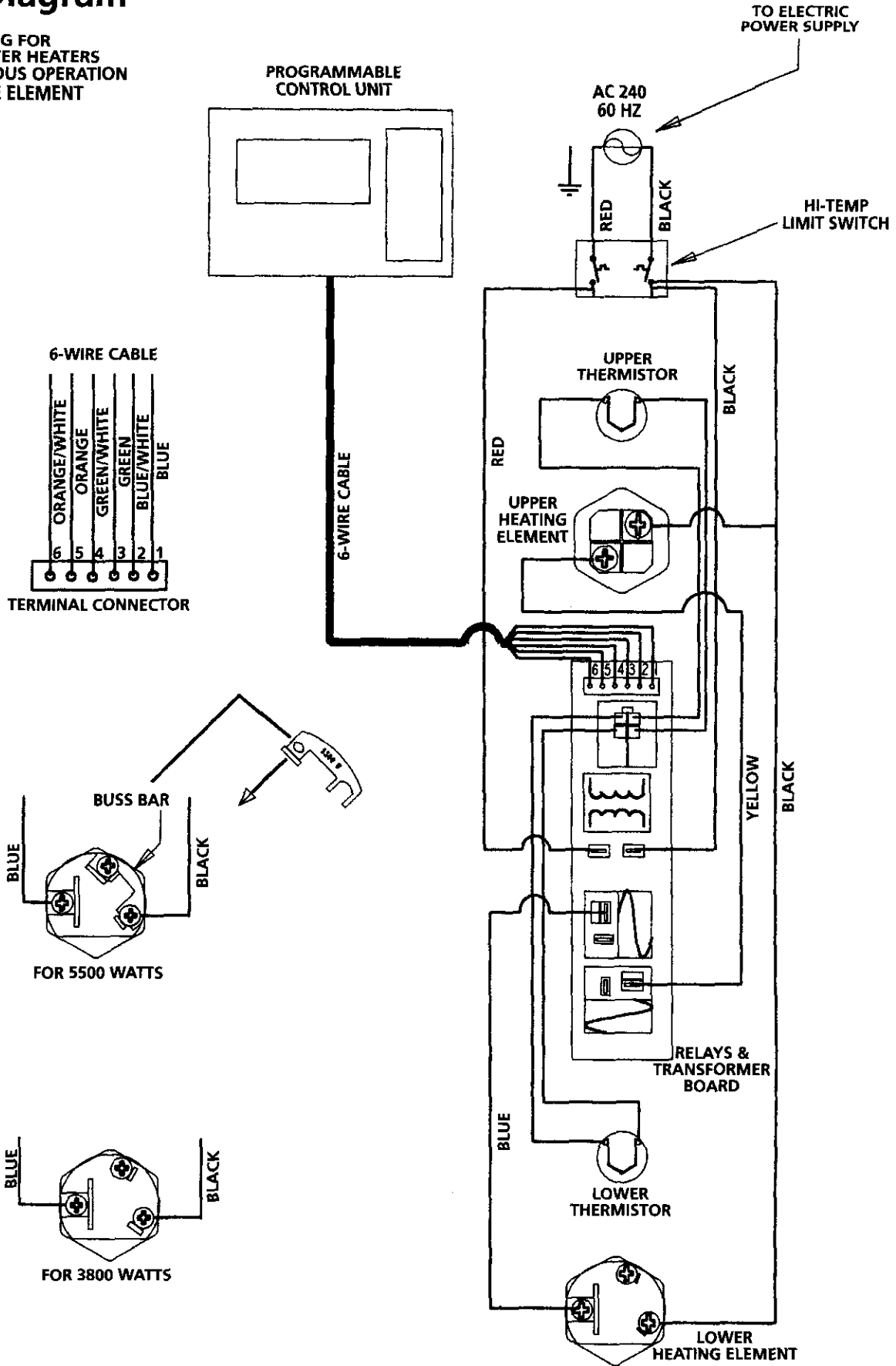

Instructions for Installation (cont'd)

Wiring

▲ CAUTION

Never use this water heater unless it is completely full of water. To prevent damage to the tank and heating element, the tank must be filled with water. Water must flow from the hot water faucet before turning on power.

You must provide all wiring of the proper size outside of the water heater. You must obey local codes and electric company requirements when you install this wiring.

If you are not familiar with electric codes and practices, or if you have any doubt, even the slightest doubt, in your ability to connect the wiring to this water heater, obtain the service of a competent electrician. Call Maytag Customer Service at 1-800-788-8899 for an authorized servicer.

▲ WARNING

WATER HEATERS EQUIPPED FOR ONE VOLTAGE ONLY: This water heater is equipped for one type voltage only. Check the rating plate near the bottom access panel for the correct voltage. DO NOT use this water heater with any voltage other than the one shown on the model rating plate. Failure to use the correct voltage can cause problems which can result in DEATH, SERIOUS BODILY INJURY, OR PROPERTY DAMAGE. If you have any questions or doubts consult your electric company.

▲ CAUTION

If wiring from your fuse box or circuit breaker box was aluminum for your old water heater, replace it with copper wire. If you wish to reuse the existing aluminum wire, have the connection at the water heater made by a competent electrician. Call Maytag Customer Service at 1-800-788-8899 for an authorized servicer.

1. Provide a way to easily shut off the electric power when working on the water heater. This could be with a circuit breaker or fuse block in the entrance box or a separate disconnect switch.
2. Install and connect a circuit directly from the main fuse or circuit breaker box. This circuit must be the right size and have its own fuse or circuit breaker. Refer to the chart in the "Product Specifications" section for the correct size wire and fuse or circuit breaker.
3. If metal conduit is used for the grounding conductor:
 - A. The grounding electrode conductor shall be of copper, aluminum, or copperclad aluminum. The material shall be of one continuous length without a splice or joint.
 - B. Rigid metal conduit, intermediate metal conduit, or electrical metallic tubing may be used for the grounding means if conduit or tubing is terminated in fittings approved for grounding.

- C. Flexible metal conduit or 3 metallic tubing shall be permitted for grounding if all the following conditions are met:
 1. The length in any ground return path does not exceed 6 feet.
 2. The circuit conductors contained therein are protected by overcurrent devices rated at 20 amperes or less.
 3. The conduit or tubing is terminated in fittings approved for grounding.

For complete grounding details and all allowable exceptions, refer to the latest edition of the National Electrical Code.

4. A standard 1/2" conduit opening has been made in the water heater junction box for the conduit connection.
5. A wiring diagram (See "Wiring Diagram" Section) has been supplied showing the connections between the water heater and the power supply. You can easily see the connection by removing the junction box cover on top of the water heater. Connect red to red, black to black, and the ground wire to the green ground screw in the junction box of the water heater.
6. Use wire nuts and connect the power supply wiring to the wires inside the water heater's junction box.
7. The water heater must be electrically "grounded" by the installer. A green ground screw has been provided on the water heater's junction box. Connect ground wire to this location.
8. Replace the wiring junction cover using the screw provided.

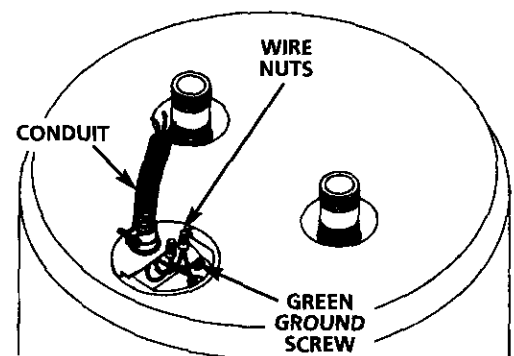

Instructions for Installation (cont'd)

Selecting Thermostat Location

1. The programmable thermostat control module is shipped attached to the front of the water heater, located behind the hinged cover panel.

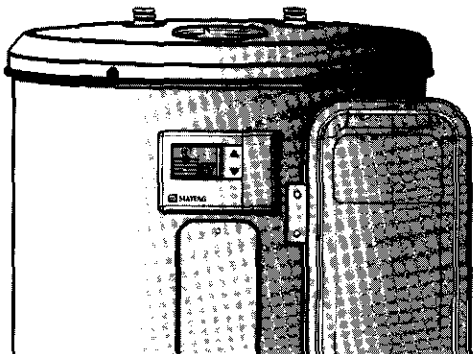

If this thermostat location is acceptable to the homeowner, proceed directly to the "Installation Checklist" on page 22 and then to "Temperature Regulation" on page 23.

2. The thermostat control module can also be installed next to the home's heating or heating/cooling thermostat, or in another convenient location remote from the water heater.

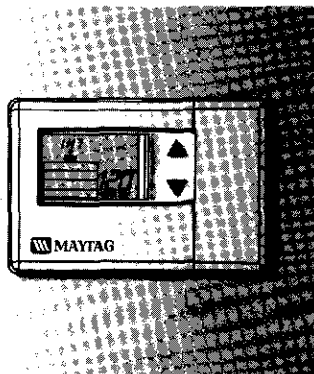
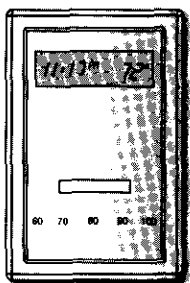

3. The remote location should be about 5 feet above the floor on any wall with good air circulation at average room temperature.

ROUTING WIRE HARNESS TO LOCATION

4. A wiring harness kit for up to 50 feet of wiring is available (see Repair Parts list) from your Maytag Dealer.
5. Before drilling a hole in the wall at the selected location, take up floor moulding (quarter round or other) and drill a small guide hole for sighting. From the basement, drill a 3/4" hole in partition floor next to guide hole (in homes with no basement, drill a 1/2" hole through ceiling above the partition).

6. Probe for any obstruction in the partition. In a clear area drill a 1/2" hole through the wall at the selected location.
7. Through this hole in the wall, drop a light chain or short chain attached to a strong cord. Snag the cord with a hooked wire from the basement. (In a home with no basement, drop the cord from ceiling and snag it at the thermostat hole location.)
8. Attach one end of the wiring harness to the cord. Pull the cable through the hole in the wall so that 6 inches of cable protrudes. Other end of cable is to be routed back to the junction box on top of the water heater (Step 21). Before proceeding, turn "OFF" the electric power supply to the water heater.

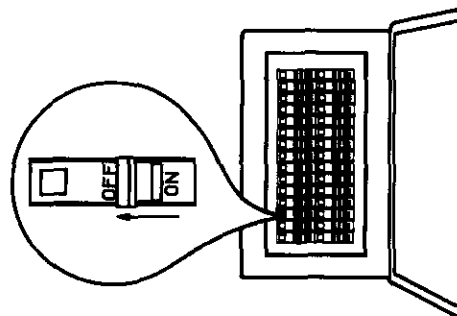

▲ WARNING

HAZARD OF ELECTRICAL SHOCK! Before removing any access panels or servicing the water heater, make sure the electrical supply to the water heater is turned "OFF". Failure to do this could result in DEATH, SERIOUS BODILY INJURY, OR PROPERTY DAMAGE.

THERMOSTAT REMOVAL

9. Holding fingers along the top and thumb on bottom, between the thermostat and wall plate, gently remove thermostat from the wall plate. The thermostat will be installed at the selected remote location in Steps 32 and 33.

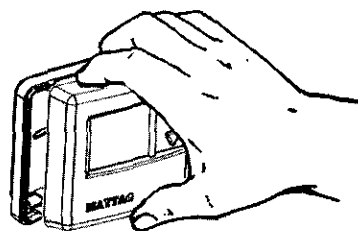

Instructions for Installation (cont'd)

THERMOSTAT REMOVAL (cont'd)

10. Carefully disconnect wiring harness terminal connector from back of thermostat.

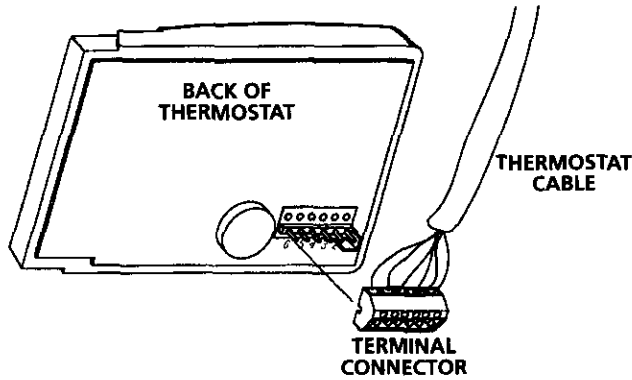

11. Remove the wall plate from the water heater by unscrewing the two mounting screws. The wall plate will be installed at the selected location in Steps 28 and 29.

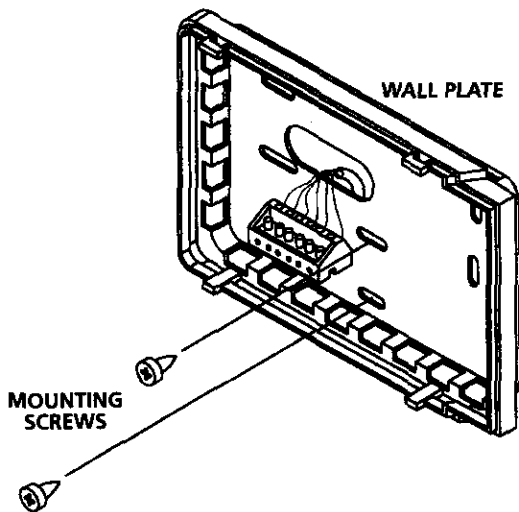

12. Loosen each screw in the terminal connector and remove the wire ends. The terminal connector will be installed at the selected remote location in Step 31.

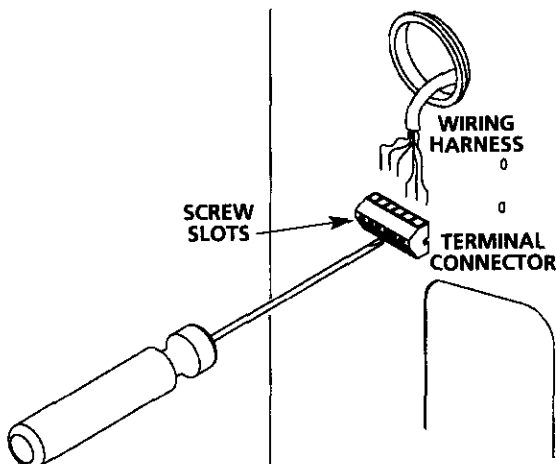

13. Press the end of the thermostat cable back into the insulating bushing. No other connections will be made to this end of the cable.

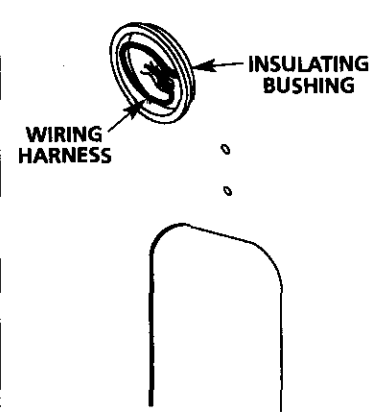

14. Close and latch outer door.

REMOTE THERMOSTAT WIRING AT WATER HEATER

15. Remove mounting screw and right junction box cover. Also lift up and remove black plug on left junction box cover. Discard plug.

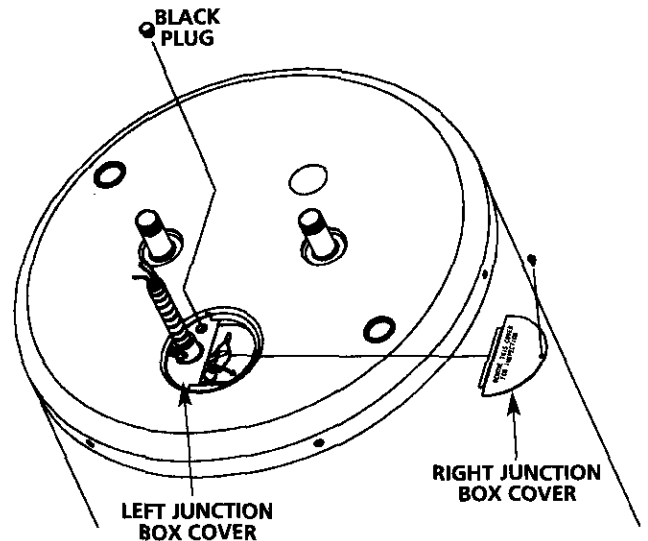

Instructions for Installation (cont'd)

16. Find the loop of thermostat wiring cable (grey colored) inside the junction box and pull it out.

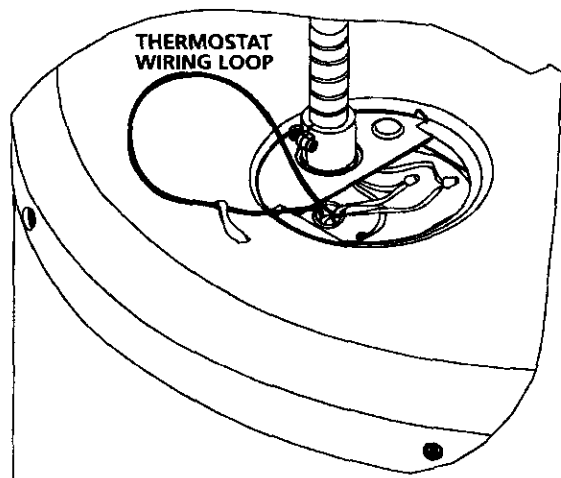

17. Cut the thermostat wiring cable in half at the top of the loop.

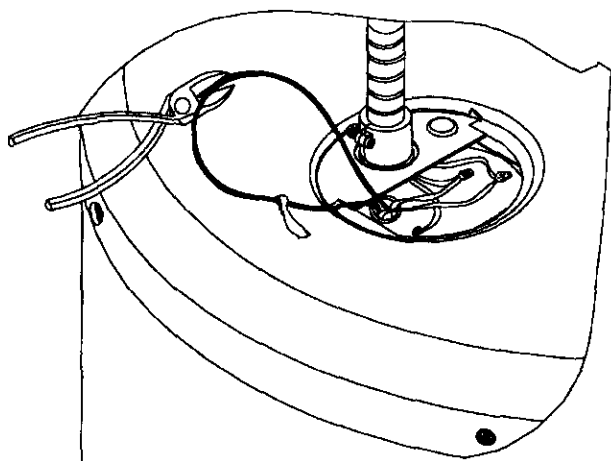

18. The wire side of the loop which does not have the red tape strip on it should be cut off or pressed into the junction box out of the way.

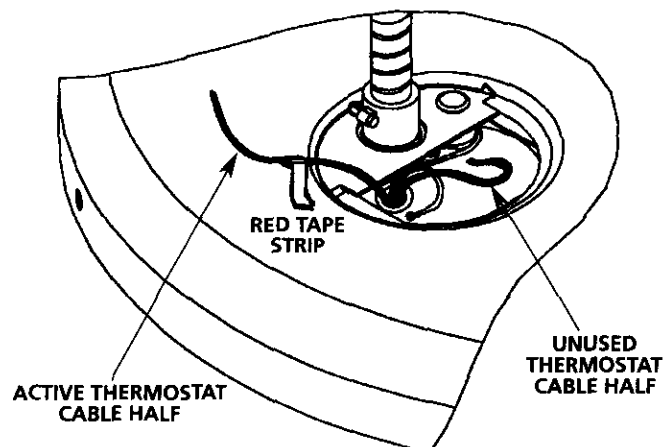

19. Strip the thermostat cable outer insulation back 1 1/4 inches. Strip the ends 1/4 inch on each of the six colored wires.

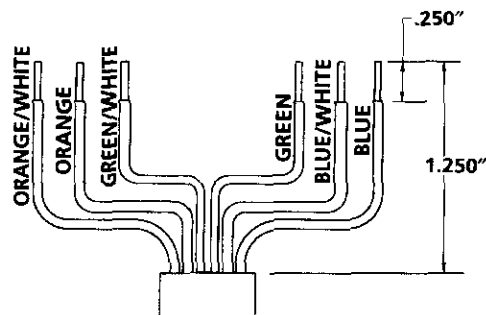

20. A second terminal connector is provided in a small bag contained within the large plastic manual envelope attached to the side of the water heater. Loosen each screw in the terminal connector. Insert the six colored wires of the thermostat cable into the terminal connector and tighten each screw to secure each wire. **Be sure to arrange wires in exact color sequence as shown.**

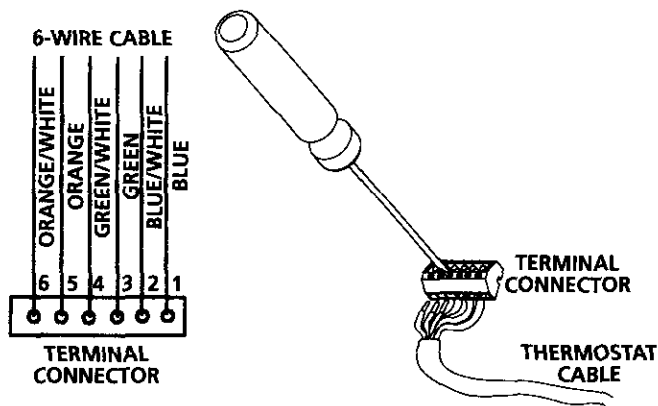

▲ CAUTION

The six colored insulated wires must be installed in the terminal connector exactly as shown for the thermostat to operate correctly.

21. Locate the end of the remote thermostat cable routed to the water heater in Step 8.

Instructions for Installation (cont'd)

Selecting Thermostat Location (cont'd)

22. Guide the end of the remote thermostat cable through the hole where the black plug was removed in the left junction box cover.

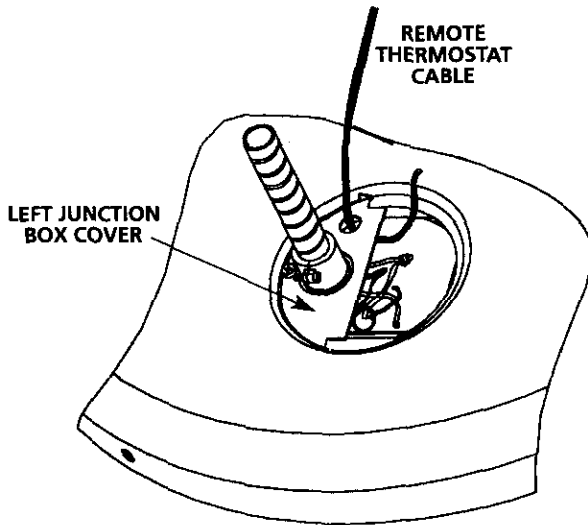

23. Strip the end of the remote thermostat cable outer insulation back 1 1/4 inches. Strip the ends 1/4 inch on each of the six colored wires.

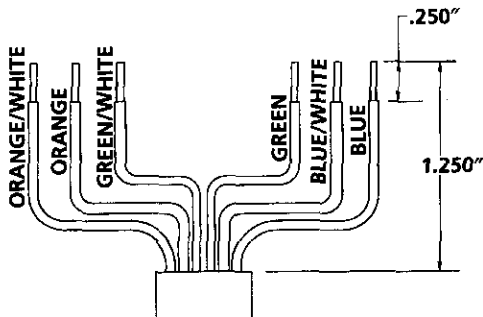

24. Loosen each screw in the terminal connector one at a time and insert wire with the **same color insulation into each numbered slot**. Tighten each screw securely making sure both wires in each slot are tight.

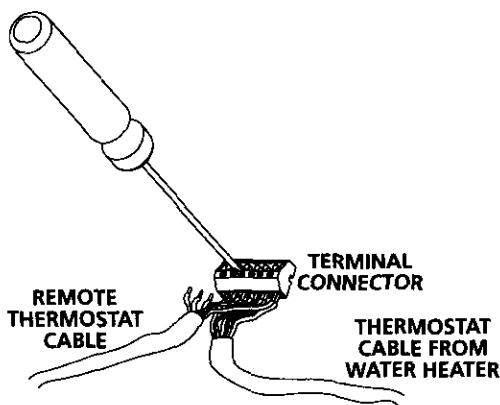

25. Carefully press the terminal connector and connected wires down into the water heater junction box.

26. A strain-relief bushing is also provided in the small bag that contained the terminal connector. Open the bushing and place it around the remote thermostat cable exiting the junction box. Press the bushing into the hole in the left junction box cover.

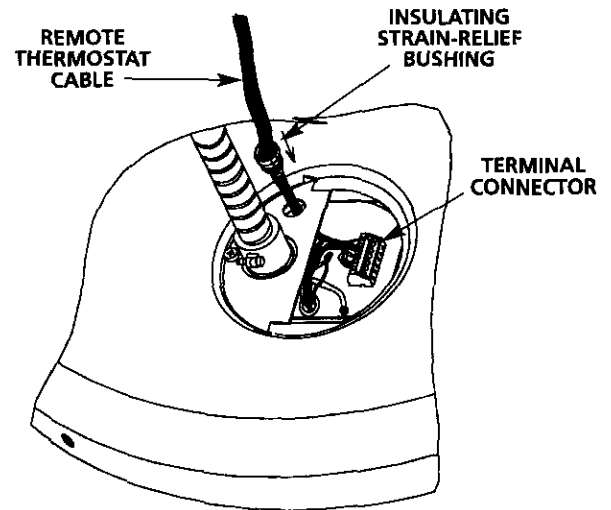

27. Replace the right junction box cover using the screw provided. This completes the remote thermostat wiring at the water heater.

REMOTE THERMOSTAT INSTALLATION AND WIRING

28. Locate the 6 inches of remote thermostat cable protruding through the wall opening (from Step 8). Using the wall plate removed in Step 11, pull the cable through opening near center of wall plate.

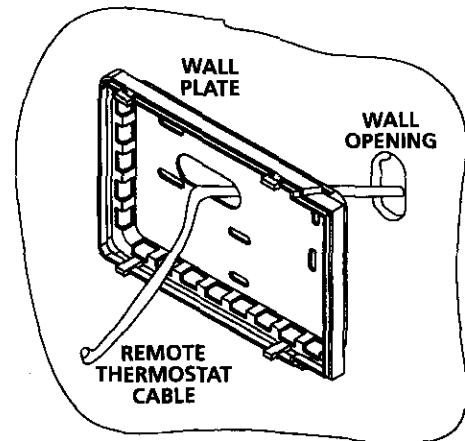

Instructions for Installation (cont'd)

29. Fasten wall plate loosely to the wall in position shown using the three screws provided in the plastic bag. Wall anchors are recommended for drywall installation. Place a level on top of the wall plate, adjust until level, and then tighten screws to secure wall plate.

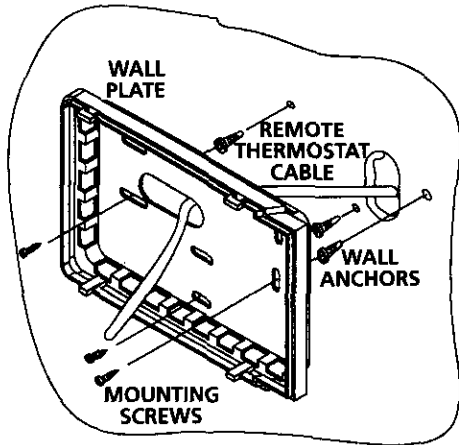

30. Strip the remote thermostat cable outer insulation back 1/4 inches. Strip the ends 1/4 inch on each of the six colored wires.

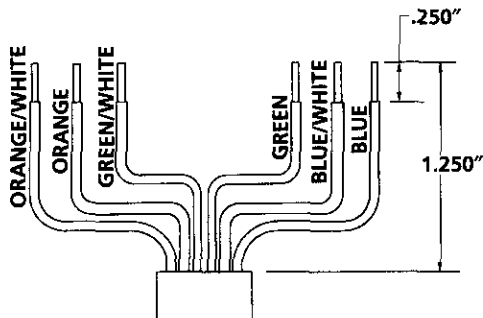

31. Using the terminal connector removed in Step 12, insert the six colored insulated wires in the remote thermostat cable into the numbered slots in the terminal connector and tighten each screw to secure each wire. **Be sure to arrange wires in exact color sequence as shown.**

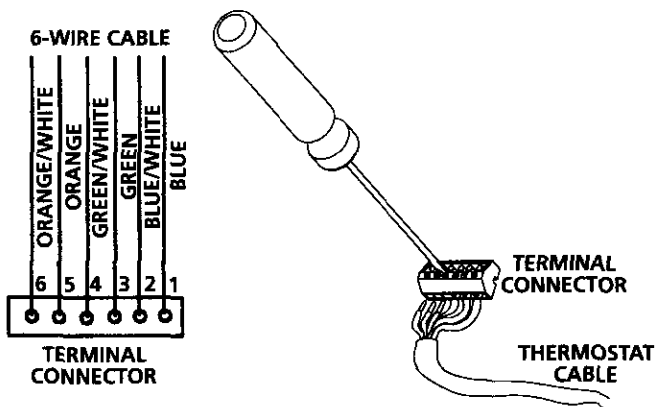

▲ CAUTION

The six colored insulated wires must be installed in the terminal connector exactly as shown for the thermostat to operate correctly.

32. Carefully plug the wired terminal connector to the mating pins on the thermostat back. Connector will install in one direction only as shown.

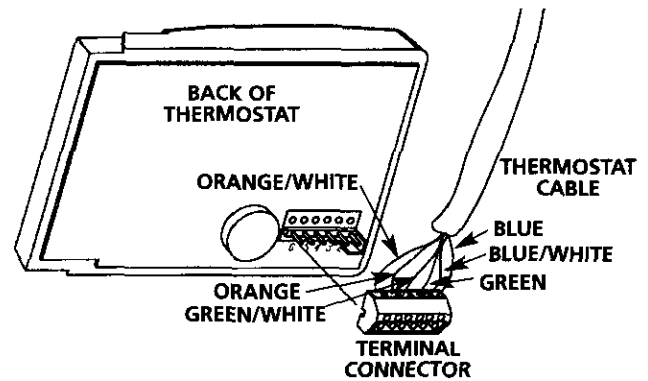

33. Place thermostat over wall plate, press firmly, and thermostat will snap into place on the wall plate.

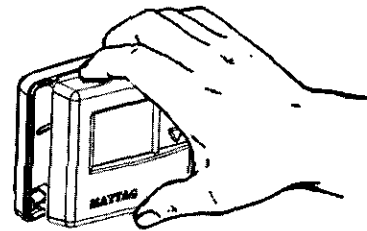

34. Turn "ON" electric power to water heater.

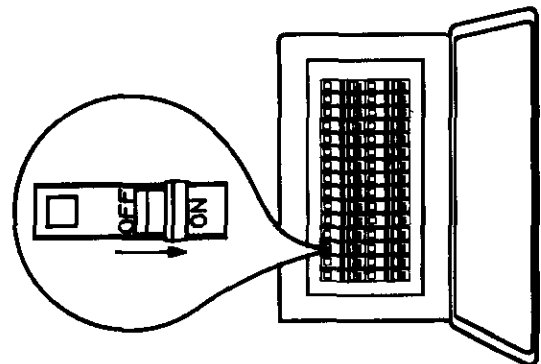

35. Read Temperature Regulation Warning and Temperature Settings, then proceed to Programming the Thermostat.

Instructions for Installation (cont'd)

Installation Checklist

1. Whether or not the element conversion is made, the model rating plate must be marked. Using a hard point ink pen, check the appropriate block within the model rating plate, which is located adjacent to the lower access panel.
2. Is the fuse or circuit breaker size correct as shown in the chart in the "Product Specifications" section?
3. Are the wires from the circuit breaker or fuse service to the water heater's junction box on the correct wire size (gauge) as shown in the chart in the "Product Specifications" section?
4. Is the new temperature-pressure relief valve properly installed, and piped to an adequate drain? See "Temperature-Pressure Relief Valve" in the "Instructions for Installation" section.
5. Is the water heater completely filled with water? See "Filling the Water Heater" instructions in the "Instructions for Installation" section.
6. Will a water leak damage anything? See "Locating the New Water Heater" in the "Instructions for Installation" section.
7. Are the cold and hot water lines connected to the water heater correctly? See "Water Piping" instructions in the "Instructions for Installation" section.
8. Is there adequate clearance for maintenance around the water heater?
9. If the programmable thermostat has been moved to a remote location, has the wiring been done correctly?
10. Do you need to call your electric company to check your wiring?

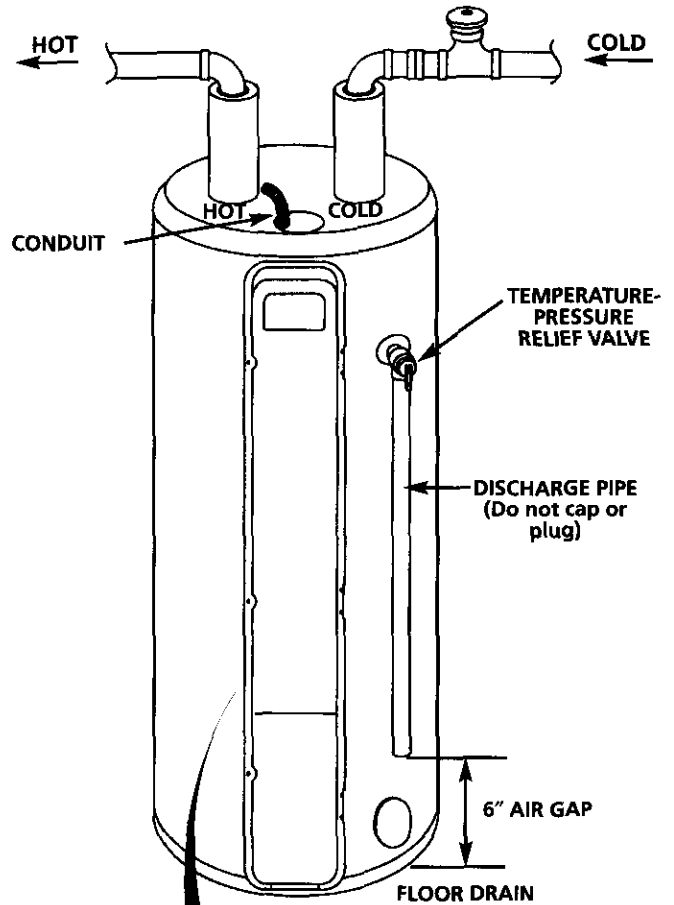

ELECTRIC WATER HEATER						ECO INSTALLED
IN CORRESPONDENCE REGARDING THE HEATER ALWAYS MENTION MODEL & SERIAL NO'S.		RE-CHARTING THE HEATER ALWAYS MENTION MODEL & SERIAL NO'S.		LISTED 100W	SERIAL NUMBER	
MODEL NUMBER				CAPACITY	SERIAL NUMBER	
FACTORY EQUIPPED WITH					U.S. GAL.	
UPPER ELEMENT	LOWER ELEMENT	MAXIMUM	VOLTS	CHECK (✓) HERE	MAXIMUM HYDROSTATIC WORKING PRESSURE	
					150	
WATTS		WATTS	WATTS	A.C. ONLY	IF INSTALLED AS FACTORY EQUIPPED	
OPTIONAL WATTAGE		UPPER ELEMENT	LOWER ELEMENT	MAXIMUM	CHECK (✓) HERE	
WATTS	WATTS	WATTS	WATTS	IF CONVERTED	WARNING SEE CONVERSION INSTRUCTION	

MODEL RATING PLATE

Instructions for Operation

Temperature Regulation

▲ WARNING

HOTTER WATER CAN SCALD: Water heaters are intended to produce hot water. Water heated to a temperature which will satisfy clothes washing, dish washing, and other sanitizing needs can scald and permanently injure you upon contact. Some people are more likely to be permanently injured by hot water than others. These include the elderly, children, the infirm, or physically/mentally handicapped. If anyone using hot water in your home fits into one of these groups or if there is a local code or state law requiring a certain temperature water at the hot water tap, then you must take special precautions. In addition to using the lowest possible temperature setting that satisfies your hot water needs, a means such as a mixing valve, should be used at the hot water taps used by these people or at the water heater. Mixing valves are available at plumbing supply or hardware stores. Follow manufacturers instructions for installation of the valves.

▲ WARNING

Never allow small children to use a hot water tap, or to draw their own bath water. Never leave a child or handicapped person unattended in a bathtub or shower.

Temperature Conditions

VERY LOW – The thermostat minimum setback temperature is 60°F.

HOT– A thermostat setting of 120°F will supply hot water at the most economical temperatures.

VERY HOT– The thermostat maximum temperature is 160°F. It is recommended that the temperature be set lower whenever possible.

NOTE: Water temperature range of 120°–140°F recommended by most dishwasher manufacturers.

Programming the Thermostat

Before programming the settings on the thermostat, read the “Temperature Regulation” section again.

This new programmable thermostat technology makes it possible for you to enjoy all the benefits of hot water whenever you need it and save the cost of heating water when you don't need it.

Simple and easy to use, the programmable control has three basic modes of operation:

1. **Manual** mode – a set and forget operation.
2. **Vacation** mode – for those occasions when the residence is unoccupied and there is no need for hot water.
3. **Programmable** mode – can be programmed for up to 24 hour a day, 7 days a week with 4 set periods a day.

Override is an optional setting that allows for temperature adjustments during a given time period. This setting reverts back to the previous mode of operation upon completion of the designated override time period.

Option menu is a mode to change the factory setting for the time clock (12 hr. clock or 24 hr. military), temperature scale (°F to °C), default heating setpoint, vacation setpoint and maximum heating setpoint.

DATE AND TIME SETTING:

Your new programmable control comes complete with a day of the week and digital clock display. These settings are changed using the day and time keys on the control pad. To adjust day and/or time, depress the appropriate key button. The day of the week scrolls left to right on the display as the “DAY” button is depressed. The time setting can be adjusted by scrolling forward or backward using the + and - of the “TIME” button. The clock is based on a 24-hour rolling display with AM and PM appearing below the hour and minute characters.

CONSTANT TEMPERATURE DISPLAY:

The constant display screen shows the water temperature “**WATER TEMP**” inside the tank. It is continually on display until interrupted by a reprogram procedure, but reappears after 20 seconds of inactivity.

MODE CHANGE

To change the mode-of-operation depress the “MODE” button at the bottom of the control. The mode display will change by scrolling from top to bottom with the Auto mode appearing on the top of the column, followed by the Manual mode in the middle and finally the Vacation mode at the bottom. Continue to change between mode settings by depressing the “MODE” button until the desired setting is displayed.

Instructions for Operation (cont'd)

Programming the Thermostat (cont'd)

Normal Display

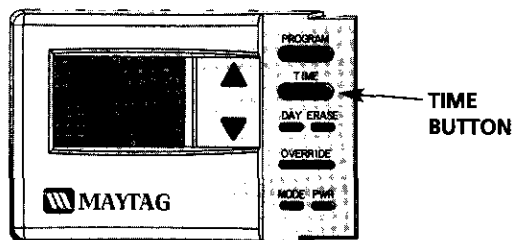

Program Display

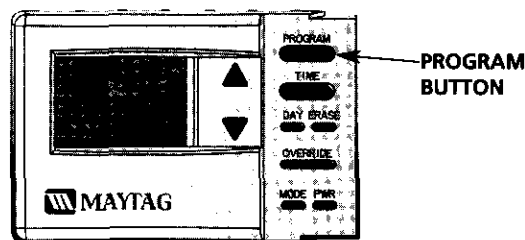

MANUAL MODE

The most basic operation of the Intelligent water heater thermostat is the **Manual Mode**. With this mode the thermostat is set at a desired temperature and the water heater operates to maintain that temperature. The Intelligent Maytag water heater utilizes a special sensing device in the control system that allows for temperature accuracy to be maintained at plus or minus 1°F.

VACATION MODE

Vacation mode is used whenever the residency is unoccupied for a considerable length of time (2-days or longer) and hot water is not needed. By selecting the **Vacation Mode** the water heater will maintain a reduced setting of 80 degrees until a new operation mode is selected.

PROGRAMMABLE MODE

The **Auto mode** selection permits the water heater to be programmed for four periods a day, 24-hours a day and 7-days a week. To begin programming, depress the "MODE" button until the AUTO selection appears in the display. To activate the Program Mode depress the "PROGRAM" button at the top of panel. The programming mode should appear as the next display.

The first period to program is Monday "Morn" - this period is designated as "**Morn**". By depressing the + or - of the "**TIME**" button, the owner can choose the target time for the water to be at a specific temperature. The heating elements will be activated 15 minutes before the target time to heat the water to the desired temperature. For example, if 6:00 AM is the time the occupant desires 130°F water for bathing, the time on the programmed display would be set for 6:00 AM. The next selection to program is the desired water temperature to have for morning activities. In this example the temperature would be set to 130°F by depressing either the up (▲) arrow or the down (▼) arrow, located next to the display panel, until the target temperature is displayed.

The second period to program is Monday "Day" - the method of setting the time and temperature are the same for all four selected periods of the day. The second period designated "**Day**" can be set to a reduced temperature (70°F or lower) due to the lack of need for hot water, assuming no one is at home during the day. If everyone leaves at 9:30 AM, this time can be entered into the program and the heating elements would not activate until the temperature in the tank dropped to 70°F.

The third period to program is Monday "Eve" - this period is designated "**Eve**" would usually begin when people arrive home from their daily activities. The temperature for this period can be adjusted to a normal hot water setting considering evening demand like washing dishes or clothes. For example if 125°F is the chosen temperature to have at 5:30 PM then these settings would be entered into the program.

The fourth period to program is Monday "Nite" - this period is designated "**Nite**" and is usually the beginning of decreased hot water needs as the residents retire for the night. In the example the temperature would be set for 70°F or lower with the begin time set at 11:00 PM.

Program Copy - The first day of programming has now been completed. If each succeeding day of the workweek requires the same desired settings as those just programmed for Monday, these settings can be copied to the remaining four days of the week by depressing and holding the "**PROGRAM**" button for several seconds. In this manner the first day's settings are repeated to all four remaining weekdays.

Weekend programming - the weekend programming can be set different than the weekday settings, if desired. Saturday and Sunday can be separately programmed by advancing the program selection to the day marked "**SA**" and/or "**SU**". The steps described above for programming the four periods per day can be repeated for the weekend only using different times and temperatures to provide desired water temperatures when needed on the weekend.

Instructions for Operation (cont'd)

ERASE is the option that can delete all the settings that had been programmed previously. While in the programmable mode, depressing the “ERASE” button will delete a particular time period that is on display. Depressing and holding the “ERASE” button down for several seconds will erase all the settings for an entire week. This procedure should be administered carefully, as erasing the entire week's programmed settings will necessitate a complete reprogramming procedure.

OVERRIDE is an option that can be used to temporarily adjust water temperature for a specific length of time. If for example there is a need for higher water temperatures during a specific number of hours or days, the “OVERRIDE” button can be depressed. The first screen to be displayed is the **HOURS** and **DAYS** time menu and **DESIRED TEMPERATURE**. The default time period is 3 hours. This time can be adjusted upward or downward by using the + or - of the “TIME” button. After holding the + “TIME” button beyond 24 hours the hours and days designation will appear. The **OVERRIDE** can be adjusted for both days as well as hours. The maximum number of days to **OVERRIDE** is 99.

Override Display

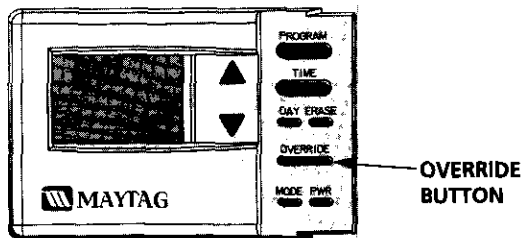

After setting the time duration, the override temperature can be adjusted by using the up (▲) arrow or the down (▼) arrow, located next to the display panel, until the target temperature is displayed. For example, if guests arrive for the weekend and warmer water temperatures are desired, the occupant may adjust the temperature setting to 130°F for 2 days and 10 hours. This would control the target temperature until the completion of the designated time and return the thermostat to the program control that had been in operation before the override was implemented.

OPTIONAL SETTING CHANGES

There are five optional settings the owner can change in the programmable control module. To advance to the Optional Setting Mode, depress the “PROGRAM” and “MODE” buttons simultaneously for four seconds. Four zeros should appear in the upper left hand corner (0000) and a large number 1 should appear in the bottom right-hand corner. This indicates the optional menu is on the type of time setting.

The first optional mode (1) setting involves the type of time that will appear on the clock display. The default setting is the normal twelve-hour clock. For military time depress either + or - of the “TIME” button until the description 0001 appears in the upper-left hand corner. To change back to normal time in optional setting 1 depress either (+ or -) of the time buttons until 0000 appears in the upper left-hand corner.

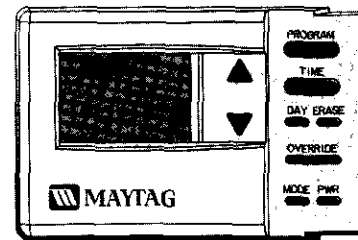

The second optional mode (2) setting involves the temperature scale. To change to the temperature setting option, depress the up or down arrow button until the large number 2 appears in the lower right hand corner. The default setting is in the Fahrenheit scale. To change to Centigrade, depress either + or - of the “TIME” button until the description 0001 appears in the upper-left hand corner. To change back to the Fahrenheit scale, repeat the procedure until 0000 appears in the upper-left hand corner.

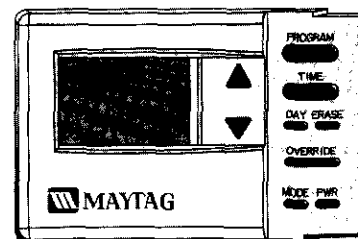

Instructions for Operation (cont'd)

Programming the Thermostat (cont'd)

The third optional mode (3) setting involves the default temperature set point for the control. To be in this mode, depress the up (▲) arrow or the down (▼) arrow until a large number 3 appears in the lower right-hand corner. The default temperature from the factory is 120°F. This will appear in the upper-left hand corner as 0120. To change the default setting, depress either + or - of the "TIME" button until the desired default temperature is displayed in the upper left-hand corner. The range for set point temperature is 80°F to 160°F.

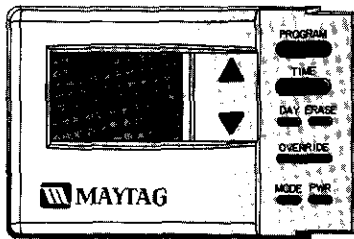

The fourth optional mode (4) setting involves the vacation temperature setting. This is factory set at 80°F or 0080 in the upper left-hand corner. To change the vacation default setting, make sure the optional mode is in the number (4) setting by depressing the up (▲) arrow or the down (▼) arrow button until a large number 4 is displayed in the lower right-hand corner. To change the vacation temperature default setting, depress either + or - of the "TIME" button until the desired vacation temperature is achieved in the upper left-hand corner of the display. The range for vacation default setting is 60°F to 120°F.

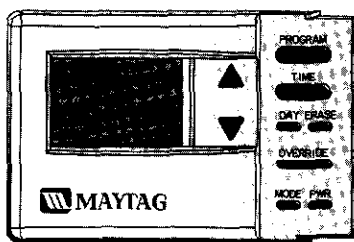

The fifth optional mode (5) setting involves the maximum temperature set point. To be this mode, depress the up (▲) arrow or the down (▼) arrow while in optional setting sequence until a large number 5 is displayed in the lower right-hand corner. The default factory maximum set point is 160°F or 0160 in the upper left-hand corner. To change this setting depress either + or - of the "TIME" button until the desired maximum set point is achieved in the upper left-hand corner. The range for maximum set point is 100°F to 160°F.

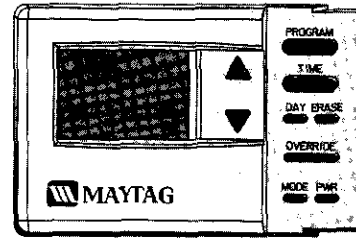

To return to regular operation of the program control, depress the "PROGRAM" and "MODE" buttons simultaneously again until the normal display appears. All the optional settings that were revised will remain until they are once again reset by using the above prescribed procedures.

SCALD WARNING is a flashing display warning any time the temperature is adjusted above 120°F. It represents an industry warning that water temperatures above 120°F represent a scald hazard when skin surface is exposed for a small amount of time. This is a warning and can not be removed from the screen display.

"PWR" (POWER) BUTTON is a button at the right-hand bottom of the panel which will activate or deactivate the display panel. **It will not turn off the power to the water heater and will not kill the power to the heating elements.**

▲ WARNING

HAZARD OF ELECTRICAL SHOCK! Before removing any access panels or servicing the water heater, make sure the electrical supply to the water heater is turned "OFF". Failure to do this could result in DEATH, SERIOUS BODILY INJURY, OR PROPERTY DAMAGE.

ELECTRICAL POWER OUTAGES will not effect the Intelligent programming or control settings. The unit has a battery backup that maintains the programmed settings until the electrical power is restored. At the time power is restored the program will again display the settings and information that had been available before the loss of power.

DRY FIRE PREVENTION is a feature that has been programmed into the Intelligent water heater. Should someone install or service the water heater and forget to fill the tank, the unit will sense a rapid heat cycle beyond normal expectations and disable the energy. A message will be displayed on the screen to add water, at which time the unit can be re-energized.

Service and Maintenance

Temperature-Pressure Relief Valve Operation

The temperature-pressure relief valve must be manually operated at least once a year.

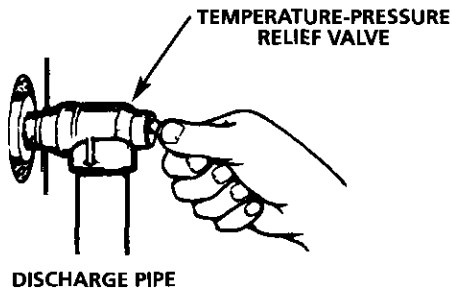

▲ WARNING

The temperature-pressure relief valve must be manually operated at least once a year. Caution should be taken to ensure that (1) no one is in front of or around the outlet of the temperature-pressure relief valve discharge line, and (2) the water manually discharged will not cause any property damage or bodily injury. The water may be extremely hot.

If after manually operating the valve, it fails to completely reset and continues to release water, immediately close the cold water inlet to the water heater, follow the draining instructions, and replace the temperature-pressure relief valve with a new one.

Failure to install and maintain a new properly listed temperature-pressure relief valve will release the manufacturer from any claim which might result from excessive temperature or pressure.

▲ WARNING

If the temperature-pressure relief valve on the appliance weeps or discharges periodically, this may be due to thermal expansion. Your water heater may have a check valve installed in the water line or a water meter with a check valve. Call Maytag Customer Service at 1-800-788-8899 for an authorized servicer. Do not plug the temperature-pressure relief valve.

Draining

The water heater should be drained if being shut down during freezing temperatures. Also periodic draining and cleaning of sediment from the tank may be necessary.

1. Before beginning turn "OFF" the electric power supply to the water heater.

▲ WARNING

HAZARD OF ELECTRICAL SHOCK! Before removing any access panels or servicing the water heater, make sure the electrical supply to the water heater is turned "OFF". Failure to do this could result in DEATH, SERIOUS BODILY INJURY, OR PROPERTY DAMAGE.

2. CLOSE the cold water inlet valve to the water heater.
3. OPEN a nearby hot water faucet and leave open to allow for draining.
4. Connect a hose to the drain valve and terminate to an adequate drain or outdoors.
5. OPEN the water heater drain valve to allow for tank draining.
NOTE: If the water heater is going to be shut down and drained for an extended period, the drain valve should be left open with hose connected allowing water to terminate to an adequate drain.
6. Close the drain valve.
7. Follow "Filling the Water Heater" instructions in the "Instructions for Installation" section.
8. Turn "ON" power to the water heater.

▲ CAUTION

Never use this water heater unless it is completely full water. To prevent damage to the tank and heating element, the tank must be filled with water. Water must flow from the hot water faucet before turning "ON" power.

Service and Maintenance (cont'd)

Element Cleaning/ Replacement

NOTE: These instructions are written for element cleaning and element replacement for the lower element. If it is necessary to clean or replace the upper element, then repeat these instructions.

To remove the element from your tank in order to clean or replace it:

1. Before beginning turn "OFF" the electric power supply to the water heater.

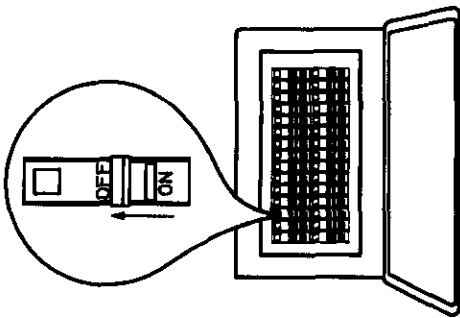

▲ WARNING

HAZARD OF ELECTRICAL SHOCK! Before removing any access panels or servicing the water heater, make sure the electrical supply to the water heater is turned "OFF". Failure to do this could result in DEATH, SERIOUS BODILY INJURY, OR PROPERTY DAMAGE.

2. Turn off the water supply to the water heater at the water shutoff valve or water meter.



3. Attach a hose to the water heater drain valve and put the other end in a floor drain or outdoors. Open the water heater drain valve. Open a nearby hot water faucet which will relieve pressure in the water heater and speed draining.

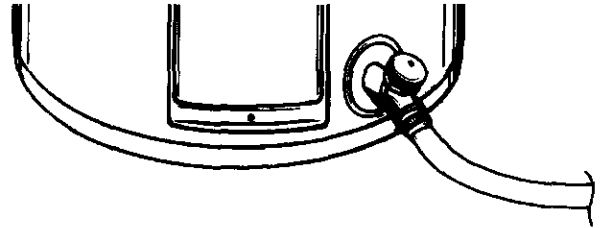

▲ WARNING

The water passing out of the drain valve may be extremely hot. To avoid being scalded, make sure all connections are tight and that the water flow is directed away from any person.

4. Remove the two screws securing the access panel, and remove panel.

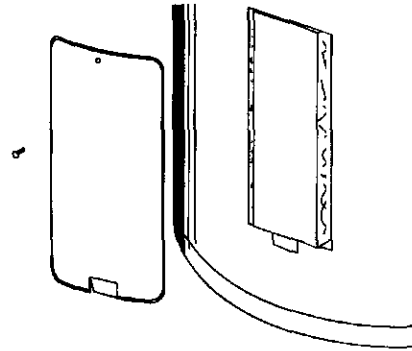

5. Remove the flap of insulation to expose the opening.

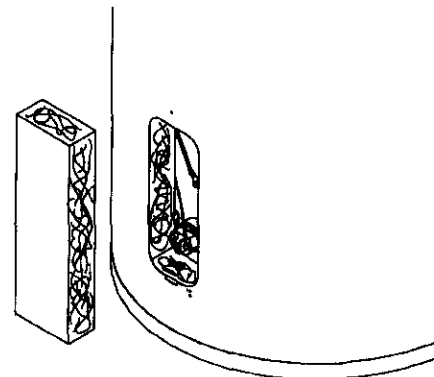

Service and Maintenance (cont'd)

6. Upper Element Only - Lift out the tab as shown to unclip the terminal cover from the high limit. The terminal cover can now be removed from the high limit.

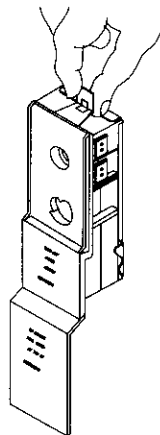

7. Disconnect the two wires on the element and unscrew the old element from the tank.

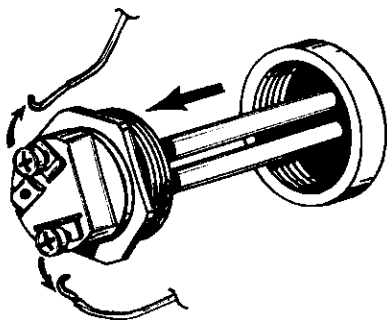

8. Clean the area around the element opening. Remove any sediment from or around the element opening and inside the tank.
9. If you are cleaning the element you have removed, do so by scraping or soaking in vinegar or a de-liming solution.

▲ WARNING

Replacement elements must (1) be the same voltage and (2) no greater wattage than listed on the model rating plate affixed to the water heater.

10. A new gasket should be used in all cases to prevent a possible water leak. (See Element Gasket in the Repair Parts Chart). Place the new element gasket on the thread side of the cleaned or new element and screw into tank, securing tightly using an element wrench.

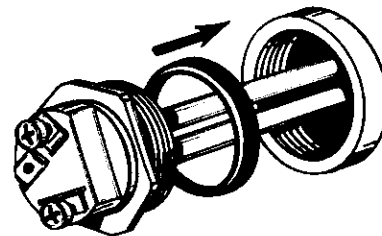

11. Close the water heater drain valve by turning the handle to the right (clockwise). The drain valve is on the lower front of the water heater.
12. Open the cold water supply valve to the water heater.

NOTE: The cold water supply valve must be left open when the water heater is in use.

13. To insure complete filling of the tank, allow air to exit by opening the nearest hot water faucet. Allow water to run until a constant flow is obtained. This will let air out of the water heater and the piping.

▲ CAUTION

Never use this water heater unless it is completely full of water. To prevent damage to the tank and heating element, the tank must be filled with water. Water must flow from the hot water faucet before turning "ON" power.

14. Check element for water leaks. If leakage occurs, tighten element or repeat steps 2 and 3, remove element and reposition gasket. Then repeat steps 11 through 15.

Service and Maintenance (cont'd)

Element Cleaning/ Replacement (cont'd)

15. Reconnect the two wires to the element and then check to make sure the high limit remains firmly against the surface of the tank.

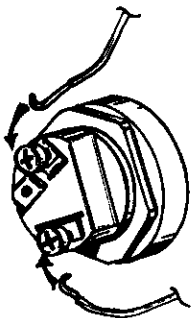

18. Replace access panel.
19. Turn "ON" electric power to water heater.

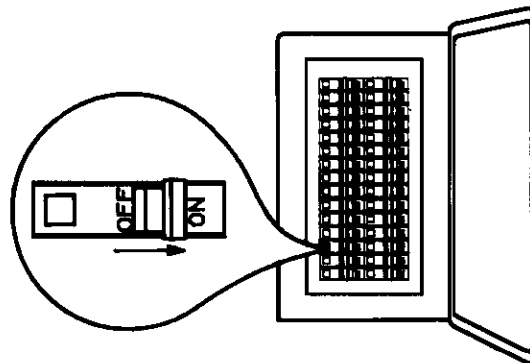

16. Upper High Limit Only - Replace terminal cover on high limit making sure that the locking tabs on the terminal cover are in place.

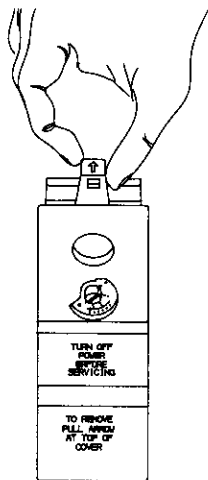

17. Press the insulation back in place so that it completely covers the thermistor, upper high limit and element.

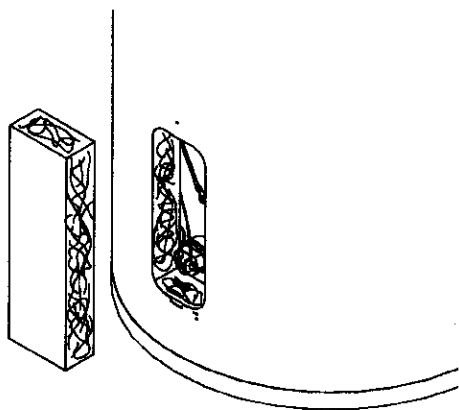

Service and Maintenance (cont'd)

Drain Valve Washer Replacement

NOTE: For replacement, use a $\frac{1}{32}$ " x $\frac{13}{64}$ " x $\frac{1}{8}$ " thick washer available at your nearest hardware store. For ordering a replacement washer, refer to the "Repair Parts" section.

1. Before beginning turn "OFF" the electrical power supply to the water heater.

▲ WARNING

HAZARD OF ELECTRICAL SHOCK! Before removing any access panels or servicing the water heater, make sure the electrical supply to the water heater is turned "OFF". Failure to do this could result in DEATH, SERIOUS BODILY INJURY, OR PROPERTY DAMAGE.

2. Follow "Draining" instructions in the "Service and Maintenance" section.
3. Turning counter clockwise, remove the hex cap below the screw handle.
4. Remove the washer and put the new one in place.
5. Screw the handle and cap assembly back into the drain valve and retighten using a wrench. **DO NOT OVER TIGHTEN.**
6. Follow "Filling the Water Heater" instructions in the "Instructions for Installation" section.
7. Check for leaks.
8. Turn "ON" electric power to the water heater.

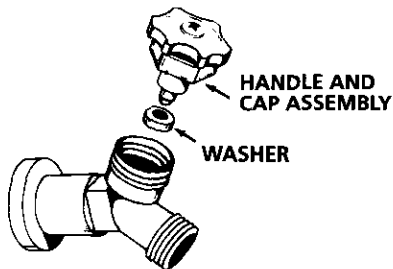

Service

Before calling for repair service, read the "Start Up Conditions" and "Operational Conditions" found in the "Troubleshooting" section of this manual.

If a condition persists or you are uncertain about the operation of the water heater, let a qualified person check it out.

Call Maytag Customer Service at 1-800-788-8899.

Troubleshooting

Start Up Conditions

THERMAL EXPANSION

Water supply systems may, because of such events as high line pressure, frequent cut-offs, the effects of water hammer among others, have installed devices such as pressure reducing valves, check valves, back flow preventers, etc...to control these types of problems. When these devices are not equipped with an internal by-pass, and no other measures are taken, the devices cause the water system to be closed. As water is heated, it expands (thermal expansion) and closed systems do not allow for the expansion of heated water.

The water within the water heater tank expands as it is heated and increases the pressure of the water system. If the relieving point of the water heater's temperature-pressure relief valve is reached, the valve will relieve the excess pressure. **The temperature-pressure relief valve is not intended for the constant relief of thermal expansion.** This is an unacceptable condition and must be corrected.

It is recommended that any devices installed which could create a closed system, have a by-pass and/or the system have an expansion tank to relieve the pressure built by thermal expansion in the water system. Expansion tanks are available for ordering through the Maytag Customer Service. Contact the local water supplier and/or call Maytag Customer Service at 1-800-788-8899 for an authorized servicer for assistance in controlling these situations.

STRANGE SOUNDS

Possible noises due to expansion and contraction of some metal parts during periods of heat-up and cool-down do not represent harmful or dangerous conditions.

Operational Conditions

SMELLY WATER

In each glasslined water heater there is installed at least one anode rod (see parts section) for corrosion protection of the tank. Certain water conditions will cause a reaction between this rod and the water. The most common complaint associated with the anode rod is one of a "rotten egg smell". This odor is derived from hydrogen sulfide gas dissolved in the water. The smell is the result of four factors which must all be present for the odor to develop:

- a. a concentration of sulfate in the supply water.
- b. little or no dissolved oxygen in the water.
- c. a sulfate reducing bacteria within the water heater. (This harmless bacteria is non-toxic to humans.)
- d. an excess of active hydrogen in the tank. This is caused by the corrosion protective action of the anode.

Smelly water may be eliminated or reduced in some water heater models by replacing the anode(s) with one of less active material, and then chlorinating the water heater tank and all hot water lines. Call Maytag Customer Service at 1-800-788-8899 for an authorized servicer for further information concerning an Anode Replacement Kit #66001068 and this Chlorination Treatment.

If the smelly water persists after the anode replacement and chlorination treatment, we can only suggest that continuous chlorination and filtering conditioning equipment be considered to eliminate the water problem.

Do not remove the anode leaving the tank unprotected. By doing so, all warranty on the water heater tank is voided.

"AIR" IN HOT WATER FAUCETS

▲ WARNING

HYDROGEN GAS: Hydrogen gas can be produced in a hot water system that has not been used for a long period of time (generally two weeks or more). Hydrogen gas is extremely flammable and explosive. To prevent the possibility of injury under these conditions, we recommend the hot water faucet be opened for several minutes at the kitchen sink before any electrical appliances which are connected to the hot water system are used (such as a dishwasher or washing machine). If hydrogen gas is present, there will probably be an unusual sound similar to air escaping through the pipe as the hot water faucet is opened. There must be no smoking or open flame near the faucet at the time it is open.

RUMBLING NOISE

In some water areas, scale or mineral deposits will build up on your heating elements. This buildup will cause a rumbling noise. Follow "Element Cleaning/Replacement" instructions to clean and replace the elements.

HIGH TEMPERATURE SHUT OFF SYSTEM

The water heater has a high limit shut off system with a reset button located above the upper element.

Follow the resetting instructions which refer to the high limit behind the access panel.

Troubleshooting (cont'd)

Operational Conditions (cont'd)

HIGH TEMPERATURE SHUT OFF SYSTEM

1. Before beginning, turn "OFF" electrical power supply to the water heater.

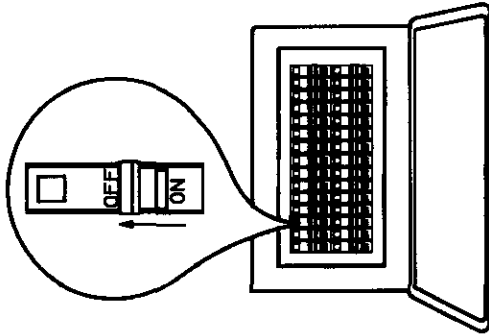

▲ WARNING

HAZARD OF ELECTRICAL SHOCK! Before removing any access panels or servicing the water heater, make sure the electrical supply to the water heater is turned "OFF". Failure to do this could result in DEATH, SERIOUS BODILY INJURY, OR PROPERTY DAMAGE.

2. Remove the two screws securing the upper access panel and remove panel.
3. Remove the flap of insulation to expose the opening.
4. Reset the high limit by pushing in the red button marked "RESET".

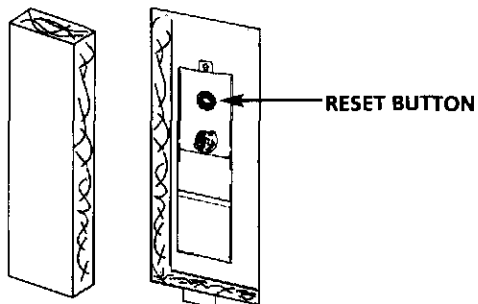

5. Press the insulation back in place so that it completely covers the high limit and element.
6. Replace the upper access panel.
7. Turn "ON" electric power to the water heater.

▲ CAUTION

If the high limit must be reset again, call Maytag Customer Service at 1-800-788-8899 for an authorized servicer to find out why the high limit turned "OFF" the electric power.

NOT ENOUGH OR NO HOT WATER

1. In a new installation, the water heater may not be properly connected. Make sure the cold water supply valve is open. Review and check piping installation. Make sure that the cold water line is connected to the cold water inlet to the water heater and the hot water line to the hot water outlet on the water heater.
2. Make sure the electrical supply to your water heater is "ON".
3. Check for loose or blown fuses in your water heater circuit. Circuit breakers weaken with age and may not handle their rated load and should be replaced.
4. Make certain the disconnect switch, if used, is in the "ON" position.
5. Check to see the electric service to your house has not been interrupted. If this is the case, contact the electric company.
6. Is the programmable thermostat set to the desired temperature? See "Temperature Regulation" section.
7. If you had experienced very hot water and now no hot water, the problem may be due to the high temperature shut off system. See "High Temperature Shut Off System" in the "Troubleshooting" section.
8. During very cold weather, the incoming water will also be colder and it will require a longer time to become heated.
9. The hot water usage may exceed the capacity of the water heater. If so, wait for water heater to recover after abnormal demand. Also examine pipes and faucets for possible water leaks.
10. If you can not determine the problem, then call the Maytag Service Department.

WATER IS TOO HOT

Adjust the thermostat to a lower setting. See the "Temperature Regulation" section on page 23.

Troubleshooting (cont'd)

Operational Conditions (cont'd)

THERMOSTAT DIAGNOSTICS

The programmable thermostat will use the upper and lower temperature sensors (thermistors) to determine when either the upper or lower heating element is not functioning. It can also detect a faulty temperature sensor. The thermostat will use the service icon and its associated codes to indicate the specific failure condition and will also save the last failure condition.

To display the last failure, depress and hold the up (▲) arrow or the down (▼) arrow button for 4 seconds while in the normal run mode. Be Careful; **depressing the “ERASE” button while the last failure is displayed will erase the stored failure.**

1. **No Water/Dry Fire Warning** – If the sensors indicate a rise in temperature greater than 50°F in the first minute after power-up, the control will display a “NO WATER” icon indicating that there is no water in the tank. This will immediately shut off power to both elements.

▲ CAUTION

This will not discontinue power from the water heater.

2. **Upper Temperature Sensor Failure** – If the upper sensor is either open or shorted, the “SERVICE” icon and the letters “U” and “S” will be displayed. The thermostat will then use only the lower heating element and lower temperature sensor to control the water temperature until the upper sensor has been replaced.

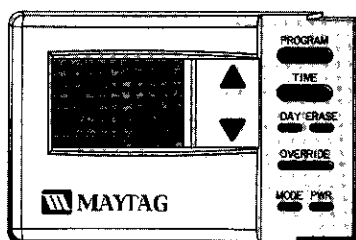

3. **Lower Temperature Sensor Failure** – If the lower sensor is either open or shorted, the “SERVICE” icon and the letters “L” and “S” will be displayed. The thermostat will then use only the upper heating element and upper temperature sensor to control the water temperature until the lower sensor has been replaced.

4. **Upper Element Failure** – Tests after 90 minutes of continuous upper element heating without an increase in upper water temperature. The thermostat turns off the upper element and tries for 30 minutes to raise the temperature of the upper sensor using the lower element. If the upper temperature sensor rises using the lower element, the upper element will again be tried. After 30 minutes, if the upper element does not raise the upper water temperature on the second attempt, then an upper element failure will be indicated by displaying the “SERVICE” icon and the letters “U” and “E”. The lower element will only be used to heat the water until the upper element has been replaced.

5. **Lower Element Failure** – After 120 minutes of continuous lower element heating without an increase in lower water temperature, lower element failure will be indicated by displaying the “SERVICE” icon and the letters “L” and “E”. Replace the lower heating element.

6. **High Limit Device Failure** – If a lower element failure occurs when the upper element has also failed, the thermostat will determine that the high limit device has failed. High limit device failure will be indicated by displaying the “SERVICE” icon and the letter “C”. Replace the high limit device.

7. **Re-Check** – The system will run a failure event sequence three (3) times before it assumes a final service code.

Troubleshooting (cont'd)

Leakage Checkpoints

Use this guide to check a "Leaking" water heater. Many suspected "Leakers" are not leaking tanks. Often the source of the water can be found and corrected.

If you are not thoroughly familiar with electric codes, the water heater, and safety practices, contact your local utility or call Maytag Customer Service at 1-800-788-8899 for an authorized servicer to check the water heater.

- (A) * Condensation may be seen on pipes in humid weather or pipe connections may be leaking.
- (B) * The primary anode rod may be leaking.
- (C) Small amounts of water from temperature-pressure relief valve may be due to thermal expansion or high water pressure in your area.
- (D) * The temperature-pressure relief valve may be leaking at the tank fitting.
- (E) The elements may be leaking at the tank fitting.

▲ WARNING

HAZARD OF ELECTRICAL SHOCK! Before removing any access panels or servicing the water heater, make sure the electrical supply to the water heater is turned "OFF". Failure to do this could result in DEATH, SERIOUS BODILY INJURY, OR PROPERTY DAMAGE.

Turn electrical power "OFF", remove access panels and fold back insulation. If leaking around elements, follow proper draining instructions and remove element. Reposition or replace gasket on element. Place element into opening and tighten securely. Then follow "Filling the Water Heater" instructions in the "Instructions for Installation" section.

- (F) Water from drain valve may be due to the valve being opened slightly.
- (G) * The drain valve may be leaking at the tank fitting.
- (H) * Water in the water heater bottom or on the floor may be from condensation, loose connections or the temperature-pressure relief valve. DO NOT replace the water heater until a full inspection of all possible water sources is made and necessary corrective steps taken. Leakage from other appliances, water lines, or ground seepage should also be checked.

***NOTE:** To check where threaded portion enters tank, insert cotton swab between jacket opening and fitting. If cotton is wet, follow "Draining" instructions in the "Service and Maintenance" section and then remove fitting. Put pipe dope or teflon tape on the threads and replace. Then follow "Filling the Water Heater" instructions in the "Instructions for Installation" section.

▲ CAUTION

Read this manual first, then before checking the water heater make sure the electric supply has been turned "OFF", and never turn the electric supply "ON" before the tank is completely full of water.

▲ CAUTION

Never use this water heater unless it is completely full of water. To prevent damage to the tank and heating element, the tank must be filled with water. The water must flow from the hot water faucet before turning "ON" power.

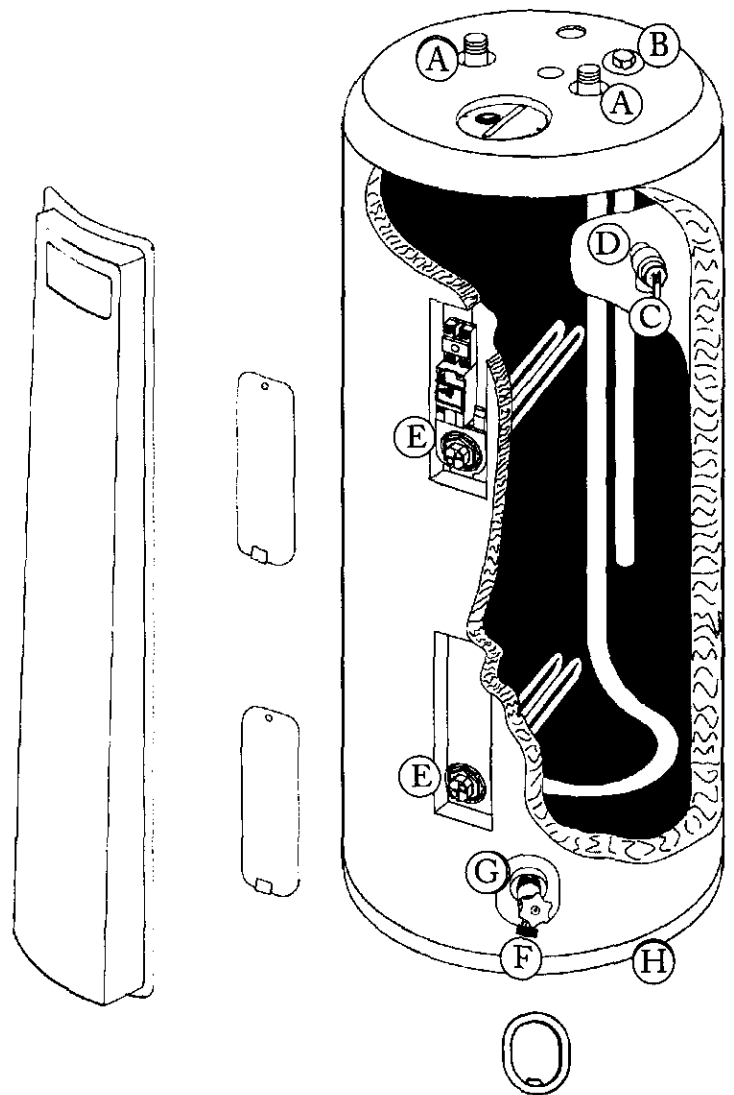

Repair Parts List

MAYTAG ELECTRIC WATER HEATERS

MAYTAG/STATE PART NUMBER CONVERSION KEY	
MAYTAG	STATE
66001010	9002403
66001011	9001609
66001012	9001608
66001013	ETC2X
66001014	ETC5X
66001016	9002402
66001021	9001584
66001034	9002445
66001053	9000308
66001054	9000309
66001055	9001591
66001056	9002439
66001059	9002406
66001061	9002408
66001063	9002409
66001066	9002416
66001067	9002058
66001068	9001453
66001105	9002769
66001106	9000225
66001107	9000396
66001108	9002988
66001110	9001792
66001111	9001672
66001353	9003034
66001354	9003035
66001355	9003036
66001356	9003037
66001357	9003038
66001358	9003039
66001440	0002919280

Repair Parts List (cont'd)

MAYTAG ELECTRIC WATER HEATERS MODEL NUMBERS

HE21250PC 50 GALLON
HE21282PC 80 GALLON

KEY NO.	PART DESCRIPTION	MODEL NUMBERS	
		HE21250PC	HE21282PC
1.	Temperature-Pressure Relief Valve	66001010	66001010
2.	Heat Trap Nipple	66001108	66001108
3.	Pipe Insulation (2 each)	66001034	66001034
4.	Dip Tube	66001066	66001067
5.	Primary Anode	66001111	66001111
6.	Secondary Anode/Heat Trap Nipple	66001110	66001110
7.	Drain Valve	66001016	66001016
8.	Drain Valve Washer (17/32" x 13/64" x 1/8" thick)*	66001021	66001021
9.	Drain Cover	66001063	66001063
10.	Element Gasket	66001053	66001053
11.	Lower Element	SEE NOTE ON PAGE 38	
12.	Buss Bar Kit	66001055	66001055
13.	Lower Temperature Sensor	66001358	66001358
14.	Lower Access Panel	66001059	66001059
15.	Transformer/Relay Panel	66001356	66001356
16.	Transformer/Relay Board	66001354	66001354
17.	Panel	66001061	66001061
18.	Upper Access Panel	66001059	66001059
19.	Terminal Cover (Upper)	66001056	66001056
20.	Hi Limit w/ECO	66001355	66001355
21.	Hi Limit Bracket	66001054	66001054
22.	Upper Temperature Sensor	66001358	66001358
13.	Upper Element	SEE NOTE ON PAGE 38	
24.	Element Gasket	66001053	66001053
25.	Programmable Thermostat	66001353	66001353
#	Remote Thermostat Cable (50 ft.)	66001357	66001357
#	Manual	66001469	

*Also available at most hardware stores.

#Not Illustrated

Now that you have purchased this water heater, should a need ever exist for repair parts or service, simply call Maytag Customer Service at 1-800-788-8899 for an authorized servicer. Be sure to provide all pertinent facts when you call or visit.

The model number of the water heater will be found on the model rating plate located above the access panel.

WHEN ORDERING REPAIR PARTS, ALWAYS GIVE THE FOLLOWING INFORMATION:

- Model Number
- Serial Number
- Part Description
- Part Number

THIS IS A REPAIR PARTS LIST, NOT A PACKING LIST.

Warranty

FULL ONE YEAR WARRANTY

For One Year from the date of Original Retail Purchase, any part which fails in normal home use will be repaired or replaced free of charge.

If a leak occurs in the Tank, a new water heater of the closest capacity and quality then available, will be replaced free of charge.

The warranty of the replacement is the balance of the original water heater's Warranty.

LIMITED PARTS WARRANTY

After the First year and through the Twelfth Year from the date of Original Retail Purchase, any Parts which fail due to a defect in materials or workmanship, will be replaced or repaired free of charge for the part itself, with the owner paying all other costs, including labor, mileage and transportation.

If the water heater is subjected to commercial, institutional, industrial or non-residential use, the above warranty coverage for parts that are proved to be defective in material or workmanship is effective for one year from the date of the Original Retail Purchase.

The warranty of the replacement is the balance of the original water heater's Warranty, or twelve months from the date of the part(s) purchase, whichever comes first.

The warranty is limited to the original owner of the water heater.

LIMITED TANK WARRANTY AGAINST LEAKS

After the First Year and through the Twelfth Year from the date of Original Retail Purchase, if a leak occurs in the Tank, a new water heater of the closest capacity and quality then available, will be replaced free of charge for the water heater, with the owner paying all other costs, including labor, mileage and transportation.

If the water heater is subjected to commercial, institutional, industrial or non-residential use, the above warranty coverage for tanks that are proven to be defective in material or workmanship is effective for two years from the date of the Original Retail Purchase.

The warranty of the replacement is the balance of the original water heater's Warranty.

Please note: The Full and Limited Warranty applies only while this water heater is used in the United States of America.

The warranty is limited to the original owner of the water heater.

TO RECEIVE WARRANTY SERVICE

To locate an authorized service company in your area contact the Maytag dealer from whom your appliance was purchased; or call Maytag Customer Service at the number listed below. Should you not receive satisfactory warranty service, please call or write:

Maytag Customer Service
P.O. Box 2370
Cleveland, TN 37320-2370
U.S.A. 1-800-788-8899

When contacting Maytag Customer Service be sure to provide the Model and Serial Number of your appliance, The Name and Address of the Dealer from whom you purchased the appliance and the Date of Purchase.

MAYTAG WATER HEATERS ARE MANUFACTURED AND THIS WARRANTY PROVIDED BY STATE INDUSTRIES, INC., ASHLAND CITY, TN. MAYTAG IS A TRADEMARK OF MAYTAG CORPORATION AND IS USED UNDER LICENSE TO STATE INDUSTRIES, INC.