



Partner in Growing



User Manual

Original document

version 2014-1-2

Plus M 2.0 Potmachine

Machine nr.:



Javo BV
PO Box 21
2210 AA Noordwijkerhout
Holland
T: +31 (0)252 343121
F: +31 (0)252 377423
info@javo.eu
www.javo.eu

© All rights reserved

The information provided herein may not be reproduced and/or published in any form, by print, photo print, microfilm or any other means whatsoever (electronically or mechanically) without the prior written authorisation of JAVO BV.

Preface

This user manual is written for anyone working on or with the machine. Before working on or with the machine, first read this manual.

This user manual contains important instructions / information on how to use the machine in a safe, professional and economical way and must always be available where the machine is used.

In addition to this user manual, the mandatory rules and regulations for accident prevention and environmental protection in the country and place of use of the machine must also be observed.

This user manual contains information on the operation of the machine with all the possible options. Use only the information that applies to your machine. Depending on the intensity of use and customer requirements, this machine can be equipped with various options. Contact your sales consultant.

Supplier details if not directly supplied by Javo BV. Dealer stamp:



Javo BV is not responsible for any errors in this manual or the consequences thereof.

Javo BV is not liable for damage or consequential damage caused by operating errors, lack of expert maintenance and any use other than described in this manual.

The liability of Javo BV also expires once modifications or additions are made without written permission of Javo BV.

This machine is suitable for process and environmental conditions as stated in section "Specifications and Tolerances" of this manual. Any other use is not authorized by Javo BV and this allows the operator and / or its environment at risk.

Table of contents

1	Technical specifications and tolerances	4
1.1	Type plate.....	4
2	Safety	5
2.1	Provisions	5
2.2	Safety devices on the machine	6
2.3	Explanation of icons and symbols.....	6
3	Description of the machine	7
3.1	Machine overview.....	7
3.2	Outline drawing with main dimensions	7
3.3	Options.....	8
3.4	Operation	8
3.5	Machine workstations.....	8
3.6	Controls.....	9
4	Transport	10
5	Mounting, installation and commissioning	11
5.1	Placement	11
5.2	Facilities to take care of by the user	11
5.3	Mounting / Connecting.....	11
5.4	Check elevator rotation direction	11
5.5	Check drill rotation direction	12
5.6	Check substrate conveyor tension.....	12
5.7	Check elevator belt tension	12
5.8	Set elevator speed	13
5.9	Set pottrack speed	13
5.10	Set brush height.....	13
5.11	Set substrate slide height.....	14
5.12	Set pottrack dimensions	14
5.13	Set drill size	15
5.14	Set substrate valve	15
5.15	Moving the exit conveyor (optional)	16
6	Operation	18
6.1	Start.....	18
6.2	Stop	18
6.3	Emergency stop.....	18
7	Maintenance	19
7.1	Required tools and equipment	19
7.2	Preventive Maintenance.....	19
7.3	Empty substrate bin	20

7.4	Lubricate drill unit	21
7.5	Elevator Blades Cleaning	21
7.6	Test safety circuit	21
7.7	Fault list	22
7.8	Adjust substrate conveyor to larger stroke	23
7.9	Drawings and schemes.....	23
7.10	Spare parts	23
7.11	JavoNet.....	23
7.12	Customer support and advice.....	23
8	Disposal of machine or machine parts	23
9	EG-conformity statement.....	24

1 Technical specifications and tolerances

This machine is intended to be used for filling pots automatically with substrate only. The filled jars are then provided with a drill hole, in which a plant can be placed at the exit conveyor. This machine is meant for processing pots, substrate and other materials that are described in this manual only. Detailed operation of the machine is described in section "Operation".



This machine may be used only within the limits for specifications and tolerances of the order, on the assembly drawing and indicated in this manual. If the machine is used outside these specifications, Javo BV cannot take responsibility for this machine.



This machine is intended for products as agreed in the order confirmation only. To ensure the proper operation of this machine, only products with specifications and tolerances as specified in the order may be used.



Do not use the machine for purposes other than the intended purpose of Javo BV. This can lead to damage and danger to the operator and its environment.





This machine is CE marked. When placing multiple machines in one line, the entire line must be properly CE marked before using this machine. Until proper CE Marking of the line is carried out, commissioning of this machine is prohibited.

Specifications	
Voltage	400Volt 50Hz 3~+N+ PE / 220Volt 60Hz
Machine connection	16A 5pole
Power consumption	5,5 kW
Switched socket	1x 16A 5 pole
Weight	±1750 kg
Height conveyor	805 mm
Max. speed	3100 p. /hour (50Hz)
Min. speed	1240 p. /hour (15 Hz)
Minimum pot diameter	10 cm
Maximum pot diameter	32 cm (10 Litre)
Number of potholders	16
Content substrate bin	±1100 Litre (1,1 m ³)
Drillbush (motor shaft size 19 mm)	Drill shaft 14 mm (up to drill 15 cm)
Operation	Loose controls with stop/start/e-stop/reset.
Inverter elevator	Standard (controlled on electrical cabinet)
Inverter pottrack	Standard (controlled on electrical cabinet)
Wheels	Heavy bearing wheels, rear castors
Stekplate	Standard height adjustable
Circulation rail	Edges removable at all positions. Rail divisible.
Year of construction	See type plate
Type product	As agreed in the order confirmation.
Air (optional)	6 Bar; 250 nL/min.

1.1 Type plate

The type plate is placed onto the main cabinet door.

Partner in Growing

Westeinde 4 2211 XP Noorwijkerhout Nederland
www.javo.eu info@javo.eu

Type	
Machine nr.	
Bouwjaar	
<input type="text"/> V <input type="text"/> kW	
<input type="text"/> A <input type="text"/> Hz	



2 Safety



This machine is built according the state of the art technique and the accredited safety regulations. Despite this, the body and life from the user or third parties can be in danger when using it. There could also arise damage to the machine or other goods when using it.



This machine is CE marked. When placing multiple machines in one line, the entire line must be properly CE marked before using this machine. Until proper CE Marking of the line is carried out, commissioning of this machine is prohibited.

2.1 Provisions

1. Operation and maintenance of this machine must be performed by qualified personnel in compliance with warnings on the machine and in accordance with the user manual. Keep children and other (unauthorized) persons away while using machine.
2. This machine is suitable for process and environmental conditions as stated in section "Specifications and Tolerances" of this manual only. Any other use is not authorized by Javo BV and this allows the operator and / or the environment at risk.
3. It is prohibited to modify this machine, without prior written approval of Javo BV.
4. Thermal fuses and torque limiters may not be set different upon delivery of the new machine. The thermal circuit breakers should never be used to turn on / off the machine.
5. This machine should be installed so that there is sufficient space remaining for providing safe instructions and / or performing maintenance and / or inspections. Put the brakes on the castors before the machine is turned on.
6. Keep the work area clean and well lit. Cluttered or dark areas invite accidents.
7. This machine is not suitable to be used outside. Electrical components are only splash proof. Keep the machine away from rain and moisture. When using the machine in a humid environment is unavoidable, you should use an RCD.
8. Keep hands, hair, loose clothing and / or jewellery away from moving parts of the machine. Wear appropriate clothing without loose parts. Wear non-slip work shoes.
9. As long as the machine is on, no connection or safety devices may be removed. The machine may only be used when all protective devices and safety-related facilities are available and ready for use.
10. Do not stand on the machine when it is operating.
11. Never move the machine if the power cable and / or pneumatic supply is still connected.
12. Prescribed checks and maintenance in the user manual must be observed.
13. Allow the machine to be serviced and repaired by qualified personnel only with original replacement parts.
14. In addition to the user manual, generally applicable statutory and other regulations regarding accident prevention and environmental protection have to be respected. This is also referred to handling of personal protective equipment.
15. Inform operating personnel before start maintenance. Interrupt if possible the power (mains), before start machine investigation or maintenance by turning off the main switch and locking the main switch. Pull the plug from the wall socket.
 - a. As work must be done with power supply (mains) voltage on the machine, then arrange an additional person who can operate the emergency stop.
16. When a machine part is damaged or not working in the prescribed manner, the work must be interrupted immediately. Resumption allowed only when the machine part is repaired or replaced and checked. Consult your dealer if the machine is not functioning properly.
17. Machine and / or parts must be disposed in accordance with local laws and regulations.

2.2 Safety devices on the machine



Caps and doors are screening moving parts. Always place back caps and close doors before the machine is turned on. Caps and doors should remain closed while operating the machine.

The motors of the machine are protected against overload by thermal switches. These switches are located in the control box.

2.3 Explanation of icons and symbols

Pictogram	Meaning
	Read and understand this manual before using the machine and / or performing maintenance.
	Remove Power (mains).
	Wear during all work on or with the machine safety shoes and safety glasses.
	Wear during cleaning and maintenance work on this machine also safety gloves and protective clothing.
	Warning. Important points and / or instructions regarding safety and / or injury prevention are marked with this warning sign.
	Dangerous electrical voltage. Dangerous electrical voltage present.
	Risk of crushing. Danger of moving or rotating parts.
	It is forbidden to wear Loose clothing, long hair and / or jewellery nearby moving parts of the machine.
	Trespassing.
	Do not rinse control cabinet Danger of moisture in the cabinet when it is rinsed with water.

Symbols that may be present on this machine			
Drill 	Direction of movement 	Speed ground feeder (curved) 	Speed ground feeder (straight)
Speed pot belt (curved) 	Speed pot belt (straight) 	Brush disc Rotofill 	Tray belt Rotofill
Rotor Rotofill 			

3 Description of the machine

3.1 Machine overview

- A. Substrate bin
- B. Elevator *
- C. Drill *
- D. Pottrack
- E. Pot erector (optional)

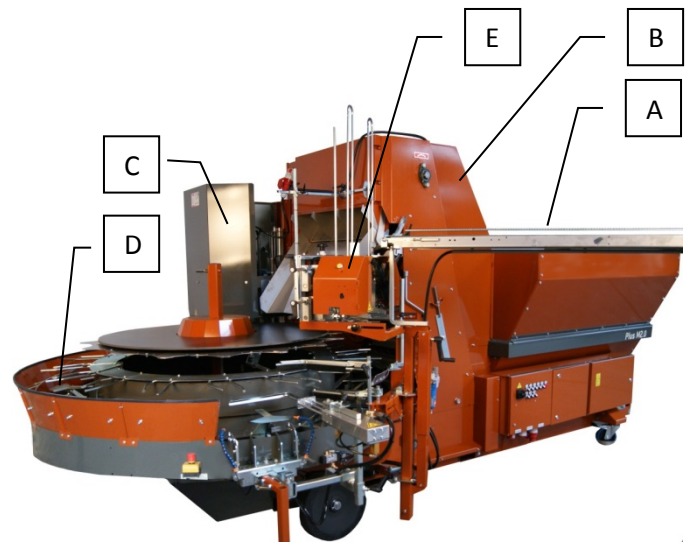

* Moving parts of the machine are protected by hoods and doors when the machine was delivered.

3.2 Outline drawing with main dimensions

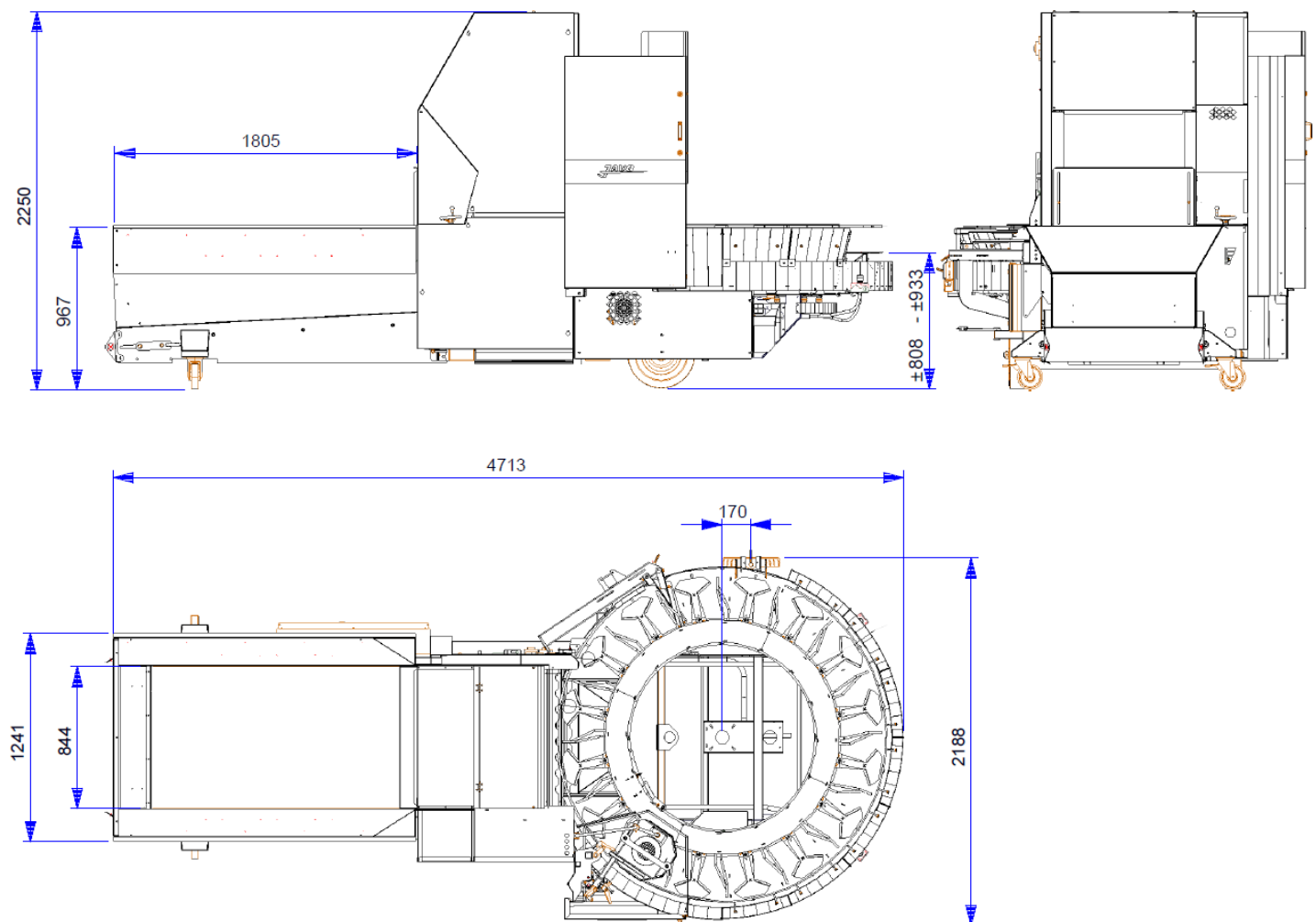

3.3 Options

Depending on the intensity of use and customer requirements, this machine can be equipped with various options. Contact your sales consultant.

Options	Code	Specifications
4 meter 5x1.5 cable incl. 16A plug	900965	
Continuous socket	900966	Nonstandard
Height pottrack		Standard 805. Extra up 6x 25mm
Substrate bin increasement	223-180	1600 Litre extra (1,6m ³) (1800x1660x600)
Pneumatic tires set incl. Swivelling front wheels and triangle	SU1ZL	Wheels outside the machine
Roller with motor	223-500-01-02	With inverter
Rotating brush prior to drill	BM 223	
Rotating brush post drill	BM 201	

3.4 Operation

The process of the machine starts with the soilbin, which is filled with substrate. By using the soil conveyor belt and return belt, the soil is transferred to the elevator.

The elevator takes over the soil and transfers it onto pots, which have been placed on the pottrack. The pottrack is adjustable in height and width so that it is applicable to different pot sizes.

The pottrack move the pots to the drill which makes holes in the ground. The hole depth and diameter are adjustable. After making a drill hole, the pots are transferred over the pottrack to a conveyor belt.

The machine is equipped with wheels, which makes the machine easy to move.

3.5 Machine workstations

This machine has operator places at the pottrack and conveyor belt.

3.6 Controls

The motor is controlled with the control panel. The control panel consists of the following buttons;

- A. Stop button
- B. Start button
- C. Reset button
- D. Emergency stop button

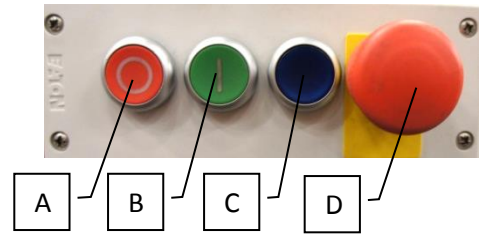

At the electrical cabinet of the machine, these buttons and connectors are placed:

- A. Drill off / on
- B. Pottrack off / on
- C. Elevator off / on
- D. Stopped / Error indication
- E. Main switch
- F. Dispenser continuous / not continuous
- G. Timer off / on
- H. Substrate conveyor off / on
- I. Continuous power IN
- J. Switched power OUT (optional)
- K. Continuous power OUT (optional)

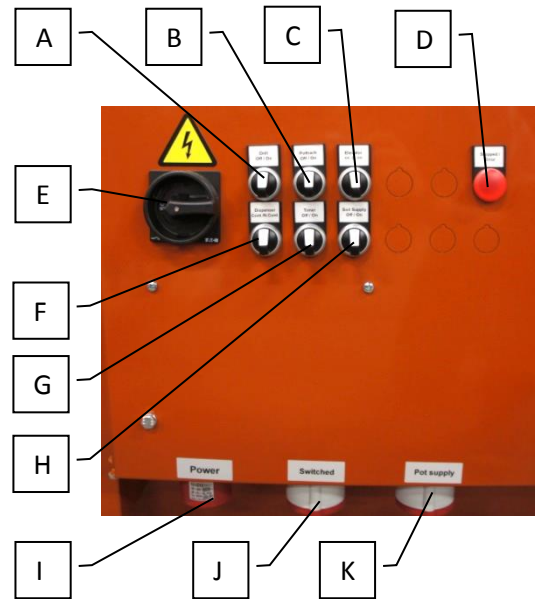

Potentiometers for speed settings (optional):



4 Transport



Follow all instructions described in this manual, in particular chapter safety.

On delivery of the machine, a Javo mechanical engineer must be present to unload the machine from the (freight) wagon.

Prior to moving the machine, the power should be disconnected. Make sure the cables are stowed sufficiently.

When moving within the company (when the machine does not need to be lifted) the state of the machine should be checked. Make sure the path to be travelled is free, so the machine can be moved to the desired position without obstacles.

If the machine is to be lifted for movement (outside the company), please contact your dealer or contact a professional shipping company.

Before the machine can be moved, the conveyor belt must be removed.
The machine must be transported upright.

The relative humidity should not be too high so that water condenses in the machine.

Report damage during or immediately after delivery to the transport company and to Javo BV. Take all necessary steps to prevent further damage.

5 Mounting, installation and commissioning



Follow all instructions described in this manual, in particular chapter safety.



This machine is CE marked. When placing multiple machines in one line, the entire line must be properly CE marked before using this machine. Up to CE Marking of the line, commissioning of this machine is prohibited.

5.1 Placement

The machine must be placed on a flat surface, with sufficient weight capacity. Install the machine so that there is enough space left for service providing, safe instructions and / or cleaning, maintenance and / or inspections. Put the brakes on the castors before the machine is turned on.



This machine is not suitable to be used in the open air. Electrical components are only splashproof. Keep the machine away from rain and moisture. When using the machine in a humid location is unavoidable, you should use an RCD.

5.2 Facilities to take care of by the user

Prior to delivery of the machine, the required materials and facilities (air, power, substrate, etc.) needs to be present within 3 meters of machine.

Required power supply: 400 Volt, 3 Phase + Neutral + Earth. (N. America: 208/220V 60Hz.).

5.3 Mounting / Connecting

If applicable, the components supplied are to be mounted on the machine. Make sure that the moving parts are free. If the machine is complete, it can be connected (by a competent person) to the power supply.



Keep hands, hair, loose clothing and / or jewellery away from moving parts of the machine. Wear appropriate clothing without loose parts. Wear non-slip work shoes.



As long as the machine is on, no connection or safety devices may be removed. The machine may only be used when all protective devices and safety-related facilities are available and ready for use.

5.4 Check elevator rotation direction



Check the rotation direction of the elevator before you start working with the machine.

Procedure:

1. Connect the power cable.
2. Start the elevator.
 - a. Turn off the main switch.
 - b. Press the reset button emergency stop circuit.
 - c. Start the elevator with the elevator button.
3. Check the direction of rotation of the elevator.
 - a. The desired rotation direction is shown in this picture.
4. Stop the elevator by turning the main switch off.
5. When rotation direction is incorrect:
 - a. Remove the plug from the socket.
 - b. Open the plug and switch 2 of the 3 phases in the plug. This should only be carried out by suitably qualified personnel.

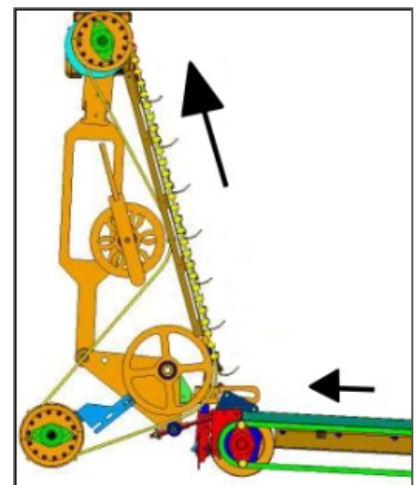

5.5 Check drill rotation direction



Check the rotation direction of the drill before you start working with the machine.

Procedure:

1. Connect the power cable.
2. Start the drill.
 - a. Turn on the main switch.
 - b. Press the reset button emergency stop circuit.
 - c. Start the drill with the drill button.
3. Check the direction of rotation of the drill.
 - a. The desired rotation direction is shown in this picture.
4. Stop the drill by turning the drill switch off.
5. Switch off the main switch.
6. When rotation direction is incorrect:
 - a. Remove the plug from the socket.
 - b. Open the plug and switch 2 of the 3 phases in the plug. This should only be carried out by suitably qualified personnel.

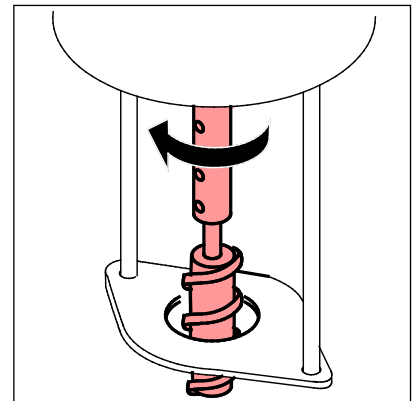

5.6 Check substrate conveyor tension



Check the substrate conveyor belt tension before you start working with the machine.

Procedure:

1. Check the substrate conveyor belt tension. The correct tension is obtained when the belt in the middle deflects $\pm 40\text{mm}$.
2. Adjust the belt tension if necessary .
 - a. Loosen the four screws (B) to the block bearings.
 - b. The tension can be adjusted by simultaneously turning both sides of the ground belt (A).
 - c. Tighten the four screws (B) to the block bearings.

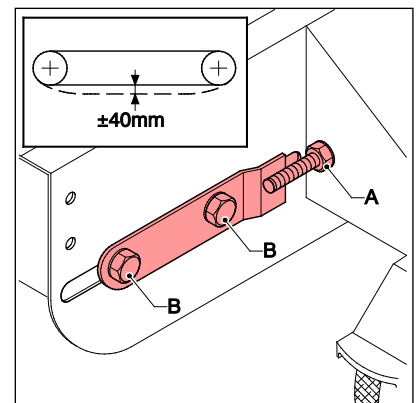

5.7 Check elevator belt tension



Check the elevator belt tension before you start working with the machine.

Procedure:

1. Check the elevator belt tension. The correct tension is obtained when the belt in the middle deflects $\pm 20\text{mm}$.
2. Adjust the belt tension if necessary .
 - a. The tension can be adjusted using the two clamping nuts, located on opposite sides of the elevator housing.
 - b. Tighten the nuts (A) on both sides of the elevator equally.

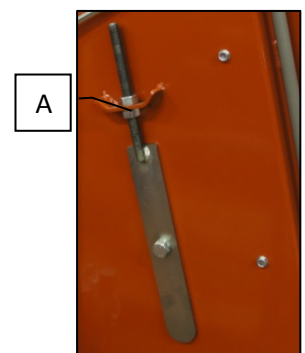

The tension of the belt should not be too tight.

5.8 Set elevator speed



Set the elevator speed before you start working with the machine.

Procedure:

1. Check the elevator speed.



Adjust the speed of the conveyor belt only when engines are running.

2. When the speed needs to be adjusted:
 - a. Adjust the potentiometer for elevator speed.



5.9 Set pottrack speed



Set the pottrack speed before you start working with the machine.

Procedure:

1. Check the pottrack speed.



Adjust the speed of the pottrack only when engines are running.

2. When the speed needs to be adjusted:
 - b. Adjust the potentiometer for pottrack speed.



5.10 Set brush height



Set the brush height before you start working with the machine.

The brush wiper controls the amount of soil on top of the pot.

Procedure:

1. Check the brush height in comparison with the pot.
2. When the speed needs to be adjusted:
 - a. Loosen clamp (B).
 - b. Set the desired brush height with (B).
 - c. The more substrate on top of the pot, the stronger the pressure plate of the drill press down the substrate in the pot.
 - d. Tighten clamp (B).

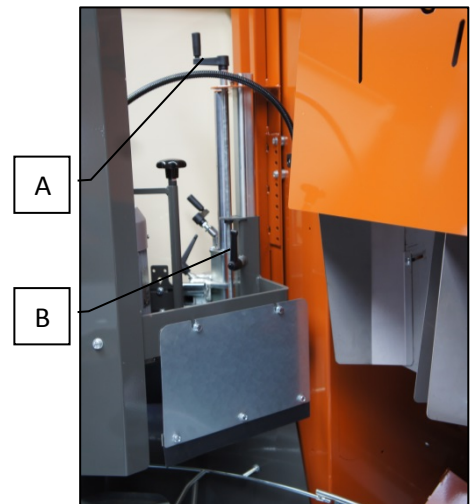

5.11 Set substrate slide height



Set the height before you start working with the machine.

Adjust the height of the substrate slide so that there is not too much substrate supplied by the substrate conveyor. Set the substrate slide as low as possible to avoid accumulation of substrate in the machine. When changing from large to small pots, the soil slide should be set lowered.



5.12 Set pottrack dimensions



Set the pottrack dimensions before you start working with the machine.

The pottrack fingers are adjustable by means of two levers in two directions.

Lever (A) is to adjust the position the pottrack fingers higher or lower.

Lever (B) is to adjust the position the width of the pot



The pottrack fingers should be adjusted as high as possible against the rim of the pot. Do not put the pottrack fingers tight against the pot, take a $\pm 3\text{mm}$ space on both sides.



Make sure the pottrack can be started; the pottrack has to rotate free of obstacles.

Procedure:

1. Adjust the height of the pottrack fingers with lever (A).
 - a. Pull the lever and pull / push the fingers of the pottrack to twist the pottrack fingers.
 - b. Counterclockwise: pottrack fingers are lowered.
 - c. Clockwise: pottrack fingers go up.
 - d. Adjust the track so that the pot is placed in the center of the pot support.
2. For optimal adjustment of the pottrack fingers:
 - a. Push the pottrack fingers as wide open as possible.
 - b. Adjust the fingers up (depending on pot size).
 - c. Adjust the track so that the pot is placed in the center of the pot support.
 - d. Lock the pot between the guide rail with $\pm 3\text{mm}$ space on both sides (important for centering the drill hole).
3. Then insert the pot into the holder and set the correct width using lever (B).
 - a. Pull the lever and pull / push one of the short fingers of the pottrack.
 - b. The pottrack fingers can now be adapted to the pot size.



The drill unit + brush + scraper should be in the highest position. Make sure the pottrack can be started; the pottrack must be able to rotate free of obstacles.

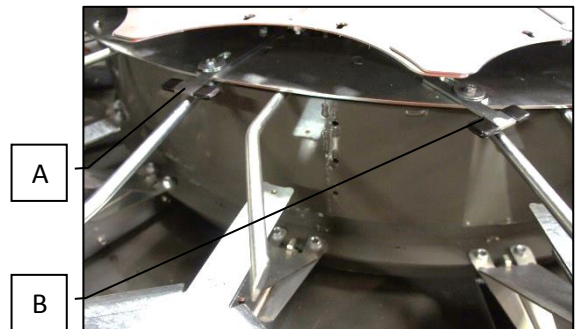

5.13 Set drill size



Set the drill size before you start working with the machine.

The drill size depends on the plug size of the plants.

Drill (B) is mounted in the drill shaft of the drill motor with two screws (A). The drill shaft screws have to be mounted to the flat side of the drill sleeve.

Drill plate (C) has a drill hole with a diameter of approximately 10 mm larger than the drill. This drill plate is to be mounted to the bottom side of rods (D) with 2 locknuts.

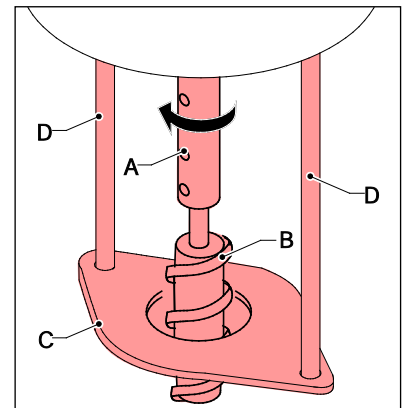

The depth of the hole depends on the position of the drill, which is adjustable. Adjust the depth by placing drill (B) in drill shaft (A).



Recommended distance of drill point under the drill plate is 1-2.cm.

Procedure height adjustment:

1. Loosen clamp (B).
2. Adjust drill height with swivel (C).
3. Tighten clamp (B).

Procedure side adjustment:

1. Loosen clamp (A).
2. Adjust drill in the lateral direction.



When clamp (A) is loosened then the drill can be adjusted in height. This should never happen. For height setting, follow the explanation described above.

3. Tighten clamp (A).

Procedure cross direction adjustment:

1. Loosen clamp (D).
2. The drill can be moved over the pottrack.
3. Tighten clamp (D).

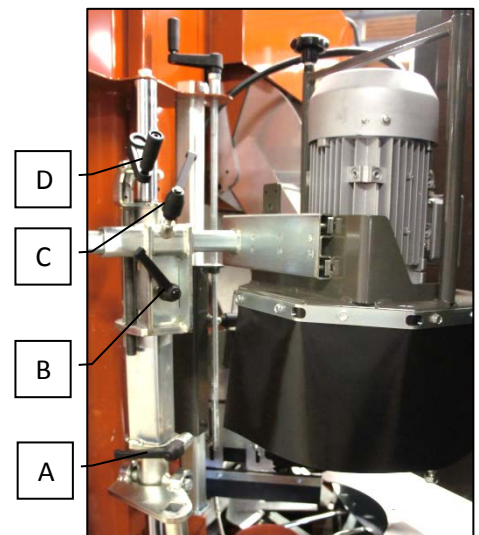

5.14 Set substrate valve



Set the substrate valve before you start working with the machine.

Substrate is rolled from the elevator to the substrate valve. The purpose of the valve is to control the substrate into the direction of the pots.

Procedure:

1. Loosen clamp (A).
2. Set the substrate valve.
 - a. Substrate valve can be pushed forwards and backwards.
3. Tighten clamp (A).

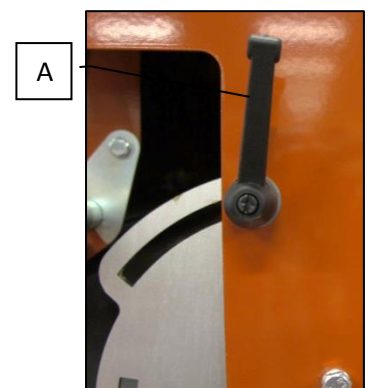

4. Two handles (B) are situated at the substrate valve. When lifting the handle it can shift in two directions, directing substrate in the correct direction.

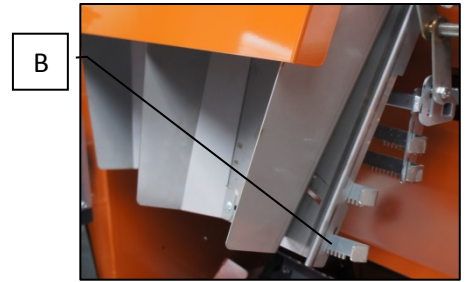

5.15 Moving the exit conveyor (optional)

The exit conveyor can be moved to all free positions on the pottrack (A). Follow the steps below.

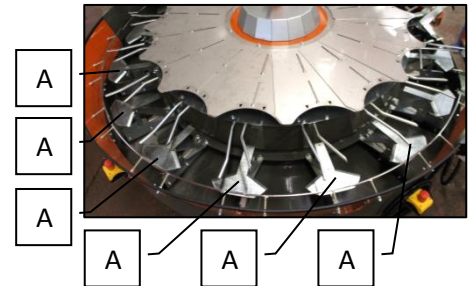

Procedure:

1. First, the conveyor belt has to be removed which has been placed onto support (B).
2. Dismantle two plates (C) by unscrewing the M8 bolts.
 - a. Leave the M8 bolts in the frame and lift the plates out.



3. Disassemble the end bracket (B) by loosening nut (D).
4. Remove the support.
5. Assemble the support at the place where the plates (C) have been removed.



6. Place the exit conveyor.
 - a. Loosen the two M8 bolts (G) (also leave these bolts in place).
7. Press plate (H) down and pull (I) backwards.
 - a. The pusher is detached from the frame.
 - b. The pusher is still attached to one point. This point is at the bottom of the pottrack.

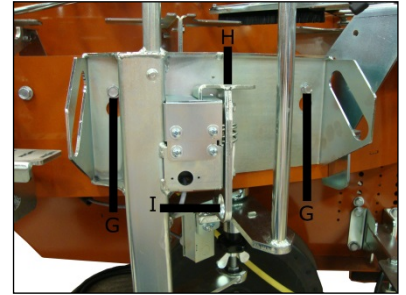

8. Loosen the pusher entirely by lifting rod (J) (where the plastic tip is mounted on) and slide it of the other rod.



9. Move the pusher to the place where the plate is removed.
10. Place the pusher over the two M8 bolts and make sure the plate where the spring is mounted in the frame of the pottrack clicks.



11. Tighten the M8 bolts and insert the rod (where the plastic tip is attached) to the bottom of the pottrack back into hole (K).
12. Insert the two plates (C) back in the former position of the exit conveyor.
13. Tighten four M8 bolts.

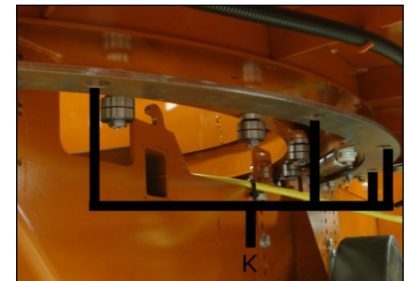

6 Operation



Follow all instructions described in this manual, in particular chapter safety.



Keep hands, hair, loose clothing and / or jewelry away from moving parts of the machine. Wear appropriate clothing without loose parts. Wear non-slip work shoes.



As long as the machine is on, no connection or safety devices may be removed. The machine may only be used when all protective devices and safety-related facilities are available and ready for use.



If a machine part is damaged or not working in the prescribed manner, work must be interrupted immediately. Resumption allowed only when the machine part is repaired or replaced and checked. Consult your dealer if the machine is not functioning properly.

6.1 Start

Start procedure:

1. Turn on the main power at the electrical cabinet (E).
 - a. Stop/ Error indication lamp will lit.
2. Turn on the drill, potttrack and elevator with switches (A+B+C) at the electrical cabinet.

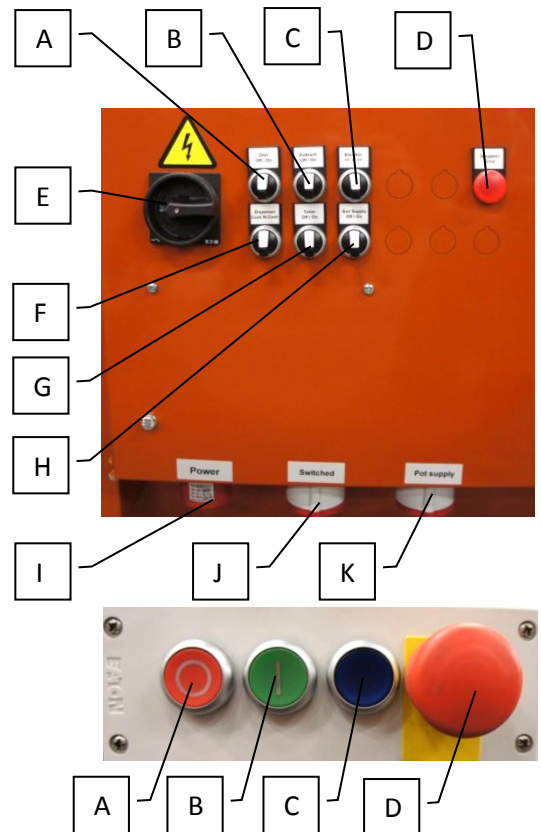

3. Press the blue reset button (C).
4. Press the green button (A) on the control panel to start the machine.

6.2 Stop

Stop procedure:

1. Press the red stop button (A) on the control panel.
 - a. Stop/ Error indication lamp will lit.

6.3 Emergency stop

Emergency stop procedure:

1. Press the red emergency stop button on the machine to activate the emergency stop.

Restart after emergency stop procedure:

1. Ensure that the cause of the emergency is resolved.
2. Close all doors and covers.
3. Pull the red emergency stop button to reset.
4. Press the reset button.
5. Press the green button on the control panel to start the machine.



7 Maintenance



Follow all instructions described in this manual, in particular chapter safety.



Maintenance of this machine must be performed in compliance with warnings on the machine and in accordance with the user manual by qualified personnel.



Keep hands, hair, loose clothing and / or jewelry away from moving parts of the machine. Wear appropriate clothing without loose parts. Wear non-slip work shoes.



As long as the machine is on, no connection or safety devices may be removed. The machine may only be used when all protective devices and safety-related facilities are available and ready for use.



Always unplug the plug from the socket before starting maintenance. Wear personal protective equipment (see section 2.3).



Inform operating personnel before start maintenance. Interrupt if possible the power (mains), before the machine is investigated or maintained by turning off the main switch and locking it and pull the plug from the socket. If work must be done with power supply (mains) voltage on the machine, work with an additional person who can operate the emergency stop.

7.1 Required tools and equipment

A set of keys is included with the machine, consisting of:

- A. Allan key 4 mm
- B. Door key
- C. Spanner 24-27mm
- D. Spanner 17-19mm
- E. Spanner 10-13mm

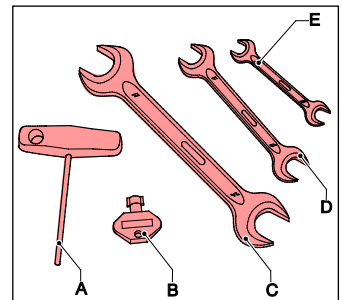

7.2 Preventive Maintenance

For the following maintenance instructions normal use is considered. With heavy use, or use under extreme conditions, maintenance should be performed at shorter intervals.

Item	1x per...	Comments
Machine	Day	After each daily use, spray with air to prevent pottrack jams etc. Common places where substrate is: the pottrack, drill, drive of the drill and the elevator.
Substrate bin	Day	Clear. See section "Empty substrate bin".
Elevator and belts	Day	Check tension. See section "Mounting, installation and commissioning".
Elevator blades	Day	Clean. See section "Elevator Blades Cleaning".
Materials in the machine	Day	Remove trays or other material that has fallen into the machine before starting the machine.
Drill unit	40 hours	Lubricate. see section "Lubricate drill unit".
Greaseras	6 months	Greaseras greasing: 2x elevator bearing, 3x driveshaft pottrack.
Gearbox	6 months	Check oil level (3/4 full is correct). Fill with HTX 320 oil. When in doubt or already HTX 320 oil in the gearbox; let all the oil out and fill it with HTX 320 oil.
Oil seal	6 months	Check on leakage.
Safety components	Week	Test the safety circuit. See section "Test safety circuit".

Item	1x per...	Comments
Pictograms	Week	Check readability and replace if necessary.
Electrical installation	Year	Check for damage.
Electric motors	Year	Remove dust.

7.3 Empty substrate bin

Procedure:

1. Turn off the machine and remove plug from socket.
2. Remove substrate out of the bin.
3. Clean the blades of the elevator.
4. Take of the cover (see photo).
5. Loosen the wing nut (see picture) and pull the substrate slide out.
6. Wipe substrate from under the machine.
7. Place the substrate slide back in place, tighten the wing nut and place the cover.



*Do not clean with water, but use compressed air and / or a brush.
Do not use sharp tools to prevent tire damage.*

7.4 Lubricate drill unit

The drilling unit must be lubricated in three places.

Procedure:

1. Lubricate grease fitting (A) after every 40 hours of use with a grease gun.
2. Spray the two sliding bars (B) after every 320 hours of operation with light oil.
 - a. The second sliding bar is located at the other side of the drilling unit.

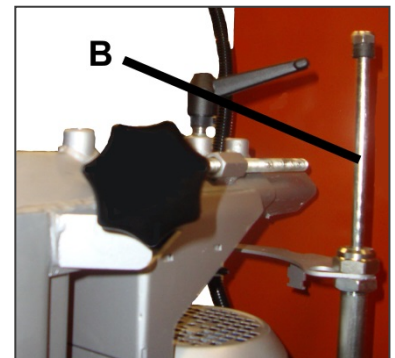

7.5 Elevator Blades Cleaning

Procedure:

1. Turn off the machine and remove plug from the socket.
2. Open the cover at the top with two wing nuts. The cover can be tilted towards the rear. Then the blades have to be cleaned with pressurized air.
 - a. The connection between the blade and the elevator belt has to be clean.



7.6 Test safety circuit

Procedure:

1. Start the machine.
2. Press the emergency stop button. The machine is now disabled.
3. Pull the Emergency Stop button. The machine remains off.
4. Press the reset button emergency stop circuit. All possibly connected conveyors start moving.
5. Start the machine



The machine must not be used when going through the above process, the machine responds differently than described above. Warn directly Javo BV.

7.7 Fault list

Problem	Possible cause	Action / Solution
Motor fault	mains voltage deviates more than 10% of the rated motor voltage	Provide the correct voltage
	Too high cooling air temperature	Provide cool air
	Poor cable connection	check the cable connection and repair if necessary
	Blown fuse	Replace fuse
	Too little cooling air caused by a clogged cooling air passage	Ensure proper inlet and outlet of the cooling air
	Frequency controller fault	Consult the frequency controller manual
The motor hums and takes too much power	Defect winding	Repair or replace the motor winding
	Loose wire	Lock wire
Fuses are blown or switches turned off	Short circuit in wiring or motor	Rectify the short circuit
	Mechanical blockage of pottrack, elevator or boron	Remove blockages
	Motor is connected incorrectly	Connect the motor correct
Drillmotor stops when drilling	Electrical problem with motor or cable	Call a qualified mechanic
Drillhole is too shallow	Adjustment not OK	Adjust the drill depth
Wreath badly or not height adjustable	Bearings worn	Replace worn ring bearings
Machine does not start	Door safety switch is open	Close door and reset the safety circuit by pressing the reset button
	Emergency stop button is not pulled	Pull Emergency Stop button and reset the safety circuit by pressing the reset button
	Emergency stop button not reset	Reset the safety circuit by pressing the reset button
	Breaker tripped in main cabinet	See why circuit breaker has tripped. Remove obstacles to conveyors. Switch on the machine after solving the problem.
	A second machine in line is not ready.	Clear second machine in line.
Pot separation unit fails	Cylinder is too slow for subsequent movement making machine completion steps are not completed. Valve is possible contaminated.	Replace the relevant valve.
2nd hand pots are not separated.	Pots too tight together.	Do not use 2nd hand pots.
Amount of soil provided is not enough	Soilslide is set too low.	Set the soil slide higher.
	Soilslide is set too low and a tunnel is build up above the soil conveyor.	Set the soil slide higher.
	belt slipping	Check conveyor tension
No soil provided	Elevator is stuck	Move elevator back and forwards and decrease the soil supply.

7.8 Adjust substrate conveyor to larger stroke

Procedure:

1. Remove protective cover (A).
 - a. Loosen the M8 bolts three turns.; The protective cover is removable.
2. Loosen with two wrenches (No. 19), bolt and nut (C).
3. Now, rod (B) can be adjusted.
 - a. Rod (B) can be adjusted onto two holes:
 - i. With hole (1) the stroke of substrate conveyor is the smallest.
 - ii. With hole (2) the stroke of substrate conveyor is the biggest.

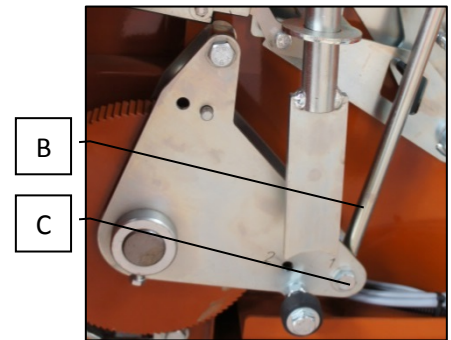
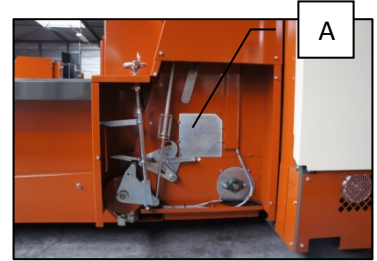

7.9 Drawings and schemes

The drawings accompanying this machine are supplied in a separate file. The wiring diagrams are included in the electrical cabinet of the machine.

7.10 Spare parts

Only original spare parts and accessories of Javo BV may be used on the machine.

Javo BV advises you to take certain parts in stock because of wear sensitivity and / or any expected downtime for re-ordering of the parts.

The spare parts list can be found on the assembly drawings. These can be found on JavoNet.

When ordering (spare) parts at Javo BV, the following information must be included: drawing number, item number, desired length (if applicable) and the desired number of pieces.

7.11 JavoNet

We recommend you to register your machine on JavoNet. This way you get online access to all technical drawings and documents pertaining to your machine.

Visit our website (www.javo.eu) for more information and to request an account.



7.12 Customer support and advice

Our technical department will answer your other questions about repair and maintenance of your machine and spare parts. We can help you with any questions regarding the purchase, use and settings of products and accessories.

8 Disposal of machine or machine parts



Follow all instructions described in this manual, in particular chapter safety.

Perform the following steps when disposing the machine:

1. Decommission the machine and remove electric and pneumatic power.
2. Drain and remove all consumables.
3. Scrap the machine according to the local legislation.

9 EG-conformity statement

EG-conformity statement for machines (directive 2006/42/EG, annex II, under A.)



Javo BV
 Westeinde 4
 2211XP Noordwijkerhout
 The Netherlands

Declares that:

Machine: *Plus M 2.0*
Type: *Potmachine*

is in accordance with the **Machine directive 2006/42/EG** and complies with the provisions of the **EMC-directive 2004/108/EEG**

Complies with the harmonized European Standards:

Harmonized European standard	definition	Harmonized European standard	definition
NEN-EN-ISO 12100:2010	Safety of machinery - Basic concepts, general principles for design - Part 1: Basic terminology, methodology	NPR-ISO/TR 14121-2:2010	Safety of machinery - Risk assessment - Part 2: Practical guidance and examples of methods
NEN-EN 953	Safety of machinery - Guards - General requirements for the design and construction of fixed and movable guards	NEN-EN 349	Safety of machinery - Minimum gaps to avoid crushing of parts of human body parts
NEN-EN-ISO 13857	Safety of machinery - Safety distances to prevent hazard zones being reached by the upper and lower limbs	NEN-EN 13850	Safety of machinery - Emergency stop - Principles for design
NEN-EN-ISO 13849-1	Safety of machinery - Parts of Control Systems with a safety function - Part 1: General principles for design	NEN-EN-IEC 60204-1	Safety of machinery - Electrical equipment of machines - Part 1: General requirements

The Netherlands, Noordwijkerhout,
 April 2014

Cees Bouwmeester
 Director