



Owners Manual

FOR POTABLE WATER HEATING ONLY
NOT SUITABLE FOR SPACE HEATING
NOT FOR USE IN MOBILE HOMES

Model No.

- 153.337114 50 Gal. Short High Altitude
- 153.337163 50 Gal. Short
- 153.337214 40 Gal. Short High Altitude
- 153.337263 40 Gal. Short
- 153.337363 30 Gal.
- 153.337414 40 Gal. High Altitude
- 153.337463 40 Gal.
- 153.337514 50 Gal. High Altitude
- 153.337563 50 Gal.
- 153.337614 65 Gal. High Altitude
- 153.337663 65 Gal.
- 153.337763 50 Gal. High Recovery
- 153.337863 65 Gal. High Recovery
- 153.337962 40 Gal. (L.P.)



Caution:
Read and Follow
All Safety Rules and
Operating Instructions
Before First Use of
This Product.

Save this Manual for Future Reference.

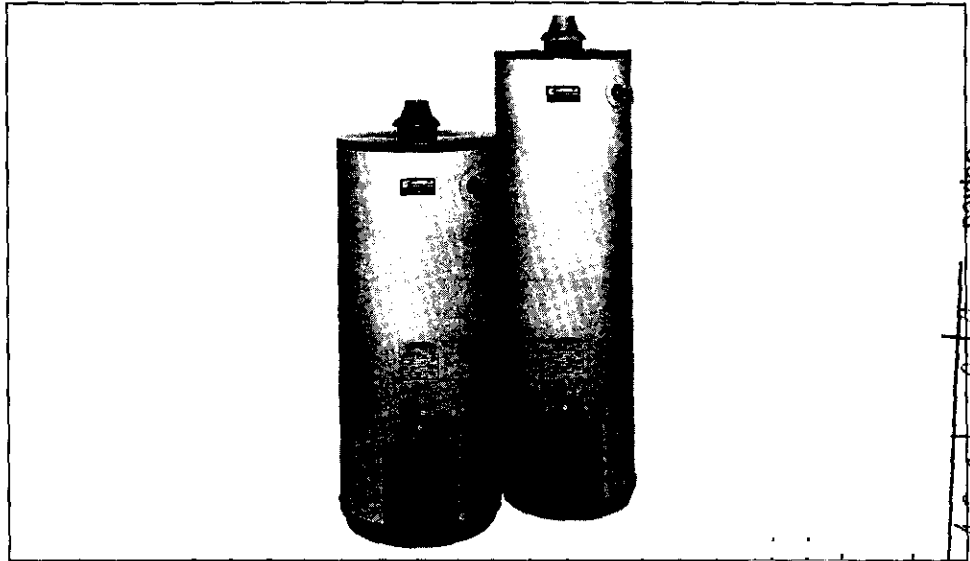

POWER MISER™ 9 GAS WATER HEATER

- Safety Instructions
- Installation
- Operation
- Care and Maintenance
- Troubleshooting
- Parts List

For Your Safety

AN ODORANT IS ADDED TO THE GAS USED BY THIS WATER HEATER

WARNING: If the information in these instructions are not followed exactly, a fire or explosion may result, causing property damage, personal injury or death.

- Do not store or use gasoline or other flammable vapors and liquids in the vicinity of this or any other appliance.
- WHAT TO DO IF YOU SMELL GAS**
 - Do not try to light any appliance.
 - Do not touch any electrical switch; do not use any phone in your building.
 - Immediately call your gas supplier from a neighbor's phone. Follow the gas supplier's instructions.
 - If you can not reach your gas supplier, call the fire department.
- Installation and service must be performed by a qualified installer, service agency or the gas supplier.

▲ WARNING

Improper installation, adjustment, alteration, service or maintenance can cause **DEATH, SERIOUS BODILY INJURY, OR PROPERTY DAMAGE.** Refer to this manual for assistance or consult the local Sears Service Center or gas utility for further information.

▲ WARNING

Flammable vapors may be drawn by air currents from other areas of the structure to this appliance.

▲ WARNING

READ THE GENERAL SAFETY SECTION BEGINNING ON INSIDE COVER AND THEN THIS ENTIRE MANUAL BEFORE INSTALLING OR OPERATING THIS WATER HEATER.

Safety Precautions

▲ WARNING

Improper installation, adjustment, alteration, service or maintenance can cause **DEATH, SERIOUS BODILY INJURY, OR PROPERTY DAMAGE**. Refer to this manual for assistance or consult your local Sears Service Center for further information.

▲ WARNING

WATER HEATERS EQUIPPED FOR ONE TYPE GAS ONLY: This water heater is equipped for one type gas only. Check the model rating plate near the gas control valve for the correct gas. **DO NOT USE THIS WATER HEATER WITH ANY GAS OTHER THAN THE ONE SHOWN ON THE MODEL RATING PLATE.** Failure to use the correct gas can cause problems which can result in **DEATH, SERIOUS BODILY INJURY, OR PROPERTY DAMAGE**. If you have any questions or doubts consult your gas supplier or local utility.

▲ WARNING

INSTALLATIONS IN AREAS WHERE FLAMMABLE LIQUIDS (VAPORS) ARE LIKELY TO BE PRESENT OR STORED (GARAGES, STORAGE, AND UTILITY AREAS, ETC): Flammable liquids (such as gasoline, solvents, propane (LP) or butane, etc.), all of which emit flammable vapors, may be improperly stored or used in such areas. The gas water heater pilot light or main burner can ignite such vapors. The resulting flashback and fire can cause death or serious burns to anyone in the area, as well as property damage.

If installation in such areas is your only option, then the installation must be accomplished in a way that the pilot flame and main burner flame are elevated from the floor at least 18 inches. While this may reduce the chances of flammable vapors from a floor spill being ignited, gasoline and other flammable substances should never be stored or used in the same room or area containing a gas water heater or other open flame or spark producing appliance. **NOTE:** Flammable vapors may be drawn by air currents from other areas of the structure to the appliance.

▲ WARNING

If this water heater will be used in beauty shops, barber shops, cleaning establishments, or self-service laundries with dry cleaning equipment, it is imperative that the water heater or water heaters be installed so that combustion and ventilation air be taken from outside these areas. Refer to the "Facts to Consider About the Location" section of this manual and also the latest edition of the National Fuel Gas Code, ANSI Z223.1, also referred to as NFPA 54 for specifics provided concerning air required.

▲ WARNING

A fire can start if combustible materials such as clothing, cleaning materials, or flammable liquids are placed against or next to the water heater.

▲ WARNING

At the time of manufacture this water heater was provided with a combination temperature-pressure relief valve certified by a nationally recognized testing laboratory that maintains periodic inspection of production of listed equipment or materials, as meeting the requirements for Relief Valves and Automatic Gas Shutoff Devices for Hot Water Supply Systems, and the latest edition of ANSI Z21.22 and the code requirements of ASME. If replaced, the valve must meet the requirements of local codes, but not less than a combination temperature and pressure relief valve certified as meeting the requirements for Relief Valves and Automatic Gas Shutoff Devices for Hot Water Supply Systems, ANSI Z21.22 by a nationally recognized testing laboratory that maintains periodic inspection of production of listed equipment or materials.

The valve must be marked with a maximum set pressure not to exceed the marked hydrostatic working pressure of the water heater (150 lbs./sq. in.) and a discharge capacity not less than the water heater input rate as shown on the model rating plate. (Electric heaters - watts divided by 1000 x 3415 equal BTU/Hr. rate.)

Your local jurisdictional authority, while mandating the use of a temperature-pressure relief valve complying with ANSI Z21.22 and ASME, may require a valve model different from the one furnished with the water heater.

Compliance with such local requirements must be satisfied by the installer or end user of the water heater with a locally prescribed temperature-pressure relief valve installed in the designated opening in the water heater in place of the factory furnished valve.

For safe operation of the water heater, the relief valve must not be removed from its designated opening or plugged.

The temperature-pressure relief valve must be installed directly into the fitting of the water heater designated for the relief valve. Position the valve downward and provide tubing so that any discharge will exit only within 6 inches above, or at any distance below the structural floor. Be certain that no contact is made with any live electrical part. The discharge opening must not be blocked or reduced in size under any circumstances. Excessive length, over 30 feet, or use of more than four elbows can cause restriction, and reduce the discharge capacity of the valve.

No valve or other obstruction is to be placed between the relief valve and the tank. Do not connect tubing directly to discharge drain unless a 6" air gap is provided.

To prevent bodily injury, hazard to life, or property damage, the relief valve must be allowed to discharge water in quantities should circumstances demand. If the discharge pipe is not connected to a drain or other suitable means, the water flow may cause property damage.

The Discharge Pipe:

- Must not be smaller in size than the outlet pipe size of the valve, or have any reducing couplings or other restrictions.
- Must not be plugged or blocked.
- Must be of material listed for hot water distribution.
- Must be installed so as to allow complete drainage of both the temperature-pressure relief valve, and the discharge pipe.
- Must terminate at an adequate drain.
- Must not have any valve between the relief valve and tank.

Safety Precautions

▲ WARNING

A gas water heater cannot operate properly without the correct amount of air for combustion. Do not install in a confined area such as a closet, unless you provide air as shown in the "Facts to Consider About the Location" section. Never obstruct the flow of ventilation air. If you have any doubts or questions at all, call your gas company. Failure to provide the proper amount of combustion air can result in a fire or explosion and can CAUSE DEATH, SERIOUS BODILY INJURY, OR PROPERTY DAMAGE.

▲ WARNING

HOTTER WATER CAN SCALD: Water heaters are intended to produce hot water. Water heated to a temperature which will satisfy clothes washing, dish washing, and other sanitizing needs can scald and permanently injure you upon contact. Some people are more likely to be permanently injured by hot water than others. These include the elderly, children, the infirm, or physically/mentally handicapped. If anyone using hot water in your home fits into one of these groups or if there is a local code or state law requiring a certain temperature water at the hot water tap, then you must take special precautions. In addition to using the lowest possible temperature setting that satisfies your hot water needs, a means such as a mixing valve, should be used at the hot water taps used by these people or at the water heater. Mixing valves are available at plumbing supply or hardware stores. Follow manufacturers instructions for installation of the valves. Before changing the factory setting on the thermostat, read the "Temperature Regulation" section in this manual.

▲ WARNING

Soot build-up indicates a problem that requires correction before further use. Turn "OFF" gas to water heater and leave "OFF" until repairs are made, because failure to correct the cause of the sooting can result in a fire or explosion causing DEATH, SERIOUS BODILY INJURY, OR PROPERTY DAMAGE.

▲ WARNING

BEFORE LIGHTING [PROPANE (L.P.) GAS WATER HEATERS]: Propane (L.P.) gas is heavier than air. Should there be a leak in the system, the gas will settle near the ground. Basements, crawl spaces, skirted areas under mobile homes (even when ventilated), closets and areas below ground level will serve as pockets for the accumulation of this gas. Before attempting to light or relight the water heater's pilot or turning on a nearby electrical light switch, be absolutely sure there is no accumulated gas in the area. Search for odor of gas by sniffing at ground level in the vicinity of the appliance. If odor is detected, follow steps indicated at "For Your Safety" on the cover page of this manual then leave the premises.

▲ WARNING

This water heater must not be installed directly on carpeting. Carpeting must be protected by a metal or wood panel beneath the appliance extending beyond the full width and depth of the appliance by at least 3 inches (76.2mm) in any direction, or if the appliance is installed in an alcove or closet, the entire floor must be covered by the panel. Failure to heed this warning may result in a fire hazard.

▲ WARNING

VENT DAMPERS - Any vent damper, whether it is operated thermally or otherwise must be removed if its use inhibits proper drafting of the water heater.
Thermally Operated Vent Dampers: Gas-fired water heaters having thermal efficiency in excess of 80% may produce a relatively low flue gas temperature. Such temperatures may not be high enough to properly open thermally operated vent dampers. This would cause spillage of flue gases and may cause carbon monoxide poisoning. Vent dampers must bear evidence of certification as complying with the latest edition of American National Standard ANSI Z21.68 (ANSI Z21.66 & 67, respectively, cover electrically and mechanically actuated vent dampers). Before installation of any vent damper, consult your local Sears Service Center or the gas utility for further information.

▲ WARNING

- The appliance and its individual shutoff valve must be disconnected from the gas supply piping system during any pressure testing of the gas system at test pressures in excess of 1/2 pound per square inch (3.5kPa).
- The appliance must be isolated from the gas supply piping system by closing its individual manual shutoff valve during any pressure testing of the gas supply piping system at test pressures equal or less than 1/2 pound per square inch (3.5kPa).

▲ WARNING

Chemical vapor corrosion of the flue and vent system may occur if air for combustion contains certain chemical vapors. Spray can propellants, cleaning solvents, refrigerator and air conditioner refrigerants, swimming pool chemicals, calcium and sodium chloride, waxes, bleach, and process chemicals are typical compounds which are potentially corrosive.

▲ WARNING

Obstructed or deteriorated vent systems may present a serious health risk or asphyxiation.

Safety Precautions continued on page 4.

Safety Precautions

▲ WARNING

The water heater with draft hood installed must be properly vented to a chimney which terminates outdoors. Never operate the water heater unless it is vented to the outdoors and has adequate air supply to avoid risks of improper operation, explosion or asphyxiation.

▲ WARNING

Minimum clearances between the water heater and combustible construction are 1" at the sides and rear, 4" at the front, and 6" from the vent pipe. Clearance from the top of the jacket is 18" on most models. Note that a lesser dimension may be allowed on some models. Refer to the label on the water heater adjacent to the gas control valve for all clearances.

▲ WARNING

Do not use this appliance if any part of it has been under water. Immediately call a Sears Service Technician to inspect the appliance and to replace the gas control or any part of the burner system which has been under water.

▲ WARNING

HYDROGEN GAS: Hydrogen gas can be produced in a hot water system that has not been used for a long period of time (generally two weeks or more). Hydrogen gas is extremely flammable and explosive. To prevent the possibility of injury under these conditions, we recommend the hot water faucet be opened for several minutes at the kitchen sink before any electrical appliances which are connected to the hot water system are used (such as a dishwasher or washing machine). If hydrogen gas is present, there will probably be an unusual sound similar to air escaping through the pipe as the hot water faucet is opened. There must be no smoking or open flame near the faucet at the time it is open.

▲ WARNING

INSULATING JACKETS: When installing an external water heater insulation jacket on a gas water heater:

- DO NOT cover the temperature-pressure relief valve.
- DO NOT put insulation over any part of the top of the gas water heater.
- DO NOT put insulation over the gas control valve or gas control valve/burner cover, or any access areas to the burner.
- DO NOT let insulation around the gas water heater to get within 8 inches of the floor (air must get to the burner).
- DO NOT cover or remove operating instructions, and safety related warning labels and materials affixed to the water heater.

Failure to heed this will result in the possibility of a fire or explosion.

▲ CAUTION

WATER HEATERS EVENTUALLY LEAK: Installation of the water heater must be accomplished in such a manner that if the tank or any connections should leak, the flow of water will not cause damage to the structure. For this reason, it is not advisable to install the water heater in an attic or upper floor. When such locations cannot be avoided, a suitable drain pan should be installed under the water heater. Drain pans are available at your local Sears store. Such a drain pan must be not greater than 1 1/2 inches deep, have a minimum length and width of at least 2 inches greater than the water heater dimensions and must be piped to an adequate drain. The pan must not restrict combustion air flow. Under no circumstances is the manufacturer or Sears to be held liable for any water damage in connection with this water heater.

Table of Contents

Safety Precautions.....	2-4
Table of Contents.....	5
Customer Responsibilities.....	6
Product Specifications.....	6
Materials and Basic Tools Needed.....	7
Materials Needed.....	7
Basic Tools.....	7
Installation Instructions.....	8-16
Removing the Old Water Heater.....	8
Facts to Consider About the Location.....	9
Combustion Air and Ventilation for Appliances in Unconfined Spaces.....	10
Combustion Air and Ventilation for Appliances in Confined Spaces.....	10
Water Piping.....	11
Temperature-Pressure Relief Valve.....	12
Filling the Water Heater.....	13
Venting.....	13-14
Gas Piping.....	14-15
Installation Checklist.....	16
Operating Instructions.....	17-19
Lighting.....	17-18
Temperature Regulation.....	19
Service and Adjustment.....	20-22
Tank (Sediment) Cleaning.....	20
Venting System Inspection.....	20
Burner Inspection.....	20
Burner Cleaning.....	20
L.P. Gas Control Valve & Burner Assembly Replacement Information.....	21
Draining.....	21
Temperature-Pressure Relief Valve Operation.....	21
Drain Valve Washer Replacement.....	22
Housekeeping.....	22
Service.....	22
Troubleshooting Guide.....	23-25
Start Up Conditions.....	23
Condensation.....	23
Smoke/Odor.....	23
Thermal Expansion.....	23
Strange Sounds.....	23
Operational Conditions.....	24
Smelly Water.....	24
Air in Hot Water Faucets.....	24
High Temperature Shut Off System.....	24
Not Enough or No Hot Water.....	24
Water is too Hot.....	24
Leakage Checkpoints.....	25
Parts Order List.....	28-35

Customer Responsibilities

Thank You for purchasing a Sears water heater. Properly installed and maintained, it should give you years of trouble free service. If you should decide that you want the new water heater professionally installed by Sears call the local Sears Service Center or any Sears store. They will arrange for prompt, quality installation by Sears authorized contractors.

Abbreviations Found In This Instruction Manual

CSA - Canadian Standards Association
ANSI - American National Standards Institute
NFPA - National Fire Prevention Association

▲ WARNING

This gas-fired water heater is design certified by CSA INTERNATIONAL under American National Standard/CSA Standard for Gas Water Heaters ANS Z21.10.1 • CSA 4.1 (latest edition). The installation must conform with this manual, Local Codes and with the latest edition of the National Fuel Gas Code, ANSI Z223.1.

This publication is available from your local government or public library, gas company, or by writing NFPA, Batterymarch Park, Quincy, MA 02269.

- Read the "Safety Precautions" section, pages 2 through 4 of this manual first and then the entire manual carefully. If you don't follow the safety rules, the water heater will not operate properly. It could cause DEATH, SERIOUS BODILY INJURY AND/OR PROPERTY DAMAGE.

This manual contains instructions for the installation, operation, and maintenance of the gas-fired water heater. It also contains warnings through out the manual that you must read and be aware of. All warnings and all instructions are essential to the proper operation of the water heater and your safety. Since we cannot put everything on the first few pages, **READ THE ENTIRE MANUAL BEFORE ATTEMPTING TO INSTALL OR OPERATE THE WATER HEATER.**

- The installation must conform with the instructions in this manual; gas company rules; and Local Codes, or in the absence of Local Codes, with the latest edition of the National Fuel Gas code, ANSI Z223.1, also referred to as NFPA 54. This publication is available from your local government or public library or gas company or by writing NFPA, Batterymarch Park, Quincy, MA 02269.
- If after reading this manual you have any questions or do not understand any portion of the instructions, call the Sears Service Center.
- Carefully plan the place where you are going to put the water heater. Correct combustion, vent action, and vent pipe installation are very important in preventing death from possible carbon monoxide poisoning and fires. Examine the location to ensure the water heater complies with the "Facts to Consider About the Location" section in this manual.
- For California installation this water heater must be braced, anchored, or strapped to avoid falling or moving during an earthquake. See instructions for correct installation procedures. Instructions may be obtained from your local dealer, wholesaler, public utilities or California Office of the State Architect, 400 P Street, Sacramento, CA 95814.
- Complies with SCAQMD rule #1121 and districts having equivalent NOx requirements.

Product Specifications

MODEL NUMBER	TANK CAPACITY IN GALLONS	TYPE OF GAS	B.T.U. RATE	RECOVERY RATE GAL.S. PER HOUR @ 90°F RISE	MINIMUM VENT PIPE	DIMENSIONS IN INCHES	
						DIAMETER	HEIGHT TO JACKET TOP
153.337114	50	NATURAL	40,000	40.9	3" or 4"	22"	49"
153.337163	50	NATURAL	40,000	40.9	3" or 4"	22"	49"
153.337214	40	NATURAL	40,000	40.9	3" or 4"	20"	47½"
153.337263	40	NATURAL	40,000	40.9	3" or 4"	20"	47½"
153.337363	30	NATURAL	40,000	40.9	3" or 4"	16"	57½"
153.337414	40	NATURAL	40,000	40.9	3" or 4"	18"	58¼"
153.337463	40	NATURAL	40,000	40.9	3" or 4"	18"	58¼"
153.337514	50	NATURAL	40,000	40.9	3" or 4"	20"	58"
153.337563	50	NATURAL	40,000	40.9	3" or 4"	20"	58"
153.337614	65	NATURAL	40,000	40.9	3" or 4"	22"	59½"
153.337663	65	NATURAL	40,000	40.9	3" or 4"	22"	59½"
153.337763	50	NATURAL	52,500	53.7	4"	20"	58¼"
153.337863	65	NATURAL	50,000	51.2	4"	22"	59½"
153.337962	40	PROPANE	40,000	40.9	3" or 4"	18"	58¼"

Materials and Basic Tools Needed

Materials Needed

To simplify the installation Sears has available the installation parts shown below. You may or may not need all of these materials, depending on your type of installation.

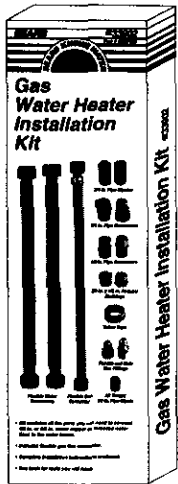

WATER HEATER INSTALLATION KIT WITH FLEXIBLE CONNECTORS FOR 3/4" OR 1/2" THREADED OR COPPER PLUMBING



WATER HEATER HEAT TRAPS HELP REDUCE HEAT LOSS DUE TO THERMAL SYPHONING

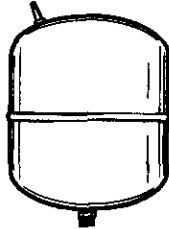

EXPANSION TANKS FOR THERMAL EXPANSION CONDITIONS AVAILABLE IN 2 GALLON AND 5 GALLON CAPACITY THROUGH LOCAL SEARS STORE OR SERVICE CENTERS

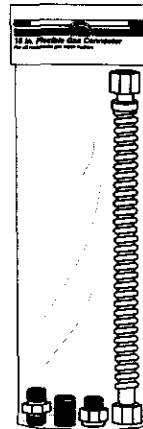

FLEXIBLE WATER HEATER GAS CONNECTOR WITH FITTINGS

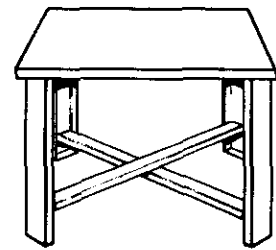

WATER HEATER STAND 24"x24"x18" FOR USE WITH WATER HEATERS INSTALLED IN RESIDENTIAL GARAGES HAVING A DIAMETER 24" OR LESS AND A RATED CAPACITY 75 GALLONS OR LESS



VENT ELBOW



VENT PIPE

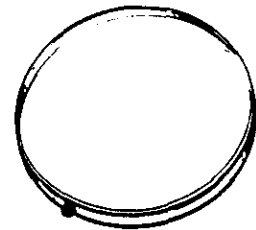

DRAIN PANS AVAILABLE IN 20" DIAMETER FOR WATER HEATERS HAVING A DIAMETER 18" OR LESS, 24" DIAMETER FOR WATER HEATERS HAVING A DIAMETER 22" OR LESS AND AVAILABLE IN 28" DIAMETER FOR WATER HEATERS HAVING A DIAMETER 26" OR LESS

Basic Tools

You may or may not need all of these tools, depending on your type of installation. These tools can be purchased at your local Sears store.

- Pipe Wrenches (2) 14"
- Screwdriver
- Tin Snips
- 6 Foot Tape of Folding Rule
- Garden Hose
- Drill
- Pipe dope or Teflon Tape



GARDEN HOSE



6 FOOT TAPE



PIPE WRENCH

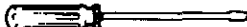

SLOT-HEAD SCREWDRIVER



PHILLIPS SCREWDRIVER

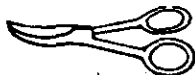

TIN SNIPS



ROLL OF TEFLON TAPE (USE ONLY ON WATER CONNECTIONS)

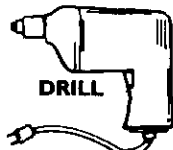

DRILL



PIPE DOPE (SQUEEZE TUBE) (USE FOR WATER AND GAS CONNECTIONS)

ADDITIONAL TOOLS NEEDED WHEN SWEAT SOLDERING

- Tubing Cutters or Hacksaw
- Propane Torch
- Soft Solder
- Solder Flux
- Emery Cloth
- Wire Brushes

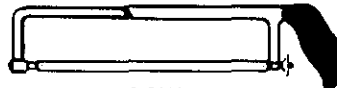

HACKSAW



3/4" WIRE BRUSH



1/2" WIRE BRUSH



ROLL OF LEAD FREE SOFT SOLDER



PROPANE TORCH



ROLL OF EMERY CLOTH



SOLDER FLUX



TUBING CUTTER

Installation Instructions

Removing the Old Water Heater

- 1 Turn "OFF" the gas supply to the water heater.

▲ WARNING

If the main gas line shutoff serving all gas appliances is used, also shut "off" the gas at each appliance. Leave all gas appliances shut "off" until the water heater installation is complete.

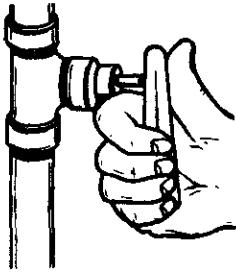

- 2 Turn "OFF" the water to the water heater. Some installations require that the water be turned off to the entire house.



- 3 Check again to make sure the gas supply is "OFF" to the water heater. Then disconnect the gas supply connection from the gas control valve.

- 4 Attach a hose to the water heater drain valve and put the other end in a floor drain or outdoors. Open the water heater drain valve. Open a nearby hot water faucet which will relieve pressure in the water heater and speed draining.

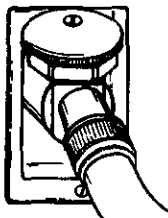

▲ WARNING

The water passing out of the drain valve may be extremely hot. To avoid being scalded, make sure all connections are tight and that the water flow is directed away from any person.

- 5 Disconnect the vent pipe from the draft hood where they connect to the water heater. In most installations the vent pipe can be lifted off after any screw or other attached devices are removed. Dispose of the draft hood. The new water heater has the draft hood which must be used for proper operation.

- 6 a. If you have copper piping to the water heater, the two copper water pipes can be cut with a hacksaw approximately four inches away from where they connect to the water heater. This will avoid cutting off the pipes too short. Additional cuts can be made later if necessary. Disconnect the temperature-pressure relief valve drain line. When the water heater is drained, disconnect the hose from the drain valve. Close the drain valve. The water heater is now completely disconnected and ready to be removed.

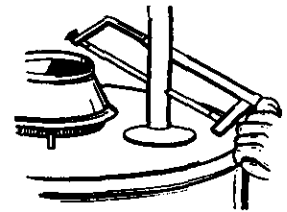

- 6 b. If you have galvanized pipe to the water heater, loosen the two galvanized pipes with a pipe wrench at the union in each line. Also disconnect the piping remaining to the water heater. These pieces should be saved since they may be needed when reconnecting the new water heater. Disconnect the temperature-pressure relief valve drain line. When the water heater is drained, disconnect the hose from the drain valve. Close the drain valve. The water heater is now completely disconnected and ready to be removed.

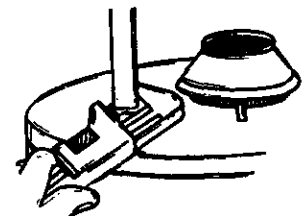

▲ CAUTION

Mineral buildup or sediment may have accumulated in the old water heater. This causes the water heater to be much heavier than normal and this residue, if spilled out, could cause staining.

Installation Instructions (cont'd)

Facts to Consider About the Location

You should carefully choose an indoor location for the new water heater, because the placement is a very important consideration for the safety of the occupants in the building and for the most economical use of the appliance. **This water heater is not for use in mobile homes or outdoor installation.**

Whether replacing an old water heater or putting the water heater in a new location, the following critical points must be observed.

- The location selected should be indoors as close as practical to the gas vent or chimney to which the water heater vent is going to be connected, and as centralized with the water piping system as possible. The water heater, as all water heaters, will eventually leak. Do not install without adequate drainage provisions where water flow will cause damage.

▲ CAUTION

WATER HEATERS EVENTUALLY LEAK: Installation of the water heater must be accomplished in such a manner that if the tank or any connections should leak, the flow of water will not cause damage to the structure. For this reason, it is not advisable to install the water heater in an attic or upper floor. When such locations cannot be avoided, a suitable drain pan should be installed under the water heater. Drain pans are available at your local Sears store. Such a drain pan must be not greater than 1½ inches deep, have a minimum length and width of at least 2 inches greater than the water heater dimensions and must be piped to an adequate drain. The pan must not restrict combustion air flow. Under no circumstances is the manufacturer or Sears to be held liable for any water damage in connection with this water heater.

▲ WARNING

INSTALLATIONS IN AREAS WHERE FLAMMABLE LIQUIDS (VAPORS) ARE LIKELY TO BE PRESENT OR STORED (GARAGES, STORAGE, AND UTILITY AREAS, ETC): Flammable liquids (such as gasoline, solvents, propane (LP) or butane, etc.), all of which emit flammable vapors, may be improperly stored or used in such areas. The gas water heater pilot light or main burner can ignite such vapors. The resulting flashback and fire can cause death or serious burns to anyone in the area, as well as property damage.

If installation in such areas is your only option, then the installation must be accomplished in a way that the pilot flame and main burner flame are elevated from the floor at least 18 inches. While this may reduce the chances of flammable vapors from a floor spill being ignited, gasoline and other flammable substances should never be stored or used in the same room or area containing a gas water heater or other open flame or spark producing appliance.

NOTE: Flammable vapors may be drawn by air currents from other areas of the structure to the appliance.

▲ WARNING

Propellants of aerosol sprays and volatile compounds, (cleaners, chlorine based chemicals, refrigerants, etc.) in addition to being highly flammable in many cases, will also change to corrosive hydrochloric acid when exposed to the combustion products of the water heater. The results can be hazardous, and also cause product failure.

- The location selection must provide adequate clearances for servicing and proper operation of the water heater.

▲ WARNING

This water heater must not be installed directly on carpeting. Carpeting must be protected by a metal or wood panel beneath the appliance extending beyond the full width and depth of the appliance by at least 3 inches (76.2mm) in any direction, or if the appliance is installed in an alcove or closet, the entire floor must be covered by the panel. Failure to heed this warning may result in a fire hazard.

▲ WARNING

Minimum clearances between the water heater and combustible construction are 1" at the sides and rear, 4" at the front, and 6" from the vent pipe. Clearance from the top of the jacket is 18" on most models. Note that a lesser dimension may be allowed on some models. Refer to the label on the water heater adjacent to the gas control valve for all clearances.

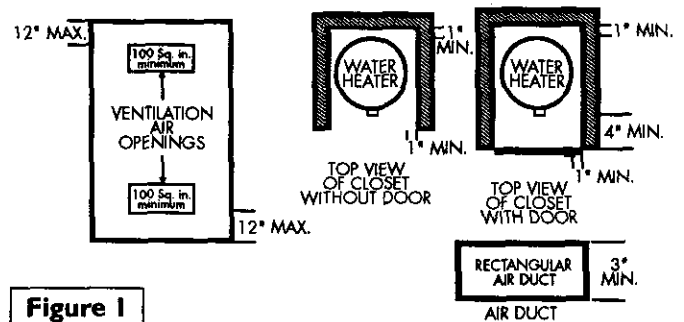

Figure 1

▲ WARNING

A gas water heater cannot operate properly without the correct amount of air for combustion. Do not install in a confined area such a closet, unless you provide air as shown in Figures 1-5. Never obstruct the flow of ventilation air. If you have any doubts or questions at all, call your gas company. Failure to provide the proper amount of combustion air can result in a fire or explosion and can cause DEATH, SERIOUS BODILY INJURY, OR PROPERTY DAMAGE.

▲ WARNING

If this water heater will be used in beauty shops, barber shops, cleaning establishments, or self-service laundries with dry cleaning equipment, it is imperative that the water heater or water heaters be installed so that combustion and ventilation air be taken from outside these areas. Refer to the "Facts to Consider About the Location" section of this manual and also the latest edition of the National Fuel Gas Code, ANSI Z223.1, also referred to as NFPA 54 for specifics provided concerning air required.

Installation Instructions (cont'd)

Combustion Air and Ventilation for Appliances Located in Unconfined Spaces

Unconfined Space is a space whose volume is not less than 50 cubic feet per 1,000 Btu per hour of the aggregate input rating of all appliances installed in that space. Rooms communicating directly with the space in which the appliances are installed, through openings not furnished with doors, are considered a part of the unconfined space.

In unconfined spaces in buildings, infiltration may be adequate to provide air for combustion, ventilation and dilution of flue gases. However, in buildings of tight construction (for example, weather stripping, heavily insulated, caulked, vapor barrier, etc.), additional air may need to be provided using the methods described in Combustion Air and Ventilation for Appliances Located in Confined Spaces, b.

Combustion Air and Ventilation for Appliances Located in Confined Spaces

Confined Space is a space whose volume is less than 50 cubic feet per 1,000 Btu per hour of the aggregate input rating of all appliances installed in that space.

a. ALL AIR FROM INSIDE BUILDINGS:

(See Page 9 Figure 1, and Figure 2 below)

The confined space shall be provided with two permanent openings communicating directly with an additional room(s) of sufficient volume so that the combined volume of all spaces meets the criteria for an unconfined space. The total input of all gas utilization equipment installed in the combined space shall be considered in making this determination. Each opening shall have a minimum free area of one square inch per 1,000 BTU per hour of the total input rating of all gas utilization equipment in the confined space, but not less than 100 square inches. One opening shall commence within 12 inches of the top and one commencing within 12 inches of the bottom of the enclosure.

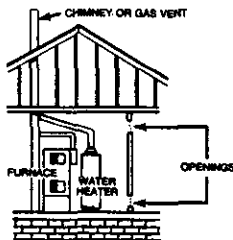

Figure 2

b. ALL AIR FROM OUTDOORS: (see Figures 3-5)

The confined space shall be provided with two permanent openings, one commencing within 12 inches of the top and one commencing within 12 inches from the bottom of the enclosure. The openings shall communicate directly, or by ducts, with the outdoors or spaces (crawl or attic) that freely communicate with the outdoors.

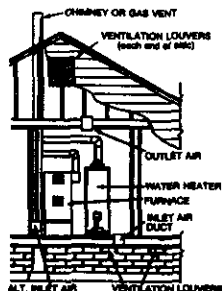

Figure 3

1. When directly communicating with the outdoors, each opening shall have a minimum free area of 1 square inch per 4,000 BTU per hour of total input rating of all equipment in the enclosure. (See Figure 3.)
2. When communicating with the outdoors through vertical ducts, each opening shall have a minimum free area of 1 square inch per 4,000 BTU per hour of total input rating of all equipment in the enclosure. (See Figure 4.)

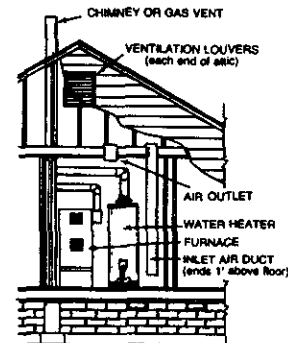

Figure 4

3. When communicating with the outdoors through horizontal ducts, each opening shall have a minimum free area of 1 square inch per 2,000 BTU per hour of total input rating of all equipment in the enclosure. (See Figure 5.)

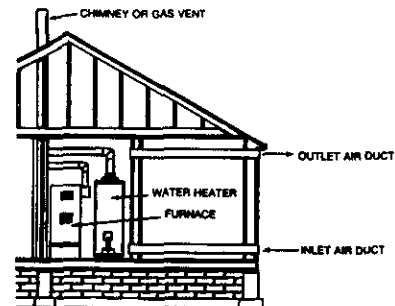

Figure 5

4. When ducts are used, they shall be of the same cross-sectional area as the free area of the openings to which they connect. The minimum short side dimension of rectangular air ducts shall not be less than 3 inches. (See Figure 5.)
5. Louvers and Grilles: In calculating free area, consideration shall be given to the blocking effect of louvers, grilles or screens protecting openings. Screens used shall not be smaller than 1/4 inch mesh. If the free area through a design of louver or grille is known, it should be used in calculating the size opening required to provide the free area specified. If the design and free area is not known, it may be assumed that wood louvers will be 20-25 percent free area and metal louvers and grilles will have 60-75 percent free area. Louvers and grilles shall be fixed in the open position or interlocked with the equipment so that they are opened automatically during equipment operation.
6. Special Conditions Created by Mechanical Exhausting or Fireplaces: Operation of exhaust fans, ventilation systems, clothes dryers or fireplaces may create conditions requiring special attention to avoid unsatisfactory operation of installed gas utilization equipment.

Installation Instructions (cont'd)

Water Piping

▲ WARNING

HOTTER WATER CAN SCALD: Water heaters are intended to produce hot water. Water heated to a temperature which will satisfy clothes washing, dish washing, and other sanitizing needs can scald and permanently injure you upon contact. Some people are more likely to be permanently injured by hot water than others. These include the elderly, children, the infirm, or physically/mentally handicapped. If anyone using hot water in your home fits into one of these groups or if there is a local code or state law requiring a certain temperature water at the hot water tap, then you must take special precautions. In addition to using the lowest possible temperature setting that satisfies your hot water needs, a means such as a mixing valve, should be used at the hot water taps used by these people or at the water heater. Mixing valves are available at plumbing supply or hardware stores. Follow manufacturers instructions for installation of the valves. Before changing the factory setting on the thermostat, read the "Temperature Regulation" section in this manual.

This water heater shall not be connected to any heating systems or component(s) used with a non-potable water heating appliance.

If a water heater is installed in a closed water supply system; such as one having a back-flow preventer, check valve, water meter with a check valve, etc... in the cold water supply; means shall be provided to control thermal expansion. Contact the local utility or local Sears Service Center on how to control this situation.

NOTE: To protect against untimely corrosion of hot and cold water fittings, it is strongly recommended that di-electric unions or couplings be installed on this water heater when connected to copper pipe.

The illustration shows the attachment of the water piping to the water heater. The water heater is equipped with 3/4 inch water connections.

NOTE: If using copper tubing, solder tubing to an adapter before attaching the adapter to the cold water inlet connection. Do not solder the cold water supply line directly to the cold water inlet. It will harm the dip tube and damage the tank.

- Look at the top cover of the water heater. The water outlet is marked hot. Put two or three turns of teflon tape around the threaded end of the threaded-to-sweat coupling and around both ends of the 3/4" threaded nipple. Using flexible connectors, connect the hot water pipe to the hot water outlet on the water heater.

- Look at the top cover of the water heater. The cold water inlet is marked cold. Put two or three turns of teflon tape around the threaded end of the threaded-to-sweat coupling and around both ends of the 3/4" threaded nipple. Using flexible connectors, connect the cold water pipe to the cold water inlet of the water heater.

NOTE: This water heater is super insulated to minimize heat loss from the tank. Further reduction in heat loss can be accomplished by insulating the hot water lines from the water heater.

INSTALLATION COMPLETED USING SEARS INSTALLATION KIT

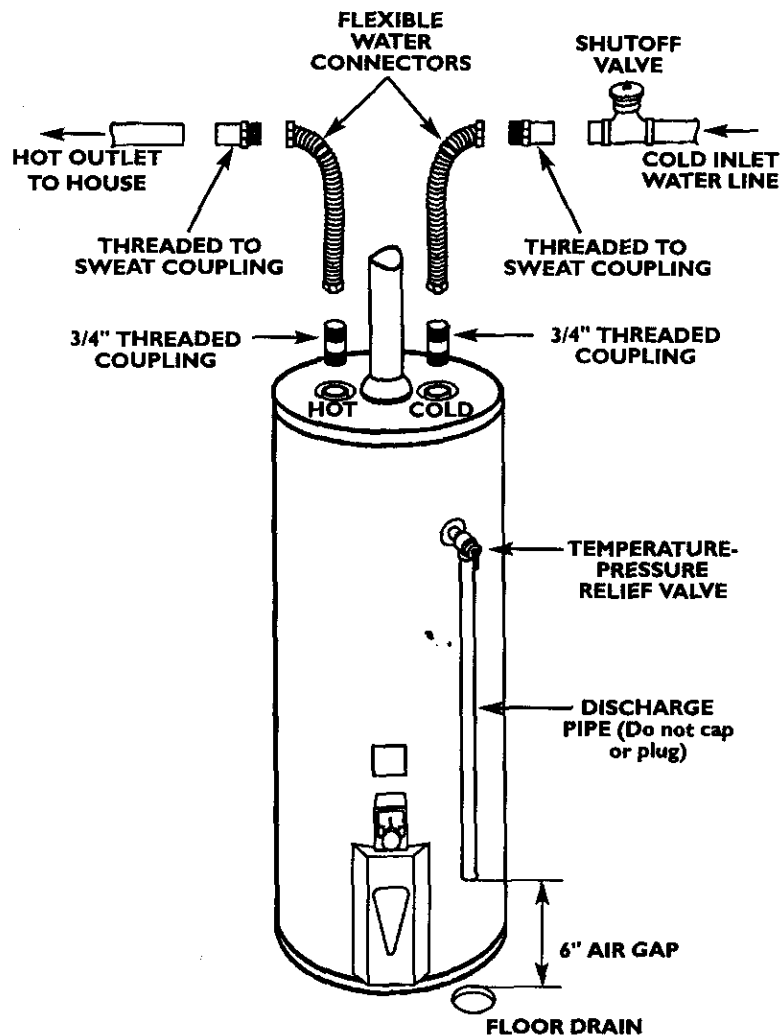

Installation Instructions (cont'd)

Temperature-Pressure Relief Valve

▲ WARNING

At the time of manufacture this water heater was provided with a combination temperature-pressure relief valve certified by a nationally recognized testing laboratory that maintains periodic inspection of production of listed equipment or materials, as meeting the requirements for Relief Valves and Automatic Gas Shutoff Devices for Hot Water Supply Systems, and the latest edition of ANSI Z21.22 and the code requirements of ASME. If replaced, the valve must meet the requirements of local codes, but not less than a combination temperature and pressure relief valve certified as meeting the requirements for Relief Valves and Automatic Gas Shutoff Devices for Hot Water Supply Systems, ANSI Z21.22 by a nationally recognized testing laboratory that maintains periodic inspection of production of listed equipment or materials.

The valve must be marked with a maximum set pressure not to exceed the marked hydrostatic working pressure of the water heater (150 lbs./sq. in.) and a discharge capacity not less than the water heater input rate as shown on the model rating plate. (Electric heaters - watts divided by 1000 x 3415 equal BTU/Hr. rate.)

Your local jurisdictional authority, while mandating the use of a temperature-pressure relief valve complying with ANSI Z21.22 and ASME, may require a valve model different from the one furnished with the water heater.

Compliance with such local requirements must be satisfied by the installer or end user of the water heater with a locally prescribed temperature-pressure relief valve installed in the designated opening in the water heater in place of the factory furnished valve.

For safe operation of the water heater, the relief valve must not be removed from its designated opening or plugged.

The temperature-pressure relief valve must be installed directly into the fitting of the water heater designated for the relief valve. Position the valve downward and provide tubing so that any discharge will exit only within 6 inches above, or at any distance below the structural floor. Be certain that no contact is made with any live electrical part. The discharge opening must not be blocked or reduced in size under any circumstances. Excessive length, over 30 feet, or use of more than four elbows can cause restriction and reduce the discharge capacity of the valve.

No valve or other obstruction is to be placed between the relief valve and the tank. Do not connect tubing directly to discharge drain unless a 6" air gap is provided. To prevent bodily injury, hazard to life, or property damage, the relief valve must be allowed to discharge water in quantities should circumstances demand. If the discharge pipe is not connected to a drain or other suitable means, the water flow may cause property damage.

The Discharge Pipe:

- Must not be smaller in size than the outlet pipe size of the valve, or have any reducing couplings or other restrictions.
- Must not be plugged or blocked.
- Must be of material listed for hot water distribution.
- Must be installed so as to allow complete drainage of both the temperature-pressure relief valve, and the discharge pipe.
- Must terminate at an adequate drain.
- Must not have any valve between the relief valve and tank.

▲ WARNING

The temperature-pressure relief valve must be manually operated at least once a year. Caution should be taken to ensure that (1) no one is in front of or around the outlet of the temperature-pressure relief valve discharge line, and (2) the water manually discharged will not cause any bodily injury or property damage because the water may be extremely hot.

If after manually operating the valve, it fails to completely reset and continues to release water, immediately close the cold water inlet to the water heater, follow the draining instructions, and replace the temperature-pressure relief valve with a new one.

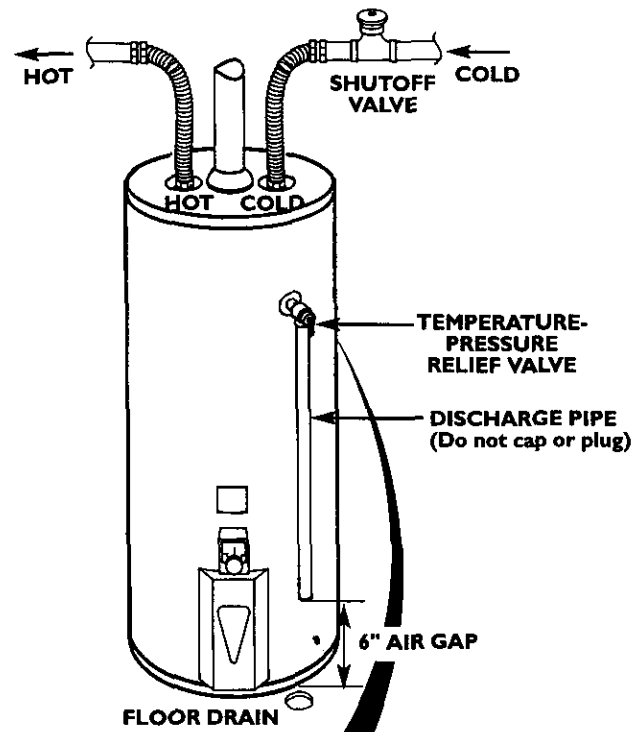

RELIEF VALVE OPENING

At the time of manufacture, this water heater was provided with a combination temperature-pressure relief valve listed as complying with the standard for relief valves and automatic gas shut-off devices for hot water supply systems, ANSI Z21.22. For safe operation of the water heater, the relief valve must not be removed from its designated point of installation or plugged.

Your local jurisdictional authority, while mandating the use of a temperature-pressure relief valve complying with ANSI Z21.22 and ASME, may require a valve model different from the one furnished with the water heater.

Compliance with such local requirements must be satisfied by the installer or end user of the water heater with a locally prescribed temperature-pressure relief valve installed in the designated opening in the water heater.

See manual heading - "Temperature-Pressure Relief Valves" for installation and maintenance of relief valve, discharge line, and other safety precautions.

Installation Instructions (cont'd)

Filling the Water Heater

▲ CAUTION

Never use this water heater unless it is completely filled with water. To prevent damage to the tank, the tank must be filled with water. Water must flow from the hot water faucet before turning "ON" gas to the water heater.

To fill the water heater with water:

- Close the water heater drain valve by turning the handle to the right (clockwise). The drain valve is on the lower front of the water heater.
- Open the cold water supply valve to the water heater.
NOTE: The cold water supply valve must be left open when the water heater is in use.
- To insure complete filling of the tank, allow air to exit by opening the nearest hot water faucet. Allow water to run until a constant flow is obtained. This will let air out of the water heater and the piping.
- Check all new water piping for leaks. Repair as needed.

Venting

▲ WARNING

VENT DAMPERS - Any vent damper, whether it is operated thermally or otherwise must be removed if its use inhibits proper drafting of the water heater.

Thermally Operated Vent Dampers: Gas-fired water heaters having thermal efficiency in excess of 80% may produce a relatively low flue gas temperature. Such temperatures may not be high enough to properly open thermally operated vent dampers. This would cause spillage of flue gases and may cause carbon monoxide poisoning.

Vent dampers must bear evidence of certification as complying with the latest edition of American National Standard ANSI Z21.68 (ANSI Z21.66 & 67, respectively, cover electrically and mechanically actuated vent dampers). Before installation of any vent damper, consult your local Sears Service Center or the gas utility for further information.

▲ WARNING

To insure proper venting of this gas-fired water heater, the correct vent pipe diameter must be utilized. Any additions or deletions of other gas appliances on a common vent with this water heater may adversely affect the operation of the water heater. Consult the local Sears Service Center or gas utility if any such changes are planned.

For proper venting in certain installations, a larger diameter vent pipe may be necessary. Due to great variances in installations, unforeseeable by the manufacturer of the water heater, you must consult your gas company to aid you in determining the proper venting for your water heater from the vent tables in the latest edition of the National Fuel Gas Code ANSI Z223.1, also referred to as NFPA 54.

Check the venting system for signs of obstruction or deterioration and replace if needed.

The combustion and ventilation air flow must not be obstructed.

▲ WARNING

Obstructed or deteriorated vent systems may present a serious health risk or asphyxiation.

- Place the draft hood legs in the receiving holes on the top of the water heater. The legs will snap in the holes to give a tight fit.
- Place the vent pipe over the draft hood. With the vent pipe in position, drill a small hole through both the vent pipe and draft hood. Secure them together with a sheet metal screw.

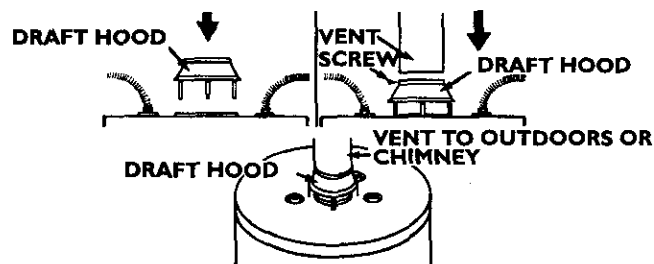

▲ WARNING

The water heater with draft hood installed must be properly vented to a chimney which terminates outdoors. Never operate the water heater unless it is vented to the outdoors and has adequate air supply to avoid risks of improper operation, explosion or asphyxiation.

▲ WARNING

The vent pipe from the water heater must be no less than the diameter of the draft hood outlet on the water heater, and must slope upward to the chimney at least 1/4 inch per linear foot.

Installation Instructions (cont'd)

Venting (cont'd)

All vent gases must be completely vented to the outdoors of the structure (dwelling). Install only the draft hood provided with the new water heater and no other draft hood.

Vent pipes must be secured at each joint with sheet metal screws.



VENT PIPE INSTALLATION

There must be a minimum of 6" clearance between single wall vent pipe and any combustible material. Fill and seal any clearance between single wall vent pipe and combustible material with mortar mix, cement, or other noncombustible substance. For other than single wall, follow vent pipe manufacturer's clearance specifications. To insure a tight fit of the vent pipe in a brick chimney, seal around the vent pipe with mortar mix cement.

▲ WARNING

Failure to have required clearances between vent piping and combustible material will result in a fire hazard.

▲ WARNING

Be sure vent pipe is properly connected to prevent escape of dangerous flue gases which could cause deadly asphyxiation.

▲ WARNING

Chemical vapor corrosion of the flue and vent system may occur if air for combustion contains certain chemical vapors. Spray can propellants, cleaning solvents, refrigerator and air conditioner refrigerants, swimming pool chemicals, calcium and sodium chloride, waxes, bleach, and process chemicals are typical compounds which are potentially corrosive.

Gas Piping

▲ WARNING

Make sure the gas supplied is the same type listed on the model rating plate. The inlet gas pressure must not exceed 10.5 in. water column (2.6kPa) for natural gas or 13 in. water column (3.2kPa) for propane (L.P.) gas. The minimum inlet gas pressure listed on the model rating plate is for the purpose of input adjustment.

▲ WARNING

If the gas control valve is subjected to pressures exceeding 1/2 pound per square inch (3.5kPa), the damage to the gas control valve could result in a fire or explosion from leaking gas.

▲ WARNING

If the main gas line shutoff serving all gas appliances is used, also turn "off" the gas at each appliance. Leave all gas appliances shut off until the water heater installation is complete.

A gas line of sufficient size must be run to the water heater. Consult the latest edition of National Fuel Gas Code ANSI Z223.1, also referred to as NFPA 54 and the gas company concerning pipe size.

There must be:

- A readily accessible manual shut off valve in the gas supply line serving the water heater, and
- A drip leg (sediment trap) ahead of the gas control valve to help prevent dirt and foreign materials from entering the gas control valve.
- A flexible gas connector or a ground joint union between the shutoff valve and control valve to permit servicing of the unit.

Be sure to check all the gas piping for leaks before lighting the water heater. Use a soapy water solution, not a match or open flame. Rinse off soapy solution and wipe dry.

Standard Models are for installation up to 3,300 feet above sea level.

High Altitude Models are for installation from 3,300 to 5,500 feet above sea level.

If a standard model is installed above 3,300 feet or a high altitude model is installed above 5,500 feet, the input rating must be reduced at the rate of 4 percent for each 1,000 feet above sea level. Contact your local Sears Service Center or gas utility for further information.

▲ WARNING

The appliance and its gas connection must be leak tested before placing the appliance in operation.

Installation Instructions (cont'd)

▲ WARNING

- The appliance and its individual shutoff valve must be disconnected from the gas supply piping system during any pressure testing of the gas system at test pressures in excess of ½ pound per square inch (3.5kPa).
- The appliance must be isolated from the gas supply piping system by closing its individual manual shutoff valve during any pressure testing of the gas supply piping system at test pressures equal or less than ½ pound per square inch (3.5kPa).

▲ WARNING

Use pipe joint compound or teflon tape marked as being resistant to the action of petroleum [Propane (L.P.)] gases.

SEDIMENT TRAP

A sediment trap shall be installed as close to the inlet of the water heater as practical at the time of water heater installation. The sediment trap shall be either a tee fitting with a capped nipple in the bottom outlet or other device recognized as an effective sediment trap. If a tee fitting is used, it shall be installed in conformance with one of the methods of installation shown below.

Connecting the gas piping to the gas control valve of the water heater can be accomplished by either of the two methods shown.

▲ WARNING

Contaminants in the gas lines may cause improper operation of the gas control valve that may result in fire or explosion. Before attaching the gas line be sure that all gas pipe is clean on the inside. To trap any dirt or foreign material in the gas supply line, a drip leg (sometimes called a sediment trap) must be incorporated in the piping. The drip leg must be readily accessible. Install in accordance with the "Gas Piping" section. Refer to the latest edition of the National Fuel Gas Code, ANSI Z223.1, also referred to as NFPA 54.

GAS PIPING WITH FLEXIBLE CONNECTOR

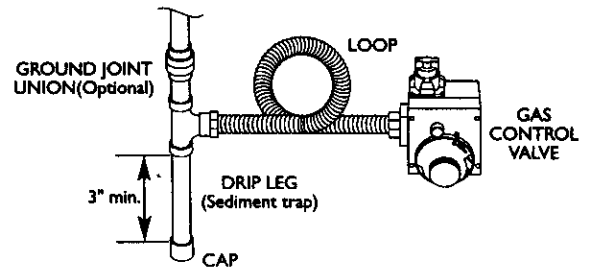

GAS PIPING WITH ALL BLACK IRON PIPE TO GAS CONTROL

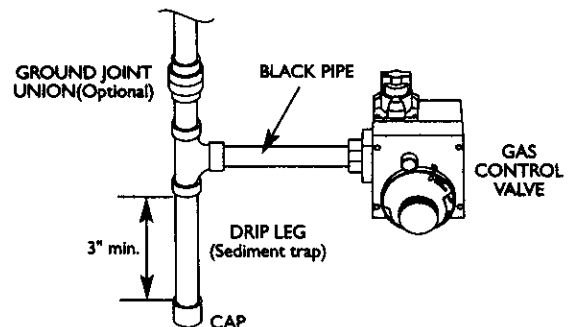

Installation Instructions (cont'd)

Installation Checklist

BEFORE LIGHTING THE PILOT:

- Check the gas lines for leaks.
 - a. Use a soapy water solution. DO NOT test for gas leaks using a match or open flame.
 - b. Brush the soapy water solution on all gas pipes, joints and fittings.
 - c. Check for bubbling soap. This means you have a leak. Turn "OFF" gas and make the necessary repairs.
 - d. Recheck for leaks.
 - e. Rinse off soapy solution and wipe dry.
- Is the new temperature-pressure relief valve properly installed and piped to an adequate drain? See "Temperature-Pressure Relief Valve" section.
- Are the cold and hot water lines connected to the water heater correctly? See "Water Piping" instructions in the "Installation Instructions" section.
- Is the water heater completely filled with water? See "Filling" instructions in the "Installation Instructions" section.
- Will a water leak damage anything? See the "Facts to Consider About the Location" section.
- Is there proper clearance between the water heater and anything that might catch fire? See the "Facts to Consider About the Location" section.
- Do you have adequate ventilation so that the water heater will operate properly? See "Combustion Air and Ventilation" in the "Facts to Consider About the Location" section.
- Is the draft hood vent piping properly secured? See "Venting" instructions in the "Installation Instructions" section.
- Is there proper clearance between the vent pipe and anything that might catch on fire? See "Venting" instructions in the "Installation Instructions" section.
- Is the vent pipe properly sloped and does the vent terminate outdoors? See "Venting" instructions in the "Installation Instructions" section.
- Do you need to call your gas company to check the gas pipe and its hookup?

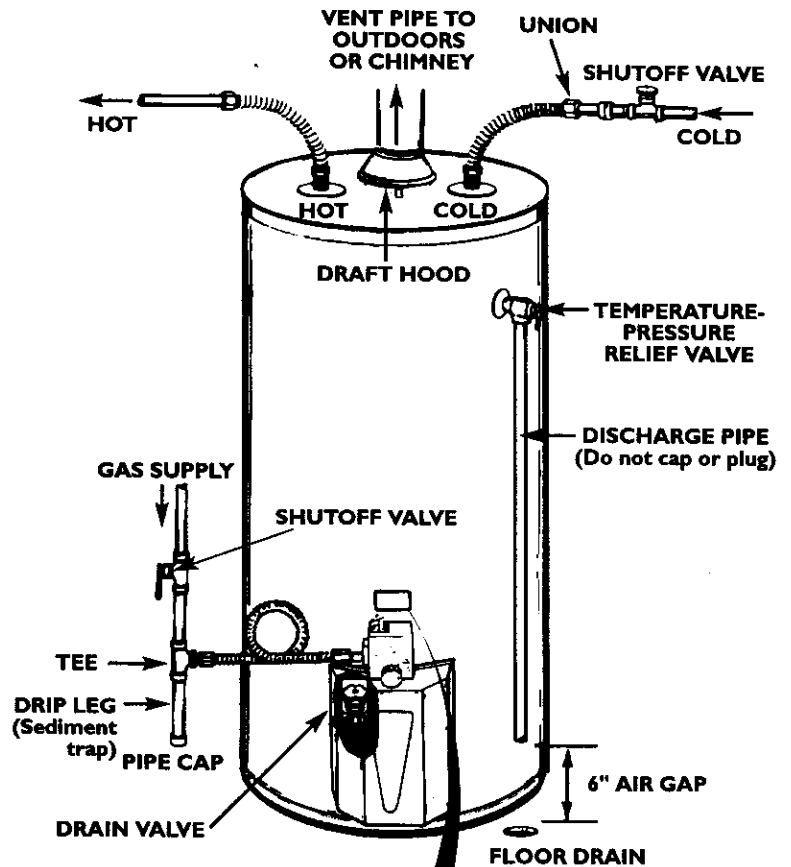

"AUTOMATIC STORAGE WATER HEATER"			
MODEL NUMBER		CAPACITY	
		U.S. GAL.	
EQUIPPED FOR		ANS Z21.10	
	INPUT	RECOVERY	SERIAL NUMBER
GAS	BTU/HR.	GAL./HR.	
MAXIMUM HYDROSTATIC WORKING PRESSURE		GAS PRESSURE IN W.C.	
150		MAX. INLET	MANIFOLD
P.S.I.	W.C.	W.C.	W.C.

MODEL RATING PLATE

Operating Instructions

Lighting

▲ WARNING

BEFORE LIGHTING [PROPANE (L.P.) GAS WATER HEATERS]: Propane (L.P.) gas is heavier than air. Should there be a leak in the system, the gas will settle near the ground. Basements, crawl spaces, skirted areas under mobile homes (even when ventilated), closets and areas below ground level will serve as pockets for the accumulation of this gas. Before attempting to light or relight the water heater's pilot or turning on a nearby electrical light switch, be absolutely sure there is no accumulated gas in the area. Search for odor of gas by sniffing at ground level in the vicinity of the appliance. If odor is detected, follow steps indicated at "For Your Safety" on the cover page of this manual then leave the premises.

Lighting and operating instructions are located on front of the water heater, above or to one side of the gas control valve.

▲ WARNING

AN ODORANT IS ADDED TO THE GAS USED BY THIS WATER HEATER.

**FOR YOUR SAFETY
IF YOU SMELL GAS:**

- Do not try to light any appliance.
- Do not touch any electrical switch; do not use any phone in your building.
- Immediately call your gas supplier from a neighbor's phone. Follow the gas supplier's instructions.
- If you cannot reach your gas supplier, call the fire department.

▲ WARNING

DO NOT force the gas control knob. Use only your hand to push it down to light the pilot, or to turn it to "ON", "OFF" or "PILOT". Never use a tool such as a lever, wrench or pliers. Do not hit or damage the knob. A damaged knob may result in an explosion and serious injury. If you have problem turning the knob, call the gas supplier immediately.

CHECK FOR LEAKS

Be sure to check all your gas pipes for leaks before lighting your water heater. Use a soapy water solution, not a match or open flame. Check the factory gas fittings after pilot is lit and gas control knob is still in "PILOT" position. Then, check the fittings when the main burner is turned "ON". Use a soapy water solution for this, too.

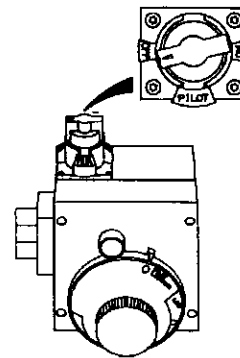

Figure 6

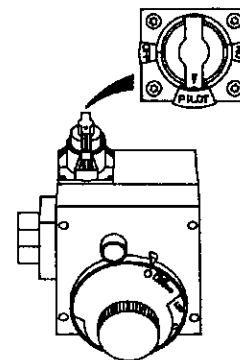

Figure 7

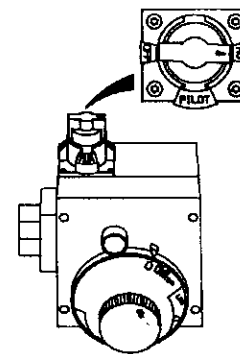

Figure 8

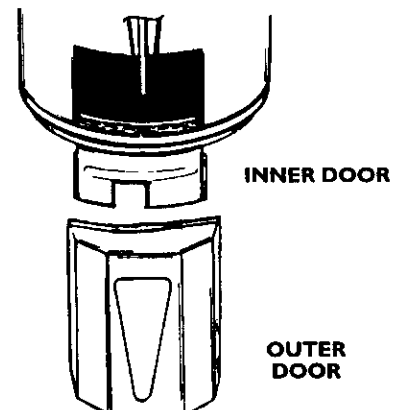

Figure 9

Operating Instructions (cont'd)

Lighting label on the water heater as it appears above the thermostat









FOR YOUR SAFETY READ BEFORE LIGHTING

WARNING

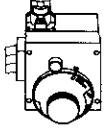
If you do not follow these instructions exactly, a fire or explosion may result causing property damage, personal injury or loss of life.

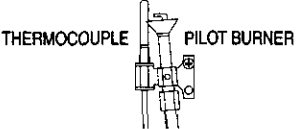
- A. This appliance has a pilot which must be lighted by hand. When lighting the pilot, follow these instructions exactly.
- B. **BEFORE LIGHTING** smell all around the appliance area for gas. Be sure to smell next to the floor because some gas is heavier than air and will settle on the floor.
- WHAT TO DO IF YOU SMELL GAS**
- Do not try to light any appliance.
 - Do not touch any electric switch; do not use any phone in your building.
 - Immediately call your gas supplier from a neighbor's phone. Follow the gas supplier's instructions.
- If you cannot reach your gas supplier, call the fire department.
- C. Use only your hand to push in or turn the gas control knob. Never use tools. If the knob will not push in or turn by hand, don't try to repair it, call a qualified service technician. Force or attempted repair may result in a fire or explosion.
- D. Do not use this appliance if any part has been under water. Immediately call a qualified service technician to inspect the appliance and to replace any part of the control system and any gas control which has been under water.



LIGHTING INSTRUCTIONS

1. **STOP!** Read the safety information above on this label.
2. Remove outer door. 
3. Set the thermostat to lowest setting by turning the water temperature dial clockwise, () to its lowest temperature setting (with arrow on dial) as shown. **DO NOT FORCE.**

4. Turn gas control knob clockwise () to "OFF" position. Knob cannot be turned from "PILOT" to "OFF" unless knob is depressed slightly. **DO NOT FORCE.** (Figure 6, page 17)
5. Wait five (5) minutes to clear out any gas. If you then smell gas, **STOP!** Follow "B" in the safety information above on this label. If you don't smell gas, go to the next step.
6. Remove (or open) inner door located below the gas control unit.
7. Find pilot-follow metal tube from gas control. The pilot is located in front of the burner.

8. If you don't smell gas, turn knob on gas control counter clockwise () to "PILOT" position. (Figure 7, page 17)
9. Push in control knob all the way and hold down. Immediately light the pilot with a match. Continue to hold control knob in for about one (1) minute after the pilot is lit. Release knob and it will pop back up. Pilot should remain lit. If it goes out, repeat steps 3 through 8.
 - If knob does not pop up when released, stop and immediately call your service technician or gas supplier.
 - If the pilot will not stay lit after several tries, depress and turn the gas control knob clockwise () to "OFF" and call your service technician or gas supplier. (Figure 6, page 17)
10. Replace (or close) inner door. Replace outer door if door does not cover gas control on/off knob or temperature adjustment knob. (Figure 9, page 17)
11. At arms length away, turn gas control knob counter-clockwise () to the full "ON" position. **Warning do not use gas control knob to regulate gas flow.** (Figure 8, page 17)
12. At arms length away, set the thermostat to desired setting. The mark (▲) indicative of approximate 120°F is preferred starting point. Some local laws may require a lower starting point. If hotter water is desired, see instruction manual and "warning" below.
13. Replace the outer door if not replaced in step 10.

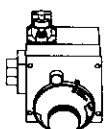
WARNING

Hotter water increases the risk of scald injury. Before changing temperature setting see instruction manual.

TO TURN OFF GAS TO APPLIANCE

1. Set the thermostat to lowest setting by turning the water temperature dial clockwise () to its lowest temperature setting (with arrow on dial) as shown. **DO NOT FORCE.**

2. Turn gas control knob clockwise () to "OFF" position. Knob cannot be turned from "PILOT" to "OFF" unless knob is depressed slightly. **DO NOT FORCE.**
3. Replace outer door (if removed).

Operating Instructions (cont'd)

Temperature Regulation

Due to the nature of the typical gas water heater, the water temperature in certain situations may vary up to 30°F higher or lower at the point of use such as, bathtubs, showers, sink, etc.

This means that when the temperature adjustment dial is set at the mark approximating 120° F, the actual water temperature at any hot water tap could be as high as 150°F or as low as 90°F.

Any water heater's intended purpose is to heat water. Hot water is needed for cleaning (bodies, dishes, clothing). Hot water will present a scald hazard. Depending on the time element, and the people involved (normal adults, children, toddlers, elderly, infirm, etc.) scalding may occur at different temperatures.

▲ WARNING

HOTTER WATER CAN SCALD: Water heaters are intended to produce hot water. Water heated to a temperature which will satisfy clothes washing, dish washing, and other sanitizing needs can scald and permanently injure you upon contact. Some people are more likely to be permanently injured by hot water than others. These include the elderly, children, the infirm, or physically/mentally handicapped. If anyone using hot water in your home fits into one of these groups or if there is a local code or state law requiring a certain temperature water at the hot water tap, then you must take special precautions. In addition to using the lowest possible temperature setting that satisfies your hot water needs, a means such as a mixing valve, should be used at the hot water taps used by these people or at the water heater. Mixing valves are available at plumbing supply or hardware stores. Follow manufacturers instructions for installation of the valves. Before changing the factory setting on the thermostat, read the "Temperature Regulation" section in this manual.

▲ WARNING

Never allow small children to use a hot water tap, or to draw their own bath water. Never leave a child or handicapped person unattended in a bathtub or shower.

The thermostat of this water heater has been factory set at its lowest position, to reduce the risk of scald injury. It is adjustable and must be reset to the desired temperature setting. The mark (▲) indicative of approximately 120°F is the preferred starting point. Some states have a requirement for a lower setting. If you need hotter water, follow directions for temperature adjustment, but beware of the warnings in this section.

Turn the water temperature dial clockwise (↻) to decrease the temperature, or counterclockwise (↺) to increase the temperature.

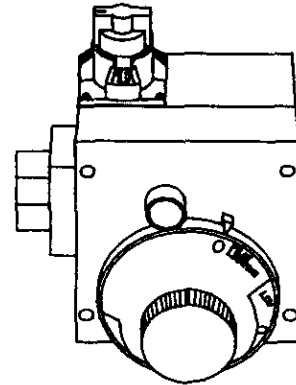

PILOT LIGHTING—Set here before attempting to light pilot.

▲—Is a thermostat setting of approximately 120°F, which will supply hot water at the most economical temperatures. The temperature adjustment knob can be turned lower than 120°F if desired.

A—Is a thermostat setting of approximately 130°F.

B—Is a thermostat setting of approximately 140°F.

C—Is a thermostat setting of approximately 150°F.

VERY HOT—Is a thermostat setting of 160°F. It is recommended that the dial be set lower whenever possible.

NOTE: Water temperature range of 120°—140°F recommended by most dishwasher manufacturers.

▲ WARNING

Should overheating occur or the gas supply fail to shut off, turn "OFF" the manual gas control valve to the appliance.

Service and Adjustment

Tank (Sediment) Cleaning

Sediment build-up on the tank bottom may create varying amounts of noise, and if left in the tank will cause premature tank failure. In some water areas, you may not be able to drain all sediment deposits by simply draining the tank. In these cases Mag Erad (part no. 23600) can be used to help remove the sediment deposits. This may be ordered from the Sears Service Center. For ordering, refer to the "Repair Parts" section.

Venting System Inspection

At least once a year a visual inspection should be made of the venting system. You should look for:

- Obstructions which could cause improper venting. The combustion and ventilation air flow must not be obstructed.
- Damage or deterioration which could cause improper venting or leakage of combustion products.
- Rusted flakes around top of water heater.

▲ WARNING

Chemical vapor corrosion of the flue and vent system may occur if air for combustion contains certain chemical vapors. Spray can propellants, cleaning solvents, refrigerator and air conditioner refrigerants, swimming pool chemicals, calcium and sodium chloride, waxes, bleach, and process chemicals are typical compounds which are potentially corrosive.

▲ WARNING

Obstructed or deteriorated vent systems may present a serious health risk or asphyxiation.

▲ WARNING

Be sure the vent piping is properly connected to prevent escape of dangerous flue gasses which could cause deadly asphyxiation.

▲ WARNING

If after inspection of the vent system you found sooting or deterioration, something is wrong. Call the local gas utility to correct the problem and clean or replace the flue and venting before resuming operation of the water heater.

Burner Inspection

▲ WARNING

Do not use this appliance if any part of it has been under water. Immediately call a Sears Service Technician to inspect the appliance and to replace the gas control or any part of the burner system which has been under water.

At least once a year a visual inspection should be made of the main burner and pilot burner. The drawing is for your reference.

You should check for sooting which is not normal and will impair proper combustion.

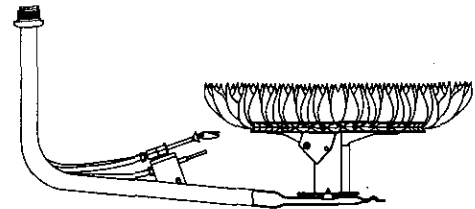

▲ WARNING

Soot build-up indicates a problem that requires correction before further use. Turn "OFF" gas to water heater and leave "OFF" until repairs are made, because failure to correct the cause of the sooting can result in a fire or explosion causing DEATH, SERIOUS BODILY INJURY, OR PROPERTY DAMAGE.

Burner Cleaning

In the event your burner needs cleaning, use the following instructions:

If inspection of the burner shows that cleaning is required, turn the gas control knob clockwise (↻) to the "OFF" position, depressing slightly.

NOTE: The knob cannot be turned from "PILOT" to "OFF" unless knob is depressed slightly. DO NOT FORCE.

Loose deposits on or around the burner can be removed by carefully using the hose of a vacuum cleaner inserted through the access door of the water heater. If the burner needs to be removed for additional cleaning, call the Sears Service Center to remove and clean the burner and correct the problem that required the burner to be cleaned.

Service and Adjustment (cont'd)

L.P. Gas Control Valve & Burner Assembly Replacement Information

▲ WARNING

PROPANE (L.P.) GAS CONTROL VALVE AND BURNER ASSEMBLY REPLACEMENT INFORMATION.

For Propane (L.P.) Gas Models Only:

Your water heater is equipped with a Propane (L.P.) gas control valve and a main burner assembly with left hand threads for the following fittings and their connections.

- The connection between the manifold and the gas control valve (A to B) are left hand threads.
- The connection between the main burner orifice and the manifold (C to D) are left hand threads.

For ordering these replacement parts, please refer to the "Repair Parts" section of this manual.

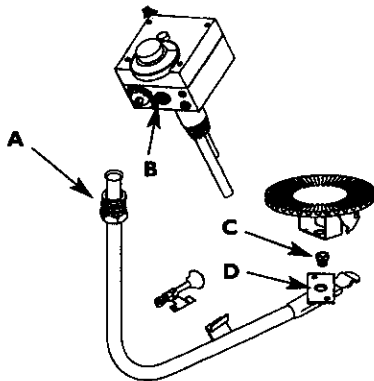

Draining

The water heater should be drained if being shut down during freezing temperatures. Also periodic draining and cleaning of sediment from the tank may be necessary.

- Turn the gas control knob to the "OFF" position.
- CLOSE the cold water inlet valve to the water heater.
- OPEN a nearby hot water faucet and leave open to allow for draining.
- Connect a hose to the drain valve and terminate to an adequate drain.
- OPEN the water heater drain valve to allow for tank draining.

NOTE: If the water heater is going to be shut down and drained for an extended period, the drain valve should be left open with hose connected allowing water to terminate to an adequate drain.

- Close the drain valve.
- Follow instructions in the "Filling The Water Heater" section.
- Follow the lighting instructions in the "Lighting" section to restart the water heater.

Temperature-Pressure Relief Valve Operation

The temperature-pressure relief valve must be manually operated at least once a year.

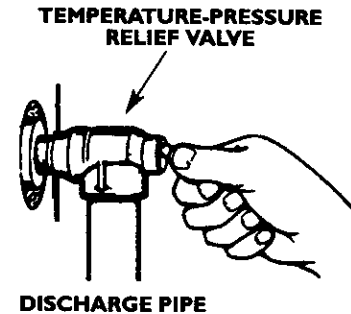

Failure to install and maintain a new properly listed temperature-pressure relief valve will release the manufacturer from any claim which might result from excessive temperature or pressure.

▲ WARNING

If the temperature-pressure relief valve on the appliance weeps or discharges periodically, this may be due to thermal expansion. Your water heater may have a check valve installed in the water line or a water meter with a check valve. Consult the Sears Service Center for further information. Do not plug the temperature-pressure relief valve.

▲ WARNING

When checking the temperature-pressure relief valve operation, make sure that (1) no one is in front of or around the outlet of the temperature-pressure relief valve discharge line, and (2) that the water manually discharged will not cause any property damage because the water may be extremely hot.

If after manually operating the valve, it fails to completely reset and continues to release water, immediately close the cold water inlet to the water heater, follow the draining instructions, and replace the temperature-pressure relief valve with a new one.

Service and Adjustment (cont'd)

Drain Valve Washer Replacement

NOTE: For replacement, use a $\frac{1}{32}$ " x $\frac{1}{4}$ " x $\frac{1}{8}$ " thick washer available at your nearest hardware store. For ordering replacement washers, refer to the "Parts Order List" section.

- Turn "OFF" gas supply to water heater.
- Follow "Draining" instructions.
- Turning counter clockwise, remove the hex cap below the screw handle.
- Remove the washer and put the new one in place.
- Screw the handle and cap assembly back into the drain valve and retighten using a wrench. **DO NOT OVER TIGHTEN.**
- Follow instructions in the "Filling The Water Heater" section.
- Check for leaks.
- Follow the lighting instructions in the "Lighting" section to restart the water heater.



Housekeeping

Vacuum around base of water heater for dust, dirt, and lint on a regular basis.

▲ WARNING

INSTALLED IN SUITABLE AREA: To insure sufficient ventilation and combustion air supply, proper clearances from the water heater must be maintained. See "Facts to Consider About the Location" section. Combustible materials such as clothing, cleaning materials, or flammable liquids, etc. must not be placed against or adjacent to the water heater which can cause a fire.

Service

Before calling for repair service, read the Start Up Conditions and Operational Conditions found in the Troubleshooting Guide of this manual.

If a condition persists or you are uncertain about the operation of the water heater, let a qualified person check it out.

Contact SEARS Repair Services at 1-800-4-MY-HOME (1-800-469-4663).

Troubleshooting Guide

Start Up Conditions

THERMAL EXPANSION

Water supply systems may, because of such events as high line pressure, frequent cut-offs, the effects of water hammer among others, have installed devices such as pressure reducing valves, check valves, back flow preventers, etc...to control these types of problems. When these devices are not equipped with an internal by-pass, and no other measures are taken, the devices cause the water system to be closed. As water is heated, it expands (thermal expansion) and closed systems do not allow for the expansion of heated water.

The water within the water heater tank expands as it is heated and increases the pressure of the water system. If the relieving point of the water heater's temperature-pressure relief valve is reached, the valve will relieve the excess pressure. **The temperature-pressure relief valve is not intended for the constant relief of thermal expansion.** This is an unacceptable condition and must be corrected.

It is recommended that any devices installed which could create a closed system have a by-pass and/or the system have an expansion tank to relieve the pressure built by thermal expansion. Thermal expansion tanks are available from Sears stores and through the Sears Service Centers. Contact the local plumbing inspector, water supplier and/or the Sears Service Center for assistance in controlling these situations.

Thermal Expansion Tank Specifications

Model Number	Tank Capacity In Gallons	Dimensions in Inches		Pipe Fitting On Tank
		Diameter	Length	
153.331020	2	8 inches	12¾ inches	¾" Male
153.331050	5	11 inches	14¾ inches	¾" Male

Expansion Tank Sizing Chart

Expansion Tank Capacity Needed	Inlet* Water Pressure	Water Heater Capacity (Gallons)				
		30	40	50	66	82
40psi		2	2	2	5	5
50psi		2	2	2	5	5
60psi		2	2	5	5	5
70psi		2	2	5	5	5
80psi		2	5	5	5	5

*Highest recorded inlet water pressure in a 24 hour period or regulated water pressure.

NOTE: Expansion tanks are pre-charged with a 40 psi air charge. If the inlet water pressure is higher than 40 psi, the expansion tank's air pressure must be adjusted to match that pressure, but must not be higher than 80 psi.

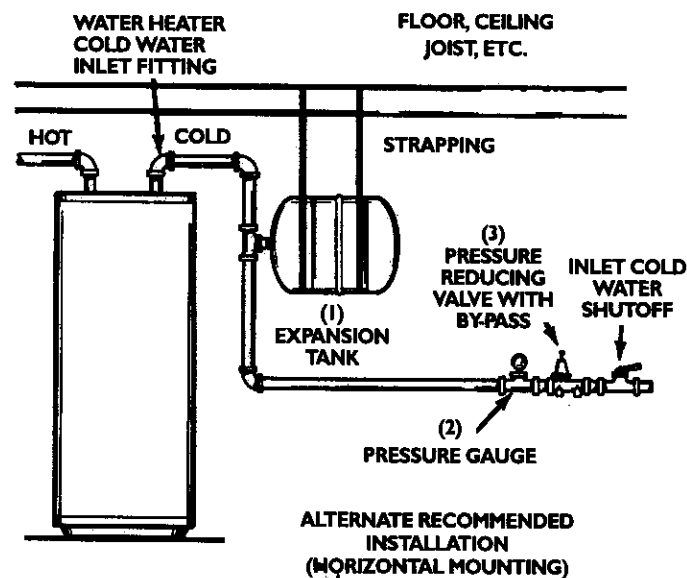
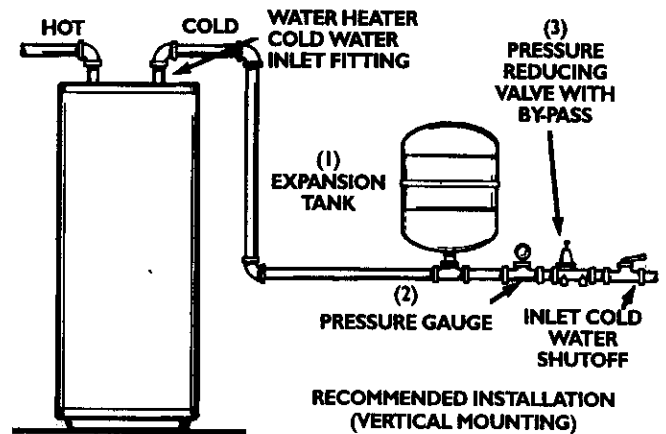

STRANGE SOUNDS

Possible noises due to expansion and contraction of some metal parts during periods of heat-up and cool-down do not represent harmful or dangerous conditions.

Condensation causes sizzling and popping with the burner area during heating and cooling periods and should be considered normal. See "Condensation" section.

Troubleshooting Guide (cont'd)

Start Up Conditions (cont'd)

CONDENSATION

Whenever the water heater is filled with cold water, a certain amount of condensation will form while the burner is on. A water heater may appear to be leaking when in fact the water is condensation. This usually happens when:

- When a new water heater is filled with cold water for the first time.
- When gas burns and water vapor is produced in water heaters, particularly high efficiency models where flue temperatures are lower.
- When you use large amounts of hot water in a short time and the refill water is very cold.

Moisture from the products of combustion condense on the cooler tank surfaces and form drops of water which may fall onto the burner or other hot surfaces to produce a "sizzling" or "frying" noise.

Excessive condensation can cause pilot outage due to water running down the flue tube onto the main burner and putting out the pilot.

Because of the suddenness and amount of water, condensation water may be diagnosed as a "tank leak". After the water in the tank warms up (about 1-2 hours), the condition should disappear.

Do not assume the water heater is leaking until there has been enough time for the water in the tank to warm up.

An undersized water heater will cause more condensation. The water heater must be sized properly to meet the family's demands for hot water including dishwashers, washing machines and shower heads.

Excessive condensation may be noticed during the winter and early spring months when incoming water temperatures are at their lowest.

Good venting is essential for a gas fired water heater to operate properly as well as to carry away products of combustion and water vapor.

SMOKE/ODOR

It is not uncommon to experience a small amount of smoke and odor during the initial start-up. This is due to burning off of oil from metal parts, and will disappear in a short while.

Operational Conditions

SMELLY WATER

In each glasslined water heater there is installed at least one anode rod (see parts section) for corrosion protection of the tank. Certain water conditions will cause a reaction between this rod and the water. The most common complaint associated with the anode rod is one of a "rotten egg smell". This odor is derived from hydrogen sulfide gas dissolved in the water. The smell is the result of four factors which must all be present for the odor to develop:

- a. a concentration of sulfate in the supply water.
- b. little or no dissolved oxygen in the water.
- c. a sulfate reducing bacteria within the water heater. (This harmless bacteria is non-toxic to humans.)
- d. an excess of active hydrogen in the tank. This is caused by the corrosion protective action of the anode.

Smelly water may be eliminated or reduced in some water heater models by replacing the anode(s) with one of less active material, and then chlorinating the water heater tank and all hot water lines. Contact Sears Service for further information concerning an Anode Replacement Kit #9001453 and this Chlorination Treatment.

If the smelly water persists after the anode replacement and chlorination treatment, we can only suggest that continuous chlorination and filtering conditioning equipment be considered to eliminate the water problem.

Do not remove the anode leaving the tank unprotected. By doing so, all warranty on the water heater tank is voided.

"AIR" IN HOT WATER FAUCETS

▲ WARNING

HOTTER WATER CAN SCALD: Water heaters are intended to produce hot water. Water heated to a temperature which will satisfy clothes washing, dish washing, and other sanitizing needs can scald and permanently injure you upon contact. Some people are more likely to be permanently injured by hot water than others. These include the elderly, children, the infirm, or physically/mentally handicapped. If anyone using hot water in your home fits into one of these groups or if there is a local code or state law requiring a certain temperature water at the hot water tap, then you must take special precautions. In addition to using the lowest possible temperature setting that satisfies your hot water needs, a means such as a mixing valve, should be used at the hot water taps used by these people or at the water heater. Mixing valves are available at plumbing supply or hardware stores. Follow manufacturers instructions for installation of the valves. Before changing the factory setting on the thermostat, read the "Temperature Regulation" section in this manual.

▲ WARNING

HYDROGEN GAS: Hydrogen gas can be produced in a hot water system that has not been used for a long period of time (generally two weeks or more). Hydrogen gas is extremely flammable and explosive. To prevent the possibility of injury under these conditions, we recommend the hot water faucet be opened for several minutes at the kitchen sink before any electrical appliances which are connected to the hot water system are used (such as a dishwasher or washing machine). If hydrogen gas is present, there will probably be an unusual sound similar to air escaping through the pipe as the hot water faucet is opened. There must be no smoking or open flame near the faucet at the time it is open.

Troubleshooting Guide (cont'd)

HIGH TEMPERATURE SHUT OFF SYSTEM

This water heater is equipped with an automatic gas shut off system. The high temperature shut off is built into the gas control valve. This system shuts off the gas supply to the water heater burners when high water temperatures are present. It is non-resettable. If the high temperature shut off activates, the gas control valve must be replaced. If this were to occur, turn "OFF" the entire gas supply to the water heater. Contact the Sears Service Center.

▲ WARNING

Should overheating occur or the gas supply fail to shut off, turn "OFF" the manual gas control valve to the appliance.

▲ WARNING

Due to the nature of the typical gas water heater, the water temperature in certain situations may be hotter than the thermostat setting.

Short, frequent draws of hot water - especially with very cold incoming water - can shock the thermostat into brief operation resulting in hotter and hotter layers of water closer to the top of the tank.

Changes in hot water usage patterns or raising the temperature differential between the cut-on of the thermostat and the cold water temperature will usually eliminate the problem.

NOT ENOUGH OR NO HOT WATER

- Check the manual gas shut off valve to be sure it is open.
- Check the pilot flame. It may have gone out. All models have an opening behind the outer door for viewing the pilot.
- If the pilot is not lit, follow the "Lighting" instructions in this manual or located above the gas control valve on the water heater to relight the pilot. If the water was extremely hot and is now cold, the high limit safety temperature shut off may have put out the burner and pilot. If the high temperature shut off activates, the gas control valve must be replaced. Contact the Sears Service Center.
- The gas control knob must be turned to the "ON" position.
- The temperature adjustment dial may be set too low. See the "Temperature Regulation" section.
- The gas company can check the gas input to see if it is correct. An underfired water heater will not heat water as quickly.
- Look for leaking or open hot water faucets. Make sure all are closed.
- The cold water inlet temperature may be colder during the winter months. It will take longer to heat the water and seem like less hot water.
- If you cannot find what is wrong, call the Sears Service Center.

WATER IS TOO HOT

- The temperature adjustment dial may be set too high. See the "Temperature Adjustment" section.

NOTE: A period of time is necessary after an adjustment has been made for the water temperature to reach the new temperature setting.

- If lower temperature settings will not lower the water temperature, call the Sears Service Center.

Troubleshooting Guide (cont'd)

Leakage Checkpoints

Use this guide to check a "Leaking" water heater. Many suspected "Leakers" are not leaking tanks. Often the source of the water can be found and corrected.

If you are not thoroughly familiar with your local gas codes your water heater, and safety practices, contact the Sears Service Center to check the water heater.

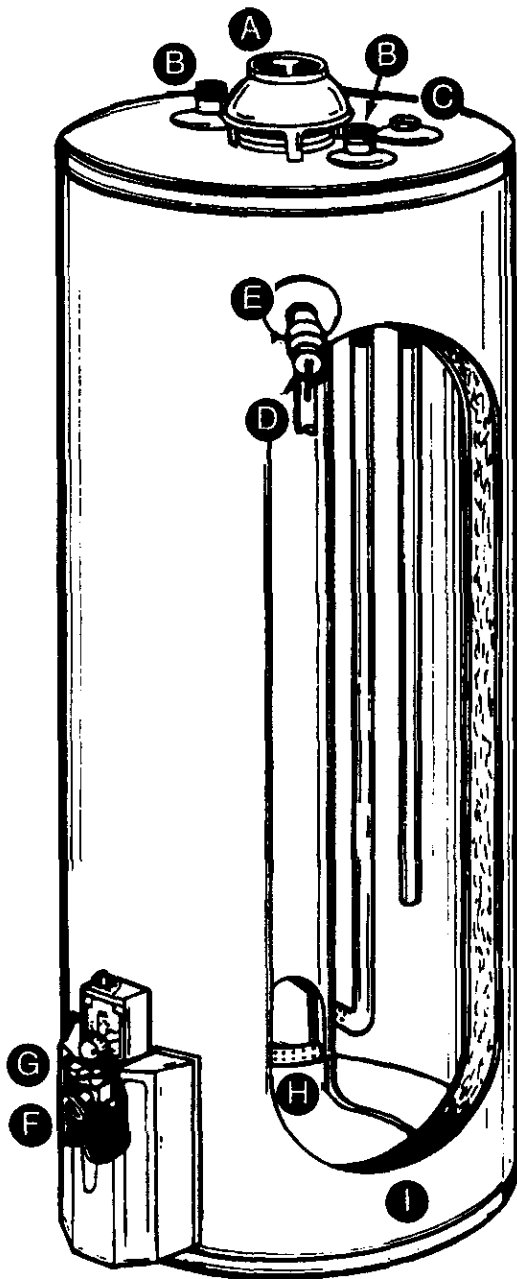

▲ CAUTION

Read this manual first. Then before checking the water heater make sure the gas supply has been turned "OFF", and never turn the gas "ON" before the tank is completely full of water.

▲ CAUTION

Never use this water heater unless it is completely filled with water. To prevent damage to the tank, the tank must be filled with water. Water must flow from the hot water faucet before turning "ON" gas to the water heater.

- A** Water at the draft hood is water vapor which has condensed out of the combustion products. This is caused by a problem in the vent. Contact the Sears Service Center
- B** *Condensation may be seen on pipes in humid weather or pipe connections may be leaking.
- C** *The primary anode rod fitting may be leaking.
Small amounts of water from temperature-pressure relief valve may be due to thermal expansion or high water pressure in your area.
*The temperature-pressure relief valve may be leaking at the tank fitting.
- F** Water from a drain valve may be due to the valve opened slightly.
- G** *The drain valve may be leaking at the tank fitting.
- H** Combustion products contain water vapor which can condense on the cooler surfaces of the tank. Droplets form and drip into the fire or run on the floor. This is common at the time of startup after installation and when incoming water is cold.
- I** Water in the water heater bottom or on the floor may be from condensation, loose connections, or the relief valve. DO NOT replace the water heater until a full inspection of all possible water sources is made and necessary corrective steps taken. Leakage from other appliances, water lines, or ground seepage should also be checked.

NOTE: To check where threaded portion enters tank, insert cotton swab between jacket opening and fitting. If cotton is wet, follow "Draining" instructions in the "Service and Adjustment" section and then remove fitting. Put pipe dope or teflon tape on the threads and replace. Then follow "Filling the Water Heater" instructions in the "Installation Instructions" section.

Notes

Notes

Notes

Parts Order List

POWER MISER™ 9 GAS WATER HEATERS

MODEL NUMBERS:

153.337114	50 Gal. Short High Altitude
153.337163	50 Gal. Short
153.337214	40 Gal. Short High Altitude
153.337263	40 Gal. Short
153.337363	30 Gal.
153.337414	40 Gal. High Altitude

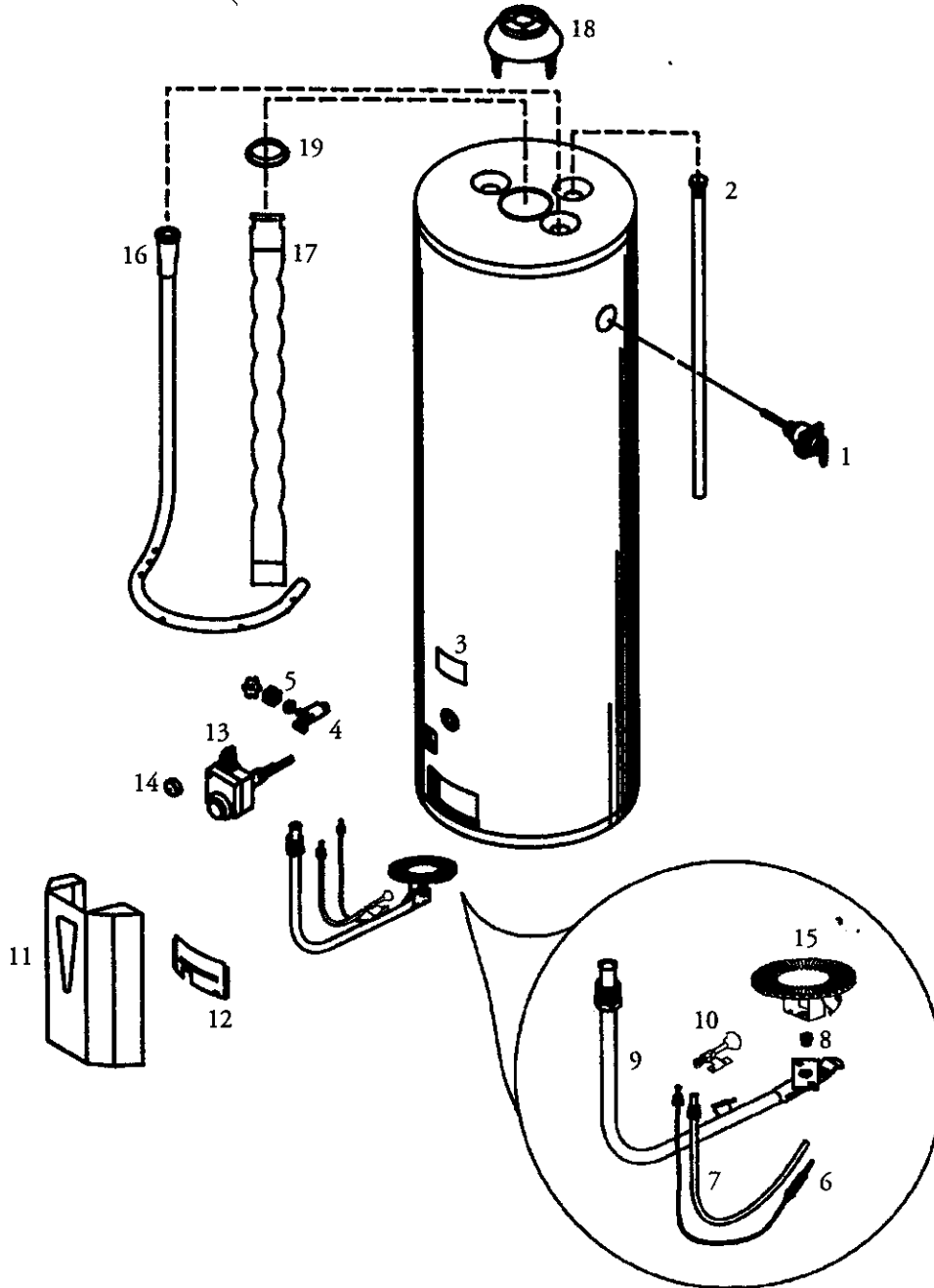

Parts Order List (cont'd)

POWER MISER™ 9 GAS WATER HEATERS

MODEL NUMBERS:

- 153.337114 50 Gal. Short High Altitude
- 153.337163 50 Gal. Short
- 153.337214 40 Gal. Short High Altitude
- 153.337263 40 Gal. Short
- 153.337363 30 Gal.
- 153.337414 40 Gal. High Altitude

KEY NO.	PART DESCRIPTION	Model Numbers					
		153.337114	153.337163	153.337214	153.337263	153.337363	153.337414
		PART NUMBERS					
1	Temperature-Pressure Relief Valve	9000071	9000071	9000071	9000071	9000071	9000071
2	Primary Anode Rod	9000734	9000734	9001829	9001829	9000734	9000734
3	Model Rating Plate †	0270118	0270118	0270118	0270118	0270118	0270118
4	Drain Valve	9000254	9000254	9000254	9000254	9000254	9000254
5	Drain Valve Washer (¹ / ₃₂ " x ¹ / ₄ " x ¹ / ₈ " thick)**	9001584	9001584	9001584	9001584	9001584	9001584
6	Thermocouple*	42-33900	42-33900	42-33900	42-33900	42-33900	42-33900
7	Pilot Tubing w/Fittings	9000278	9000278	9000278	9000278	9000278	9000278
8	Burner Orifice	0230141 #36(HA)	0230120 #33	0230141 #36(HA)	0230120 #33	0230120 #33	0230141 #36(HA)
9	Manifold	9002619	9002619	9002617	9002617	9002613	9002615
10	Pilot	9000285	9000285	9000285	9000285	9000285	9000285
11	Manifold Cover	9000358	9000358	9000358	9000358	9000358	9000358
12	Inner Door	9000281	9000281	9000281	9000281	9000281	9000281
13	Gas Control Valve	F145-1278	F145-1278	F145-1278	F145-1278	F145-1278	F145-1278
14	Temperature Adjustment Knob	F145-1280	F145-1280	F145-1280	F145-1280	F145-1280	F145-1280
15	Burner	9002411	9002411	9002411	9002411	9002411	9002411
16	Dip Tube	9002067	9002067	9001981	9001981	9001698	9001698
17	Flue Baffle	9002495	9002495	9002281	9002281	9002490	9000516
18	Draft Hood	9000273	9000273	9000273	9000273	9000273	9000273
19	Restrictor Ring	9001208	9001208	9000275	9000275	9000275	9000275
#	Manual	0002917070					
#	Mag-Erad	23600					

Now that you have purchased your Gas Water Heater, should a need ever exist for repair parts or service, simply contact any SEARS Service Center or call 1-800-4-MY-HOME (1-800-469-4663). Be sure to provide pertinent facts when you call or visit.

All parts listed may be ordered from any SEARS Service Center, most SEARS stores and by calling 1-800-366-PART (1-800-366-7247). If the parts you need are not stocked locally, your order will be electronically transmitted to a SEARS Repair Parts Distribution Center for handling.

The model number of your Gas Water Heater will be found on the model rating plate located near the gas control valve.

WHEN ORDERING REPAIR PARTS, ALWAYS GIVE THE FOLLOWING INFORMATION:

MODEL NUMBER PART DESCRIPTION
PART NUMBER NAME OF ITEM

THIS IS A REPAIR PARTS LIST, NOT A PACKING LIST.

Parts Order List (cont'd)

POWER MISER™ 9 GAS WATER HEATERS

MODEL NUMBERS:

- 153.337463 40 Gal.
- 153.337514 50 Gal. High Altitude
- 153.337563 50 Gal.
- 153.337614 65 Gal. High Altitude

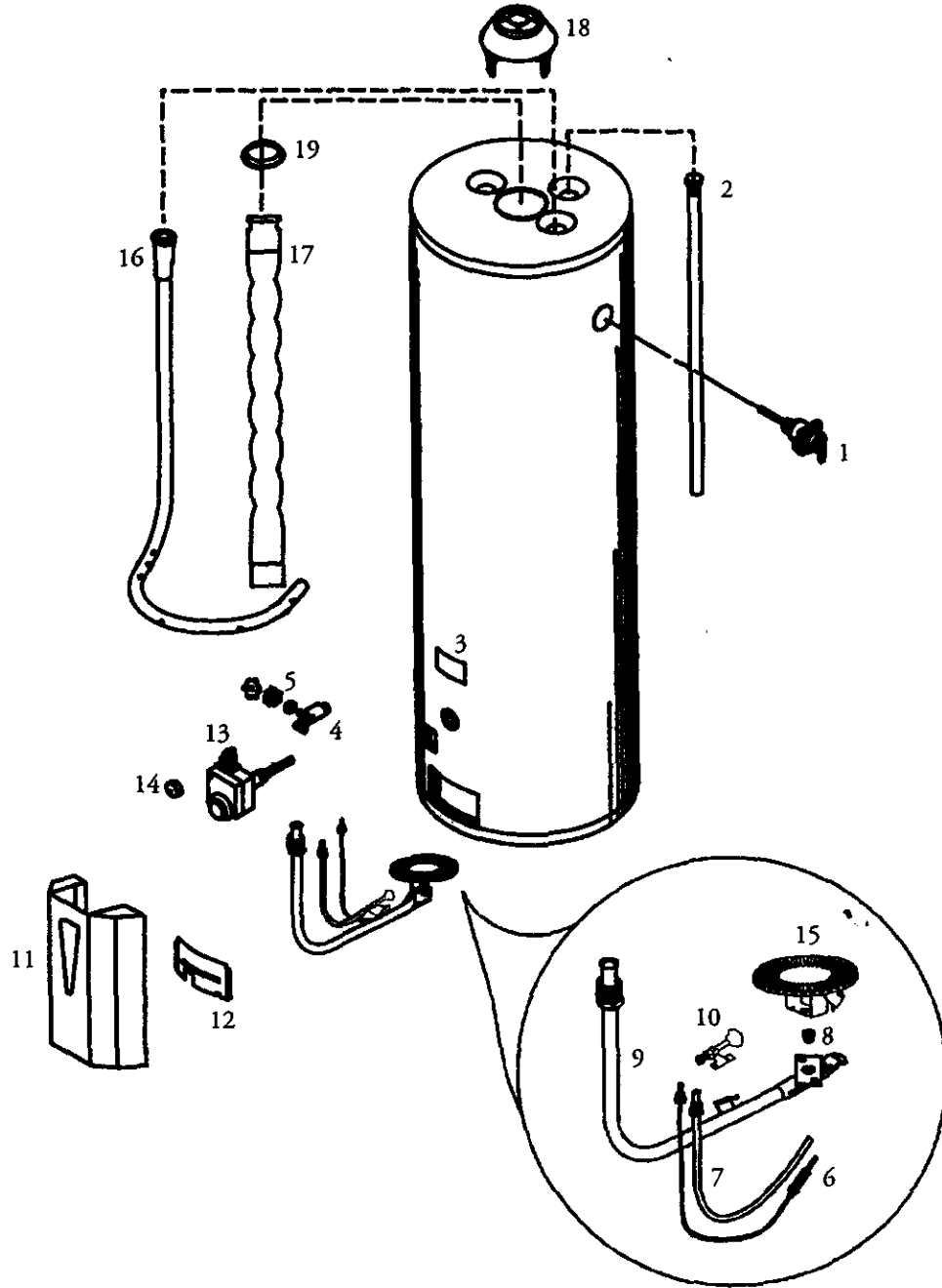

Parts Order List (cont'd)

POWER MISER™ 9 GAS WATER HEATERS

MODEL NUMBERS:

153.337463 40 Gal.
 153.337514 50 Gal. High Altitude
 153.337563 50 Gal.
 153.337614 65 Gal. High Altitude

KEY NO.	PART DESCRIPTION	Model Numbers			
		153.337463	153.337514	153.337563	153.337614
		PART NUMBERS			
1	Temperature-Pressure Relief Valve	9000071	9000071	9000071	9000071
2	Primary Anode Rod	9000734	9000734	9000734	9000734
3	Model Rating Plate †	0270118	0270118	0270118	0270118
4	Drain Valve	9000254	9000254	9000254	9000254
5	Drain Valve Washer ($\frac{1}{2}$ " x $\frac{1}{4}$ " x $\frac{1}{8}$ " thick)**	9001584	9001584	9001584	9001584
6	Thermocouple*	42-33900	42-33900	42-33900	42-33900
7	Pilot Tubing w/Fittings	9000278	9000278	9000278	9000278
8	Burner Orifice	0230120 #33	0230141 #36(HA)	0230120 #33	0230141 #36(HA)
9	Manifold	9002615	9002617	9002617	9002619
10	Pilot	9000285	9000285	9000285	9000285
11	Manifold Cover	9000358	9000358	9000358	9000358
12	Inner Door	9000281	9000281	9000281	9000281
13	Gas Control Valve	F145-1278	F145-1278	F145-1278	F145-1278
14	Temperature Adjustment Knob	F145-1280	F145-1280	F145-1280	F145-1280
15	Burner	9002411	9002411	9002411	9002411
16	Dip Tube	9001698	9001698	9001698	9001982
17	Flue Baffle	9000516	9000298	9002496	9000419
18	Draft Hood	9000273	9000273	9000273	9000273
19	Restrictor Ring	9000275	9000275	9000275	9000275
#	Manual	0002917070			
#	Mag-Erad	23600			

Now that you have purchased your Gas Water Heater, should a need ever exist for repair parts or service, simply contact any SEARS Service Center or call 1-800-4-MY-HOME (1-800-469-4663). Be sure to provide pertinent facts when you call or visit.

All parts listed may be ordered from any SEARS Service Center, most SEARS stores and by calling 1-800-366-PART (1-800-366-7247). If the parts you need are not stocked locally, your order will be electronically transmitted to a SEARS Repair Parts Distribution Center for handling.

The model number of your Gas Water Heater will be found on the model rating plate located near the gas control valve.

WHEN ORDERING REPAIR PARTS, ALWAYS GIVE THE FOLLOWING INFORMATION:

MODEL NUMBER PART DESCRIPTION
 PART NUMBER NAME OF ITEM

THIS IS A REPAIR PARTS LIST, NOT A PACKING LIST.

Parts Order List (cont'd)

POWER MISER™ 9 GAS WATER HEATERS

MODEL NUMBERS:

- 153.337663 65 Gal.
- 153.337763 50 Gal. High Recovery
- 153.337863 65 Gal. High Recovery
- 153.337962 40 Gal. (L.P.)

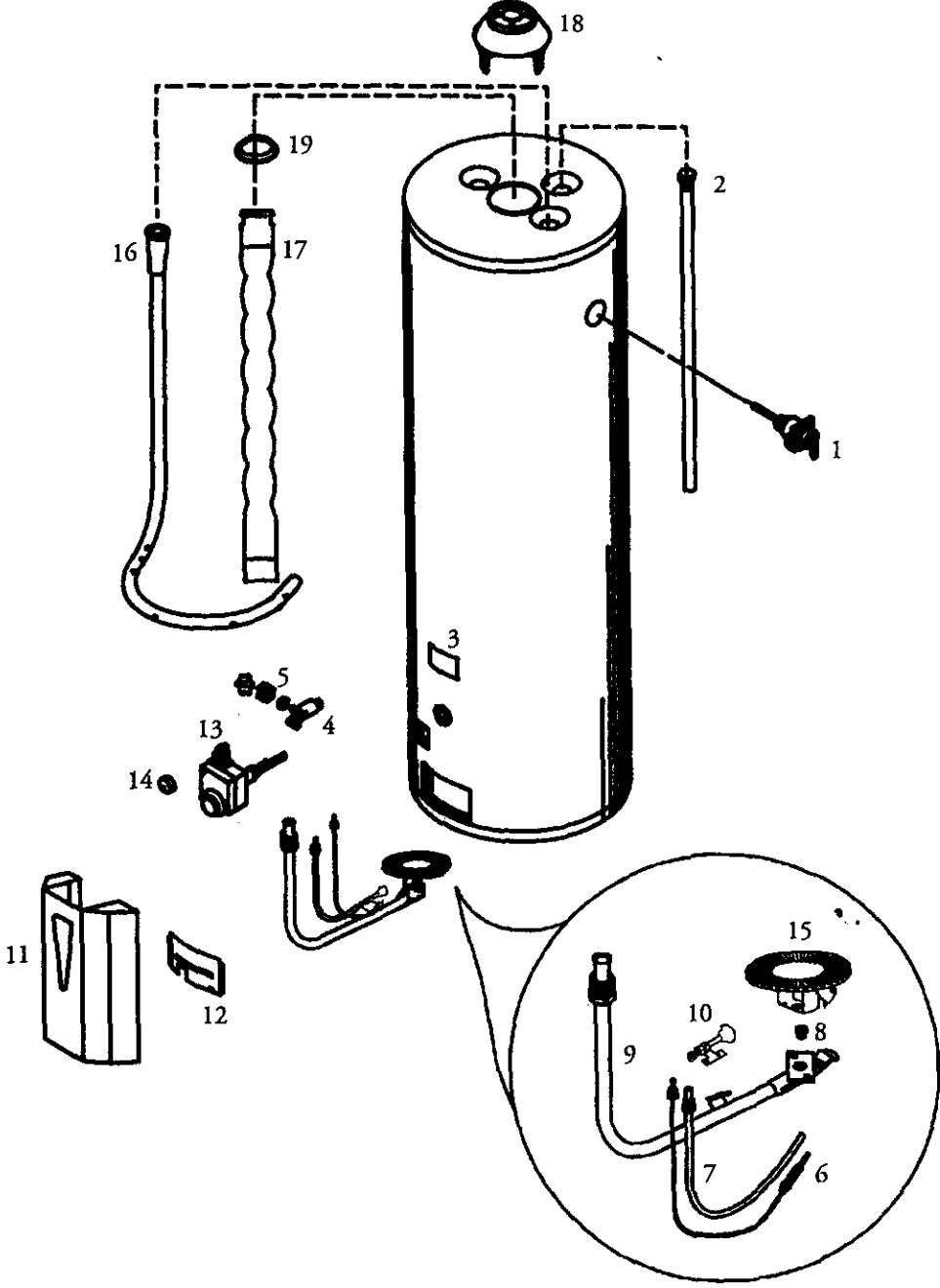

Parts Order List (cont'd)

POWER MISER™ 9 GAS WATER HEATERS

MODEL NUMBERS:

153.337663 65 Gal.
 153.337763 50 Gal. High Recovery
 153.337863 65 Gal. High Recovery
 153.337962 40 Gal. (L.P.)

KEY NO.	PART DESCRIPTION	Model Numbers			
		153.337663	153.337763	153.337863	153.337962
		PART NUMBERS			
1	Temperature-Pressure Relief Valve	9000071	9000071	9000071	9000071
2	Primary Anode Rod	9000734	9000734	9000734	9000734
3	Model Rating Plate †	0270118	0270118	0270118	0270118
4	Drain Valve	9000254	9000254	9000254	9000254
5	Drain Valve Washer (1/32" x 1/4" x 1/8" thick)**	9001584	9001584	9001584	9001584
6	Thermocouple*	42-33900	42-33900	42-33900	42-33900
7	Pilot Tubing w/Fittings	9000278	9000278	9000278	9000278
8	Burner Orifice (Drill Size)	0230120 #33	0230124 #30	0230124 #30	0230223 #49
9	Manifold	9002619	9002617	9002619	9002616
10	Pilot	9000285	9000285	9000285	9000287
11	Manifold Cover	9000358	9000358	9000358	9000358
12	Inner Door	9000281	9000281	9000281	9000281
13	Gas Control Valve	F145-1278	F145-1278	F145-1278	F145-1279
14	Temperature Adjustment Knob	F145-1280	F145-1280	F145-1280	F145-1280
15	Burner	9002411	9002411	9002411	9002411
16	Dip Tube	9001982	9001698	9001982	9001698
17	Flue Baffle	9000419	9000371	9000299	9000516
18	Draft Hood	9000273	9000274	9000274	9000273
19	Restrictor Ring	9000275	9000297	9000297	9000275
#	Manual	0002917070			
#	Mag-Erad	23600			

Note "A": For Propane (L.P.) model(s) this part has left hand threads.

* These parts are also available at most Sears retail stores.

** Also available at most hardware stores.

† Replaced only on return of damaged plate.

Not Illustrated

Now that you have purchased your Gas Water Heater, should a need ever exist for repair parts or service, simply contact any SEARS Service Center or call 1-800-4-MY-HOME (1-800-469-4663). Be sure to provide pertinent facts when you call or visit.

All parts listed may be ordered from any SEARS Service Center, most SEARS stores and by calling 1-800-366-PART (1-800-366-7247). If the parts you need are not stocked locally, your order will be electronically transmitted to a SEARS Repair Parts Distribution Center for handling.

The model number of your Gas Water Heater will be found on the model rating plate located near the gas control valve.

WHEN ORDERING REPAIR PARTS, ALWAYS GIVE THE FOLLOWING INFORMATION:

MODEL NUMBER PART DESCRIPTION
 PART NUMBER NAME OF ITEM

THIS IS A REPAIR PARTS LIST, NOT A PACKING LIST.

Warranty

About Your Warranty

THE PRICE OF YOUR WATER HEATER DOES NOT INCLUDE A FREE CHECKUP SERVICE CALL. On Water Heater Installations Arranged By Sears, Sears warrants the installation.

ON INSTALLATIONS NOT MADE BY SEARS AUTHORIZED CONTRACTORS:

1. Your Sears warranty applies to the product only.
2. Sears does not warrant the installation.
3. A charge will be made on service calls due to poor or incomplete installation. These include:

- a. Adjusting thermostat.
- b. Lighting pilot.
- c. Leaks in pipes or fittings.
- d. Improper venting
- e. Condensation

This manual is in non-technical language. It may help you avoid the cost of a needless service call. Many service calls really aren't needed.

Such as when:

1. The gas is turned "OFF".
2. The pilot is out.
3. A gas or water leak is due to loose pipe or connections.

FULL ONE YEAR WARRANTY ON WATER HEATER

For one year from the date of purchase, when your Sears Kenmore water heater is installed and operated in a single-family residence in accordance with the instructions in this manual, Sears will:

1. Repair defects in material or workmanship in this water heater, free of charge.
2. Furnish and install a new current model water heater of equal capacity and quality, free of charge, if a leak occurs in the tank.

LIMITED WARRANTY ON TANKS THAT LEAK

After one year and through 9 years from the date of purchase for water heaters used in a single-family residence, if a leak occurs in the tank, Sears will furnish a new current model water heater of equal capacity and quality. You will be charged for any installation.

LIMITED WARRANTY ON PARTS

After one year and through 9 years from the date of purchase, when your Sears Kenmore water heater is used in a single-family residence and is installed and operated in accordance with the information in this manual, if a part fails due to a materials or workmanship, Sears will furnish a replacement free of charge. You will be charged for labor.

If the water heater is subjected to commercial, institutional, industrial or use in residences of two families or more, the above warranty coverage for tanks that leak is effective for 2 years from the date of purchase and the above parts warranty is effective for 1 year from the date of purchase.

To obtain warranty service, SIMPLY CALL 1-800-4MY-HOME (1-800-469-4663). "This warranty applies only while this product is in use in the United States."

This warranty gives you specific legal rights and you may also have other rights which vary from state to state.

SEARS, ROEBUCK AND CO., Dept. 817 WA, HOFFMAN ESTATES, IL 60179

Sears Installation Warranty

In addition to any warranty extended to you on the Sears merchandise involved, which warranty becomes effective the date the merchandise is installed should the workmanship of any Sears arranged installation prove faulty within one year, Sears will, upon notice from you, cause such faults to be corrected at no additional cost to you. If you want this heater professionally installed by Sears contact your Sears Salesperson. They will arrange for prompt, quality installation.

Sears Installation Policy

All installation labor arranged by Sears shall be performed in a neat, workmanlike manner in accordance with generally accepted trade practices. Further, all installations shall comply with all local laws, codes regulations and ordinances. The customer shall also be protected, during installation, by insurance relating to property damage, Worker's Compensation and Public Liability.

If you want this water heater professionally installed by Sears contact your Salesperson. They will arrange for prompt, quality installation by Sears authorized contractors.



For in-home major brand repair service
Call 24 hours a day, 7 days a week
1-800-4-MY-HOME
(1-800-469-4663)

The model number of your water heater is found on the model rating plate on the front of the water heater.