



MANUAL AND USER GUIDE

Pocketalker® Pro
Personal Amplifier

PKT PRO Amplifier



OVERVIEW

The POCKETALKER® PRO is a versatile, high quality assistive listening device designed to improve communications in difficult listening situations. The POCKETALKER® PRO delivers clear, distinct sound, while its large, manageable control provides for easy operation.

Use the POCKETALKER® PRO to improve listening on a one-to-one basis, in small group situations, while listening to your favorite TV or radio programs, or while riding in the car.

The POCKETALKER® PRO is not sold, advertised, or intended for use as a personal hearing aid. Williams Sound recommends that any individual experiencing hearing loss be examined by a physician to determine the cause before using amplification.

CONTENTS

Safety Information	4
Recycling Information	7
Getting Started	8
Listening In Conversations	12
TV Listening	14
Using A Neckloop	16
Hints & Tips	18
Battery Information	20
Advanced Features	25
System Specifications	28
Acoustic Specifications	30
Accessories	33
Warranty	34

SAFETY INFORMATION

Hearing Safety:



CAUTION!

This product is designed to amplify sounds to a high volume level which could potentially cause hearing damage if used improperly. **To protect your hearing and the hearing of others:**

1. Make sure the volume is turned down before putting on the earphone or headphone before adjusting the volume to a comfortable level.
2. Set the volume level at the minimum setting that you need to hear.
3. If you experience feedback (a squealing or howling sound), reduce the volume setting and move the microphone away from the earphone or headphone.

4. Do not allow children or other **unauthorized persons** to have access to this product.

Battery Safety and Disposal:



CAUTION!

This product is supplied with disposable Alkaline batteries. Do not attempt to recharge disposable batteries, which may explode, release dangerous chemicals, cause burns, or other serious harm to the user or product.

Pacemaker Safety:



1. **Before** using this product with a pacemaker or other medical device, consult your physician or the manufacturer of your pacemaker or other medical device.
2. If you have a pacemaker or other medical device, make sure that you are using this product in accordance with safety guidelines established by your physician or the pacemaker manufacturer.

RECYCLING INSTRUCTIONS



Help Williams Sound protect the environment! Please take the time to dispose of your equipment properly.

Product Recycling for Customers in the European Union:

Please do NOT dispose of your Williams Sound equipment in the household trash. Please take the equipment to an electronics recycling center; OR, return the product to the factory for proper disposal.

Battery Recycling for Customers in the European Union:

Please do NOT dispose of used batteries in the household trash. Please take the batteries to a retail or community collection point for recycling.

8/15/06

GETTING STARTED

1. Open the battery compartment using a coin in the slot in the bottom of the POCKETALKER® PRO.
2. Press 2 AA batteries into place, being careful to observe correct placement of (+) and (-) terminals.

BATTERY INSTALLATION

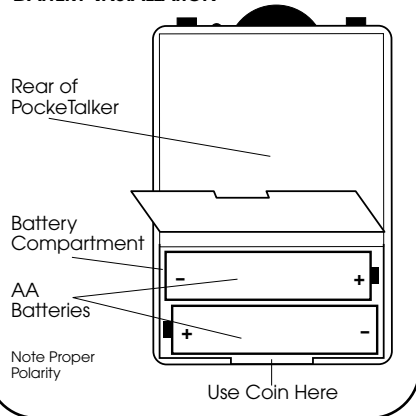

POCKETALKER® PRO CONTROL PANEL

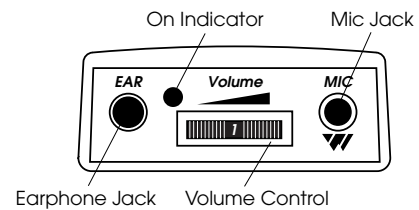

If you're using rechargeable batteries, they *must* be charged before use. See *Battery Information* on page 20.

The POCKETALKER® PRO can also be operated using the optional TFP 008 charger/power supply. If you're using the optional charger/power supply, make sure *only* rechargeable batteries are installed.

3. Plug the microphone into the "MIC" jack and the earphone or

headphone into the “EAR” jack.
Your POCKETALKER® PRO system comes with either the Mini Earphone (EAR 013), Wide Range Earphone (EAR 008), Lightweight Headphone (HED 021), or Rear-Wear Headphone (HED 026).

4. Put on the earphone or headphone.
5. Turn on the POCKETALKER® PRO by turning the Volume Control. The green “on” indicator light should be lit.
6. Adjust the volume according to your preferences.

POCKETALKER® PRO SET-UP

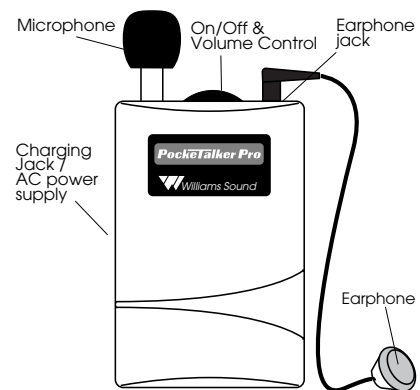

LISTENING IN CONVERSATIONS

The POCKETALKER® PRO picks up sounds and boosts them according to the volume you've set. *For best results, place or hold the POCKETALKER® PRO's microphone as close as possible to the person with whom you're speaking.*

SEATED

Many users set the POCKETALKER® PRO on a table if they're in a restaurant or small group situation. Laying the POCKETALKER® PRO flat on the table surface provides superior pickup to standing the POCKETALKER® PRO upright.

STANDING OR WALKING

Many users place the POCKETALKER® PRO in its Belt Clip Carry Case and attach it to their belt, pocket, or skirt.

IN THE CAR

For conversations in the car, you can use the optional microphone extension cord (WCA 063 or WCA 007) and optional Lapel Clip (MIC 054) to attach the mic to the shirt or blouse of your fellow rider.

ON THE TELEPHONE

The POCKETALKER® PRO can be used with the optional TELELINK™ Phone Coupler (TEL 001) for listening to phone conversations at a clear and comfortable volume. See the instructions (MAN 020) which come with the TELELINK.

TV LISTENING

For TV listening, the POCKETALKER® PRO uses the optional 12 foot extension cord (WCA 007 WC) to extend the earphone or mic cord. To use the POCKETALKER® PRO for TV listening:

1. Unplug the microphone from the top of the unit and plug it into the optional extension cord. Arrange the cord to reach the loudspeaker of the TV and plug the other end into the POCKETALKER® PRO.

EXTENDING THE MIC FOR TV LISTENING

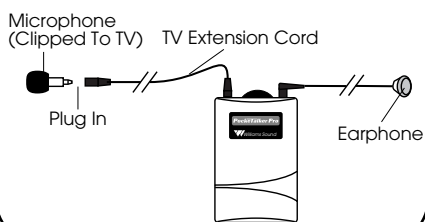

PLACEMENT OF MIC CLIP ON TV

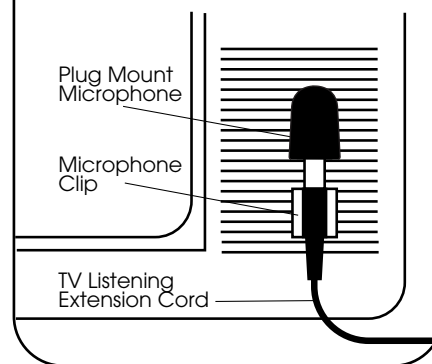

2. Attach one of the self-adhesive plastic clips to the TV, near the loudspeaker, as shown in the illustration.
3. Press the microphone into the plastic clip.
4. Turn on the TV and the POCKETALKER® PRO. Adjust the volume on both as needed.

USING A NECKLOOP

Williams Sound's optional neckloop telecoil couplers magnetically couple the audio output from the POCKETALKER® PRO into a hearing aid equipped with a telephone coil.

The neckloop (NKL 001) works only with hearing aids equipped with a telephone coil (T-Switch).

HOW TO USE THE NECKLOOP

1. Place the neckloop over your head and around your neck.
2. Slide the bead upwards to a comfortable position. This helps keep the neckloop in optimal position for coupling with your hearing aid.
3. Plug the neckloop into the earphone jack on the POCKETALKER® PRO.

USING THE NECKLOOP

Slide the bead upwards to a comfortable position.

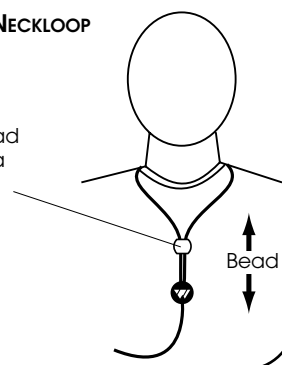

4. Turn the POCKETALKER® PRO on and set the volume control to “3”, or about half of full volume.
5. Turn the switch on your hearing aid to the “T” position and adjust the volume for comfortable listening.
6. If the sound is weak, increase the volume on the POCKETALKER® PRO, then on your hearing aid.

HINTS & TIPS

The POCKETALKER® PRO has been designed to be as easy to use as possible. However, if you have trouble, check the following:

1. Make sure the microphone is plugged into the “MIC” jack and the earphone or headphone is plugged into the “EAR” jack.
2. Make sure the batteries are not depleted and have been inserted correctly into the battery compartment.
3. If rechargeable, make sure the batteries are sufficiently charged.
4. If you experience a howling or squealing sound, this is called feedback. Depending on the earphone or headphone used, you can sometimes get feedback when the volume control is turned higher than 3 or 3½.

To eliminate feedback, turn down the volume control or move the microphone further away from the earphone or headphone.

5. The POCKETALKER® PRO earphone jack is a mono jack, designed for mono earphones and headphones. If you use stereo earphones or headphones with the POCKETALKER® PRO, only one side of the headphones will work.
6. If the steps above don't solve the problem, contact your Williams Sound Dealer for further instructions.

BATTERY INFORMATION

The POCKETALKER® PRO operates on either two (2) standard AA alkaline batteries, two (2) NiMH AA rechargeable batteries, or the optional 3V Charger.

INSTALLING BATTERIES

1. Open the battery compartment using a coin in the slot in the bottom of the POCKETALKER® PRO.
2. Press 2 AA batteries into place over the black ribbon. Be careful to observe correct placement of the (+) and (-) terminals.
3. Close the battery compartment by pressing the lid shut.

BATTERY INSTALLATION

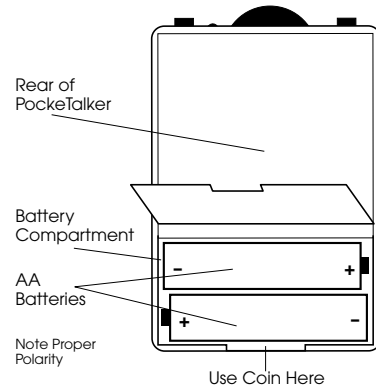

USING RECHARGEABLE BATTERIES

The optional Rechargeable Battery Kit (BAT KT3) helps you operate your POCKETALKER® PRO more economically.

Note: The BAT KT3 is only available for 110 VAC mains power (North America).

The kit includes two (2) NiMH AA rechargeable batteries and a 3V charger.

These batteries are shipped in a discharged state and must be charged for 18 hours before using.

1. Install the two (2) NiMH batteries according to the steps on page 20.
2. Make sure the POCKETALKER® PRO is turned off.
3. Plug the charger into the charging jack on the side panel of the POCKETALKER® PRO.

RECHARGEABLE BATTERY KIT SETUP

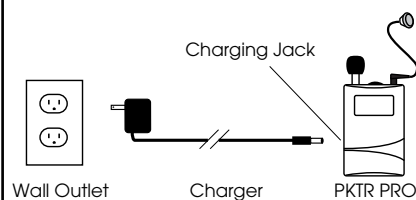

4. Plug the charger into a wall outlet.

The indicator light on the POCKETALKER® PRO will glow red while charging. Batteries should be fully charged in about 18 hours.

WARNING:

Do not attempt to recharge disposable batteries!

USING THE POCKETALKER® PRO WITHOUT BATTERIES

To extend battery life, you may operate the POCKETALKER® PRO from the charger.

Because the charger must be plugged into a wall outlet, this is practical when mobility is not important—for instance, while watching TV.

1. Remove any non-rechargeable batteries from the POCKETALKER® PRO. Rechargeable batteries may be left in.
2. Plug the charger into the charging jack on the side panel of the POCKETALKER® PRO, then into a wall outlet.
3. Use the POCKETALKER® PRO as you would normally.

ADVANCED FEATURES

TONE & GAIN CONTROL ADJUSTMENTS

It may not be necessary to adjust tone and gain controls. If it does prove necessary, it's best to have your audiologist perform the adjustments.

1. Open the battery compartment using a coin in the slot in the bottom of the POCKETALKER® PRO.
2. Pull up and out on battery door to open the back of the case.
3. See the diagram on the following page for Gain and Tone Control locations.
4. Use a small screwdriver or PLT 005 Tuning Wand to rotate the controls.

LOCATION OF TONE & GAIN CONTROLS

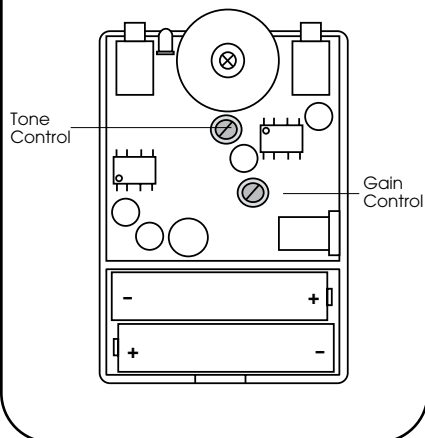

GAIN CONTROL

Adjusting the Gain Control modifies maximum amplification levels to match your hearing ability.

Turning the gain control fully counter-clockwise reduces the gain

to 25 dB max. Turning the gain control fully clockwise boosts the gain to 49 dB max. This results in 135 dB maximum SSPL with the EAR 013.

TONE CONTROL

The Tone Control lets you boost high frequency gain.

Turning the tone control fully clockwise boosts the HF gain by 10 dB at 5 kHz. Turning the tone control fully counter-clockwise provides flat response.

5. Close back of the case and battery door.

POCKETALKER® PRO SPECIFICATIONS

POCKETALKER® PRO PERSONAL AMPLIFIER, MODEL PKT C1

Dimensions:	3-5/8"L x 2-3/8"W x 7/8" H (92.1mm x 60.3mm x 22.2mm)
Weight:	3.8 oz (110 g) with battery
Color & Material:	Gray, shatter-proof polypropylene
Battery Type:	1.5V (AA) x 2 Alkaline (BAT 001) or Rechargeable AA NiMH (BAT 026)
Battery Life:	100 hours with alkaline batteries (BAT 001), 40 hours/charge with rechargeable batteries (BAT 026), 8 mA, nom. current drain
Microphone:	Omnidirectional condenser, plug- mount-type, 3.5 mm mini phone plug
Earphone:	3 Styles: mini earphone, wide range earphone, and lightweight head- phone All have dynamic, wide-range Samarium-Cobalt magnets, 39" (1m) cords, 3.5 mm mini phone plugs (mono), 32 Ohm

Controls:	Volume: rotary on/off/volume control; Gain: Internal rotary maximum gain control (screwdriver adjust); 20-45 dB acoustic gain w/EAR 013; Tone: Internal rotary tone control (screwdriver adjust); +17 dB at 16 kHz at max setting Microphone Connector: 3.5 mm mini phone jack (mono)
Earphone Connector:	3.5 mm mini phone jack (mono)
Charging Jack:	External side jack, 2.1mm, Charger TFP 008 can also be used as power supply (battery eliminator)
Frequency Response:	50 Hz-16 kHz, +1 -4 dB (electrical response)
Max. Distortion:	.5%THD (electrical)
Max. Output Power:	125 mW into 16 Ohms (electrical)
Approvals:	CE, RoHS, WEEE
Warranty:	5 years, parts and labor (90 days on accessories)

NOTE:

The POCKETALKER® PRO is not sold, advertised, or intended for use as a personal hearing aid. Williams Sound recommends that any individual experiencing hearing loss be examined by a physician to determine the cause before using amplification.

ACOUSTIC SPECIFICATIONS

Measured With EAR 008
(PKTPRO1-1)/6cc Coupler

Maximum SSPL90:	114.7 dB at 1100 Hz
HF Avg SSPL90:	107.5 dB
HF Avg Full On Gain:	26.1 dB at 60 dB in
Reference Test Gain:	26.2 dB
Response Limit:	66.3 dB F1=200 Hz, F2=8 kHz
Total Harmonic Dist:	0.2% at 500 Hz 0.2% at 800 Hz 0.4% at 1600 Hz

Gain Control Curve

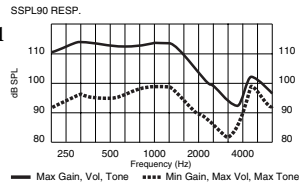

Tone Control Curve

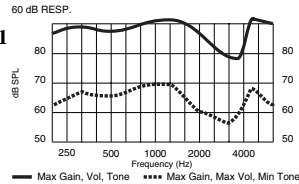

Measured With EAR 013
(PKT PRO1-2)/2cc Coupler

Maximum SSPL90:	131.9 dB at 500 Hz
HF Avg SSPL90:	124.7 dB
HF Avg Full On Gain:	44.1 dB at 60 dB in
Reference Test Gain:	44.1 dB
Response Limit:	84.2 dB, F1=200 Hz, F2=8 kHz
Total Harmonic Distortion:	1.8% at 500 Hz 0.3% at 800 Hz 0.3% at 1600 Hz

Gain Control Curve

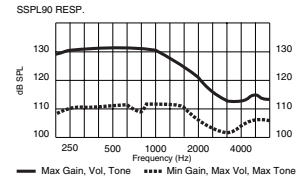

Tone Control Curve

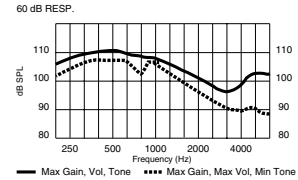

Measured With HED 021
(PKT PRO1-3)/6cc Coupler

Maximum SSPL90:	128.0 dB at 1800 Hz
HF Avg SSPL90:	124.4 dB
HF Avg Full On Gain:	42.2 dB at 60 dB in
Reference Test Gain:	42.3 dB
Response Limit:	82.6 dB, F1=200 Hz, F2=8 kHz
Total Harmonic Distortion:	3.8% at 500 Hz 1.3% at 800 Hz 0.9% at 1600 Hz

Gain Control Curve

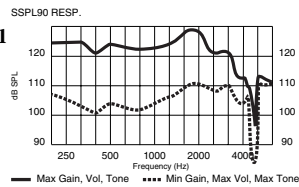

Tone Control Curve

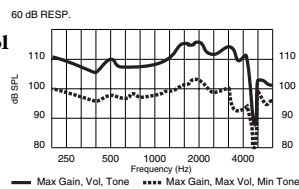

ACCESSORIES

To order replacement accessories or optional products, contact your dealer or Williams Sound Corp. at 1-800-843-3544.

<u>ACCESSORY</u>	<u>PART #</u>
Rechargeable Battery Kit	BAT KT3 (2 AA NiMH Batteries & Charger)
Plug Mount Microphone	MIC 014
TV Listening Extension Cord (12')	WCA 007 WC
Short Microphone Cord (39")	WCA 063
Plastic Mic Clip	PLC 004
Mic Lapel Clip	MIC 060
Mic Windscreen	WND 002
Belt Clip Case (Black Vinyl)	CCS 001
System Case (Soft Nylon , Blue)	CCS 020
Belt Clip System Case (Black Vinyl)	CCS 008
Telelink® Phone Coupler	TEL 001
Neckloop Telecoil Coupler	NKL 001
Wide Range Earphone	EAR 008
Mini Earphone (earbud)	EAR 013
Lightweight Headphones	HED 021
Rear-Wear Headphone	HED 026

LIMITED WARRANTY

Williams Sound products are engineered, designed and manufactured under carefully controlled conditions to provide you with many years of reliable service. Williams Sound warrants the POCKETALKER® PRO Amplifier against defects in materials and workmanship for FIVE (5) years. During the first five years from the purchase date, we will promptly repair or replace the POCKETALKER® PRO Amplifier.

Microphones, earphones, headphones, batteries, chargers, cables, carry cases, and all other accessory products carry a 90-day warranty.

WILLIAMS SOUND HAS NO CONTROL OVER THE CONDITIONS UNDER WHICH THIS PRODUCT IS USED. WILLIAMS SOUND, THEREFORE, DISCLAIMS ALL WARRANTIES NOT SET FORTH ABOVE, BOTH EXPRESS AND IMPLIED, WITH RESPECT TO THE POCKETALKER® PRO AMPLIFIER, INCLUDING BUT NOT LIMITED TO, ANY IMPLIED WARRANTY OF MERCHANTABILITY OR FITNESS FOR A

WILLIAMS SOUND SHALL NOT BE LIABLE TO ANY PERSON OR ENTITY FOR ANY MEDICAL EXPENSES OR ANY DIRECT, INCIDENTAL OR CONSEQUENTIAL DAMAGES CAUSED BY ANY USE, DEFECT, FAILURE OR MALFUNCTION OF THE PRODUCT, WHETHER A CLAIM FOR SUCH DAMAGES IS BASED UPON WARRANTY, CONTRACT, TORT OR OTHERWISE. THE SOLE REMEDY FOR ANY DEFECT, FAILURE OR MALFUNCTION OF THE PRODUCT IS REPLACEMENT OF THE PRODUCT. NO PERSON HAS ANY AUTHORITY TO BIND WILLIAMS SOUND TO ANY REPRESENTATION OR WARRANTY WITH RESPECT TO THE POCKETALKER® PRO AMPLIFIER. UNAUTHORIZED REPAIRS OR MODIFICATIONS WILL VOID THE WARRANTY.

The exclusions and limitations set out above are not intended to, and should not be construed so as to contravene mandatory provisions of applicable law. If any part or term of this Disclaimer of Warranty is held to be illegal, unenforceable or in conflict with applicable law by a court of competent jurisdiction, the validity of the remaining portions of this Disclaimer of Warranty shall not be affected, and all

rights and obligations shall be construed and enforced as if this Limited Warranty did not contain the particular part or term held to be invalid.

If you experience difficulty with your system, call Toll-Free for Customer Assistance:

1-800-843-3544

If it is necessary to return the system for service, your Customer Service Representative will give you a Return Authorization Number (RA) and shipping instructions.

Pack the system carefully and send it to:

**Williams Sound Corp.
Attn: Repair Dept.
10321 West 70th Street
Eden Prairie, MN 55344**

POCKETALKER® PRO
Components

- POCKETALKER® PRO Amplifier (PKT C1)
- Choice of:
 - Mini Earphone (EAR 013)
 - Wide Range Earphone (EAR 008)
 - Lightweight Headphone (HED 021)
 - Rear-Wear Headphone (HED 026)
- AA Alkaline batteries (2) (BAT 001)
- Plug Mount Mic (MIC 014)
- Optional TV Listening Extension Cord (WCA 007)
- Belt Clip Case (CCS 001)
- System Carry Case (CCS 008)
- Instruction Manual

