



User Manual

Read and understand this manual before using machine.

8" GRANITE JOINTER

**Model Number
40660 & 40655**

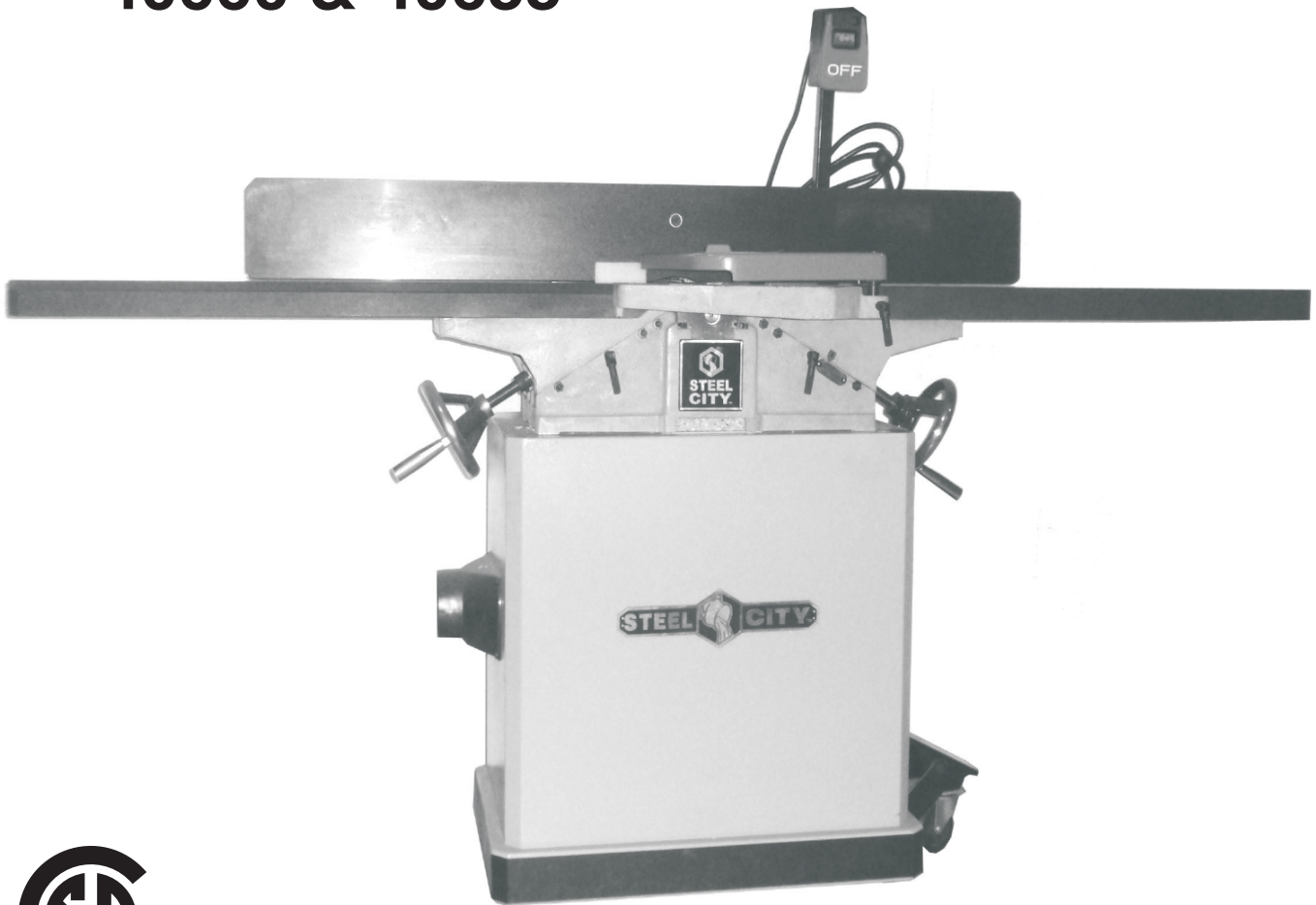

STEEL CITY TOOL WORKS
VER. 02.09

Manual Part No. OR74493

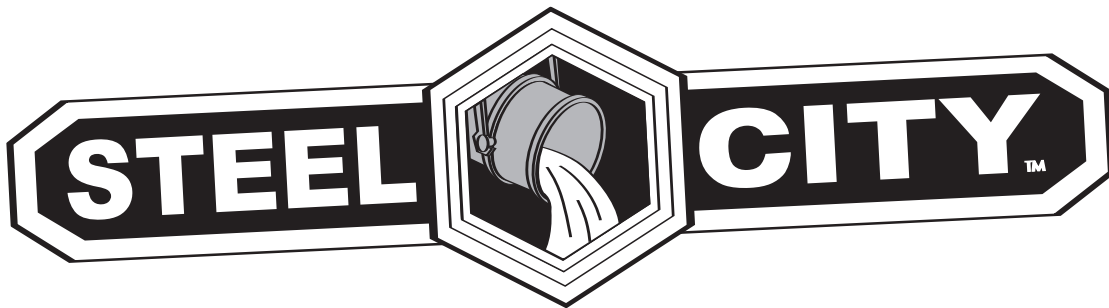

THANK YOU for purchasing your new Steel City Jointer. This jointer has been designed, tested, and inspected with you, the customer, in mind. When properly used and maintained, your jointer will provide you with years of trouble free service, which is why it is backed by one of the longest machinery warranties in the business.

This jointer is just one of many products in the Steel City's family of woodworking machinery and is proof of our commitment to total customer satisfaction.

At Steel City we continue to strive for excellence each and every day and value the opinion of you, our customer. For comments about your jointer or Steel City Tool Works, please visit our web site at www.steelcitytoolworks.com .

TABLE OF CONTENTS

INTRODUCTION

SECTION 1	Warranty	4
SECTION 2	Product Specifications	7
SECTION 3	Accessories and Attachments	7
SECTION 4	Definition of Terms	8
SECTION 5	Feature Identification	9
SECTION 6	General Safety	10
SECTION 7	Product Safety	12
SECTION 8	Electrical Requirements	13
SECTION 9	Unpacking & Inventory	15
SECTION 10	Assembly	18
SECTION 11	Adjustments	23
SECTION 12	Operations	26
SECTION 13	Maintenance	29
SECTION 14	Troubleshooting	30
SECTION 15	Parts List	33

INTRODUCTION

This user manual is intended for use by anyone working with this machine. It should be kept available for immediate reference so that all operations can be performed with maximum efficiency and safety. Do not attempt to perform maintenance or operate this machine until you have read and understand the information contained in this manual.

The drawings, illustrations, photographs, and specifications in this user manual represent your machine at time of print. However, changes may be made to your machine or this manual at any time with no obligation to Steel City Tool Works.

WARRANTY

STEEL CITY TOOL WORKS 5 YEAR LIMITED WARRANTY

Steel City Tool Works, LLC (“SCTW”) warrants all “STEEL CITY TOOL WORKS” machinery to be free of defects in workmanship and materials for a period of 5 years from the date of the original retail purchase by the original owner. (Granite components are warranted for 10 years. Please inform SCTW within 30 days for any damages or defects on the Granite components found upon receipt of the products to qualify for the 10 year limited warranty. See the Granite warranty statement supplied with those products.) SCTW will repair or replace, at its expense and at its option, any SCTW machine, machine part, or machine accessory which in normal use has proven to be defective, provided that the customer returns the product, shipping prepaid, to an authorized service center with proof of purchase and provides SCTW with a reasonable opportunity to verify the alleged defect by inspection. Date code, which can be found on the original carton and machine body, must be provided to SCTW at the time of any warranty request made. This warranty does not apply to defects due directly or indirectly to misuse, abuse, negligence, accidents, or lack of maintenance, or to unauthorized repairs or alterations made or specifically authorized by anyone other than SCTW. Normal wear components are also excluded under this coverage. Every effort has been made to ensure that all SCTW machinery meets the highest quality and durability standards. We reserve the right to change specifications at any time due to our commitment to continuous improvement of the quality of our products.

EXCEPT AS SET FORTH ABOVE, SCTW MAKES NO EXPRESS OR IMPLIED REPRESENTATIONS OR WARRANTIES WITH RESPECT TO ITS MACHINERY, OR ITS CONDITION, MERCHANTABILITY, OR FITNESS FOR ANY PARTICULAR PURPOSE OR USE. SCTW FURNISHES THE ABOVE WARRANTIES IN LIEU OF ALL OTHER WARRANTIES, EXPRESS OR IMPLIED, INCLUDING THE WARRANTIES OF MERCHANTABILITY AND FITNESS FOR A PARTICULAR PURPOSE, WHICH ARE HEREBY SPECIFICALLY DISCLAIMED.

SCTW SHALL NOT BE LIABLE FOR ANY (A) SPECIAL, INDIRECT, INCIDENTAL, PUNITIVE OR CONSEQUENTIAL DAMAGES, INCLUDING WITHOUT LIMITATION LOSS OF PROFITS, ARISING FROM OR RELATED TO THIS WARRANTY, THE BREACH OF ANY AGREEMENT OR WARRANTY, OR THE OPERATION OR USE OF ITS MACHINERY, INCLUDING WITHOUT LIMITATION DAMAGES ARISING FROM DAMAGE TO FIXTURES, TOOLS, EQUIPMENT, PARTS OR MATERIALS, DIRECT OR INDIRECT LOSS CAUSED BY ANY OTHER PARTY, LOSS OF REVENUE OR PROFITS, FINANCING OR INTEREST CHARGES, AND CLAIMS BY ANY THIRD PERSON, WHETHER OR NOT NOTICE OF SUCH POSSIBLE DAMAGES HAS BEEN GIVEN TO SCTW; (B) DAMAGES OF ANY KIND FOR ANY DELAY BY OR FAILURE OF SCTW TO PERFORM ITS OBLIGATIONS UNDER THIS AGREEMENT; OR (C) CLAIMS MADE A SUBJECT OF A LEGAL PROCEEDING AGAINST SCTW MORE THAN ONE (1) YEAR AFTER SUCH CAUSE OF ACTION FIRST AROSE.

The validity, construction and performance of this Warranty and any sale of machinery by SCTW shall be governed by the laws of the Commonwealth of Pennsylvania, without regard to conflicts of laws provisions of any jurisdiction. Any action related in any way to any alleged or actual offer, acceptance or sale by SCTW, or any claim related to the performance of any agreement including without limitation this Warranty, shall take place in the federal or state courts in Allegheny County, Pennsylvania.

STEEL CITY TOOL WORKS

Tech Service
1-877-724-8665
Please have your Model No.
and Serial No. available

WARRANTY CARD

Name _____
 Street _____
 Apt. No. _____
 City _____ State _____ Zip _____
 Phone Number _____
 E-Mail _____

Product Description: _____
 Model No.: _____
 Serial No. _____

The following information is given on a voluntary basis and is strictly confidential.

1. Where did you purchase your STEEL CITY machine?
 Store: _____
 City: _____

2. How did you first learn of Steel City Tool Works?
 Advertisement Mail Order Catalog
 Web Site Friend
 Local Store Other _____

3. Which of the following magazines do you subscribe to?
 American Woodworker American How-To
 Cabinetmaker Family Handyman
 Fine Homebuilding Fine Woodworking
 Journal of Light Construction Old House Journal
 Popular Mechanics Popular Science
 Popular Woodworking Today's Homeowner
 WOOD Woodcraft
 WOODEN Boat Woodshop News
 Woodsmith Woodwork
 Woodworker Woodworker's Journal
 Workbench Other _____

4. Which of the following woodworking / remodeling shows do you watch?
 Backyard America The American Woodworker
 Home Time The New Yankee Workshop
 This Old House Woodwright's Shop
 Other _____

5. What is your annual household income?
 \$20,000 to \$29,999 \$30,000 to \$39,999
 \$40,000 to \$49,999 \$50,000 to \$59,999
 \$60,000 to \$69,999 70,000 to \$79,999
 \$80,000 to \$89,999 \$90,000 +

6. What is your age group?
 20 to 29 years 30 to 39 years
 40 to 49 years 50 to 59 years
 60 to 69 years 70 + years

7. How long have you been a woodworker?
 0 to 2 years 2 to 8 years
 8 to 20 years over 20 years

8. How would you rank your woodworking skills?
 Simple Intermediate
 Advance Master Craftsman

9. How many Steel City machines do you own? _____

10. What stationary woodworking tools do you own?
Check all that apply.
 Air Compressor Band Saw
 Drill Press Drum Sander
 Dust Collection Horizontal Boring Machine
 Jointer Lathe
 Mortiser Panel Saw
 Planer Power Feeder
 Radial Arm Saw Shaper
 Spindle Sander Table Saw
 Vacuum Veneer Press Wide Belt Sander
 Other _____

11. Which benchtop tools do you own? *Check all that apply.*
 Belt Sander Belt / Disc Sander
 Drill Press Band Saw
 Grinder Mini Jointer
 Mini Lathe Scroll Saw
 Spindle / Belt Sander Other _____

12. Which portable / hand held power tools do you own?
Check all that apply.
 Belt Sander Biscuit Jointer
 Dust Collector Circular Saw
 Detail Sander Drill / Driver
 Miter Saw Orbital Sander
 Palm Sander Portable Thickness Planer
 Saber Saw Reciprocating Saw
 Router Other _____

13. What machines / accessories would you like to see added to the STEEL CITY line?

14. What new accessories would you like to see added?

15. Do you think your purchase represents good value?
 Yes No

16. Would you recommend STEEL CITY products to a friend?
 Yes No

17. Comments:

CUT HERE

FOLD ON DOTTED LINE

PLACE
STAMP
HERE

Steel City Tool Works
3656 Enterprise Avenue
Hayward, CA 94545

FOLD ON DOTTED LINE

WARRANTY

STEEL CITY TOOL WORKS EXCLUSIVE SUPPLIER OF WOODWORKING MACHINERY WITH GRANITE WORK SURFACE COMPONENTS

10 YEAR LIMITED WARRANTY ON GRANITE COMPONENTS

Steel City Tool Works takes great pride in the innovative development of solid GRANITE work surface components for woodworking machinery. Its consistent flatness, stability, and ease of care compared to other more common work surfaces, are major advantages to woodworkers.

GRANITE is a natural resource, quarried and processed for use in our machines. Because of its natural state, you will find some inconsistencies in the appearance of the material. This is common and should be expected. It makes each machine we produce unique.

Because it is the most consistent throughout the slab, we use only the black variety of GRANITE. Our goal is to provide you with the strongest, most stable work surface available. GRANITE is also easy to maintain with an annual application of a granite sealer, available in many specialty, home improvement or retail outlets.

To support our belief that you will find Steel City's GRANITE as strong, stable and reliable as we have, we offer the following 10 YEAR LIMITED WARRANTY on all GRANITE components. This warranty is offered in conjunction with our standard 5 YEAR LIMITED WARRANTY on all other machine components and parts.

STEEL CITY 10 YEAR WARRANTY ON GRANITE COMPONENTS

Steel City Tool Works, LLC (SCTW) warrants all granite components of your "Steel City Tool Works" machine to be free from defects of workmanship and materials for a full ten (10) years from the date of the original retail purchase by the original owner. SCTW will repair or replace, at its option and expense, any Steel City granite component which, in normal use, has proven to be defective, provided that the customer returns the component, shipping prepaid, to an authorized service facility with proof of purchase and provides SCTW with a reasonable opportunity to inspect and verify the alleged defect. This warranty does not apply to defects due directly or indirectly to misuse, abuse, negligence, accidents, or to repairs or alterations made or specifically authorized by any party other than SCTW. Granite components which are cracked, broken, or chipped significantly enough to interfere with the operation of the machine or the processing of material are covered by this limited warranty.

See the SCTW 5 Year Limited Warranty that provides the other terms and conditions of this 10 year granite warranty .

PRODUCT SPECIFICATIONS

Motor Specifications:

Type	TEFC Induction, Ball Bearing
Continuous Duty	
Horsepower	2 HP
Amps	7.5
Voltage	230
Phase	Single
Hertz	60
RPM	3450 (no load)

Product Specifications:

Footprint	24" x 22"
Length	75-1/2"
Width	23-1/2"
Height	41"
Total Net Weight	460 lbs

Product Dimensions:

Table	8" x 75-1/2"
Number of Knives (Helical Cutterhead)	16
Number of Knives (Straight Cutterhead)	3
Cutterhead Diameter	3-1/4"
Cutterhead Speed	5,000 RPM
Cuts per Minute (Helical Cutterhead)	80000
Cuts per Minute (Straight Cutterhead)	15000
Fence Size Overall	5-1/2" x 48"
Maximum Depth of cut	1/2"
Maximum Depth of rabbet	1/2"

Shipping Dimensions:

JOINTER

Carton Type	Wooden Crate
Length	79"
Weight	25-1/2"
Height	15"
Gross Weight	414 lbs.

STAND

Carton Type	Cardboard Box
Length	28"
Width	23-1/2"
Height	17-1/2"
Gross Weight	134 lbs.

ACCESSORIES AND ATTACHMENTS

There are a variety of accessories available for your Steel City Product. For more information on any accessories associated with this and other machines, please contact your nearest Steel City distributor, or visit our website at: www.steelcitytoolworks.com.

DEFINITION OF TERMS

Edge Jointing: The process of making the edge of a piece of stock straight and square

Face Jointing: Similar to edge jointing except rather than the edge it is the face of the board that is being machined flat and square.

Gum, Pitch or Resin: A sticky sap based residue that comes from wood products.

Rabbet: A rectangular cut or groove along or near the edge of a piece of wood that allows another piece to fit into it to form a joint

Snipe: Gouging or depression of the board at the Ends. Snipe can occur either at the beginning of the board going into the jointer or at the end of the board as it comes out of the jointer.

FEATURE IDENTIFICATION

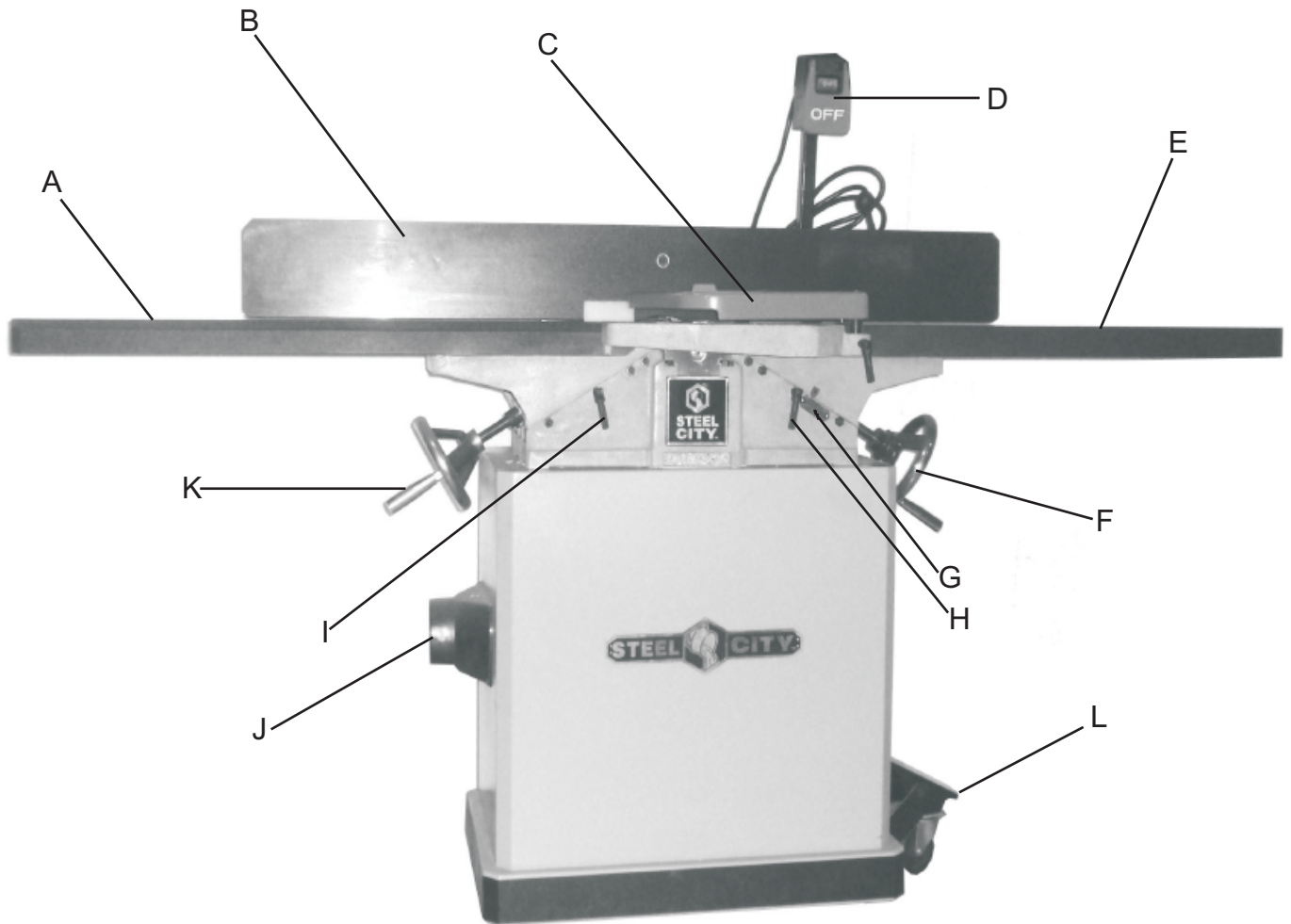

- A. DUST PORT
- B. FENCE
- C. CUTTERHEAD GUARD
- D. POWER SWITCH
- E. INFEED TABLE
- F. INFEED TABLE RAISE/LOWER HANDWHEEL
- G. DEPTH SCALE
- H. INFEED TABLE LOCK HANDLE
- I. OUTFEED TABLE LOCK HANDLE
- J. DUST PORT
- K. INFEED TABLE RAISE/LOWER HANDWHEEL
- L. MOBILE BASE FOOT PEDAL

GENERAL SAFETY

⚠ WARNING

TO AVOID serious injury and damage to the machine, read and follow all Safety and Operating Instructions before assembling and operating this machine.

This manual is not totally comprehensive. It does not and can not convey every possible safety and operational problem which may arise while using this machine. The manual will cover many of the basic and specific safety procedures needed in an industrial environment.

All federal and state laws and any regulations having jurisdiction covering the safety requirements for use of this machine take precedence over the statements in this manual. Users of this machine must adhere to all such regulations.

Below is a list of symbols that are used to attract your attention to possible dangerous conditions.



This is the safety alert symbol. It is used to alert you to potential personal injury hazards. Obey all safety messages that follow this symbol to avoid possible injury or death.

⚠ DANGER

Indicates an imminently hazardous situation which, if not avoided, **WILL** result in death or serious injury.

⚠ WARNING

Indicates a potentially hazardous situation which, if not avoided, **COULD** result in death or serious injury.

⚠ CAUTION

Indicates a potentially hazardous situation, if not avoided, **MAY** result in minor or moderate injury. It may also be used to alert against unsafe practices.

CAUTION

CAUTION used without the safety alert symbol indicates a potentially hazardous situation which, if not avoided, may result in property damage.

NOTICE

This symbol is used to alert the user to useful information about proper operation of the machine.

⚠ WARNING

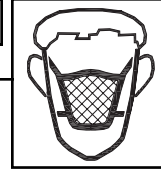

Exposure to the dust created by power sanding, sawing, grinding, drilling and other construction activities may cause serious and permanent respiratory or other injury, including silicosis (a serious lung disease), cancer, and death. Avoid breathing the dust, and avoid prolonged contact with dust. The dust may contain chemicals known to the State of California to cause cancer, birth defects or other reproductive harm.

Some examples of these chemicals are:

- Lead from lead-based paints.
- Crystalline silica from bricks, cement and other masonry products.
- Arsenic and chromium from chemically-treated lumber.

Always operate tool in well ventilated area and provide for proper dust removal. Use a dust collection system along with an air filtration system whenever possible. Always use properly fitting NIOSH/OSHA approved respiratory protection appropriate for the dust exposure, and wash exposed areas with soap and water.

1. To avoid serious injury and damage to the machine, read the entire User Manual before assembly and operation of this machine.

⚠ WARNING

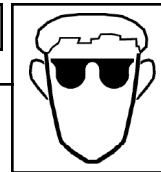

2. **ALWAYS** wear eye protection. Any machine can throw debris into the eyes during operations, which could cause severe and permanent eye damage. Everyday eyeglasses are **NOT** safety glasses. **ALWAYS** wear Safety Goggles (that comply with ANSI standard Z87.1) when operating power tools.

▲ WARNING

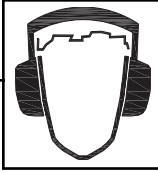

3. **ALWAYS** wear hearing protection. Plain cotton is not an acceptable protective device. Hearing equipment should comply with ANSI S3.19 Standards.

▲ WARNING

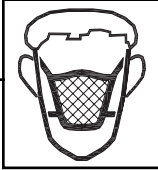

4. **ALWAYS** wear a NIOSH/OSHA approved dust mask to prevent inhaling dangerous dust or airborne particles.

5. **ALWAYS** keep the work area clean, well lit, and organized. **DO NOT** work in an area that has slippery floor surfaces from debris, grease, and wax.
6. **ALWAYS** unplug the machine from the electrical receptacle when making adjustments, changing parts or performing any maintenance.
7. **AVOID ACCIDENTAL STARTING.** Make sure that the power switch is in the "OFF" position before plugging in the power cord to the electrical receptacle.

▲ WARNING

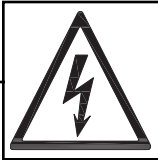

8. **AVOID** a dangerous working environment. **DO NOT** use electrical tools in a damp environment or expose them to rain or moisture.

▲ WARNING

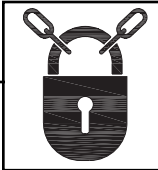

9. **CHILDPROOF THE WORKSHOP AREA** by removing switch keys, unplugging tools from the electrical receptacles, and using padlocks.

10. **DO NOT** use electrical tools in the presence of flammable liquids or gasses.

11. **DO NOT FORCE** the machine to perform an operation for which it was not designed. It will do a safer and higher quality job by only performing operations for which the machine was intended.
12. **DO NOT** stand on a machine. Serious injury could result if it tips over or you accidentally contact any moving part.
13. **DO NOT** store anything above or near the machine.
14. **DO NOT** operate any machine or tool if under the influence of drugs, alcohol, or medication.
15. **EACH AND EVERY** time, check for damaged parts prior to using any machine. Carefully check all guards to see that they operate properly, are not damaged, and perform their intended functions. Check for alignment, binding or breakage of all moving parts. Any guard or other part that is damaged should be immediately repaired or replaced.
16. Ground all machines. If any machine is supplied with a 3-prong plug, it must be plugged into a 3-contact electrical receptacle. The third prong is used to ground the tool and provide protection against accidental electric shock. **DO NOT** remove the third prong.
17. Keep visitors and children away from any machine. **DO NOT** permit people to be in the immediate work area, especially when the machine is operating.
18. **KEEP** protective guards in place and in working order.
19. **MAINTAIN** your balance. **DO NOT** extend yourself over the tool. Wear oil resistant rubber soled shoes. Keep floor clear of debris, grease, and wax.
20. **MAINTAIN** all machines with care. **ALWAYS KEEP** machine clean and in good working order. **KEEP** all blades and tool bits sharp.
21. **NEVER** leave a machine running, unattended. Turn the power switch to the OFF position. **DO NOT** leave the machine until it has come to a complete stop.
22. **REMOVE ALL MAINTENANCE TOOLS** from the immediate area prior to turning the machine ON.
23. **SECURE** all work. When it is possible, use clamps or jigs to secure the workpiece. This is safer than attempting to hold the workpiece with your hands.
24. **STAY ALERT**, watch what you are doing, and use common sense when operating any machine. **DO NOT** operate any machine tool while tired or under the influence of drugs, alcohol, or medication. A moment of inattention while operating power tools may result in serious personal injury.

25. **USE ONLY** recommended accessories. Use of incorrect or improper accessories could cause serious injury to the operator and cause damage to the machine. If in doubt, **DO NOT** use it.
26. **THE USE** of extension cords is not recommended for 230V equipment. It is better to arrange the placement of your equipment and the installed wiring to eliminate the need for an extension cord. If an extension cord is necessary, refer to the chart in the Grounding Instructions section to determine the minimum gauge for the extension cord. The extension cord must also contain a ground wire and plug pin.
27. Wear proper clothing, **DO NOT** wear loose clothing, gloves, neckties, or jewelry. These items can get caught in the machine during operations and pull the operator into the moving parts. Users must wear a protective cover on their hair, if the hair is long, to prevent it from contacting any moving parts.
28. **SAVE** these instructions and refer to them frequently and use them to instruct other users.
29. Information regarding the safe and proper operation of this tool is also available from the following sources:

Power Tool Institute
 1300 Summer Avenue
 Cleveland, OH 44115-2851
www.powertoolinstitute.org

National Safety Council
 1121 Spring Lake Drive
 Itasca, IL 60143-3201

American National Standards Institute
 25 West 43rd Street, 4th floor
 New York, NY 10036
www.ansi.org

ANSI 01.1 Safety Requirements for
 Woodworking Machines, and the U.S. Department
 of Labor regulations
www.osha.gov

PRODUCT SAFETY

1. Serious personal injury may occur if normal safety precautions are overlooked or ignored. Accidents are frequently caused by lack of familiarity or failure to pay attention. Obtain advice from supervisor, instructor, or another qualified individual who is familiar with this machine and its operations.
2. Every work area is different. Always consider safety first, as it applies to your work area. Use this machine with respect and caution. Failure to do so could result in serious personal injury and damage to the machine.

3. Prevent electrical shock. Follow all electrical and safety codes, including the National Electrical Code (NEC) and the Occupational Safety and Health Regulations (OSHA). All electrical connections and wiring should be made by qualified personnel only.

WARNING

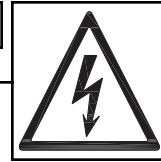

4. **TO REDUCE** the risk of electrical shock. **DO NOT** use this machine outdoors. **DO NOT** expose to rain or moisture. Store indoors in a dry area.

5. **STOP** using this machine, if at any time you experience difficulties in performing any operation. Contact your supervisor, instructor or machine service center immediately.
6. Safety decals are on this machine to warn and direct you to how to protect yourself or visitors from personal injury. These decals **MUST** be maintained so that they are legible. **REPLACE** decals that are not legible.
7. **DO NOT** leave the unit plugged into the electrical outlet. Unplug the unit from the outlet when not in use and before servicing, performing maintenance tasks, or cleaning.
8. **ALWAYS** turn the power switch "OFF" before unplugging the jointer.

WARNING

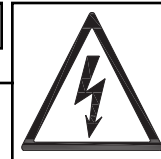

9. **DO NOT** handle the plug or jointer with wet hands.

10. **USE** accessories only recommended by Steel City.
11. **DO NOT** pull the jointer by the power cord. **NEVER** allow the power cord to come in contact with sharp edges, hot surfaces, oil or grease.
12. **DO NOT** unplug the jointer by pulling on the power cord. **ALWAYS** grasp the plug, not the cord.
13. **REPLACE** a damaged cord immediately. **DO NOT** use a damaged cord or plug. If the jointer is not operating properly, or has been damaged, left outdoors or has been in contact with water.
14. **DO NOT** use the jointer as a toy. **DO NOT** use near or around children.

15. **ENSURE** that the machine sits firmly on the floor before using. If the machine wobbles or is unstable, correct the problem by using shims or blocks prior to operation.
16. **ALWAYS** keep hands and fingers away from the blades when operating.
17. **USE** push blocks on any materials less than 3" in height or thickness.
18. **DO NOT** use the jointer on pieces less than 10" in length.
19. **NEVER** use the jointer with the depth of cut at more than 1/8".
20. **MAINTAIN** the proper relationship between the infeed and outfeed tables and the cutterhead knives.
21. **NEVER** remove any chips without turning off the machine and disconnecting the power.
22. **NEVER** turn on the machine if the workpiece is in contact with the cutterhead.
23. **ALWAYS** feed against the rotation of the cutterhead. Never apply feed pressure with your hands directly over the cutterhead. Always lift your hands, one at a time, over the cutterhead as you pass the work along the jointer bed. Always support the workpiece and maintain control throughout the operation.
24. **KEEP** cutterhead knives sharp and free of all rust and pitch.
25. **ALWAYS** disconnect the machine from the power source before making any adjustments.
26. **NEVER** perform "free hand" operations. Use the fence to position and guide the workpiece.

ELECTRICAL REQUIREMENTS

WARNING

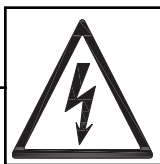

To reduce the risk of electric shock, follow all electrical and safety codes, including the National Electric Code (NEC) and the Occupational Safety and Health Regulations (OSHA). All electrical connections and wiring should be made by qualified personnel only.

The switch provided with your jointer is designed for 230 volt single phase usage only. The switch has a plug that is designed to plug into a 230 volt outlet. There are many different configurations for 230 volt outlets, so it is conceivable that the configuration of the plug may not match the configuration of your existing outlet. If this is the case, you will have to replace the plug with a UL/CSA approved plug that matches the configuration of your 230V outlet.

GROUNDING INSTRUCTIONS

⚠ WARNING



This machine **MUST BE GROUNDED** while in use to protect the operator from electric shock.

In the event of a malfunction or breakdown, **GROUNDING** provides the path of least resistance for electric current and reduces the risk of electric shock. The plug **MUST** be plugged into a matching electrical receptacle that is properly installed and grounded in accordance with **ALL** local codes and ordinances.

If a plug is provided with your machine **DO NOT** modify the plug. If it will not fit your electrical receptacle, have a qualified electrician install the proper connections to meet all electrical codes local and state. All connections must also adhere to all of OSHA mandates.

IMPROPER ELECTRICAL CONNECTION of the equipment-grounding conductor can result in risk of electric shock. The conductor with the green insulation (with or without yellow stripes) is the equipment-grounding conductor. **DO NOT** connect the equipment-grounding conductor to a live terminal if repair or replacement of the electric cord or plug is necessary.

Check with a qualified electrician or service personnel if you do not completely understand the grounding instructions, or if you are not sure the tool is properly grounded.

PLUGS/RECEPTACLES

⚠ WARNING



- Electrocution or fire could result if this machine is not grounded properly or if the electrical configuration does not comply with local and state electrical codes.
- **MAKE CERTAIN** the machine is disconnected from power source before starting any electrical work.
- **MAKE SURE** the circuit breaker does not exceed the rating of the plug and receptacle.

The motor supplied with your machine is a 230 volt, 60 hertz, single phase motor. Never connect the green or ground wire to a live terminal.

A machine with a 230 volt plug should only be connected to an outlet having the same configuration as the plug.

EXTENSION CORDS

⚠ WARNING

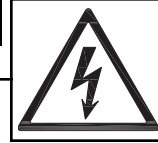

To reduce the risk of fire or electrical shock, use the proper gauge of extension cord. When using an extension cord, be sure to use one heavy enough to carry the current your machine will draw.

The smaller the gauge-number, the larger the diameter of the extension cord is. If in doubt of the proper size of an extension cord, use a shorter and thicker cord. An undersized cord will cause a drop in line voltage resulting in a loss of power and overheating.

⚠ CAUTION

USE ONLY a 3-wire extension cord that has a 3-prong grounding plug and a 3-pole receptacle that accepts the machine's plug.

If you are using an extension cord outdoors, be sure it is marked with the suffix "W-A" ("W" in Canada) to indicate that it is acceptable for outdoor use.

Make certain the extension cord is properly sized, and in good electrical condition. Always replace a worn or damaged extension cord immediately or have it repaired by a qualified person before using it.

Protect your extension cords from sharp objects, excessive heat, and damp or wet areas.

MINIMUM RECOMMENDED GAUGE FOR EXTENSION CORDS (AWG)

230 VOLT OPERATION ONLY			
	25' LONG	50' LONG	100' LONG
0 to 6 Amps	16 AWG	16 AWG	14 AWG
6 to 8 Amps	16 AWG	16 AWG	12 AWG
8 to 12 Amps	14 AWG	14 AWG	10 AWG
12 to 15 Amps	12 AWG	12 AWG	10 AWG
15 to 20 Amps	10 AWG	10 AWG	Not recommended

UNPACKING & INVENTORY

⚠ WARNING



- The machine is heavy, two people are required to unpack and lift.
- Use a safety strap to avoid tip over when lifting machine.

Check shipping carton and machine for damage before unpacking. Carefully remove packaging materials, parts and machine from shipping carton. Always check for and remove protective shipping materials around motors and moving parts. Lay out all parts on a clean work surface.

Remove any protective materials and coatings from all

of the parts and the jointer. The protective coatings can be removed by spraying WD-40 on them and wiping it off with a soft cloth. This may need to be redone several times before all of the protective coatings are removed completely.

After cleaning, apply a good quality paste wax to any unpainted surfaces. Make sure to buff out the wax before assembly.

Compare the items to inventory figures; verify that all items are accounted for before discarding the shipping box.

⚠ WARNING

If any parts are missing, do not attempt to plug in the power cord and turn "ON" the machine. The machine should only be turned "ON" after all the parts have been obtained and installed correctly. For missing parts, contact Steel City at 1-877-SC4-TOOL.

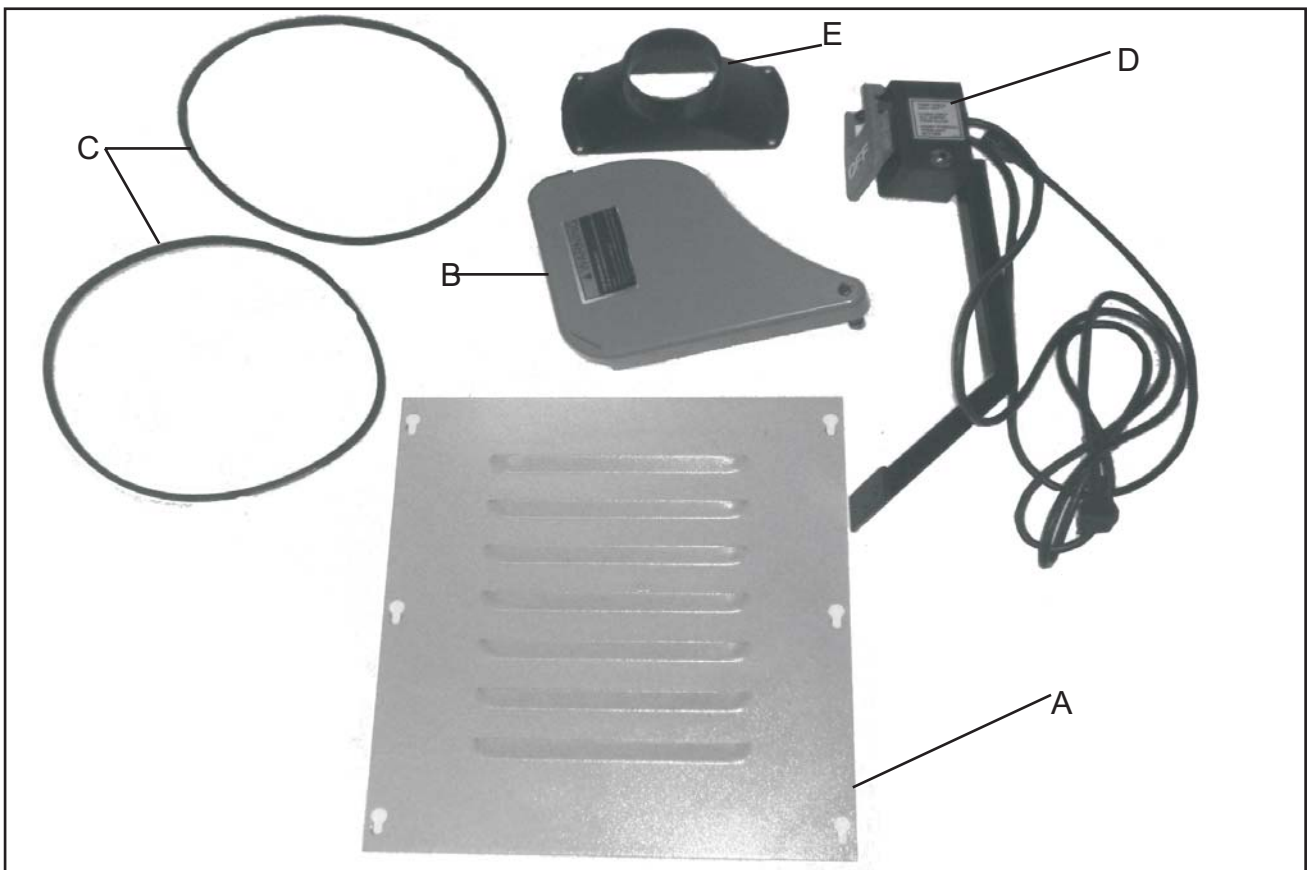

- A) Rear Panel
- B) Cutterhead Guard
- C) V-belts (2)

- D) Power Switch
- E) Dust Port

- F) Table Adjusting Handwheels (2)
- H) Handles (2)



- I) Joints Base



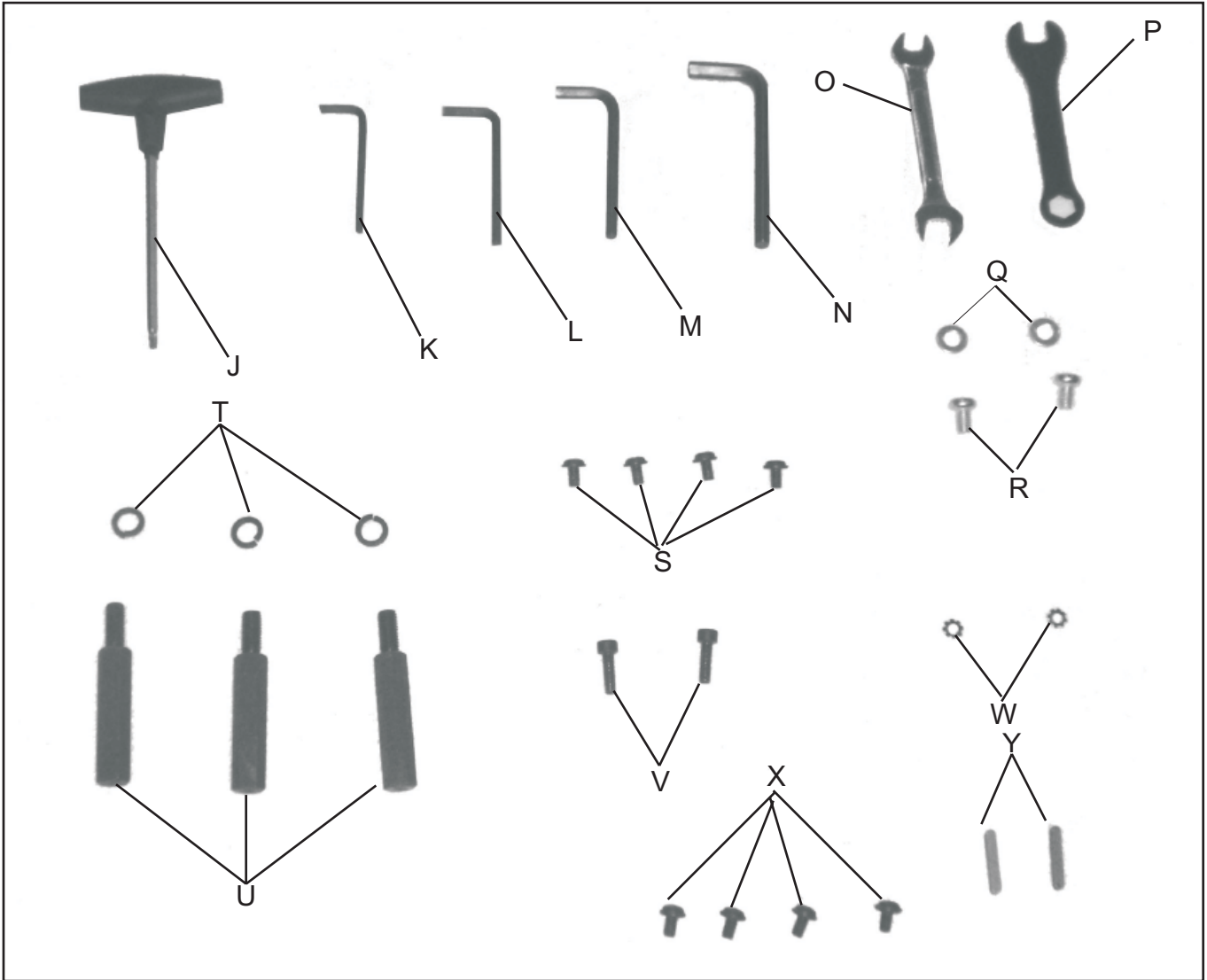

- J) T25 Star wrench
- K) 3mm Allen Wrench
- L) 4mm Allen Wrench
- M) 5mm Allen Wrench
- N) 8mm Allen Wrench
- O) 12x14mm Open End Wrench
- P) 13mm Open End Wrench
- Q) M8 Flat Washer (2)
- R) 5/16 Pan Head Screw (2)
- S) M6X8 Pan Head Screw (4)
- T) M10 Lock Washer (3)
- U) 3/8-16 Stud (3)
- V) M6X15 Soc Cap Screw (2)
- W) M6 Ex-toothed Washer (2)
- X) M6X10 Pan Head Flange Screw (4)
- Y) Key 5X5X22 (2)

ASSEMBLY

ASSEMBLING MOBILE BASE WHEELS

1. Turn the Base (A) upside down and mount the 2 non-swiveling wheels (B) to the base using one M8 x 50mm Hex head screw and one M8 flat washer for each wheel. **SEE FIG 1.**

Fig.1



2. Attach the leveling feet(C) to the base by screwing the threaded portion of the foot into the threaded holes in the base.
3. Attach the swiveling foot pedal (D) to the base using two M8 x 20mm Carriage bolts and two M8 hex nuts. **SEE FIG 2.**

Fig.2

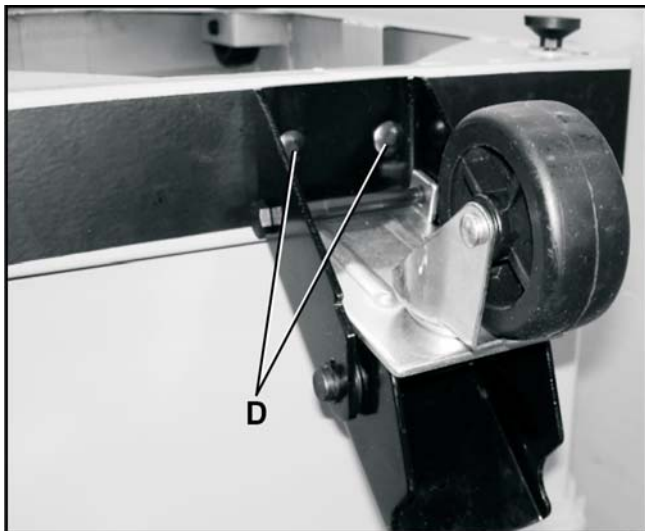

4. Turn the base back over so that the wheels are on the ground and adjust the leveling feet until the unit Does not rock or wobble.

MOUNTING JOINTER TO BASE

⚠ WARNING

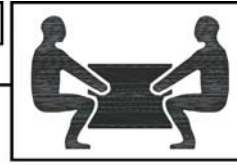

The Machine is heavy; two people are required to unpack and lift.

1. Be sure the pulley on the motor is in line with the cutout (A) in the top of the stand so the drive belt can pass through. **SEE FIG 3.**

Fig.3

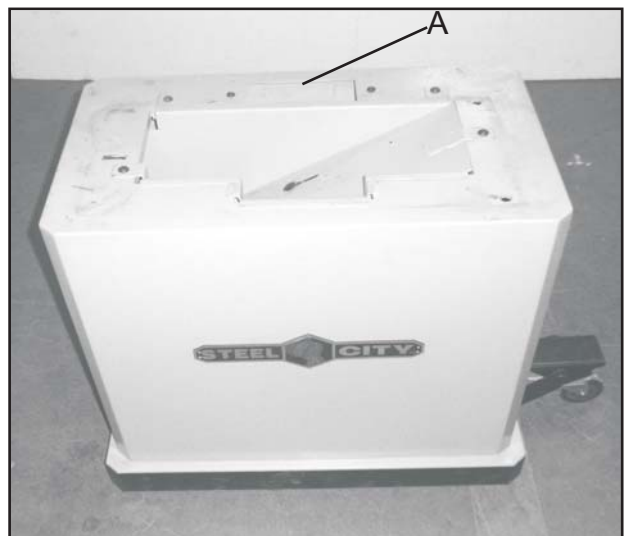

2. Using a helper, lift the jointer onto the stand. **SEE FIG.5**

Fig.5



- Align the 3 bolt holes located in the base of the jointer with the 3 holes in the stand.
- Use the special mounting studs and M10 lock washers, 2 of which are shown in FIG 6, to secure the jointer to the stand. Tighten securely. **SEE FIG 6.**

Fig.6

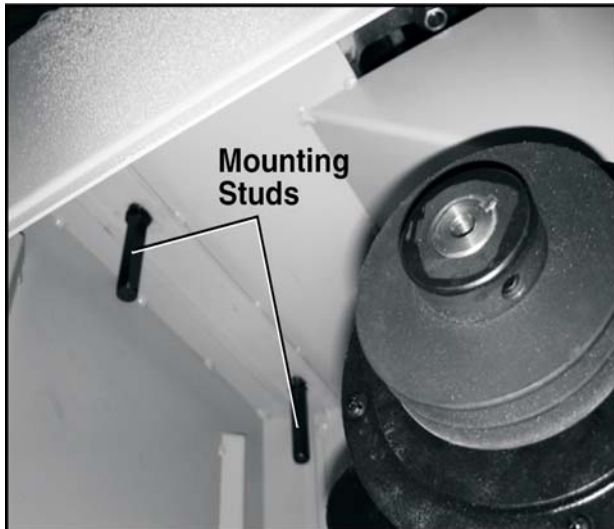

NOTE: The third mounting stud is accessible by reaching up through the hole in the top of the dust chute.

ASSEMBLING BELT AND ALIGNING PULLEYS

- Remove the cutterhead pulley guard (A) by loosening the screw (B) **SEE FIG 7.**

Fig.7

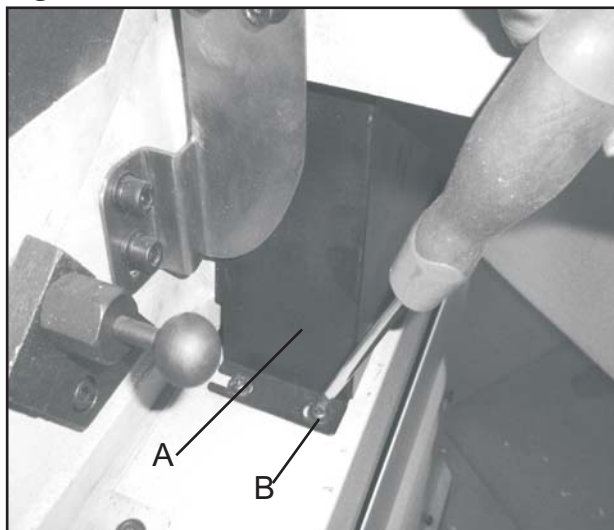

- Place the V-belts onto the cutterhead pulley(C) **SEE FIG 8.**
- Loosen the motor mounting bolts and raise the motor up until the belt fits around the motor pulley (D).

Fig.8

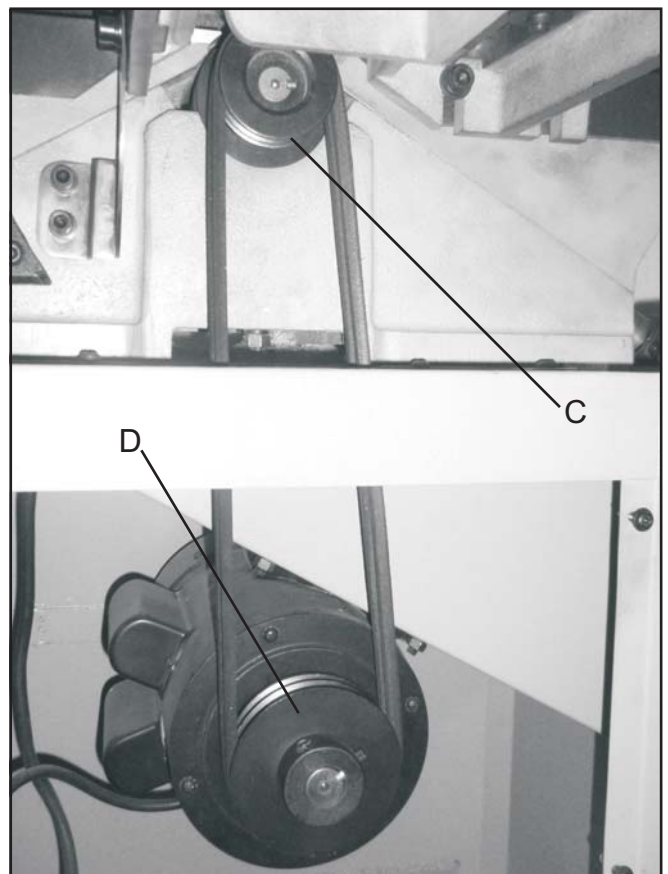

- Using a straight edge, check that both pulleys are aligned in the same plane. If the pulleys are not inline, reposition the motor until the pulleys are aligned.
- Tighten the motor mounting bolts. Check the alignment of the pulleys once more to assure nothing has moved.

NOTICE: If alignment cannot be met by moving the motor in or out, loosen the motor pulley set screws and move pulley in or out on the shaft until proper alignment is achieved.

▲ WARNING

The outside edge of the pulley must never be extended past the end of the motor shaft in any circumstance.

ADJUSTING BELT TENSION

- Correct belt tension is obtained when there is approximately 1" deflection at the center span of the belt using light finger pressure.
- If an adjustment is required, the motor can be raised or lowered to obtain the correct belt tension.
- Tighten motor mounting hardware after tension is applied, making sure alignment of the pulleys is not disturbed.
- Replace the cutterhead pulley guard.

ASSEMBLING FENCE CARRIAGE ASSEMBLY

The fence carriage assembly is already installed on the jointer at the factory. You only need to take a few steps for the fence to be fully operational.

▲ WARNING

MAKE CERTAIN THAT THE MACHINE IS DISCONNECTED FROM THE POWER SOURCE.

1. Insert the fence knob (A) through the hole, only this time make sure that the handle shaft goes through the top of the fence assembly. **SEE FIG 9.**

Fig.9

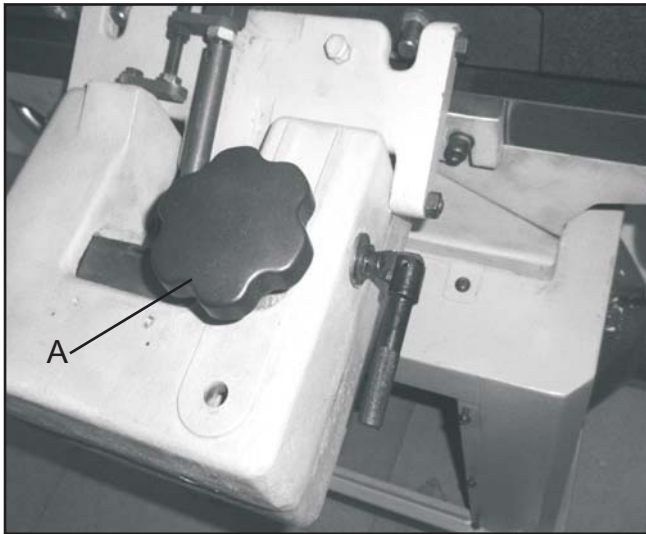

2. Fasten the special nut, to the bottom of the fence locking handle shaft. Make certain that the two prongs on the special nut face upwards and fit into the groove (C) on the bottom of the fence assembly. **SEE FIG 10.**

Fig.10



ASSEMBLING CUTTERHEAD GUARD

▲ WARNING

MAKE CERTAIN THAT THE MACHINE IS DISCONNECTED FROM THE POWER SOURCE.

▲ CAUTION

The cutterhead guard has a tension return spring. The tension on this spring is set at the factory. When the guard is installed properly it should return to the fence automatically after the workpiece has passed over the cutterhead. Be sure the guard is functioning properly before using the jointer.

1. Move the fence all the way to the rear of the table exposing the cutterhead.
2. Rotate the cutterhead by hand, using the belt, until there are no blades exposed. If this is not possible, place a thin piece of cardboard over the cutterhead. This is done to avoid exposure of hand to sharp Blade.

▲ CAUTION

Care must be taken when your hands are near the knives as the cutting edges are very sharp.

3. Locate the mounting hole(A) on the right hand side of the rabbetting ledge. Check to make sure that the locking set screw(B) is not protruding into the mounting hole at this time. **SEE FIG 11.**

Fig.11

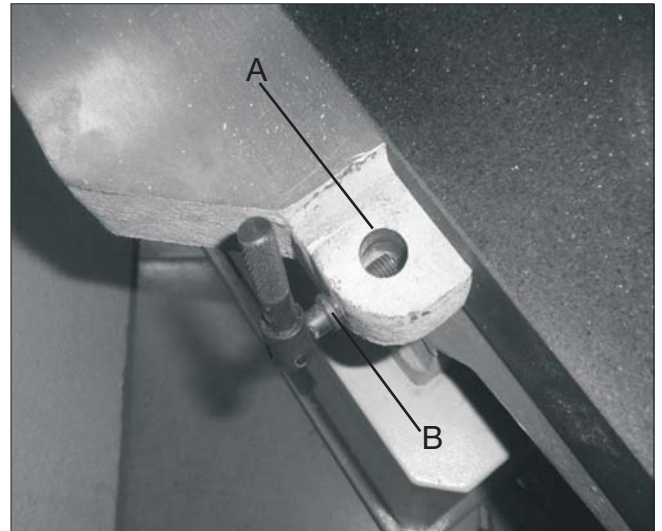

4. Place the guard above the table positioned over the cutterhead with curved edge against fence and drop the shaft in the hole. The pin (C) should be below the surface of the infeed table and pressed up against the side of the jointer. **SEE FIG 12.**

Fig.12

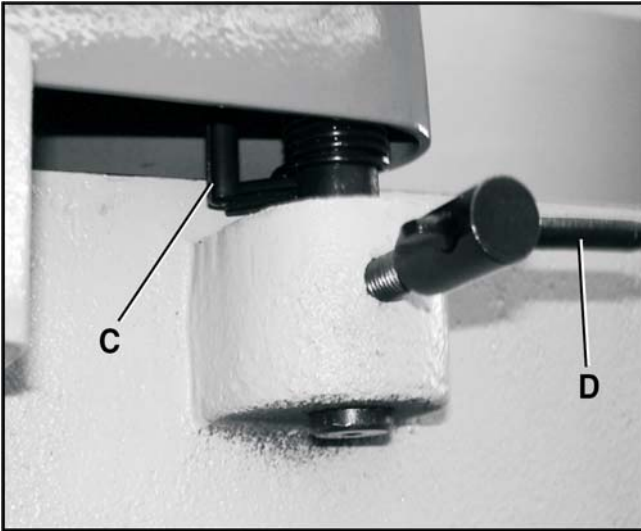

5. Tighten the set screw using the handle (D).
6. Check guard clearance to be sure it is not dragging over table surface or cutterhead. If the guard is too low, loosen the set screw and raise the guard slightly. Test the guard and be sure it springs back to the fence when pulled out. Test with the fence in its furthest position from the guard. Make it a habit to check this important safety feature every time before Using the jointer.

ASSEMBLING DUST PORT

1. The jointer stand has a built in dust chute. If this machine is to be hooked up to a dust collection system, the supplied dust port can be fastened to the jointer stand using four M6x8mm pan head screws and four flat washers. **SEE FIG 13.**

Fig.13



2. A standard dust collection hose can now be attached to this port.

NOTE: DO NOT ATTACH THE DUST PORT IF YOU DO NOT PLAN TO CONNECT THE JOINTER TO ADUST COLLECTION SYSTEM.

ATTACHING SWITCH

1. Locate the 2 threaded holes on the back side of the infeed table.
2. Line up the two holes on the switch bracket (A) with the two threaded holes in the jointer. **SEE FIG 14.**

Fig.14

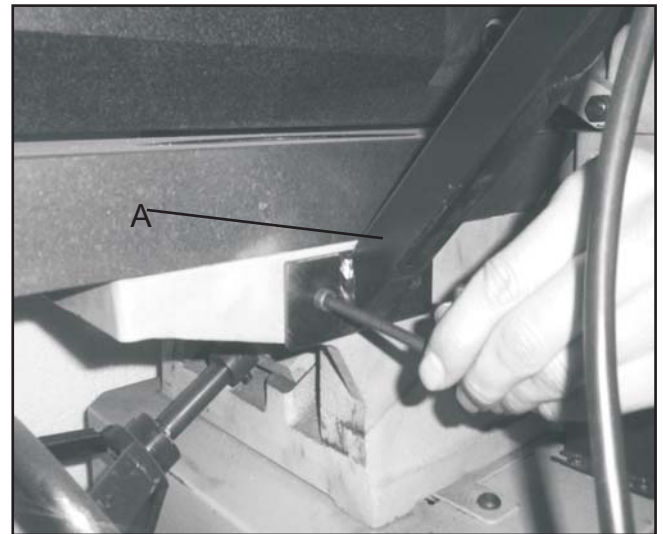

3. Fasten using two M6x15mm hex soc head cap screws and two lock washers. Tighten securely.
4. Insert the power prong (B) of switch power cord into The prong (C) of motor power cord . **SEE FIG 15.**

Fig.15

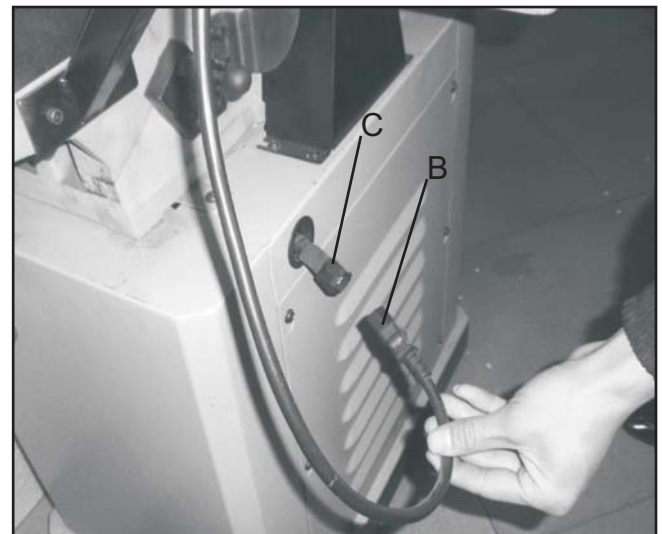

HANDWHEEL ASSEMBLY

The purpose of the handwheels is to raise and lower the outfeed and infeed tables. The procedure for installation is the same for both the infeed and outfeed sides of the jointer. To install:

1. The key (A) pan head screw (B) and flat washer (C) should already be attached to the shaft.
SEE FIG. 16.

Fig.16

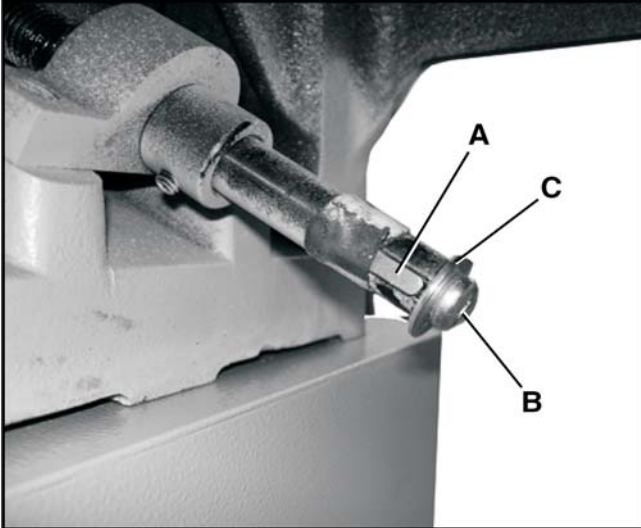

2. Remove the pan head screw and flat washer. Remove the tape from the key.
3. Insert the handwheel onto the shaft making sure that the notch in the handwheel lines up with the key on the shaft.
4. Fasten the handwheel to the shaft using pan head screw and flat washer removed in step 2.
5. Thread the handle (D) into the threaded hole (E) in the handwheel. **SEE FIG 17.**

Fig.17

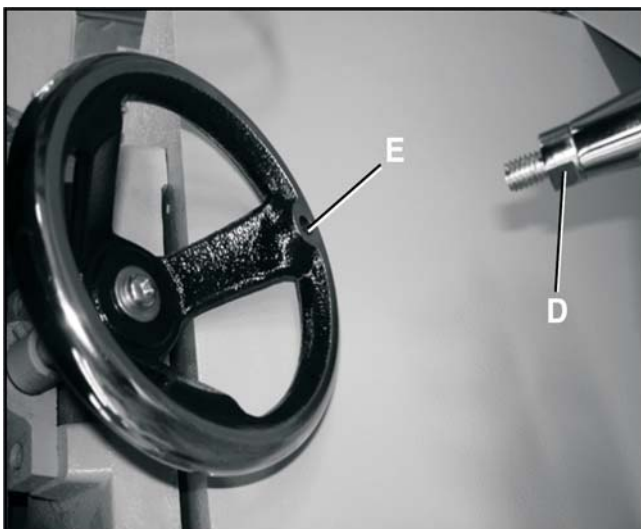

REAR ACCESS PANEL

The access panel needs to be installed on the rear of the jointer base. To install

1. Place the bottom edge of the access panel (A) on the lower edge of the jointer base. **SEE FIG 18.**
2. Lift up the access panel and fasten shut using six M6X12mm pan head screws (B).

Fig.18

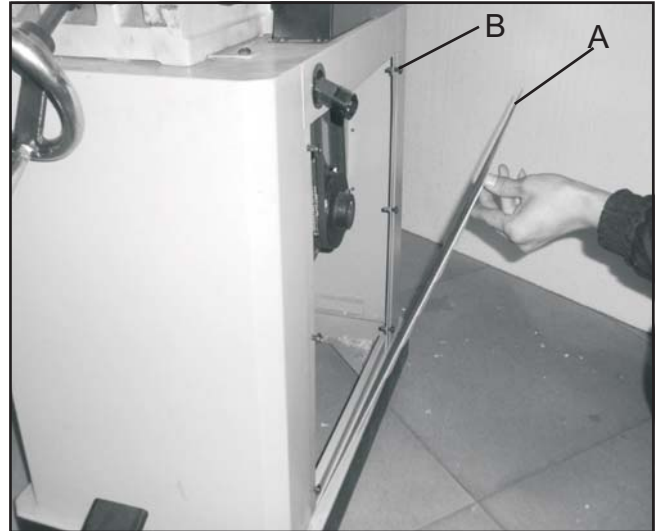

ADJUSTMENTS

INFEED TABLE ADJUSTMENTS

To raise or lower the infeed table, loosen infeed table lock handle (B) and turn the table raising and lowering handwheel (A) until the table is at the desired position and tighten infeed table lock handle. SEE FIG. 19.

Fig.19

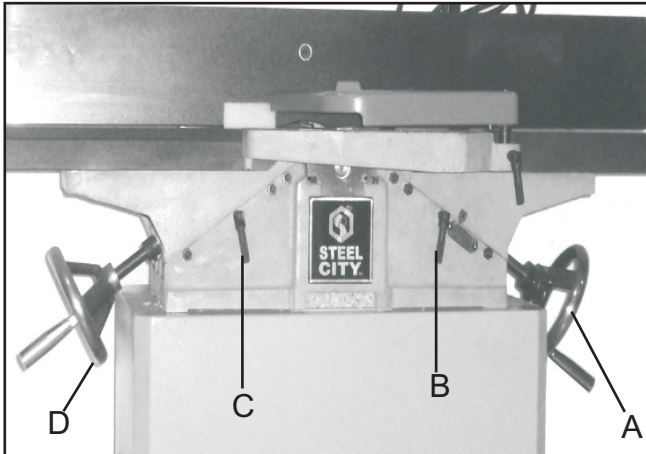

INFEED POSITIVE STOP

There is a safety feature that will not allow the infeed table to drop below a 1/8-in depth of cut. This stop (A) is located on the rear of the jointer. Once the jointer hits a depth of 1/8", the spring loaded knob snaps into a hole in the infeed table. To make the infeed table go lower than this, you will have to pull out on the knob as you lower the table. SEE FIG 19.

Fig.20

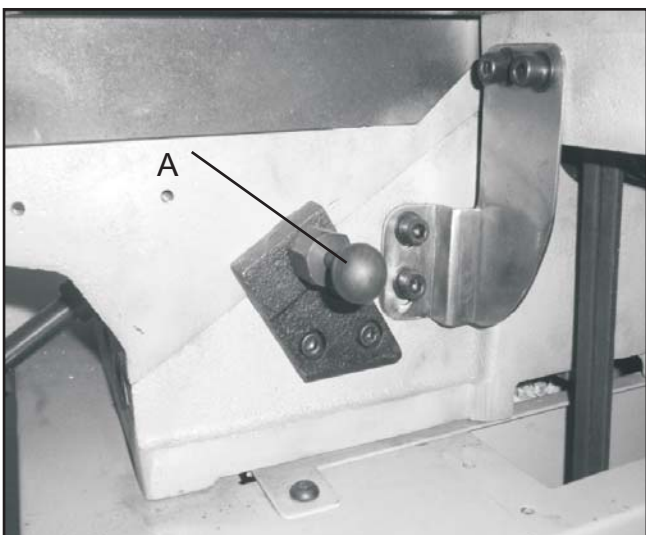

OUTFEED TABLE ADJUSTMENTS

⚠ WARNING

DISCONNECT MACHINE FROM POWER SOURCE.

The outfeed table must be exactly level with the knives when the knives are at their highest point of revolution. To move the outfeed table, loosen outfeed table lock handle (C) and turn the table raising and lowering handwheel (D) until the table is level with the knives. When the outfeed table is exactly level with the knives at their highest point of revolution, tighten outfeed table lock handle. SEE FIG. 19.

STRAIGHT KNIFE ADJUSTMENTS

⚠ CAUTION

Care must be taken when handling the knives as the cutting edges are very sharp. The quick change knives on your jointer are double sided and are mounted on special pins. These pins automatically set the knife at its proper height, eliminating the need for a knife gauge. While the knives on your jointer come preinstalled at the factory, the following pro-cedures detail how to remove and install a set of knives.

1. Start in the center of the knife gib and remove the M6x16 mm allen head screw (A). SEE FIG 21.

Fig.21



2. Alternate sides as you loosen the remaining screws along the length of the gib
3. Remove the black knife gib. The knife below can now be lifted off of the (2) locating pins.
4. Flip the knife over if necessary to expose new edge And mount the knife back on the (2) locating pins.

5. Place the black knife gib over the knife with the angled side up and the angle in the same direction as the knife edge.
6. Line the outside edges of the knife up with each Other.
7. Replace the (5) 4 MM Allen head screws and tighten from the center out alternating sides as you go.
MAKE CERTAIN THAT THE ALLEN HEAD SCREWS ARE TIGHTENED ALL THE WAY INTO THE CUTTERHEAD.
8. Repeat this procedure for all three knives.

HELICAL CUTTERHEAD ROTATING / CHANGING CARBIDE CUTTERS

The 8" cutterhead is equipped with 16 indexable carbide cutters; Each cutter can be rotated to reveal any one of its four cutting edges. Therefore, if one cutting edge becomes dull or damaged, simply rotate it 90 to reveal a fresh cutting edge (**Figure 22**).

In addition , each cutter has a reference dot on one corner. As the cutter is rotated , the reference dot location can be used as an indicator of which edges are used and which are new. When the reference dot revolves back around to its starting position, the cutter should be replaced.

Fig. 22

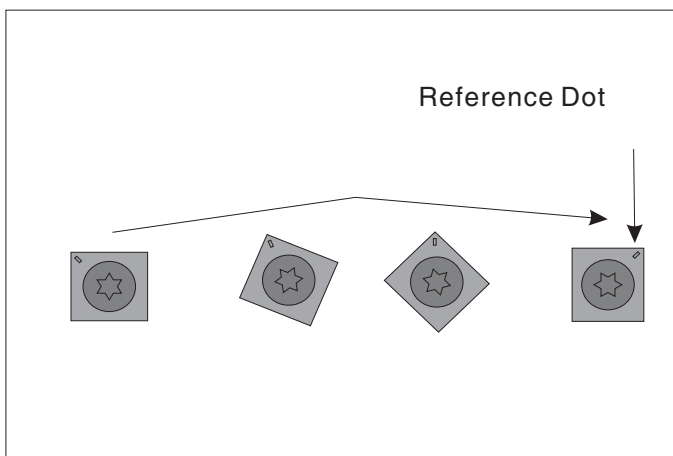

TO ROTATE OR CHANGE A CARBIDE CUTTER:

1. DISCONNECT THE PLANER FROM THE POWER SOURCE!
2. Remove any sawdust from the head of the carbide cutter Torx screw.
3. Remove the Torx screw and carbide cutter.
4. Clean all dust and dirt off the cutter and the cutterhead pocket from which the cutter was removed, and replace the cutter so a fresh, sharp edge is facing outward.

Note: Proper cleaning is critical to achieving a smooth finish. Dirt or dust trapped between the cutter and cutterhead will slightly raise the cutter, and make a

noticeable marks on your work-pieces the next time you plane.

5. Lubricate the Torx screw threads with a light machine oil, wipe the excess oil off the threads, and torque the Torx screw to 48-50 inch/ pounds.

ADJUSTING FENCE POSITIVE STOPS

The fence on your jointer is equipped with positive stops at the most used fence positions of 90 degrees and 45 degrees in and out. To check and adjust the positive stops, proceed as follows:

⚠ WARNING

MAKE CERTAIN THAT THE MACHINE IS DISCONNECTED FROM THE POWER SOURCE.

1. Position the fence at 90 degrees to the table by loosening the bevel lock handle(A) and moving the fence until 90 degree stop screw (B) hits the stop(C).
SEE FIG 23.

Fig.23

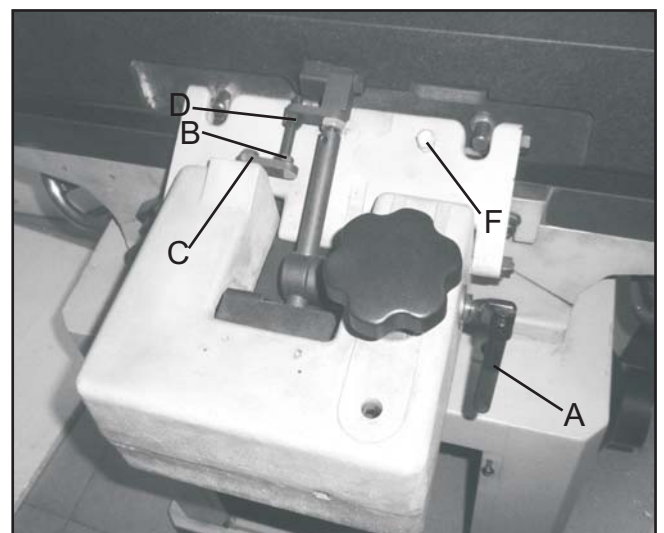

2. Using a square, check to see if the fence is at 90 degrees to the table.
3. If the fence is not at 90 degrees, loosen nut (D) and adjust the stop screw (B) until the fence is at 90 degrees to the table. Retighten nut (D).

Fig.24

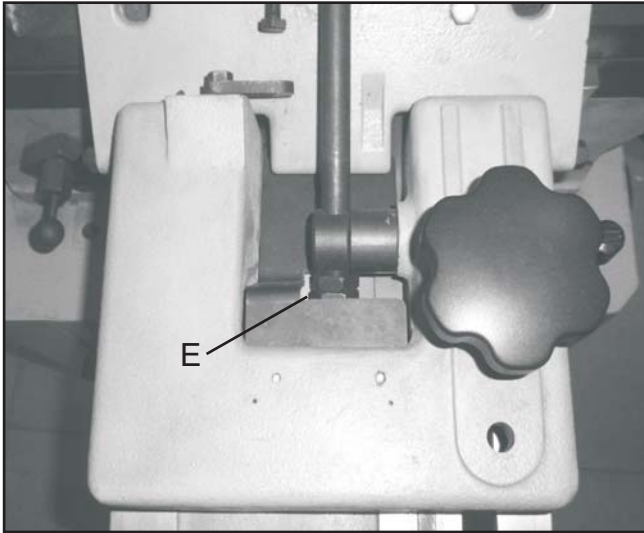

4. Tilt the fence inward until it hits the 45 degree in stop nut (E). **SEE FIG. 24.**
5. Using a combination square, check to see if the fence is indeed tilted in at 45 degrees. **SEE FIG 25.**

Fig.25



6. If an adjustment is necessary, tighten or loosen the stop nut (E) until the fence is at 45 degrees.
7. Tilt the fence outward to 45 degrees. To do this you will have to flip the 90 degree stop (C) out of the way so that it faces towards the infeed table. **SEE FIG 23**
8. Using a combination square, check to see if the fence is tilted at 45 degrees. **SEE FIG 26.**

Fig.26



9. If an adjustment is necessary, loosen or tighten stop screw (F) until the fence is at 45 degrees. **SEE FIG 23.**

OPERATIONS

According to many OSHA, ANSI, STATE, and LOCAL CODES, it is the Employers Responsibility to:

- **PERMIT ONLY** trained and authorized employees to operate equipment.
- **INSPECT AND MAINTAIN** guards, safety devices and start/stop controls.
- **INSTRUCT, TRAIN and SUPERVISE** the safe method of work.

⚠ WARNING

Serious personal injury may occur if normal safety precautions are overlooked or ignored. Accidents are frequently caused by lack of familiarity or failure to pay attention. Obtain advice from supervisor, instructor, or another qualified individual who is familiar with the machine and its operations.

Every work area is different. Always consider safety first, as it applies to your work area. Use any machine with respect and caution. Failure to do so could result in serious personal injury and damage to the machine.

STOP using the machine, if at any time you experience difficulties in performing any operation. Contact your supervisor, instructor or machine service center immediately.

START/STOPSWITCH

The START/STOP switch assembly is located above the infeed table. To turn the jointer "ON", push the green start button (A). To turn the jointer "OFF", push the red stop paddle (B). **SEE FIG. 27.**

Fig.27

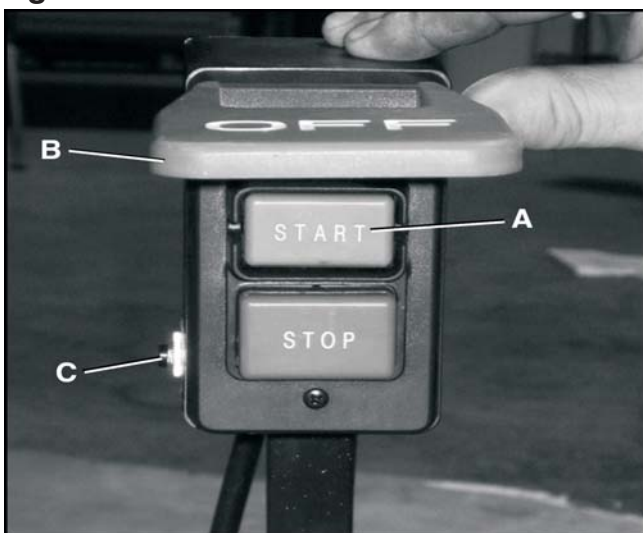

⚠ WARNING

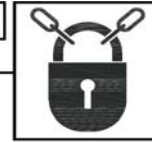

CHILDPROOF THE WORKSHOP AREA by removing switch keys, unplugging tools from the electrical receptacles, and using padlocks.

MOTOR OVERLOAD PROTECTION

Your Jointer is supplied with an automatic thermal overload on the motor. If the motor shuts off or fails to start due to an overload condition, turn the Jointer "OFF," let the motor cool for three to five minutes, The motor can then be turned on again in the usual manner.

PLACEMENT OF HANDS DURING FEEDING

At the start of the cut, the left hand holds the work firmly against the infeed table and fence, while the right hand pushes the work toward the knives. After the cut is underway, the new surface rests firmly on the outfeed table. The left hand should then be moved to the work on the outfeed table, at the same time maintaining flat contact with the fence. The right hand presses the work forward, and before the right hand reaches the cutterhead, it should be moved to the work on the outfeed table.

⚠ WARNING

NEVER PASS HANDS DIRECTLY OVER THE CUTTERHEAD.

DIRECTION OF GRAIN

Avoid feeding work into the jointer against the grain. The result will be chipped and splintered edges. Feed with the grain to obtain a smooth surface.

FENCE OPERATION

The fence can be moved across the table by loosening the fence knob (A) and push or pull the fence. **SEE FIG 28.**

Fig.28

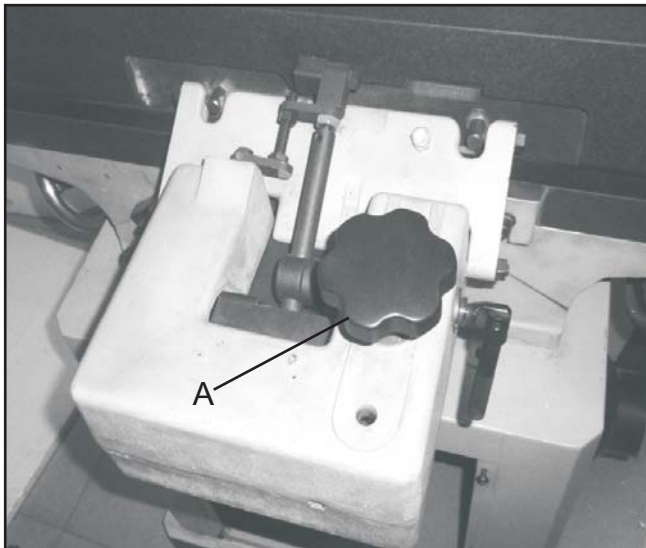

JOINTING AN EDGE

This is the most common operation for the jointer. These cuts are made to square an edge of a work-piece. Set the guide fence square with the table. Depth of cut should be the minimum required to obtain a straight edge. Hold the best face of the piece firmly against the fence throughout the feed as shown in Fig. 29. **SEE FIG. 29.**

Fig.29



CAUTION

MAXIMUM DEPTH OF CUT SHOULD NOT BE MORE THAN 1/8" IN ONE PASS.

CAUTION

DO NOT PERFORM JOINTING OPERATIONS ON MATERIAL SHORTER THAN 10 INCHES, NARROWER THAN 3/4 INCH, OR LESS THAN 1/2 INCH THICK.

SURFACING

Surfacing is similar to the edge jointing operation except for the position of the workpiece. For surfacing, the major flat surface of the workpiece is placed on the infeed table of the jointer with the narrow edge of the workpiece against the fence, as shown in Fig. 30. The workpiece is moved from the infeed table, across the cutterhead to the outfeed table, establishing a flat surface on the workpiece. **SEE FIG. 30.**

Fig.30



WARNING

ALWAYS USE PUSH BLOCKS WHEN PERFORMING SURFACING OPERATIONS AND NEVER PASS YOUR HANDS DIRECTLY OVER THE CUTTERHEAD.

CAUTION

MAXIMUM DEPTH OF CUT SHOULD NOT BE MORE THAN 1/8" IN ONE PASS.

BEVELING

To cut a bevel, lock the fence at the required angle and run the work across the knives while keeping the work firmly against the fence and tables. Several passes may be necessary to arrive at the desired result. When the angle is small, there is little difference whether the fence is tilted in or out. However, at greater angles approaching 45 degrees, it is increasingly difficult to hold the work properly when the fence is tilted out. The advantage of the double-tilting fence is appreciated under such conditions. When tilted in, the fence forms a V-shape with the tables, and the work is easily pressed into the pocket while passing it across the knives. If the bevel is laid out on the piece in such direction that this involves cutting against the grain, it will be better to tilt the fence out.

TAPER CUTS

One of the most useful jointer operations is cutting an edge to a taper. This method can be used on a wide variety of work. Tapered legs of furniture are a common example. Instead of laying the piece on the infeed table, lower the forward end of the work onto the outfeed table. Do this very carefully, as the piece will span the knives, and they will take a "bite" from the work with a tendency to kick back unless the piece is firmly held. Now push the work forward as in ordinary jointing. The effect is to surface off all the stock in front of the knives, to increasing depth, leaving a tapered surface. The ridge left by the knives when starting the taper may be removed by taking a very light cut according to the regular method for jointing, with the infeed table raised to its usual position. Practice is required in this operation, and the beginner is advised to make trial cuts on waste material. Taper cuts over part of the length and a number of other special operations can easily be done by the experienced craftsman.

SURFACING WARPED PIECES

If the wood to be surfaced is dished or warped, take light cuts until the surface is flat. Avoid forcing such material down against the table; excessive pressure will spring it while passing the knives, and it will spring back and remain curved after the cut is completed.

CUTTING A RABBET

When making a rabbet cut, the cutterhead guard must be removed.

CAUTION

AFTER THE RABBET CUT IS COMPLETED, BE CERTAIN GUARD IS REPLACED.

1. Adjust the fence so that the distance between the end of the knives and the fence is equal to the width of the rabbet.
2. Lower the infeed table an amount equal to the depth of the rabbet. If the rabbet is quite deep, it may be necessary to cut it in two or more passes. In that event, the table is lowered an amount equal to about half the depth of the rabbet for the first pass, then lowered again to proper depth to complete the cut.

MAINTENANCE

- **DO NOT** begin cleaning up until you have read and understand all of the clean up instructions.
- **DO NOT USE FLAMMABLE MATERIALS TO CLEAN JOINTER.**

CLEANING

⚠ WARNING

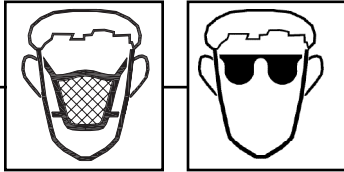

With the machine unplugged, blow off motor with low pressure air to remove dust or dirt. Air pressure above 50 P.S.I. should not be used as high-pressure air may damage insulation. The operator should always wear a respirator and eye protection when using compressed air.

Do not allow chips and dust to accumulate under jointer. Keep area clean and in safe order.

⚠ WARNING

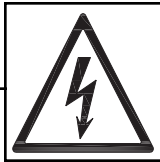

Turn the power switch "OFF" and unplug the power cord from its power source prior to any maintenance.

LUBRICATION

The jointer has sealed lubricated bearings in the motor housing that do not require any additional lubrication from the operator.

⚠ WARNING

Repairs to the jointer should be performed by trained personnel only. Contact your nearest Steel City Dealer for authorized service. Unauthorized repairs or replacement with non-factory parts could cause serious injury to the operator and damage to the jointer.

SHARPENING KNIVES

The knives on your jointer are a special quick-set type and can not be sharpened. The knives, however, are double sided, so when one edge of the knives goes dull, you can simply flip the blade around and use the other edge of the knife. Once both sides have been used, the knives **MUST** be replaced. Replacement knives are available through your Steel City distributor. The following procedure details how to either flip over an existing set of knives or how to install a new set of knives.

Fig. 33

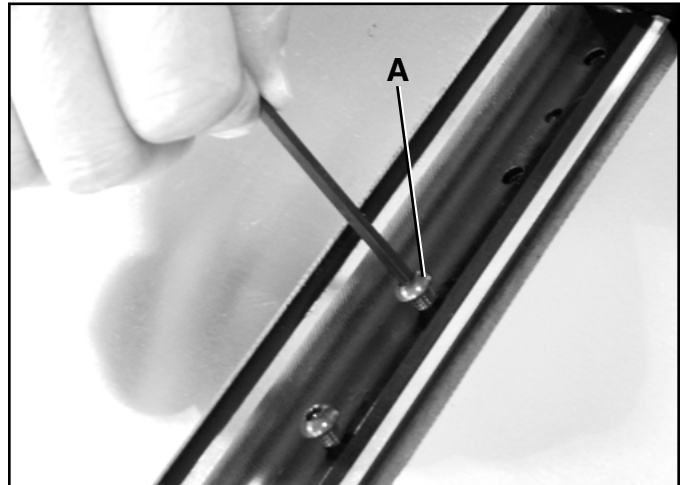

1. Start in the center of the knife gib and remove the 4 mm allen head screw (A). **SEE FIG. 33.**
2. Alternate sides as you loosen the remaining screws along the length of the gib
3. Remove the black knife gib. The knife below can now be lifted off of the (2) locating pins.
4. Flip the knife over if necessary to expose new edge and mount the knife back on the (2) locating pins.
5. Place the black knife gib over the knife with the angled side up and the angle in the same direction as the knife edge.
6. Line the outside edges of the knife up with each other.
7. Replace the (5) 4 MM Allen head screws and tighten from the center out alternating sides as you go. **MAKE CERTAIN THAT THE ALLEN HEAD SCREWS ARE TIGHTENED ALL THE WAY INTO THE CUTTERHEAD.**
8. Repeat this procedure for all three knives.

TROUBLESHOOTING GUIDE

Motor and Machine Operation

PROBLEM	LIKELY CAUSE(S)	SOLUTION
Motor will not start.	<ol style="list-style-type: none"> 1. Low voltage. 2. Open circuit in motor or loose connections. 	<ol style="list-style-type: none"> 1. Check power line for proper voltage. 2. Inspect all lead connections on motor for loose or open connections. Refer to Fig. 16, page 22 for proper connection procedure.
Fuses or circuit breakers blow.	<ol style="list-style-type: none"> 1. Short circuit in line cord or plug. 	<ol style="list-style-type: none"> 1. Repair or replace cord or plug for damaged insulation and shorted wires
Motor fails to develop full power (output of motor decreases rapidly with decrease in voltage at motor terminals).	<ol style="list-style-type: none"> 1. Power supply circuit overloaded with lights, appliances, and other motors. 2. Undersized wires or circuits too long. 	<ol style="list-style-type: none"> 1. Reduce load on circuit. 2. Increase wire sizes or reduce length of the circuit.
Motor overheats.	<ol style="list-style-type: none"> 1. Motor overloaded during operation. 2. Air circulation through the motor restricted. 	<ol style="list-style-type: none"> 1. Reduce load on motor; take lighter cuts. 2. Clean out motor to provide normal air circulation.
Motor stalls or shuts off during a cut.	<ol style="list-style-type: none"> 1. Motor overloaded during operation. 2. Short circuit in motor or loose connections. 3. Circuit breaker tripped. 	<ol style="list-style-type: none"> 1. Reduce load on motor; take lighter cuts. 2. Repair or replace connections on motor for loose or shorted terminals or worn insulation. 3. Install correct circuit breaker; reduce number of machines running on that circuit (circuit overload).
Blade slows when cutting or makes a squealing noise, especially on start-up.	<ol style="list-style-type: none"> 1. V-belt loose. 2. V-belt worn out. 	<ol style="list-style-type: none"> 1. Tighten V-belt. 2. Replace V-belt.
Loud, repetitious noise coming from machine.	<ol style="list-style-type: none"> 1. Pulley setscrews or keys are missing or loose. 2. Motor fan is hitting the cover. 3. V-belts are damaged. 	<ol style="list-style-type: none"> 1. Inspect keys and setscrews. Replace or tighten if necessary. 2. Adjust fan cover mounting position, tighten fan, or shim fan cover. 3. Replace V-belts.
Vibration when running or cutting.	<ol style="list-style-type: none"> 1. Loose or damaged knife. 2. Damaged V-belt. 3. Worn cutterhead bearings. 	<ol style="list-style-type: none"> 1. Tighten or replace knife. 2. Replace. 3. Check/replace cutterhead bearings.

Table

PROBLEM	LIKELY CAUSE(S)	SOLUTION
Tables are hard to adjust.	<ol style="list-style-type: none"> 1. Table lock is engaged or partially engaged. 	<ol style="list-style-type: none"> 1. Completely loosen the table lock.

Cutting

PROBLEM	LIKELY CAUSE(S)	SOLUTION
Excessive snipe (gouge in the end of the board that is uneven with the rest of the cut).	<ol style="list-style-type: none"> 1. Outfeed table is set too low. 2. Operator pushing down on end of workpiece. 	<ol style="list-style-type: none"> 1. Align outfeed table with cutterhead knife at top dead center. 2. Reduce/eliminate downward pressure on that end of workpiece.
Workpiece stops at the beginning of the cut.	<ol style="list-style-type: none"> 1. Outfeed table is set too high. 	<ol style="list-style-type: none"> 1. Align outfeed table with cutterhead knife at top dead center.
Chipping.	<ol style="list-style-type: none"> 1. Knots or conflicting grain direction in wood. 2. Nicked or chipped blades. 3. Feeding workpiece too fast. 4. Taking too deep of a cut. 	<ol style="list-style-type: none"> 1. Inspect workpiece for knots and grain; only use clean stock. 2. Adjust one of the nicked knives sideways; replace knives. 3. Slow down the feed rate. 4. Take a smaller depth of cut. (Always reduce cutting depth when surface planing or working with hard woods.)
Fuzzy grain.	<ol style="list-style-type: none"> 1. Wood may have high moisture content. 2. Dull knives. 	<ol style="list-style-type: none"> 1. Check moisture content and allow to dry if moisture is too high. 2. Replace knives.
Long lines or ridges that run along the length of the board.	<ol style="list-style-type: none"> 1. Nicked or chipped knives. 	<ol style="list-style-type: none"> 1. Adjust one of the nicked knives sideways; replace knives.
Uneven cutter marks, wavy surface, or chatter marks across the face of the board.	<ol style="list-style-type: none"> 1. Feeding workpiece too fast. 2. Knives not adjusted at even heights in the cutterhead. 	<ol style="list-style-type: none"> 1. Slow down the feed rate. 2. Adjust the knives so they are set up evenly in the cutterhead.
Board edge is concave or convex after jointing.	<ol style="list-style-type: none"> 1. Board not held with even pressure on infeed and outfeed table during cut. 2. Board started too uneven. 3. Board has excessive bow or twist along its length. 4. Insufficient number of passes. 	<ol style="list-style-type: none"> 1. Hold board with even pressure as it moves over the cutterhead. 2. Take partial cuts to remove the extreme high spots before doing a full pass. 3. Surface plane one face so there is a good surface to position against the fence. 4. It may take 3 to 5 passes to achieve a perfect edge, depending on the starting condition of the board and the depth of cut.
Uneven cut or breakout when rabbeting.	<ol style="list-style-type: none"> 1. Uneven feed rate. 2. Depth of cut too deep. 3. Knives not adjusted evenly with each other in the cutterhead. 4. Nicked or chipped knives. 	<ol style="list-style-type: none"> 1. Feed the board evenly and smoothly during the cut. 2. Raise the infeed table to take a smaller depth of cut. Never exceed 1/16" per pass when rabbeting. 3. Adjust the knives so they are set up evenly in the cutterhead. 4. Adjust one of the nicked knives sideways; replace knives.

◆ NOTES ◆

PARTS

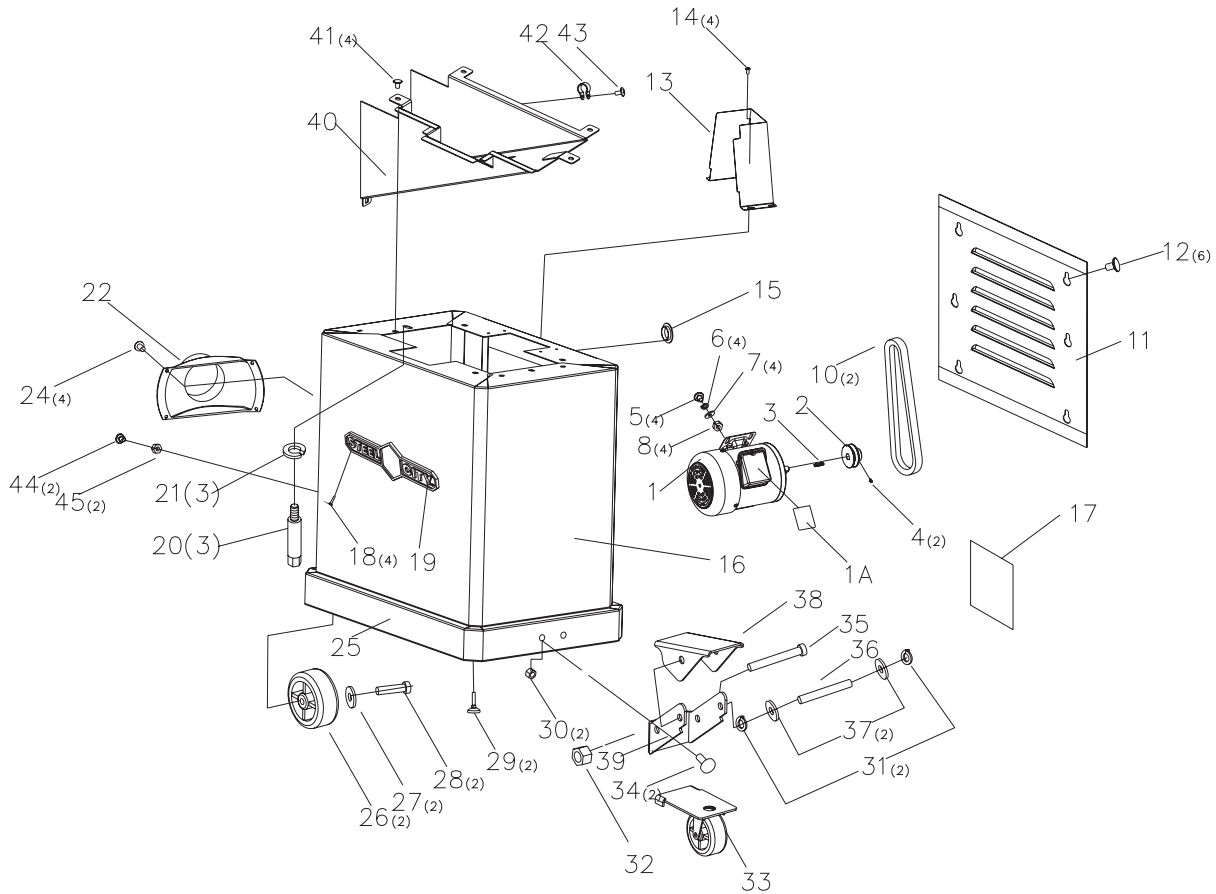

KEY NO.	PART NO.	DESCRIPTION	QTY.	KEY NO.	PART NO.	DESCRIPTION	QTY.
1	OR74543	MOTOR(2HP 120V/240V 1HP)	1	24	OR94777	M6x8 PAN HD SCR	4
1A	OR74544	MOTOR SPEC LABEL	1	25	OR72998	PASTER	2.1m
2	OR74545	MOTOR PULLEY	1	26	OR72924	CASTER WHEEL	2
3	OR90219	5x5x30mm KEY	1	27	OR90311	M8 FLAT WASHER	2
4	OR74546	3/8-16x1/4 SOC HEAD SCREW	2	28	OR91497	M8x50mm HEX HD BOLT	2
5	OR94775	M8x20mm CARRIAGE BOLT	4	29	OR91132	LEVER SCR	2
6	OR90311	M8 FLAT WASHER	4	30	OR94771	M8 HEX FLANGE NUT	2
7	OR90248	M8 LOCK WASHER	4	31	OR91507	EXT. RET. RING 1/2"	2
8	OR90307	M8 HEX NUT	4	32	OR91503	5/16-18 LOCK NUT	1
10	OR74547	V-BELT(Z-990)	2	33	OR91056	CASTER ASSY	1
11	OR72918	JOINT PLATE	1	34	OR94775	M8x20mm CARRIAGE BOLT	2
12	OR94772	M6x20mm PAN HD SCR	6	35	OR91502	5/16-18x4" HEX HD SCR	1
13	OR72911	PULLEY GUARD	1	36	OR91508	PIN	1
14	OR94769	M6x10mm PAN HD SCR	4	37	OR91504	1/2" FLAT WASHER	2
15	OR72912	INSULATOR	1	38	OR91469	FOOT PEDAL	1
16	OR74548	FRAME	1	39	OR72922	REAR WHEEL BRACKET	1
17	OR74551	SPEC LABEL	1	40	OR74550	MOTOR BRACKET	1
18	OR93823	2x8 RIVET	4	41	OR93380	M8x15mm SCR	4
19	OR70484	NAME PLATE	1	42	OR91737	WIRE CODE	1
20	OR74549	MOUNTING STUD	3	43	OR90761	M5x10mm PAN HD SCR	1
21	OR90227	M10 LOCK WASHER	3	44	OR94771	M8 HEX FLANGE NUT	2
22	OR91128	DUST CHUT	1	45	OR94776	M8x16mm CARRIAGE BOLT	2

Straight Cutterhead Ass'y

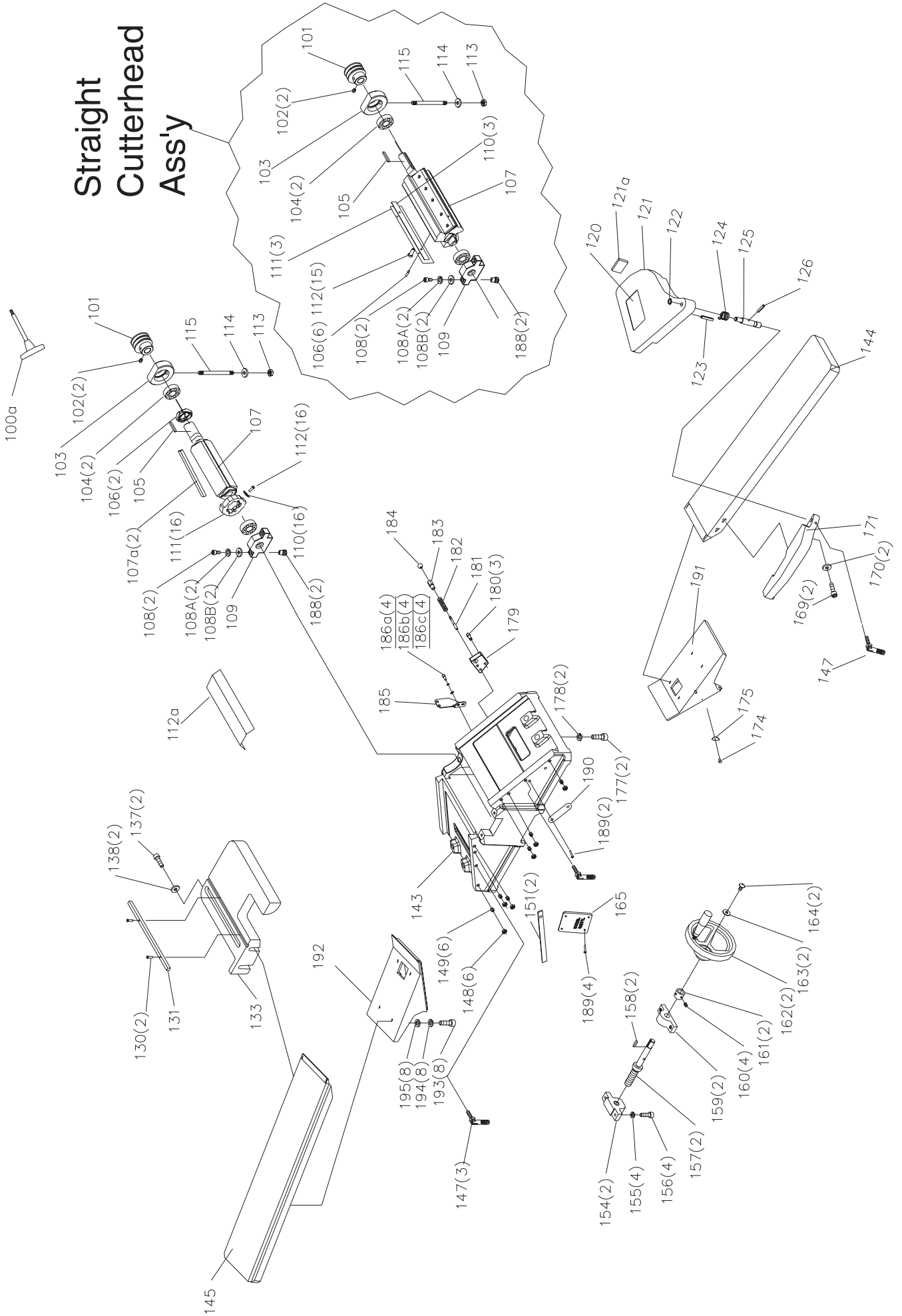

KEY NO.	PART NO.	DESCRIPTION	QTY.	KEY NO.	PART NO.	DESCRIPTION	QTY.
100	OR74552	CUTTER HEAD ASS'Y (REF NO.106、107 107a、100a、110、111、112)	107 1	145	OR74578	OUTER FEED TABLE	1
101	OR74553	CUTTER HEAD PULLEY	1	147	OR74579	LOCK KNOB	3
102	OR74554	5/16-18X3/8 SOC HEAD SCREW	2	148	OR74580	5/16-18 HEX NUT	6
103	OR74555	BEARING BRACKET	1	149	OR74581	SET SCREW	6
104	OR74556	BALL BEARING (6204-2Z)	2	151	OR74582	GIB PLATE	2
105	OR74557	5X5X22MM KEY	1	154	OR74583	BRACKET	2
106	OR74558	CUTTER NUT	2	155	OR90227	M10 LOCK WASHER	4
107	OR74559H	CUTTER HEAD	1	156	OR74584	3/8-16x1-1/4 SOC HEX HD SCR	4
107a	OR74560	5X5X198MM KEY	2	157	OR74585	WORM SHAFT	2
108	OR74561	1/4-20X1-1/2 SOC HEAD CAP SCREW	2	158	OR74557	5x5x22mm KEY	2
108A	OR90502	M6 LOCK WASHER	2	159	OR74586	BRACKET	2
108B	OR72319	SPECIAL FLAT WASHER	2	160	OR74587	1/4-20x3/8 SOC HEX HD SET SCR	4
109	OR74562	BEARING BRACKET	1	161	OR74588	BUSHING	2
100a	SC10259	TORX WRENCH	1	162	OR74589	HAND WHEEL ASSY	2
110	SC10240H	KINFE	16	163	OR94524	M8 BIG FLAT WASHER	2
111	SC10242	BLADE LOCK	16	164	OR74590	5/16-18x1/2 PAN HD SCR	2
112	SC80702	M5x8mm FLAT HD SCR	16	165	OR72950	BASE NAME PLATE	1
*	OR74608	STRAIGHT CUTTER HEAD ASS'Y (REF NO.106、107、110、111、112)	1	169	OR74591	M10x30mm SOC HEX HD SET SCR	2
106	OR74609	CUTTER HEAD PIN	6	170	OR74592	M10 FLAT WASHER	2
107	OR74610	CUTTER HEAD	1	171	OR74593	RABBET LEDGE	1
110	OR74611	KNIFE	3	174	OR74594	6-32x1/4 PAN HD SCR	1
111	OR74612	KNIFE LOCKING BAR	3	175	OR74595	POINTER	1
112	OR74613	M6x16mm SOC HEX HEAD CAP SCR	15	177	OR74596	1/2 -12x1-3/4 SOC HEX HD SCR	4
113	OR74565	3/8-24 HEX NUT	1	178	OR74597	M14 LOCK WASHER	4
114	OR90230	M10 FLAT WASHER	1	179	OR74598	BLOCK	1
115	OR74566	SHAFT	1	180	OR74599	5/16-18x3/4 SOC HEX CAP SCR	3
120	OR74567	WARNING LABEL	1	181	OR74600	SHAFT	1
121	OR74568	CUTTER HEAD GUARD	1	182	OR74601	SPRING	1
121a	OR72306	GUARD WASHER	3	183	OR74602	SPRING SHAFT	1
122	OR74563	Φ 11 RETAINING RING	1	184	OR74603	KNOB	1
123	OR74564	6x35mm SPRING PIN	1	185	OR74604	BRACKET	1
124	OR74569	SPRING	1	186a	OR93381	M8x20mm SOC HEX HD SCR	4
125	OR74570	CUTTER HEAD GUARD SHAFT	1	186b	OR90248	M8 LOCK WASHER	4
126	OR74571	5x28mm SPRING PIN	1	186c	OR90311	M8 FLAT WASHER	4
130	OR94779	M5x15mm HEX HD SCREW	2	188	OR72316	ADJUST BUSH	2
131	OR74572	KEY	1	189	OR93823	2x8mm RIVET	6
133	OR74573	SLIDE FENCE	1	190	OR74605	DEPTH GAUGE LABEL	1
137	OR74574	M10x35mm HEX HEAD SOC SCREW	2	191	OR74606	INFEED TABLE BRACKET	1
138	OR74575	M10 FLAT WASHER	2	192	OR74607	OUTER FEED TABEL BRACKET	1
143	OR74576	BASE	1	193	OR74591	M10x30mm SOC HEX HD SCR	8
144	OR74577	INFEED TABLE	1	194	OR90227	M10 LOCK WASHER	8
				195	OR90230	M10 FLAT WASHER	8

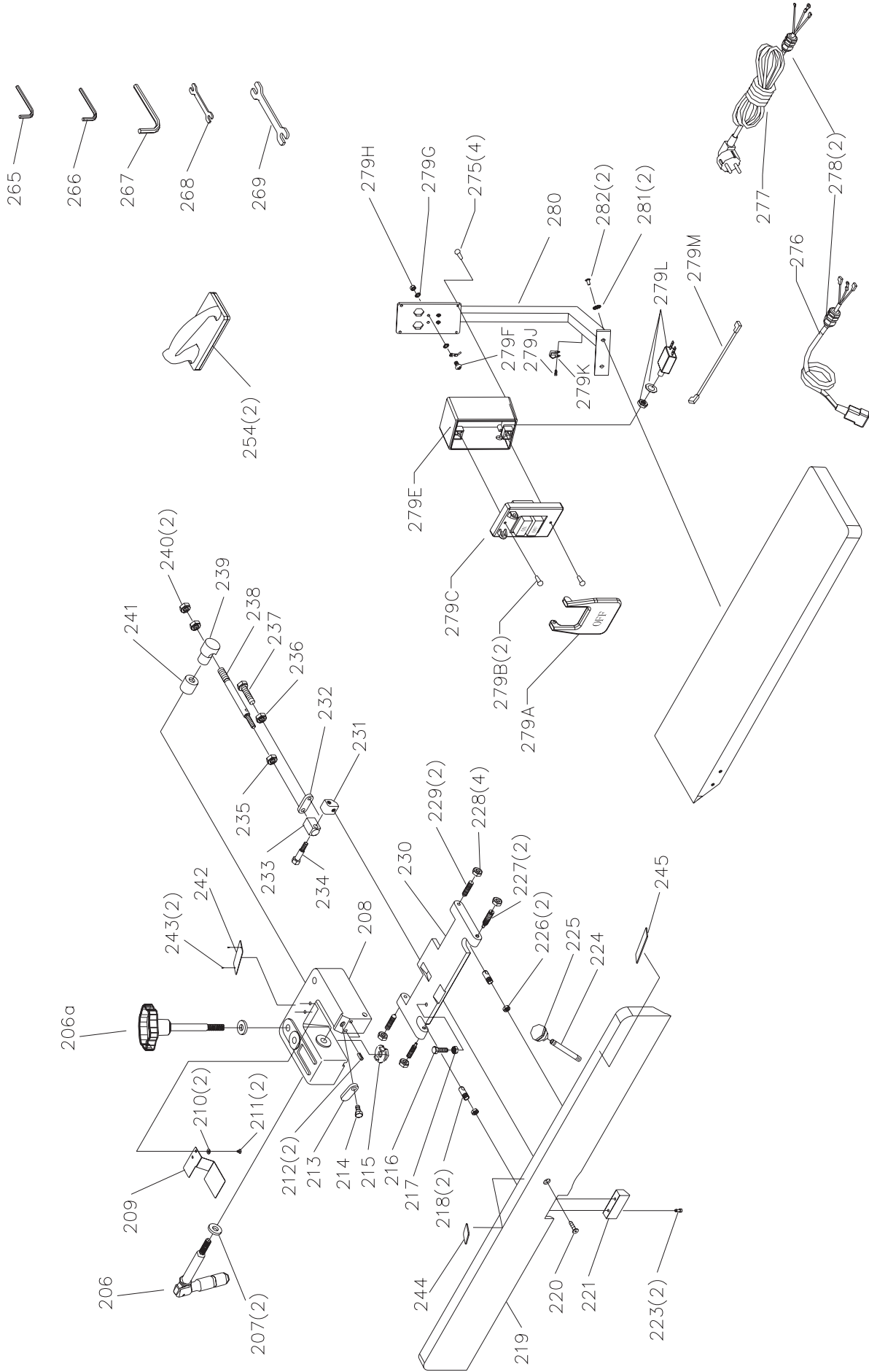

KEY NO.	PART NO.	DESCRIPTION	QTY.	KEY NO.	PART NO.	DESCRIPTION	QTY.
206	OR74614	LOCK BOLT	1	239	OR74636	BRACKET	1
206a	OR72970	FENCE KNOB	1	240	OR91767	5/8-18 HEX JAM NUT	2
207	OR91784	M14 FLAT WASHER	2	241	OR74637	SPACER	1
208	OR74615	FENCE BRACKET	1	242	OR72971	CUTTER HEAD ROTATION LABEL	1
209	OR74616	FENCE GUARD	1	243	OR93823	2x8mm RIVET	2
210	OR90059	M6 FLAT WASHER	2	244	OR72966	ROTATION LABEL	1
211	OR74617	1/4-20x3/8 PAN HEAD SCR	2	245	OR72979	INFEED LABEL	1
212	OR74618	4x12mm SPRING PIN	2	254	OR72991	PUSH BLOCK	2
213	OR74619	TILT STOP	1	265	OR90290	3mm HEX WRENCH	1
214	OR74620	STOP SCREW	1	266	OR90291	4mm HEX WRENCH	1
215	OR92974	LOCK NUT	1	267	OR91728	5mm HEX WRENCH	1
216	OR74621	5/16-18x1-1/4 HEX HD SCR	1	268	OR72992	8x10mm OPEN END WRENCH	1
217	OR74640	5/16-18 HEX NUT	1	269	OR93975	12x14mm OPEN END WRENCH	1
218	Or74622	BOLT	2	275	OR91828	M4x16mm ROUND HD TAP SCR	4
219	OR74623	GRANITE FENCE	1	276	OR74638	SWITCH CORD	1
220	OR74624	5/16-18x1-3/4 SOC HEX CAP SCREW	1	277	OR70142	POWER CORD	1
221	OR74625	PROTECTION	1	278	OR70141	STRAIN RELIEF (7P-2)	2
223	OR91758	M6x15mm SOC HEX CAP SCR	2	*	OR70143	SWITCH ASSY	1
224	OR74626	KNOB SHAFT	1	279A	OR91040	SWITCH PADDLE	1
225	OR74627	KNOB	1	279B	OR74639	M4x20mm ROUND HD TAP SCR	2
226	OR74641	1/2-20 HEX NUT	2	279C	OR90343	SWITCH	1
227	OR74628	BOLT	2	279E	OR91063	SWITCH BOX	1
228	OR74642	3/8-16 HEX NUT	4	279F	OR90507	M5x8mm PAN HD SCR	2
229	OR74629	BOLT	2	279G	OR90362	M5 EXT TOOTH WASHER	4
230	OR74630	FENCE TILT PLATE	1	279H	OR90381	M5 HEX NUT	2
231	OR74631	HANDLE NUT	1	279J	OR90507	M5x10mm PAN HD SCR	1
232	OR74632	LINK PLATE	1	279K	OR72989	CABLE CALMP	1
233	OR74633	CONNECTOR BLOCK	1	279L	OR72987	RESET SWITCH	1
234	OR74634	SCREW	1	279M	OR70140	JUMPER WIRE (BLACK)	1
235	OR74643	7/16-20 HEX NUT	1	280	OR72988	SWITCH FIXING	1
236	OR74644	5/16-18 HEX NUT	1	281	OR94793	M6 EXT TOOTH WASHER	2
237	OR74645	5/16-18x1-3/4 HEX HD SCR	1	282	OR91758	M6x15mm SOC HEX HD SCR	2
238	OR74635	SHAFT	1				

◆ NOTES ◆



STEEL CITY TOOL WORKS

www.steelcitytoolworks.com

1-877-SC4-TOOL
(1-877-724-8665)

5 Year Warranty

