

ENG

USER MANUAL

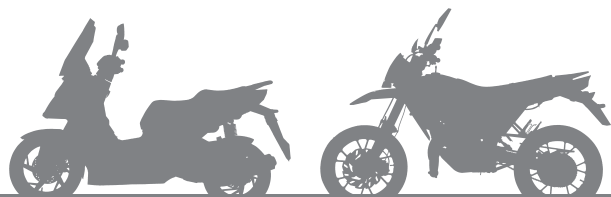

INTRODUCTION

Thanks for your purchasing of this vehicle. This model is designed for safety, built for durability, and perfected for daily street use. The unique vehicle design, enrich of stylish and peronality, represents your outstanding taste and favor to pursue the state of the art living attitude.

This manual describes the correct usage of this motorcycle including safety riding, simple inspection methods and so on. For a more comfortable and safety riding, please read this manual carefully. If any questions concerning the operation or maintenance of your vehicle, please consult a dealer.

IMPORTANT MANUAL INFORMATION

In this manual with some important information is distinguished by the following notations:

WARNING

It is **WARNING** instructions that need to follow, failure of follow could be end in result severe injury or lead to death to the operator.

CAUTION

A **CAUTION** indicates with special precautions to avoid damage to the vehicle.

CAUTION

- Please always put this manual with vehicle for rider maintenance/ dealer tracking of service records even if vehicle is being sold.
- This manual contains the most of the vehicle information, however, the maker will continually improve it's product design and quality that lead to difference between the manual and vehicle . If you have any questions concerning this manual, please consult your dealer.

WARNING

FOR YOUR OWN SAFETY, PLEASE READ THIS MANUAL CAREFULLY BEFORE OPERATION THIS VEHICLE. ONLY OPERATE THE VEHICLE UNTIL YOU HAVE COMPLETELY AWARE OF ADEQUATE KNOWLEDGE OF CONTROLS AND OPERATION FEATURE AND YOU HAVE BEEN TRAINED IN SAFE AND PROPER RIDING TECHNIQUES. PERIODIC INSPECTIONS, WELL MAINTENANCE AND GOOD RIDING SKILLS, WILL ENSURE YOUR SAFETY RIDING AND INCREASE THE PRODUCT RELIABILITY OF THIS VEHICLE.

*Product and specifications are subject to change without notice.

IMPORTANT MANUAL INFORMATION

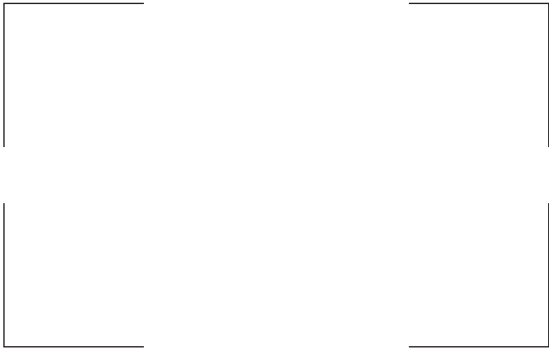

Dealer label here

TABLE OF CONTENTS

SAFETY INFORMATION	5	Starting the engine.....	22	Replacing the fuse.....	39
Other safety riding points.....	6	Starting off.....	23	Lighting.....	40
Location of labels.....	8	Acceleration and deceleration.....	23	Headlight bulbs.....	40
DESCRIPTION	9	Braking.....	23	Front indicator.....	40
Left views.....	9	Engine break-in.....	24	Rear indicator.....	40
Right view.....	10	Parking.....	24	Tail/brake and license plate light.....	40
Controls and instruments.....	11	PERIODIC MAINTENANCE AND		TROUBLESHOOTING	41
INSTRUMENT AND CONTROL		MINOR REPAIR	25	Troubleshooting chart.....	42
FUNCTIONS	12	Owner's tool kit.....	25	CLEAN AND STORAGE	43
Main switch/steering lock.....	12	Battery cover.....	26	Clean the vehicle.....	43
Indicator and warning lights.....	13	Spark plug.....	26	Storage.....	44
Dashboard unit.....	13	Final transmission oil.....	28	SPECIFICATIONS	46
Fuel gauge.....	13	Air filter.....	29	CONSUMER INFORMATION	48
Handlebar switches.....	14	Carburetor.....	29	Identification numbers.....	48
Front brake lever.....	15	Checking the throttle cable free play.....	30	WARRANTY INFORMATION	49
Rear brake lever.....	15	Tires.....	30	MAINTENANCE SCHEDULE	50
Fuel tank cap.....	15	Rims.....	32	SERVICE PLAN	51
Fuel.....	16	Adjusting the rear brake lever free		WIRING DIAGRAM	52
2-stroke engine oil tank cap.....	16	play.....	32	SPACE FOR NOTES	53
Catalytic converter.....	17	Brake pads.....	33		
Kickstarter.....	17	Front brake fluid.....	34		
Seat.....	17	Changing the brake fluid.....	34		
Storage luggage box.....	18	Cables.....	35		
Front hook, helmet.....	18	Throttle grip and cable.....	35		
Rear carrier.....	18	Lubricating the front and rear brake			
Sidestand.....	19	levers.....	35		
PRE-OPERATION CHECKS	20	Main stand.....	36		
Pre-operation check list.....	21	Front fork.....	36		
OPERATION AND IMPORTANT		Steering.....	37		
RIDING POINTS	22	Wheel bearings.....	37		
		Battery.....	37		

SAFETY INFORMATION

THIS Vehicle ARE TWO WHEEL SINGLE TRACK VEHICLES. THE USE OF SAVETY AND OPERATION MAY IN DIFFERENT RESULT BY THE USE OF PROPER RIDING TECHNIQUES OF THE OPERATOR.

TO REMIND OF OPERATOR, WHO SHOULD KNOW THE FOLLOWING REQUIREMENTS BEFORE RIDING.

HE OR SHE SHOULD:

- WELL TRAINED AND FAMILIAR TO ALL THE ASPECTS OF Vehicle OPERATION.
- FULLY READ AND AWARE OF MAINTENANCE REQUIREMENTS THAT NOTED IN THIS OWNER'S MANUAL.
- OBTAIN QUALIFIED TRAINING & LEGAL LICENSE FOR OPERATION OF THIS VEHICLE.
- WELL AND PROFESSIONAL MAINTENANCE SERVICE FOR OPERATOR AND CERTIFICATED REPAIR SHOP/DEALER TO ACQUIRE GOOD MECHANICAL CONDITIONS OF VEHICLE.

Safe riding

- Always pre-check your vehicle before riding is key point to prevent an accident.
- Please follow the maximum loads limited of operator and passenger.
- Most of accident on the motorists is caused by automobile driver who "failure to recognize out the vehicle" and caused mobile/vehicle accidents. Therefore, to make yourself conspicuous appear to public will be very effective in reducing the change of this kind of accidents.

Therefore:

- Wear a brightly colored and protective clothes/Jacket
- Operate the turning signals before turning and slow down the Speed when approaching and passthrough the intersection
- Keep proper distance with other Motorists, and let them aware of your location
- Know your skills and limits

- Never lend your vehicle to others who not qualified for riding
- Always follow the legal speed limit on the vehicle and traffic law
- The posture of the operator and passenger is important for proper control. properly riding posture can Keep vehicle in balance while riding.
 - Operator should sit up-right with two hand hold on handle bar, foot on floorboard while driving.
 - Passenger should make sure that he/she can firmly hold on grip or operator with foot step on footrest.
- Driving after Alcohol drink or other illegal drugs is strictly prohibited.
- This vehicle is designed for onroad use only. It is not suitable for off-road use.

Protective clothing

Properly clothing yourself will keep you safety from potential accidents:

- Always wear an approved helmet.
- With face shield to protect your eye from dust and rain drop.

SAFETY INFORMATION

- The wear of proper jacket, shoes, groves etc., can be better protection, reducing the degree of injury from un-expected accident.
- Never wear loose-fitting clothes, otherwise they could catch on the control levers or wheels and cause injury or an accident.
- Never touch the engine or exhaust system during or after operation. They become very hot and can cause burns. Always wear protective clothing that covers your legs, ankles, and feet.

Modifications

Modifications made to this vehicle that not approved by maker, or the removal of original equipment, may let vehicle unsafe for use and cause severe personal injury. Modifications may also make your vehicle illegal touse.

Loading and accessories

Adding accessories or cargo to your vehicle may cause the different on the weight distribution of vehicle and influence on the steering & balance.

It may cause possibility of an accident, please extremely caution and follow below limitation when you equipped with accessories. Below are some general or accessories. Here are some guidelines to follow if loading cargo or adding accessories to your vehicle.

Loading

The total weight of the operator, passenger, accessories and cargo must not exceed the maximum load limit..

**Maximum load
(not include the vehicle):
158kg**

When loading within this weight limit, keep the following in mind:

- Cargo and accessory weight should be kept as low and close to the vehicle as possible. Make sure to distribute the weight as evenly as possible on both sides of the vehicle to minimize imbalance or instability.
- Make sure that accessories and cargo are securely attached to vehicle before riding

- Never attach any large or heavy items to the handlebar, front fork, or front fender. Such items can create unstable handling or a slow steering response.

Accessories

Genuine accessories have been specifically designed for use on this vehicle. If need, please contact with dealer for detail. Since the maker can not test all other accessories , you must personally be responsible for the proper selection, installation and use of non-OEM accessories.

Keep the following guidelines in mind, when mounting accessories.

- Never install accessories or carry cargo that would influence on the ground clearance, limit suspension travel, steering, or obscure lights or turning lights, reflectors.
- Accessories on the handle bar/front suspension area will cause bad influence on steering the vehicle. if you will install accessories, please keep it as light in weight and not interfere on steering the vehicle.

SAFETY INFORMATION

- This vehicle is for On-Road transportation purpose only, please do not install any of extended cargo carrier as sulky, that will make vehicle unstable in cross winds and vehicle turns.
 - While equip with electrical accessories, please consult with qualified stores, to make sure such items will not exceed the capacity of the vehicle's electrical system. Unproper install of such items may cause a dangerous loss of lights, lower engine power or even damage the vehicle.
- Gasoline and exhaust gas**
- GASOLINE IS HIGHLY FLAMMABLE:
 - Always turn the engine off when refueling.
 - Take care not to spill any gasoline on the engine (hot) or exhaust system when refueling.
 - Do not smoke or use Mobile phone while re-fueling.
 - Never start the engine or let it run for any length of time in a closed area. The exhaust fumes are poisonous and may cause loss of consciousness and death within a short time.
 - Always turn the engine off before leaving the vehicle and remove the key from the main switch. When parking the vehicle, please note the following:
 - The engine and exhaust system remain hot, therefore, park the vehicle in a place where pedestrians or children are not likely to touch these hot areas.
 - Do not park the vehicle on a slope or soft ground, otherwise it may fall over.
 - Do not lay your vehicle to near flammable place.
 - In case of swallow any gasoline, or gasoline get into your eyes, please see your doctor immediately. Keep away the gasoline to your skin and water.

Other safe-riding points

- Turn the signal before making turns.
- When raining or across on run on the wet road, Iron Plates, keep your speed low, slightly using braking to avoid slipping or even fall down.
- Be careful when passing parked cars. A driver might not see you and open a door in your path.

SAFETY INFORMATION

LOCATION OF LABEL

1. Label, anti-tampering

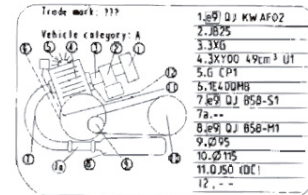
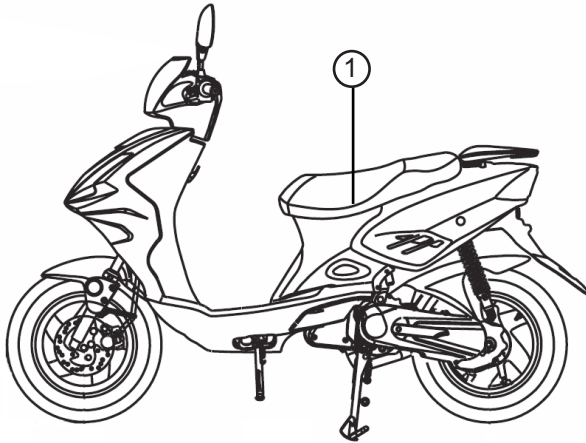

Symbol image

LEFT VIEW

1. Front wheel
2. Front brake caliper
3. Front turn signal light
4. Helmet holder
5. Storage compartment
6. Battery
7. Rear turn signal light
8. Rear wheel
9. Adjusting nut
10. Air filter element
11. Kickstarter
12. Pedal
13. Sidestand

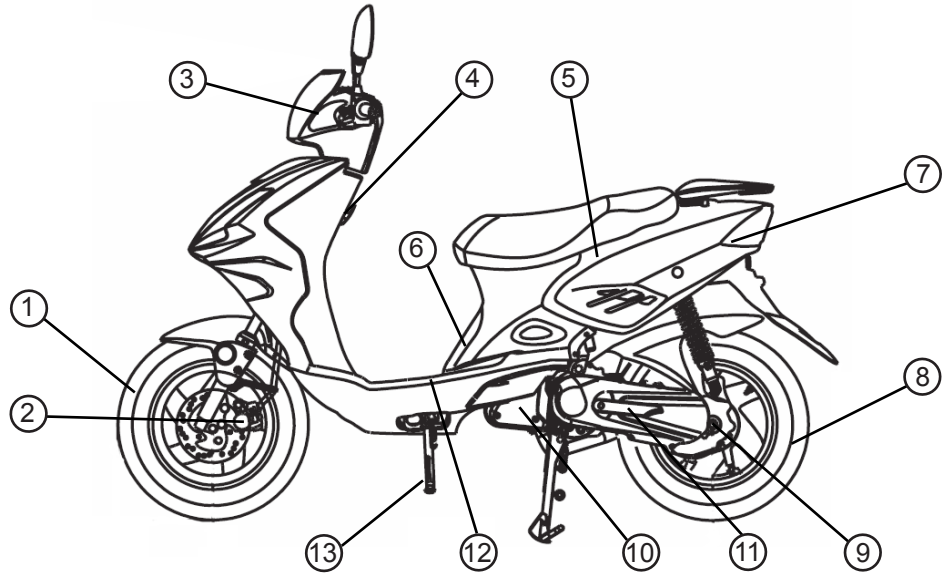

RIGHT VIEW

- 14. Tail/brake light
- 15. Carrier
- 16. 2-stroke engine oil tank cap
- 17. Seat
- 18. Fuel tank cap
- 19. Headlight
- 20. Spark plug
- 21. Mainstand
- 22. Muffler

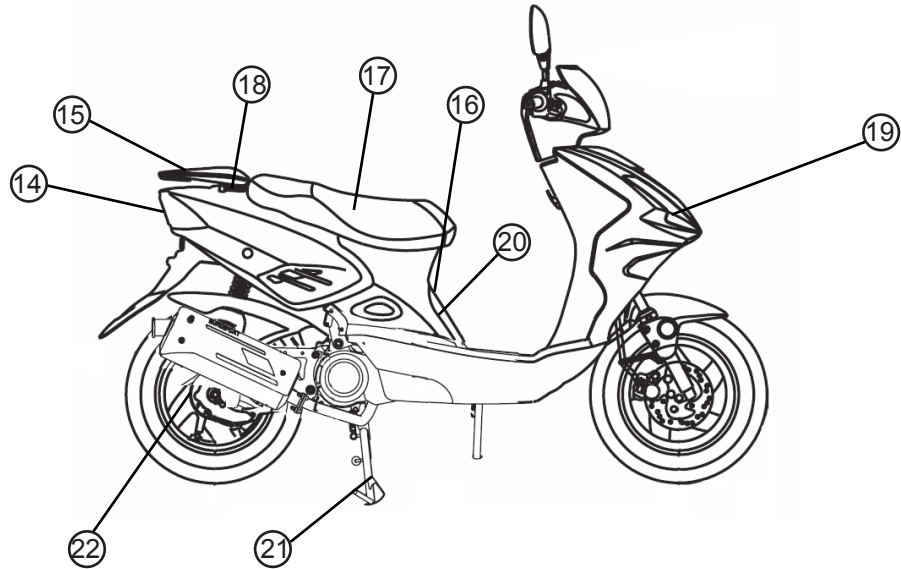

CONTROLS AND INSTRUMENTS

- 23. Rear brake lever
- 24. Left handlebar switches
- 25. Speedometer unit
- 26. Fuel gauge
- 27. Right handlebar switches
- 28. Front brake lever
- 29. Throttle grip
- 30. Main switch/steering lock

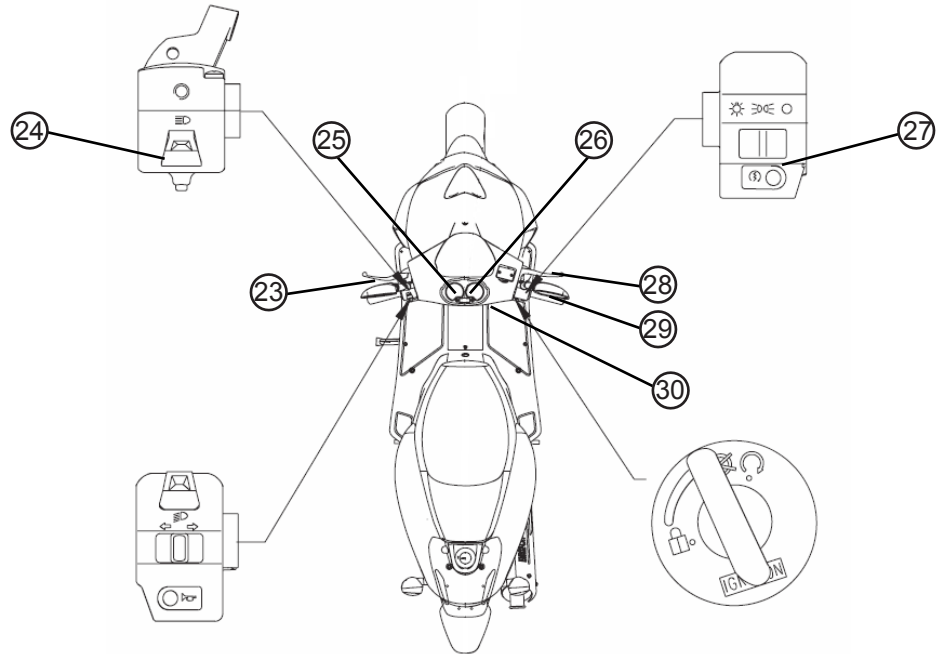

INSTRUMENT AND CONTROL FUNCTIONS

MAIN SWITCH/STEERING LOCK/ SEAT OPEN

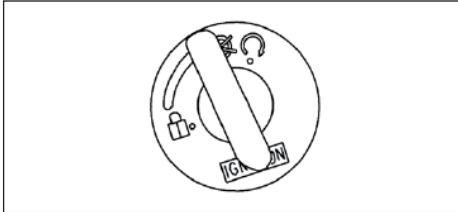

The main switch/steering lock controls the ignition and lighting systems, and also used to lock the steering, open the lugg-box. The various positions are described as below.

ON

All electrical circuits are supplied with power, the engine can be started. The key cannot be removed.

OFF

All electrical systems are off. The key can be removed.

LOCK

The steering is locked, and all electrical systems are off. The key can be removed.



To lock the steering

1. Turn the handlebars all the way to the left.
2. Push the key in and turn it to the  position while still pushing it.
3. Remove the key.

To unlock the steering



Push the key in and then turn it to  position while still pushing it.

⚠ WARNING

Never turn the key to  or , while the vehicle is moving, otherwise the electrical systems will be switched off, which may result in loss of control or an accident. Make sure that the vehicle is stopped before turning the key.

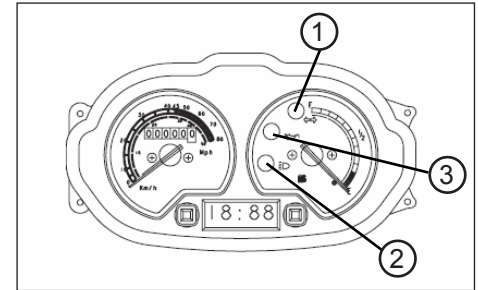
INDICATOR AND WARNING LIGHTS



1. Turn signal indicator light 
2. High beam indicator light 
3. 2-stroke engine oil level warning light 

HIGH BEAM INDICATOR LIGHT

This indicator light comes on when the high beam of the headlight is switched on.

INSTRUMENT AND CONTROL FUNCTIONS

2-STROKE ENGINE OIL LEVEL

WARNING LIGHT

The warning light comes on when the when the engine oil level in the 2-stroke engine oil tank is low during operation. If the warning light comes on during operation, check the oil level and fill the oil tank with an 2- stroke engine oil. The warning light should go off after the 2-stroke engine oil tank has been refilled.

CAUTION

Do not operate the vehicle until you know that the 2-stroke engine oil level is sufficient. Lack of engine oil will damage the engine.

⚠ WARNING

Please note that the engine oil warning light is model dependent. If your vehicle has no engine oil warning you must check the oil level before each ride..

DASHBOARD UNIT

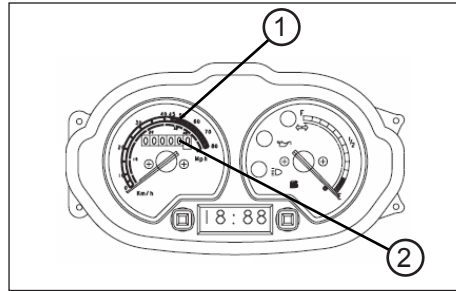

1. Odometer
2. Speedometer

The dashboard unit is equipped with a speedometer and an odometer. The speedometer shows the riding speed. The odometer shows the total distance traveled.

FUEL GAUGE

The fuel gauge indicates the amount of fuel in the fuel tank. The needle moves towards “E” (Empty) as the fuel level decreases. When the needle reaches “E”, refuel as soon as possible.

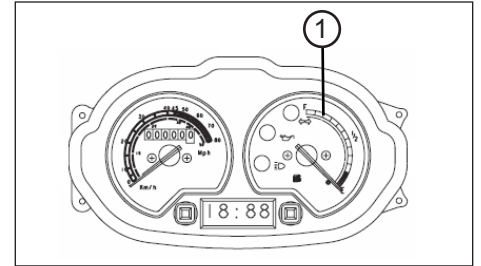

1. Fuel gauge



CAUTION

Be take care not let the fuel tank to fully empty it-self, that cause engine can not run it-self anymore.

INSTRUMENT AND CONTROL FUNCTIONS

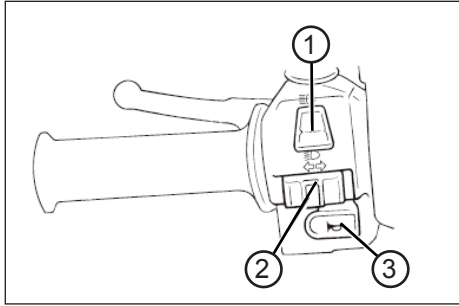
HANDLEBAR SWITCHES - LEFT



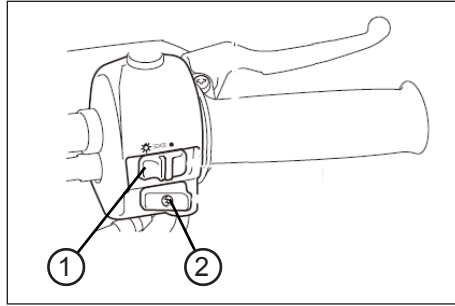

1. Dimmer switch 
2. Turn signal switch 
3. Horn switch 

HANDLEBAR SWITCHES - RIGHT



1. Light switch 
2. Start switch 



TURN SIGNAL SWITCH

Set this switch to  for the high beam and to  for the low beam.



HORN SWITCH

Press this  switch to sound the horn.

TURN SIGNAL SWITCH

To signal a right-hand turn, push this switch to . To signal a left-hand turn, push this switch to . When released, the switch returns to the center position. To cancel the turn signal lights, push the switch in after it has returned to the center position.

LIGHTSWITCH ●

Turning the light switch to  turns on the position light, meter light and taillight. Turning the light switch to , turns the headlight on also.

START SWITCH

Push this switch  (pull the brake lever at same time) to start the engine.

CAUTION

Before starting the vehicle check the notes in the user manual.

INSTRUMENT AND CONTROL FUNCTIONS

BRAKE LEVER RIGHT - FRONT BRAKE

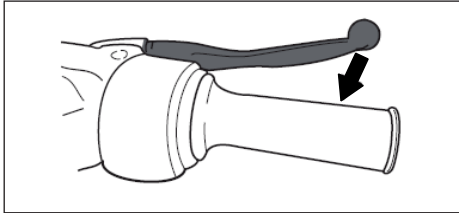

The front brake lever is located on the right handlebar grip. To apply the front brake, pull this lever toward the handlebar grip.

BRAKE LEVER LEFT - FRONT BRAKE

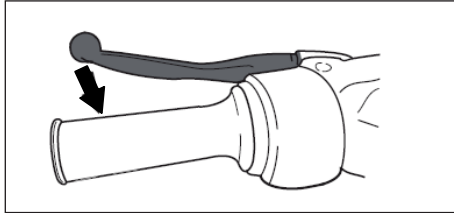

The rear brake lever is located on the left handlebar grip. To apply the rear brake, pull this lever toward the handlebar grip.

FUEL TANK CAP

To remove the fuel tank cap (1)
Turn it 1/4 turn counterclockwise. The lock will be released and the fuel tank cap can be removed.

To install the fuel tank cap (1)
Push the fuel tank cap into position. Turn the cap clockwise to the original position.

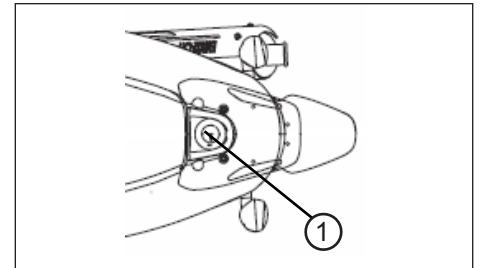

CAUTION

Make sure that the fuel tank cap is properly closed and locked before riding.

INSTRUMENT AND CONTROL FUNCTIONS

FUEL

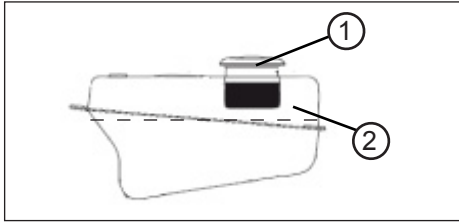

1. Fuel tank filler tube
2. Fuel level

Make sure that there is sufficient fuel in the tank. Fill the fuel tank to the bottom of the filler tube as shown.

⚠ WARNING

- Do not overfill the fuel tank, otherwise it may overflow when the fuel warms up and expands.
- Avoid spilling fuel on the hot engine.

CAUTION

Immediately wipe off spilled fuel with a clean, dry, soft cloth, since fuel may damage the painted surfaces or plastic parts.

**Regular unleaded gasoline only.
Recommended fuel: 95 oct
5l +/- 0,2 l**

**!!CAUTION!!
BIOETHANOL E10 IS NOT SUITABLE**

2-STROKE ENGINE OIL TANK CAP

1. Remove the 2-stroke engine oil tank cap (1) by pulling it off.
2. Install the 2-stroke engine oil tank cap (1) by pushing it into the oil tank opening.

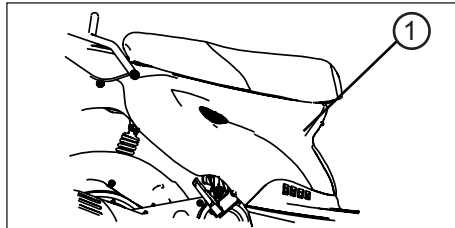

CAUTION

Make sure that the 2-stroke engine oil tank cap is properly installed before riding the vehicle.

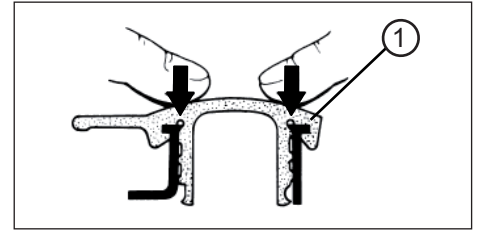

⚠ WARNING

At each refuelling you have to control the engine oil.
Capacity: 0.85 l

**Recommendation:
Castrol Actevo X-Tra Vehicle
or
Castrol Power 1 Racing 2T**

INSTRUMENT AND CONTROL FUNCTIONS

CATALYTIC CONVERTER

This model is equipped with a catalytic converter in the exhaust system.

⚠ WARNING

The exhaust system is hot after operation. Make sure that the exhaust system has cooled down before doing any maintenance work.

CAUTION

The following precautions must be observed to prevent a fire hazard or other damages.

- Use only unleaded gasoline. The use of leaded gasoline will cause unreparable damage to the catalytic converter.
- Never park the vehicle near possible fire hazards such as grass or other materials that easily burn.
- Do not allow the engine to idle too long.

KICKSTARTER

To start the engine, move it down lightly with your foot until the gears engage, and then push it down smoothly but forcefully.

CAUTION

At the same time you have to pull the right brake lever to start the vehicle.

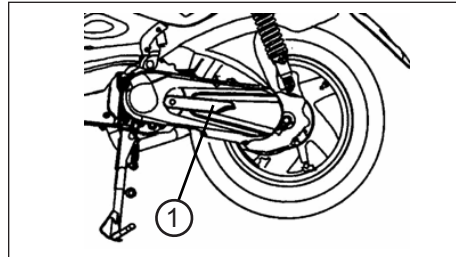

1. Kickstarter lever

SEAT

To open the seat

1. Place the vehicle on the center-stand.
2. Insert the key into the rear lock, and then turn the key clockwise to "OPEN" the seat.

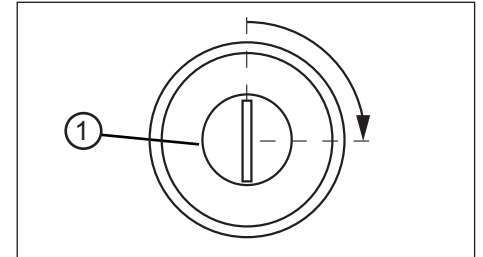

CAUTION

Do not push inward when turning the key.

INSTRUMENT AND CONTROL FUNCTIONS

3. Fold the seat up.

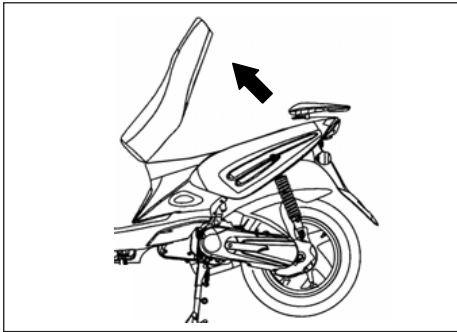

To close the seat

1. Fold the seat down, and then push it down to lock it in place.
2. Remove the key from the main switch if the vehicle will be left unattended.

CAUTION

- When you close the seat by force or strike, parts can be damaged.
- Make sure that the seat is locked before driving or when you park the vehicle.

STORAGE LUGGAGE BOX

There is a storage compartment (1) under the seat.

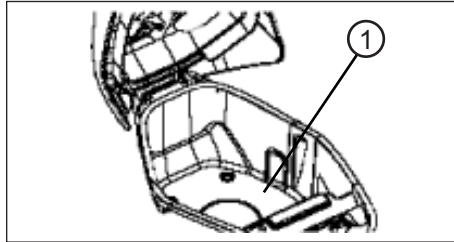

CAUTION

- Since the storage luggage box will accumulate heat by the heat of sun and engine, please do not put anything that sensitive to the heat.
- Since the storage luggage box may get wet while the vehicle is being washed, please store the related objects if need with plastic bag to prevent it from getting wet.
- Do not put anything valuable or breakable objects in the storage luggage box.

FRONT HOOK, HELMET

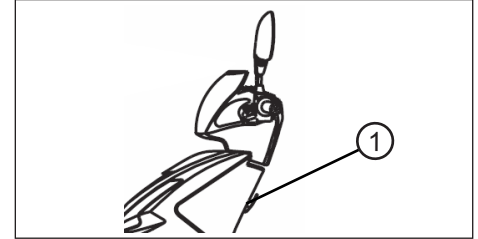

CAUTION

Do not exceed the load limit of 1 kg for the front Hook (1).

REAR CARRIER

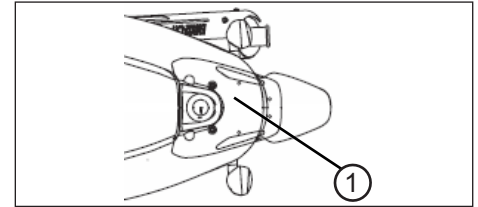

CAUTION

Do not exceed the load limit of 5kg for the carrier (1).

INSTRUMENT AND CONTROL FUNCTIONS

SIDESTAND

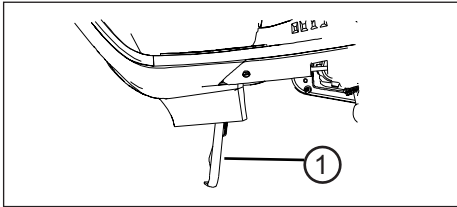

The side stand (1) is located on the left side of the Vehicle. Release the side stand by using your feet to step on the bracket of side stand to up-right position to stand the vehicle.

CAUTION

- The side stand with auto-rebound system. Make sure your vehicle have been park well are stable enough to stand the vehicle.
- Please avoid to use side stand to park the vehicle on the slope, soft land or un-flat ground.

PRE-OPERATION CHECKS

The condition of a vehicle is the owner's responsibility. The operator should check the vehicle by simple but thorough inspection, to make sure of vehicle condition, quick inspect some key and important parts, to prevent the vehicle from serious consequence/accident. Please carefully check the following points before each ride.

CAUTION

Pre-operation checks should be made each time the vehicle is used. Such an inspection can be accomplished in a very short time; and the added safety it assures is more than worth the time involved.

WARNING

**If any item in the Pre-operation check list is not working properly , have it inspected and repaired before operating the vehicle. If failed to be corrected by yourself, please turn to repair shop immediately.
If failed to be corrected by yourself, please turn to repair shop immediately.**

PRE-OPERATION CHECKS

PRE-OPERATION CHECK LIST

CHECKPOINT	TO VERIFY
Fuel	<ul style="list-style-type: none"> • Check fuel level in fuel tank. • Refuel if necessary. • Check fuel line for leakage.
2-stroke engine oil	<ul style="list-style-type: none"> • Check oil level in oil tank. • If necessary, add recommended oil to specified level. • Check vehicle for oil leakage.
Final transmission oil	<ul style="list-style-type: none"> • Check vehicle for oil leakage.
Front brake	<ul style="list-style-type: none"> • Check operation. • If soft or spongy, have dealer bleed hydraulic system. • Check brake pads for wear. • Replace if necessary. • Check fluid level in reservoir. • If necessary, add recommended brake fluid to specified level. • Check hydraulic system for leakage.
Rear brake	<ul style="list-style-type: none"> • Check operation. • Lubricate cable if necessary. • Check lever free play. • Adjust if necessary.
Throttle grip	<ul style="list-style-type: none"> • Make sure that operation is smooth. • Check cable free play. • If necessary, have dealer adjust cable free play and lubricate cable and grip housing.
Wheels and tires	<ul style="list-style-type: none"> • Check for damage. • Check tire condition and tread depth. • Check air pressure.
Brake levers	<ul style="list-style-type: none"> • Make sure that operation is smooth. • Lubricate lever pivoting points if necessary.
Main stand	<ul style="list-style-type: none"> • Make sure that operation is smooth. • Lubricate pivot if necessary.
Chassis fasteners	<ul style="list-style-type: none"> • Make sure that all nuts, bolts and screws are properly tightened. • Tighten if necessary.
Instruments, lights, signals and switches	<ul style="list-style-type: none"> • Check operation • Correct if necessary

OPERATION AND IMPORTANT RIDING POINTS

⚠ WARNING

- Before riding the vehicle, please make sure that you are fully familiar with all operating controls & their functions before riding. To consult a dealer shop if you not thoroughly understand.
- Please do not start the engine in a closed area, the exhaust air are poisonous, and inhaling them can cause loss of consciousness and even death in short time.



STARTING THE ENGINE

CAUTION

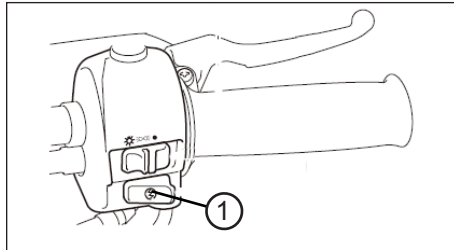
Note the point „Engine break in“ before you start to riding the vehicle.



Starten mit dem Elektrostarter

- Turn the key to ON .
- Pull the right brake lever otherwise the vehicle will not start.
- Push the start switch button  (1) for a few seconds.

CAUTION

Do not crank the engine more than 5 seconds on any one attempt.

Starten mit dem Kickstarter

- Turn the key to ON .
- Pull the right brake lever otherwise the vehicle will not start.
- Unfold the kickstart lever (1) and push with your foot down until you see a noticeable resistance.
- Then kick the kickstarter evenly and powerfully downwards.

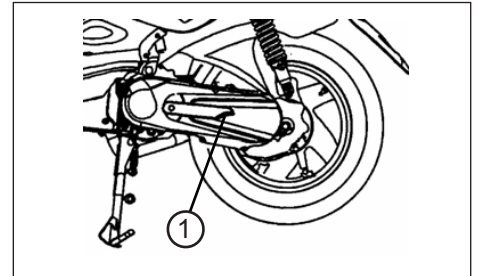

OPERATION AND IMPORTANT RIDING POINTS

CAUTION

- The engine starts immediately upon actuation of the starter, then wait a few seconds before you try to start it again. Each starting process should be as short as possible in order to save battery and the starter.
- The vehicle must periodically (recommended weekly) start with the kick starter, otherwise the grease can gum up the kick starter gear and the kick starter not to operate.

STARTING OFF

CAUTION

Before starting off, allow the engine to warm up to avoid damages.

1. While pulling the rear brake lever with your left hand and holding the carrier with your right hand, push the vehicle off the main stand..

2. Sit astride the seat, and then adjust the rear view mirrors.

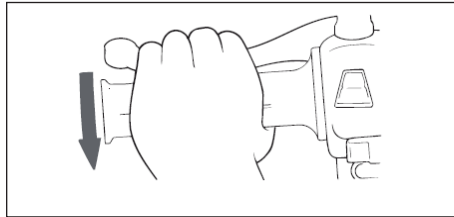

3. Switch the turn signal on to the direction you wish to turn.
4. Check for oncoming traffic, and then slowly turn the throttle grip (on the right) in order to take off.
5. Switch the turn signal off.

ACCELERATION AND DECELERATION

The speed can be adjusted by opening and closing the throttle. To increase the speed, turn the throttle grip in direction (a). To reduce the speed, turn the throttle grip in direction (b).

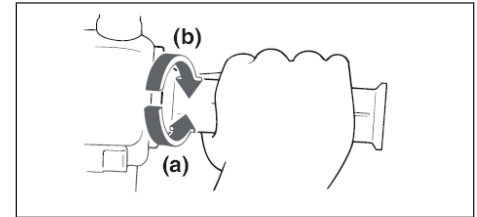

BRAKING

1. Close the throttle completely.
2. Apply both front and rear brakes simultaneously while gradually increasing the pressure.

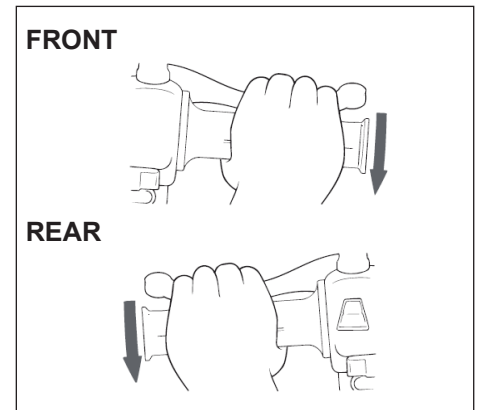

OPERATION AND IMPORTANT RIDING POINTS

WARNING

- **Avoid braking hard or suddenly, otherwise the vehicle may skid**
- **Railroad crossings, streetcar rails, iron plates on road construction sites, and manhole covers become extremely slippery when wet. Therefore, slow down when approaching such areas and cross them with caution.**
- **Keep in mind that braking on a wet road is much more difficult.**
- **Ride slowly down a hill, as braking downhill can be very difficult.**

ENGINE BREAK IN

Since the engine is brand new, do not put an excessive load on it for the first 1000 km. The various parts in the engine wear and polish themselves to the correct operating clearances.

During this period, prolonged full-throttle operation or any condition that might result in engine overheating must be avoided.

CAUTION

If any engine trouble should occur during the engine break-in period, immediately have a dealer check the vehicle.

PARKING

When parking, stop the engine, and then remove the key from the main switch.

WARNING

Since the engine and exhaust system can become very hot, park in a place where pedestrians or children are not likely to touch them.

Do not park on a slope or on soft ground, otherwise the vehicle may overturn.

PERIODIC MAINTENANCE AND MINOR REPAIR

CAUTION

Most of the Safety and condition of vehicle depend on how you do the correct maintenance , periodic inspection, adjustment and lubrication. The following are contents that help the operator to do such skills on the following pages.

⚠ WARNING

Maintenance, replacement, or repair of the emission control devices and systems may be performed by any repair shop or individual that is certified and must follow the local law regulations.

If you are not familiar with maintenance work, have a dealer do it for you.

OWNER'S TOOL KIT

The owner's tool kit (1) is located inside the rear storage luggage box.

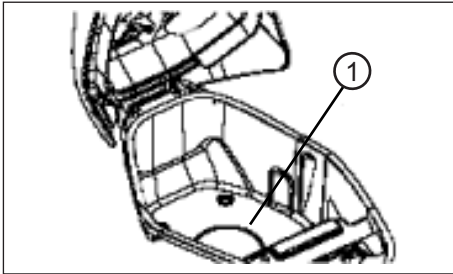

The service information included in this manual and the tools provided in the owner's tool kit are intended to assist you in the performance of preventive maintenance and minor repairs. However, additional tools such as a torque wrench may be necessary to perform certain maintenance work correctly.

CAUTION

If you do not have the tools or experience required for a particular job, have a dealer perform it for you.

⚠ WARNING

Modifications not approved by maker may cause loss of performance, excessive emissions, and render the vehicle unsafe for use. Consult a dealer before attempting any changes.

PERIODIC MAINTENANCE AND MINOR REPAIR

BATTERY COVER

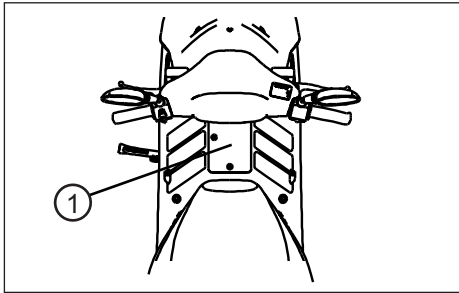

The covers (1) shown needs to be removed to perform some of the maintenance jobs described in this chapter.

To remove the cover

Remove the screws, and then take the cover off.

To install the cover

Place the cover in the original position, and then install the screws.

SPARK PLUG

The spark plug is an important engine component, which is easy to check. Since heat and deposits will cause any spark plug to slowly erode, the spark plug should be removed and checked in accordance with the periodic maintenance and lubrication chart. In addition, the condition of the spark plug can reveal the condition of the engine.

TO REMOVE THE SPARK PLUG

1. Remove cover
2. Remove the spark plug cap (1)

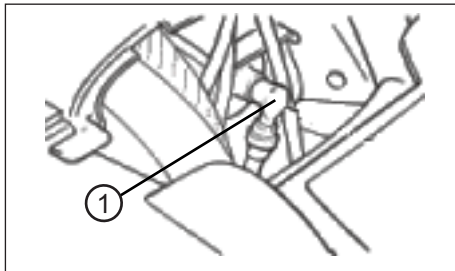

3. Remove the spark plug as shown, with the spark plug wrench (2) included in the owner's tool kit.



4. Check that the porcelain insulator (3) around the center electrode of the spark plug is a medium-to-light tan (the ideal color when the vehicle is ridden normally).

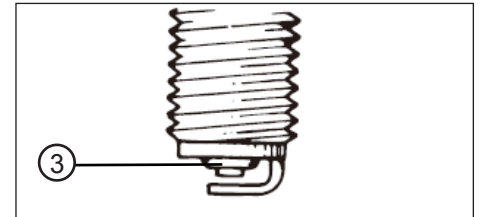

PERIODIC MAINTENANCE AND MINOR REPAIR

CAUTION

If the spark plug shows a distinctly different color, the engine could be operating improperly. Do not attempt to diagnose such problems yourself. Instead, have a dealer check the vehicle.

5. Check the spark plug for electrode erosion and excessive carbon or other deposits, and replace it if necessary.

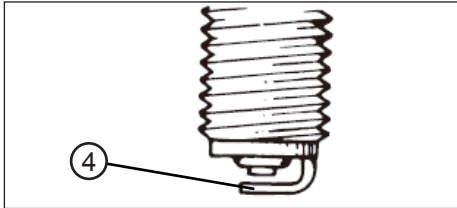

**Specified spark plug:
NGK - BR8HSA**

WARNING

Please note that no other spark plug model is allowed. Using a different spark plug model can immediately lead to engine damage.

6. Measure the spark plug gap with a wire thickness gauge and, if necessary, adjust the gap to specification. Clean the surface of the spark plug gasket and its mating surface, and then wipe off any grime from the spark plug threads.
7. Install the spark plug with the spark plug wrench, and then tighten it to the specified torque.

Spark plug gap: 0,6 - 0,7 mm

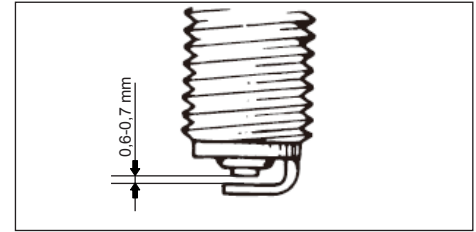

WARNING

Please note the max. torque when inserting the plug. If you do not have the ability to control you leave control of the spark plug to the dealer.

Tightening torque: 12 Nm

PERIODIC MAINTENANCE AND MINOR REPAIR

FINAL TRANSMISSION OIL

The final transmission case (1) must be checked for oil leakage before each ride. If any leakage is found, have a dealer check and repair the vehicle. In addition, the final transmission oil must be changed as follows at the intervals specified in the periodic maintenance and lubrication chart.

CAUTION

As long as the vehicle is within the warranty period the dealer is responsible to change the gear oil.

CHANGE THE FINAL TRANSMISSION OIL

1. Start the engine, warm up the final transmission oil by riding the vehicle for several minutes, and then stop the engine.
2. Place the vehicle on the main stand.
3. Place an oil pan under the final transmission case to collect the used oil.

4. Remove the oil filler cap (2) and drain bolt (3) to drain the oil from the final transmission case.

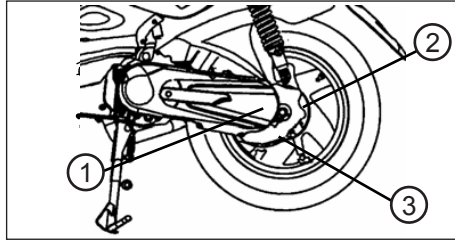

5. Install the final transmission oil drain bolt, and then tighten it to the specified torque.

Tightening torque: 18 Nm

6. Add the requested amount of the recommended final transmission oil, and then install and tighten the oil filler cap.

Recommended final transmission oil: Castrol MTX Part Synth. 80W or EP 80W-90
Oil quantity:
Full: 0,13 l / Change: 0,10 l

⚠ WARNING

- Make sure that no foreign material enters the final transmission case.
 - Make sure that no oil gets on the tire or wheel.
7. Check the final transmission case for oil leakage. If oil is leaking, check for the cause.

PERIODIC MAINTENANCE AND MINOR REPAIR

AIR FILTER

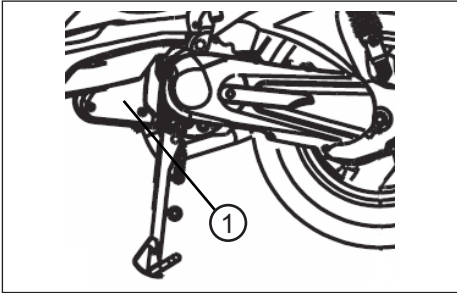

The air filter should be replaced according to the maintenance schedule. Replace the air filter more often if you drive in unusually wet or dusty areas.

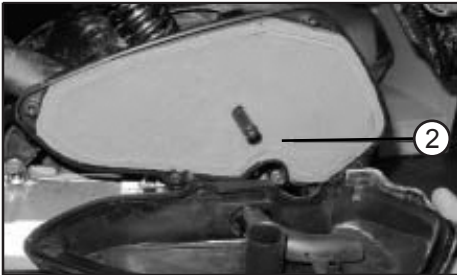

REPLACE THE AIR FILTER

1. Remove the air filter case (1).
2. Pull the air filter (2) out.
3. Replace the filter with a new one.
4. Coat the mating surfaces of the air filter case and air filter case cover lightly with grease for an airtight seal.
5. Install the air filter.
6. Install the air filter case cover by installing the screws.

CAUTION

- Make sure that the air filter element is properly seated in the air filter case.
- The engine should never be operated without the air filter element installed, otherwise the piston and/or cylinder may become excessively worn.

CARBURETOR

The carburetor is an important part of the engine and its emission control system, which requires very sophisticated adjustment. Therefore, carburetor adjustments should be left to dealer, who has the necessary professional knowledge and experience.

PERIODIC MAINTENANCE AND MINOR REPAIR

CHECKING THE THROTTLE CABLE FREE PLAY

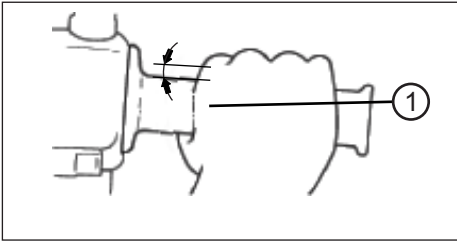

The throttle cable free play (1) should measure 1.5 ~ 3.5 mm at the throttle grip. Periodically check the throttle cable free play and, if necessary, have a dealer adjust it.

TIRES

To maximize the performance, durability, and safe operation of your vehicle, note the following points regarding the specified tires.

TIRE AIR PRESSURE

The tire air pressure should be checked and, if necessary, adjusted before each ride.

⚠ WARNING

The tire air pressure must be checked and adjusted on cold tires (i.e., when the temperature of the tires equals the ambient temperature).

The tire air pressure must be adjusted in accordance with the riding condition. If you are not familiar to this, please have dealer for help.

Tire air pressure:
Front: 2,1 bar - 2,5 bar
Rear: 2,1 bar - 2,5 bar
Total weight of rider, passenger,
cargo and accessories!

⚠ WARNING

Do not over load your vehicle, since it will increase pressure on the tire, braking, steering than original design, and may could cause damage or even lead to accident.

Allocation of your cargo and weight of your vehicle is very important for your own safety and vehicle performance. Load your cargo rmlly on vehicle and put the heaviest cargo to the center of vehicle, then distribute the weight evenly from side to side. It will keep you to have good steering after load.

Maximum load*: 158 kg

* Total weight of rider, passenger,
cargo and accessories

PERIODIC MAINTENANCE AND MINOR REPAIR

TIRE INSPECTION

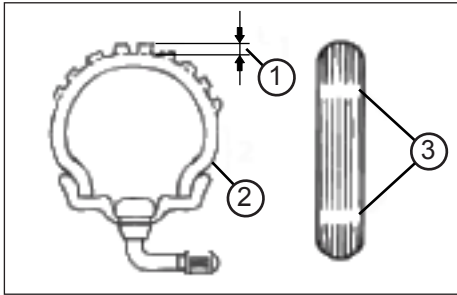

1. Tire tread depth
2. Tire sidewall
3. Tire wear indicator

⚠ WARNING

The tires must be checked before each ride. If a tire tread shows crosswise lines (minimum tread depth), if the tire has a nail or glass fragments in it, or if the sidewall is cracked, have a dealer replace the tire immediately.

CAUTION

The tread depth may vary depending on country. Observe local regulations. The values listed here are technical values and may differ from the legal values of your region.

**Minimum tire tread depth:
Front and rear: > 1,6 mm**

⚠ WARNING

- Drive with worn tire is illegal, reduces stability and can lead to loss of control over the vehicle.
- Let worn or damaged tires replaced immediately by your dealer.
- Working tires and the dealer is responsible.

DIMENSIONS TIRES/ RIMS

**Front: Rim: E12X 3.5
Tire: 120/70-12**

**Rear: Rim: E12X 3.5
Tire: 130/70-12**

Tyre type: tubless

PERIODIC MAINTENANCE AND MINOR REPAIR

RIMS

To maximize the performance, durability, and safe operation of your motorcycle, note the following points regarding the specified wheels.

- The wheel rims should be checked for cracks, bends or warpage before each ride. If any damage is found, have a dealer replace the wheel. Do not attempt even the smallest repair to the wheel. A deformed or cracked wheel must be replaced.
- The wheel should be balanced whenever either the tire or wheel has been changed or replaced. An unbalanced wheel can result in poor performance, adverse handling characteristics, and a shortened tire life.
- Ride at moderate speeds after changing a tire since the tire surface must first be “broken in” for it to develop its optimal characteristics..

ADJUSTING THE REAR BRAKE LEVER FREE PLAY

Front brake

CAUTION

There should be no free play at the brake lever end. If there is free play, have a dealer inspect the brake system.

⚠ WARNING

A soft or spongy feeling in the brake lever can indicate the presence of air in the hydraulic system. If there is air in the hydraulic system, have a dealer bleed the system before operating the motorcycle. Air in the hydraulic system will diminish the braking performance, which may result in loss of control and an accident.

Rear brake

CAUTION

Unlike the front brake lever needs to have the rear brake a game of about 10 mm. The rear brake is actuated cable. If there is no play, it may be that the brake linings drag permanently in the brake drum.

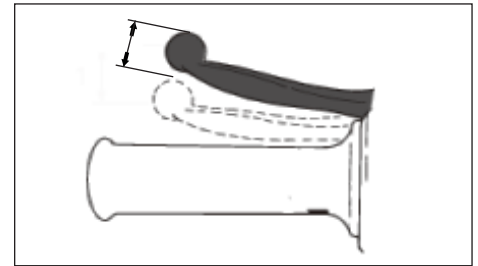

Periodically check the brake lever free play and, if necessary, adjust it as follows.

PERIODIC MAINTENANCE AND MINOR REPAIR

To increase the brake lever free play, turn the adjusting nut at the brake shoe plate in direction (A). To decrease the brake lever free play, turn the adjusting nut in direction (B).

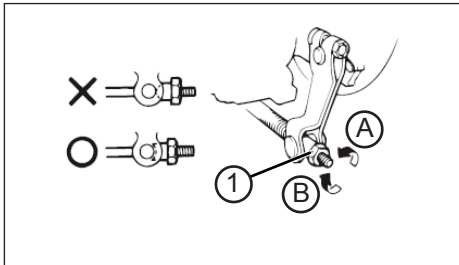

⚠ WARNING

If proper adjustment cannot be obtained as described, have a dealer make this adjustment.

BRAKE PADS

The front brake pads and the rear brake shoes must be checked for wear at the intervals specified in the periodic maintenance and lubrication chart.

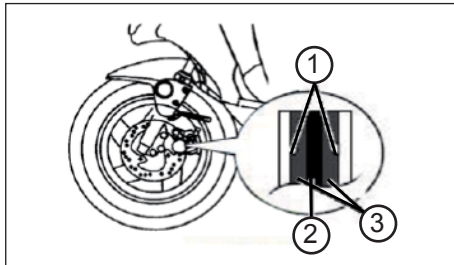

1. Wear indicator
2. Brake disc
3. Brake pad

Front brake pads

Each front brake pad is provided with wear indicators, which allows you to check the brake pad wear without having to disassemble the brake. To check the brake pad wear, check the position

of the wear indicators while applying the brake. If a brake pad has worn to the point that a wear indicator almost touches the brake disc, have a dealer replace the brake pads as a set.

Rear brake Shoes

Always check and adjust the brake lever before riding. To check the brake, check the position of the adjustable nut if the nut position reaches the end, have a dealer to replace the brake shoes as a set.

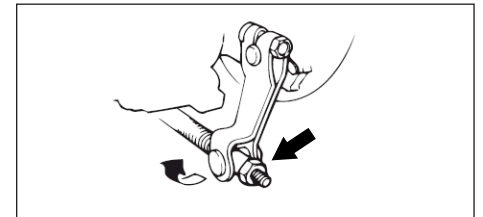

PERIODIC MAINTENANCE AND MINOR REPAIR

FRONT BRAKE FLUID

⚠ WARNING

Insufficient brake fluid may allow air to enter the brake system, possibly causing it to become ineffective. Before riding, check that the brake fluid is above the minimum level mark (1) and refill it if necessary.

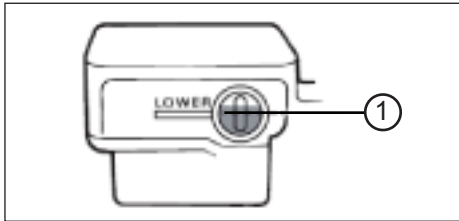

Low position brake fluid level may indicate worn brake pads and/or brake system leakage. If the brake fluid level is low, be sure to check the brake pads for wear and the brake system for leakage.

When checking the fluid level, make sure that the top of the master cylinder is level by turning the handlebars.

Use only the recommended quality brake fluid, otherwise the rubber seals may deteriorate, causing leakage and poor braking performance.

**Recommended brake fluid:
Castrol Super Disc Brake Fluid DOT 4**

- Refill with the same type of brake fluid. Mixing fluids may result in a harmful chemical reaction and lead to poor braking performance.
- Be careful that water does not enter the master cylinder when refilling. Water will significantly lower the boiling point of the fluid and may result in vapor lock.
- Brake fluid may deteriorate painted surfaces or plastic parts. Always clean up spilled fluid immediately.

- As the brake pads wear, it is normal for the brake fluid level to gradually go down. However, if the brake fluid level goes down suddenly, have a dealer check.

CHANGING THE BRAKE FLUID

⚠ WARNING

Have a dealer change the brake fluid at the intervals specified in the NOTE after the periodic maintenance and lubrication chart.

PERIODIC MAINTENANCE AND MINOR REPAIR

CABLES

Checking and lubricating

The operation of all control cables and the condition of the cables should be checked before each ride, and the cables and cable ends should be lubricated if necessary. If a cable is damaged or does not move smoothly, have a dealer check or replace it.

**Recommended lubricant:
Castrol Motorrad DWF Ölspray**

⚠ WARNING

Damage to the outer housing of cables may result in internal rusting and cause interference with cable movement. Replace damaged cables as soon as possible to prevent unsafe conditions.

THROTTLE GRIP AND CABLE

The operation of the throttle grip should be checked before each ride. In addition, the cable should be lubricated at the intervals specified in the periodic maintenance chart.

LUBRICATING THE FRONT AND REAR BRAKE LEVERS

The pivoting points of the front and rear brake levers must be lubricated at the intervals specified in the periodic maintenance and lubrication chart..

Front brake lever

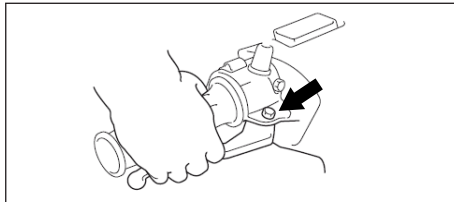

Rear brake lever

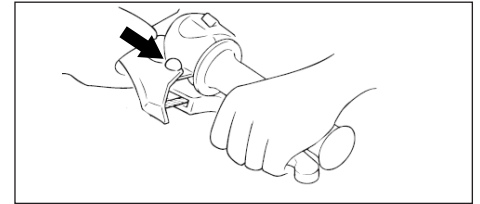

**Recommended lubricants:
Castrol Motorrad DWF oil spray**

PERIODIC MAINTENANCE AND MINOR REPAIR

MAIN STAND

CAUTION

The operation of the main stand should be checked before each ride, and the pivots and metal-to-metal contact surfaces should be lubricated if necessary.

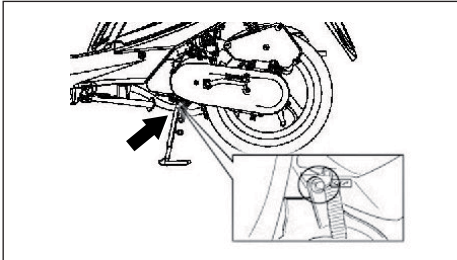

⚠ WARNING

If the main stand does not move up and down smoothly, have a dealer check or repair it.

**Recommended lubricant:
Castrol Multi Purpose Grease**

FRONT FORK

Checking the front fork

The condition and operation of the front fork must be checked as follows at the intervals specified in the periodic maintenance and lubrication chart.

**Recommended lubricant:
Castrol Motorrad DWF**

⚠ WARNING

Securely support the motorcycle so that there is no danger of it falling over.

1. Place the vehicle flat and upright from.
2. Check the inner tubes for scratches, damage and oil leakage.
3. Apply the front brake and push the handlebars several times down hard to verify the suspension of the fork.

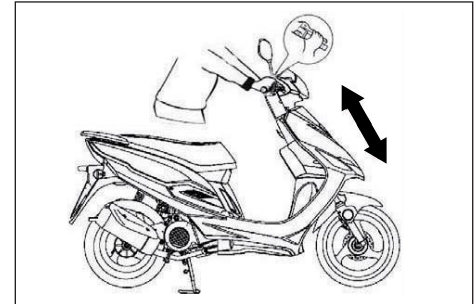

⚠ WARNING

- When damage to the fork, please contact your dealer.
- If you treat the telescopic fork with cleaning agents, make sure that they get no contact with the tires or the brakes. This can lead to dangerous accidents.

PERIODIC MAINTENANCE AND MINOR REPAIR

STEERING

Checking the steering

⚠ WARNING

Worn or loose steering bearings may cause danger. Therefore, the operation of the steering must be checked as follows at the intervals specified in the periodic maintenance and lubrication chart.

1. Place the vehicle on the center stand/suitable motorcycle stand to raise the front wheel off the ground.
2. Hold the lower ends of the front fork legs and try to move them forward and backward.
3. If any free play can be felt, have a dealer check or repair the steering.

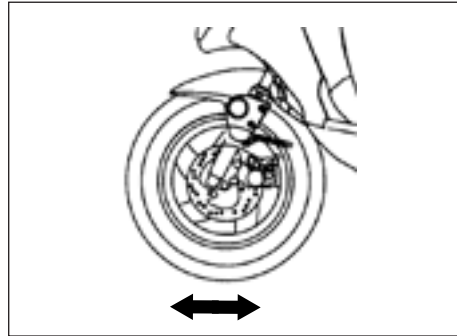

WHEEL BEARINGS

Checking the wheel bearings

The front and rear wheel bearings must be checked at the intervals specified in the periodic maintenance and lubrication chart.

CAUTION

If there is play in the wheel hub or if the wheel does not turn smoothly, have a dealer check the wheel bearings.

BATTERY

This model is equipped with a sealed-type (MF) battery, which does not require any maintenance. There is no need to check the electrolyte or to add distilled water.

⚠ WARNING

- Do not remove the battery vent seal, this can be dangerous, the battery permanently damaged.
- Battery acid is poisonous and dangerous, it contains sulfuric acid and leads to dangerous burns.
- Avoid skin, eye and clothing contact. Protect your eyes always when working near the battery.
- Upon contact with the battery acid, make immediate FIRST AID.

PERIODIC MAINTENANCE AND MINOR REPAIR

- If skin or eye contact with battery acid, rinse the affected areas with plenty of water.
- When accidentally swallowed battery acid drink large amounts of water.
- In both cases, as soon as possible, see a doctor.
- Batteries develop explosive hydrogen gas. Keep open flames, smoking materials away from the battery and make sure there is adequate ventilation when you charge a battery indoors.
- **KEEP THIS AND ALL BATTERIES OUT OF THE REACH OF CHILDREN.**

TO CHARGE THE BATTERY

Have a dealer charge the battery as soon as possible if it seems to have discharged. Keep in mind that the battery tends to discharge more quickly if the vehicle is equipped with optional electrical accessories.

TO STORE THE BATTERY

- If the vehicle will not be used for more than one month, remove the battery, fully charge it, and then place it in a cool, dry place.
- If the battery will be stored for more than two months, check it at least once a month and fully charge it if necessary.
- Fully charge the battery before installation.
- After installation, make sure that the battery leads are properly connected to the battery terminals.

WARNING

- Please contact your dealer if you are not familiar with handling the battery.

CAUTION

- Always keep the battery charged. Storing a discharged battery can cause permanent battery damage.

PERIODIC MAINTENANCE AND MINOR REPAIR

FUSE

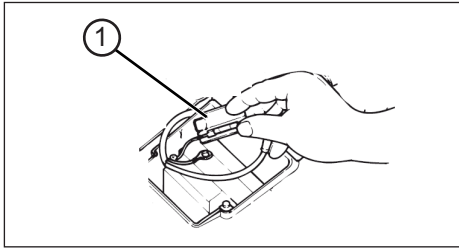

The fuse holder is located behind battery cover.

REPLACING THE FUSE

1. Turn the key to  and turn off all electrical circuits.
2. Remove the blown fuse, and then install a new fuse of the specified amperage.

**Specified fuse:
10 Amp**

WARNING

Do not use a fuse of a higher amperage rating than recommended to avoid causing extensive damage to the electrical system and possibly a fire.

3. Turn the key to  and turn on the electrical circuits to check if the devices operate.
4. If the fuse immediately blows again, have a dealer check the electrical system.

PERIODIC MAINTENANCE AND MINOR REPAIR

LIGHTING

HEADLIGHT BULBS

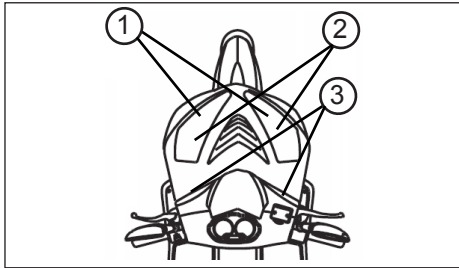

CAUTION

This model is equipped with halogen bulb headlight (1). If a headlight bulb burns out, have a dealer replace it and, if necessary, adjust the headlight beam.

This model has furthermore a LED position light (2). If the LED position light defective, please contact your dealer.

FRONT INDICATOR

If the turn signal light bulb does not come on, remove the screw of the indicator lens (3) out and replace the bulb.

REAR INDICATOR

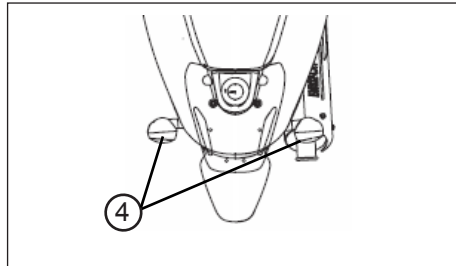

If the turn signal light bulb does not come on, remove the screw of the indicator lens (4) out and replace the bulb.

TAIL/BRAKE LIGHT AND LICENSE PLATE LIGHT

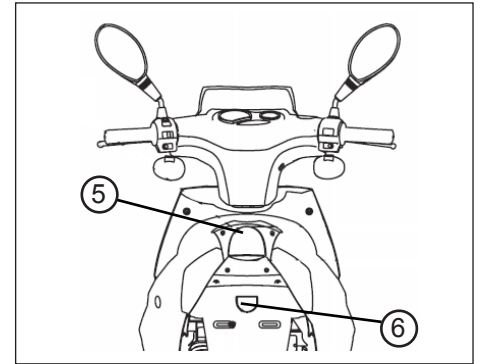

- 5. Tail/brake light
- 6. License plate light

If the tail/brake light and license plate light bulb does not come on, have a dealer check its electrical circuit or replace the bulb.

TROUBLESHOOTING

Although the vehicles receive a thorough inspection before shipment from the factory, trouble may occur during operation. Any problem in the fuel, compression, or ignition systems, for example, can cause poor starting and loss of power.

The following troubleshooting chart represents a quick and easy procedure for checking these vital systems yourself. However, should your vehicle require any repair, take it to a dealer, whose skilled technicians have the necessary tools, experience, and knowhow to service the vehicle properly.

Use only genuine replacement parts. Imitation parts may look like parts, but they are often inferior have a shorter service life and can lead to expensive repair bills.

TROUBLESHOOTING CHART

⚠️ WARNING

Keep away open flames and do not smoke while checking or working on the fuel system.

1. Fuel

Check the fuel level in the fuel tank.

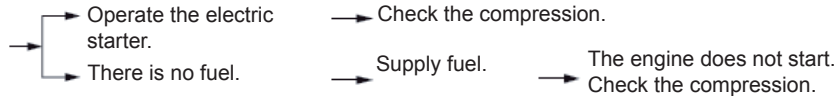

2. Compression

Operate the electric starter.

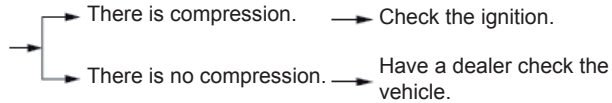

3. Ignition

Remove the spark plug and check the electrodes.

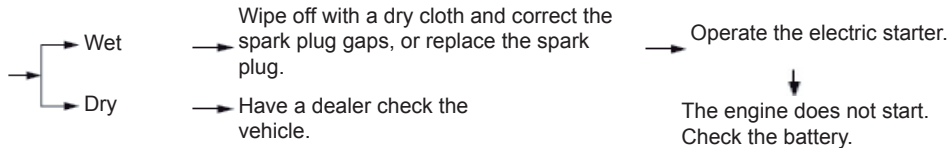

4. Battery

Operate the electric starter.

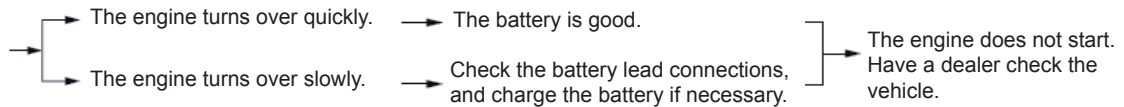

CLEAN AND STORAGE

CLEAN THE VEHICLE

Clean of the vehicle in proper and suitable way will make it attractive, extend its life and optimize the performance.

BEFORE CLEANING

1. Cover the muffler outlet with a plastic bag to prevent water to come inside. Please do it only after the
2. Closed every caps, covers, electrical connectors that are well install and water can be avoid to get into, while you do the clean job.

CAUTION

- Do not use acid-based cleaners. If such funds used for stubborn stains, so use this only occasionally, dry it immediately after and then apply a corrosion protection spray.
- Always follow the manufacturer's instructions on care and cleaning agents.

- Use best only water and mild detergent or special cleaner from the dealer to the sensitive components of the vehicle to prevent damage. Dry the plastic parts then wipe with a soft, dry cloth or sponge.
- Protect particularly plastic parts, paint, headlight glass from harsh chemicals such as fuel, rust remover, brake cleaner or similar. The use of such agents may result in malfunction, damage and affect the security itself.
- Do not use a high pressure washer or steam cleaner, causing water in storage can penetrate electrical components such as connectors or switches, lighting, ventilation hoses, brake shoes and brake linings or damage, seals, paint and other surfaces.

AFTER NORMAL USE

Remove dirt with warm water, a mild detergent, and a soft, clean sponge, and then rinse thoroughly with clean water. Use a toothbrush or bottlebrush for hard-to-reach areas.

AFTER RIDING IN THE RAIN, SEAR THE SEA OR ON SALT-SPRAYED ROADS

CAUTION

Since sea salt or salt sprayed on the roads during winter are extremely corrosive in combination with water, carry out the following steps after each ride.

- Wait until the engine / exhaust have cooled.
- Clean the vehicle with warm water and a mild detergent.
- Do not use hot water, which increases the corrosive effect of the salt.

CARE AND STORAGE

- Apply a corrosion protection spray on all metal, including chrome- and nickel-plated, surfaces to prevent corrosion.

AFTER CLEANING

- Dry the vehicle.
- To prevent rust, we recommend appropriate care to use according to manufacturer's instructions.
- Wax all painted surfaces.

Recommended Castrol care products:

Greentec Bike Cleaner
Bike polish
Motorcycle DWF oil spray

WARNING

- Make sure that there is no oil or wax on the brakes or tires. If necessary, clean the brake discs and brake linings with a regular brake disc cleaner and wash the tires with warm water and a mild detergent.
- Before operating the vehicle, test the braking performance and tires.

STORAGE

Short-term (for a few days)

- Always store your vehicle in a cool, dry place and, if necessary, protect it against dust with a vehicle cover.

WARNING

Please store the vehicle in a well air flow room with dry air if possible. A place with wet humidity will cause rust.

Long-term (for weeks)

- Clean the vehicle.
- Drain the fuel from the carburetor.
- Enter the drained fuel back into the fuel tank.
- Fill the fuel tank to completely or add if necessary a fuel stabilizer to protect the fuel tank from rusting and the fuel from degradation.

CARE AND STORAGE

Follow the steps below to cylinders, piston rings, etc. to prevent rusting.

- Remove spark plug cap and the spark plug.
- Give a teaspoon of engine oil into the spark plug hole.
- Join the Kickstarter to slow down and let the engine several times slowly rotate (thus the cylinder is oiled).
- Put the spark plug back in and put on the spark plug cap.

WARNING

To prevent damage or injury from sparking, make sure to ground the spark plug electrodes while turning the engine over.

- Lubricate all control cables and the pivoting points of all levers and pedals as well as of the side stand/main stand.
- Check and, if necessary, correct the tire air pressure, and then lift the vehicle so that both of its wheels are off the ground. Alternatively, turn the wheels a little every month in order to prevent the tires from becoming degraded in one spot.
- Cover the muffler outlet with a plastic bag to prevent moisture from entering it.
- Remove the battery and fully charge it. Store it in a cool, dry place and charge it once a month. Do not store the battery in an excessively cold or warm place [less than 0 °C (30 °F) or more than 30°C (90 °F)].

CAUTION

Make any necessary repairs before storing the vehicle.

SPECIFICATIONS

DIMENSIONS

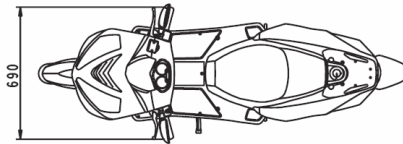
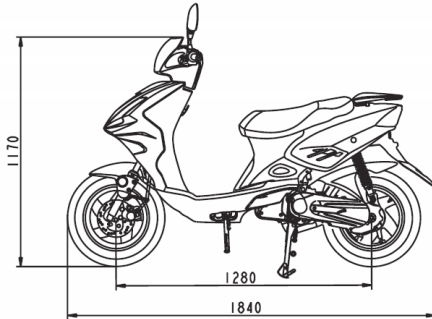

ENGINE

Engine type
Air cooled 2-stroke
Cylinder arrangement
Forward-inclined single cylinder
Displacement
49,0 cm³
Compression ratio
6.9:1
Starting system
Electric starter and kickstarter
Lubrication system
Separate lubrication
2-stroke engine oil

ENGINE OIL

Quantity: 0.85 l
recommended type:
Castrol Power 1 Racing 2T

TRANSMISSION OIL

Typ SAE 80W-90
recommended type:
Castrol MTX Part Snth. 80W
or EP 80W-90

AIR FILTER

Wet element

FUEL

Unleaded gasoline only
Capacity
5l +/- 0.2l

CAUTION

**!! BIOETHANOL FUEL -
E10 IS NOT PERMITTED !!**

CARBURETOR

Manufacturer
LEADER or MIKUNI

SPARK PLUG

Manufacturer/model
NGK/ BR8HSA
Spark plug gap
0.6-0.7 mm

CLUTCH

Clutch type
Dry, centrifugal automatic
Transmission type
V-belt automatic

CHASSIS

Frame type
Steel tube backbone

FRONT TIRE

Rim: E12X 3.5
Tyre: 120/70-12

REAR TIRE

Rim: E12X 3.5
Tyre: 130/70-12

SPECIFICATIONS

TIRE AIR PRESSURE (COLD TIRES)

Front: 2.1 bar - 2.5 bar

Rear: 2.1 bar - 2.5 bar

The selected tire pressure depends on the load!

FRONT BRAKE

Type

Single Hydraulic disc brake

190mm

Operation

Right hand

RECOMMENDED FLUID

DOT 4 - CASTROL Super Disc

Bremsflüssigkeit DOT 4

REAR BRAKE

Type

Mechanical Drum brake 110 mm

Operation

Left hand

FRONT SUSPENSION

Type

Telescopic fork

Spring/shock absorber type

Coil spring/oil damper

REAR SUSPENSION

Type

Unit swing

Spring/shock absorber type

Coil spring/oil damper

ELECTRICAL SYSTEM

Ignition system

CDI

Charging system

CDI magneto

BATTERY

Model

YTX4L-BS

Voltage, capacity

12 V, 4.0 Ah

HEADLIGHT

Halogen bulb

BULB VOLTAGE, WATTAGE X QUANTITY

Headlight

12 V, 35 W/35.0 W

Tail/brake light

12 V, 5,0 W/21.0 W

Front turn signal light

12 V, 10.0 W

Rear turn signal light

12 V, 10.0 W

License plate light

12 V, 5.0 W

Meter lighting

12 V, 2 W

Meter lighting (fuel meter)

12 V, 2 W

High beam indicator light

12 V, 2 W

Oil level warning light

12 V, 3 W

Turn signal indicator light

12 V, 3 W

FUSES

Main fuse

10.0 A

CONSUMER INFORMATION

IDENTIFICATION NUMBERS (VIN)

Please write down the VIN (vehicle identification number) to order replacement parts from your dealer or the vehicle should be stolen.

The chassis number is stamped into the frame. To see this, take the cover (1) from the inner lining in the foot.

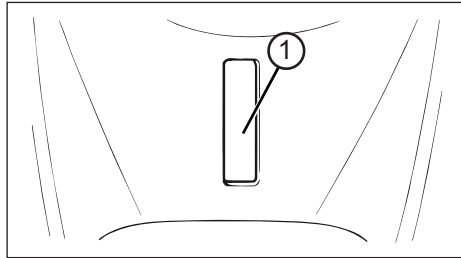

CAUTION

The vehicle identification number is used to identify your motorcycle and may be used to register your vehicle with the licensing authority in your area.

WARRANTY INFORMATION

Please carefully read the instruction manual of your vehicle before operating it in order to make yourself familiar with its handling. We explicitly point out that the instruction, maintenance, and care instructions given in the operating manual have to be complied with in order to sustain your claim towards warranty. Only the strict compliance with customer specifications stated in the instruction manual ensures the prolonging of the natural life of your vehicle. Starting with the date of the invoice a limited warranty of 24 months is granted regarding the accuracy of the vehicle in terms of material and manufacturing according to latest standards. The legal warranty regulations will not be restricted by this limited guarantee. Maintenance work has to be exclusively done by authorized workshops entitled by us. Warranty in general is bound to the region of invoicing and can therefore only be carried out within the country the vehicle was bought. Damages that can be traced back to inappropriate usage, manipulation, or neglecting of the maintenance/care/operating instructions will not be covered by warranty. Warranty can only be granted if occurring damages are immediately being reported to the seller or any other authorized workshop by the buyer. The warranty claim entitles the buyer to remedy deficiencies or to the reparation respectively the exchange of a damaged part in an authorized workshop after our approval. Compensation for remote or instantaneous damages cannot be granted. Vehicles in desolate condition will not be covered by warranty. Repair works carried out on warranty do not enlarge the guarantee period. Only this document entitles you to call on warranty services. Therefore please make sure that you are delivered this fully filled in document by the seller and that he has registered your vehicle correctly in our system. Please also mind the following advices.

Body and panelling of the vehicle have to be kept free of dirt constantly. Do not use high pressure water blasters, strong jets of water, sharp and corrosive or other aggressive detergents which could harm surfaces and varnish permanently and foster corrosion. It is vital to use protecting cleansers. Please consult our dealers for the right and appropriate products. Aluminium parts or other refined parts (chrome parts, anodized parts or other processed surfaces) have to be treated with appropriate maintenance products in order to prevent oxidation. Frame and metal parts are continuously to be treated with anticorrosive. A vehicle constantly parked outside has to be covered to avoid weathering and crack formations on seat and plastic parts. Vehicles used off-road and for racing purposes are excluded from warranty.

Material which is to be used in the context of service and maintenance works are excluded from warranty as well as the following parts: incandescent bulbs, brake pads, clutch lining, filter elements, spark plugs, drive sprocket, wheel and axle., as well as the tires.

MAINTENANCE SCHEDULE

The guarantee can be granted only if the vehicle has been serviced in accordance with this maintenance schedule.

The inspection intervals are required, otherwise, no guarantee can be granted.		1000 km or 1. month	4.000 km or 6. month	7.000 km or 12. month	10.000 km or 18. month	13.000 km or 24. month
PART	TO DO					
Air filter	Clean/ exchange	√	√	Exchange	√	√
Wheels, rims	Control	√	√	√	√	√
Tires	Control/ tire pressure		√	√	√	√
Wheel bearing	Control/ exchange		√	√	√	√
Steering bearing	Control/ clean/ lubricate	√	√	√	Lubricate	√
Screws Coverparts	Control/ tighten		√	√	√	√
Brake system	Control/ clean/ exchange		√	√	√	√
Main stand	Control/ clean/ lubricate		√	√	√	√
Front forke	Control		√	√	√	√
Rear suspension	Control		√	√	√	√
Oil pump	Control	√	√	√	√	√
Transmission oil	Exchange	Exchange		Exchange		Exchange
Variomatic belt	Control/ exchange		√	Exchange	√	
Fly wheels	Control/ exchange		√	Exchange	√	
Driven chain/ sproket	Control/ clean/ exchange					
Clutch	Control	√	√	√	√	√
Cable/ bowden	Control/ clean/ lubricate	√	√	√	√	√
Throttle	Control/ clean/ lubricate		√	√	√	√
Lights/ switches	Control/ adjust	√	√	√	√	√
Fuel line/ fuel filter	Control/ exchange			Exchange		
Idle speed	Control/ adjust	√	√	√	√	√
Exhaust system	Control/ tighten		√	√	√	√
Coolant	Control					

CAUTION: Variomatic belt, fly wheels, spark pluge, fuel filter and air filter element have to be exchanged every 7000km. Only use duration coolant. Brake lines have to be exchanged at least every 4 years. From 13.000km or 24th month the inspection should be made every 7000km. The vehicle is constantly checked for rust. The owner is responsible for rust prevention.

WIRING DIAGRAM

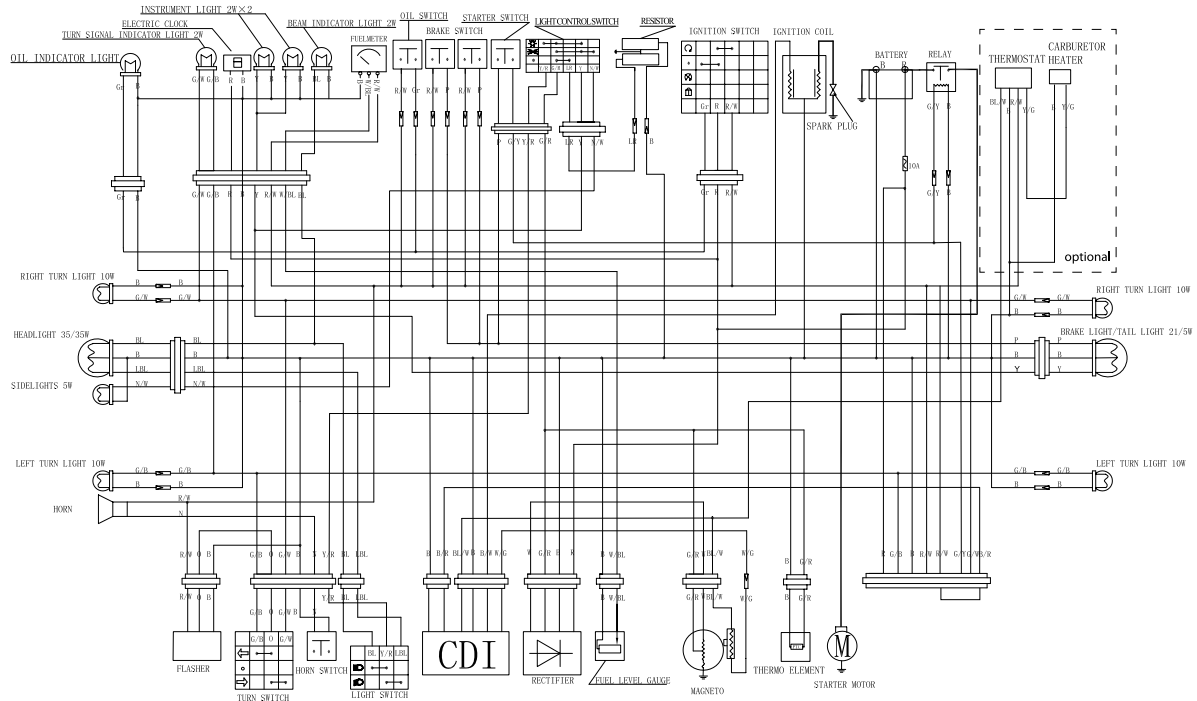

SYMBOL	B	R	W	BL	G	O	Y	P	N	LRL	Dg	G/Y	G/W	G/B	G/R	R/W	W/BL	R/W	N/W	Y/R	BL/W	LR
COLOR	BLACK	RED	WHITE	BLUE	GREEN	ORANGE	YELLOW	PURPLE	BROWN	LIGHT BLUE	DARK GREEN	GREEN/YELLOW	GREEN/WHITE	GREEN/BLACK	GREEN/RED	RED/WHITE	WHITE/BLUE	BLACK/WHITE	BROWN/WHITE	YELLOW/RED	BLUE/WHITE	PINK

SPACE FOR NOTES

