

## Multifuge<sup>®</sup> 1 S / 1 S-R

Instruction Manual



## How to use this manual

Use this manual to get acquainted with your centrifuge and its accessories.

This manual helps you to avoid inappropriate handling. Make sure to keep it close to the centrifuge.

**A manual that is not kept handy cannot provide protection against improper handling and thus against damage to persons and objects.**

The manual comprises chapters on

- Safety regulations
- Instrument description
- Transportation and hook-up
- Rotor program and accessories
- Use of the centrifuge
- Maintenance and care
- Troubleshooting
- Technical data
- Index

Overleaf you will find a graphic representation of the control panel with a survey of the most important functions

# Please fold out

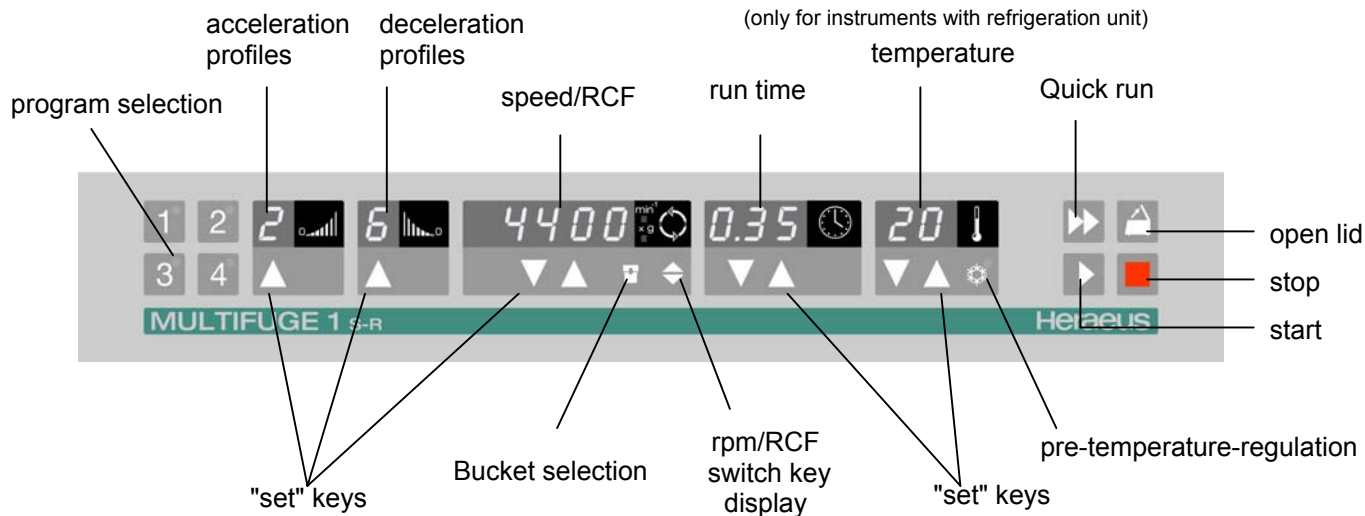

 Before switching on the centrifuge please read this manual

The **mains switch** is located on the right-hand side panel.

Pressed up = ON I  
 Pressed down = OFF 0

# Control panel of the Multifuge® 1 S / 1 S-R

## Display panels

### Program selection

key 1 - 4 : store or recall programs.

**acceleration profiles** (1= slowest ..... 9= fastest)

permanent display: acceleration profile last set 1- 9

**Deceleration profiles** (1= slowest ..... 9= fastest)

permanent display: deceleration profile last set 1- 9

### Speed / RCF

run: current value of speed or RCF after activation of switch key

end: "End"

lid open: "OPEN"

"Lift Lid" (if lid is not automatically lifted off)

(before start)

lid closed: "0" with flashing point  
(rotor not yet identified)

error code: will flash in display

### Run time

time selection: - remaining run time to 0

continuous operation (hld):

- run time passed (in hours, minutes)

quick run: - run time passed (as long as button is held;  
in minutes and seconds)

### Temperature\*

run: current sample temperature in °C  
(in temperature equilibrium)

\* only for instruments with refrigeration unit

## Keys

start :	normal start of the centrifuge
stop :	manual stop of a run
open lid:	open lid (possible only with the instrument switched on)
quick run:	short-term operation of the centrifuge as long as key remains pressed
rpm/RCF switch:	switching between rpm and RCF display
bucket set.:	Setting of the bucket number
pretemp :	Pre-temp-function*
"set" keys:	stepwise increase/decrease of setpoint values

Short pressing of any of the "set" keys: switch from current to preset value, signaled by flashing display.

Error codes (troubleshooting see chapter "Troubleshooting"):

E-19: Unpermissible rotor

E-20: Rotor not identified

E-29: Motor or rotor blocked

E-31: Overtemperature in motor

E-32: Overtemperature in electronic

E-33: Excessive pressure in the refrigeration unit

E-34: Overvoltage

E-35: Overcurrent

Lift Lid : Smoothly lift the lid

rotor: set speed higher than permissible speed of the rotor

bAL : imbalance

**Contents**

**For your safety..... 3**  
Proper use..... 3  
Improper use..... 3  
Centrifuging hazardous materials..... 3  
Handling the centrifuge..... 4  
Conformity to current standards..... 5  
Safety instructions in this manual..... 5

**The Multifuge® 1 S / 1 S-R..... 7**  
Description..... 7  
Safety systems..... 8  
Parts supplied..... 8  
Function and features..... 9

**Before use..... 13**  
Centrifuge transport and installation..... 13  
Proper location..... 13  
Main connection..... 14

**Rotors and accessories..... 15**  
Rotors for the Multifuge® 1 S..... 16  
Rotors for the *Multifuge® 1 S-R*..... 20  
Handling the rotor..... 29  
    Aerosol-tight operation..... 32  
    Checking of aerosol-tight bio-containment..... 36

**Operation..... 37**  
Switching on the centrifuge..... 37  
Actuating the lid..... 37  
    Opening the lid..... 37  
    Closing the lid..... 37  
Installing the rotor..... 38  
Loading the rotor..... 39  
    Maximum loading..... 39  
    Filling the centrifuge tubes..... 40  
    Maximum permissible load difference..... 40  
    Inserting the centrifuge tubes..... 41  
Entering parameters..... 43  
Deceleration curves..... 43  
Switching from speed to RCF display..... 43  
Bucket selection for swinging bucket rotors..... 43  
Selecting speed..... 44  
Entering the RCF value..... 44  
    More about the RCF value..... 45  
Selecting run time..... 45  
    Run time selection..... 45  
    Continuous operation..... 46  
    Extended time mode..... 46  
Selecting the temperature..... 47  
Pretemp function..... 47  
Starting the centrifuge..... 48

Imbalance display.....	48	<b>Troubleshooting .....</b>	<b>59</b>
Changing the settings during the run .....	48	Emergency lid release.....	59
Stopping the centrifuge .....	49	Error troubleshooting.....	61
Stopping with preset run time .....	49	Contacting Kendro Service.....	70
Stopping with continuous operation .....	49	<b>Technical Data .....</b>	<b>71</b>
Temperature control during standby .....	49	Electrical connections / fuses .....	73
Working with programs.....	50	<b>Appendix .....</b>	<b>75</b>
Program display.....	50	Acceleration and deceleration profiles .....	75
Entering/changing a program .....	50	Speed/RCF diagrams.....	87
Centrifuging with a program .....	50	<b>Index .....</b>	<b>93</b>
"Quick Run" .....	51		
Removing the rotor.....	51		
Audible alarm .....	52		
Turning off the centrifuge .....	52		
<b>Maintenance and care .....</b>	<b>53</b>		
Maintenance to be performed by the customer .....	53		
Cleaning.....	53		
Disinfection .....	54		
Decontamination.....	56		
Autoclaving .....	56		
The KENDRO service offer .....	57		
Warranty conditions.....	57		

## For your safety

Heraeus centrifuges are manufactured according to current technical standards and regulations. Nonetheless, centrifuges may pose danger to individuals and surrounding if

- they are not used as designed
- they are operated by untrained personnel
- their design is improperly changed
- the safety instructions are not followed

**Therefore, personnel involved with operation and maintenance of the centrifuge must read and follow the safety instructions.**

In addition, the pertinent regulations for prevention of accidents must be strictly followed.



This manual is an integral part of the centrifuge assembly and must be kept close at hand at all times.



**When damages to the power cord or at casing are noticed the centrifuge must to be set out of operation!**

## Proper use

The centrifuge is designed to separate liquid-suspended materials having different densities and particle size, respectively (maximum sample density is 1.2 g/cm<sup>3</sup> {ml} at maximum speed).

## Improper use

During a run, a safety zone of 30 cm around the centrifuge must be maintained where neither persons nor hazardous materials may be present.

The centrifuge may cause harm to its user or other persons or may damage goods if safety measures are not followed:

## Centrifuging hazardous materials

- The centrifuge is neither made inert, nor is it explosion-proof. Therefore never use the centrifuge in an explosion-prone environment.
- Do not centrifuge explosive or flammable substances. The same holds for substances prone to react violently with each other.

- Do not centrifuge toxic or radioactive substances or pathogenic microorganisms without suitable safety systems.

If microbiological samples of risk group II (according to "Laboratory Bio-safety Manual" of WHO) are being centrifuged, aerosol-tight bio-seals have to be used.

For materials in a higher risk group, more than one precaution is required.

- Should toxins or pathogenic substances enter the centrifuge or its parts, you must perform appropriate procedures for disinfection (see "Maintenance and care – Disinfection").
- Strongly corrosive substances that may cause damage to materials and reduce the mechanical strength of the rotor may be centrifuged only inside protective tubes.

### Handling the centrifuge

- Use only original accessories for the centrifuge. The only exceptions are common glass or plastic centrifuge tubes if they are approved for the rotor speed and RCF values.
- Never use the centrifuge unless the rotor is properly installed.

- You may use the centrifuge only with a properly loaded rotor. You must not overload the rotor.
- Strictly follow the rules and regulations for cleaning and disinfection
- If the rotor or the rotor lid shows signs of corrosion or wear, you must stop using it.
- Never open the lid manually if the rotor is still turning.
- You may use the emergency lid release only in case of emergency, e.g. during an interruption of power supply (see chapter "Troubleshooting").
- Never use the centrifuge with an opened lid.
- Never use the centrifuge if the front panel has been partially or totally removed.
- Changes in mechanical or electrical components of the centrifuge may only be carried out by individuals authorized by Kendro Laboratory Products.



## Conformity to current standards

Heraeus centrifuges are manufactured and tested according to the following standards and regulations:

- For all voltages

- **IEC 61010**

- For 120 V only



- For 230 V only



Please get acquainted with the details of the test standards from the technical data.

## Safety instructions in this manual



This symbol denotes potential hazards to persons.



This symbol denotes potential damage to the centrifuge or parts in its immediate surroundings.



General comments are marked with this symbol.

In addition, you are asked to adhere to the pertinent regulations, in Germany

- Regulations for prevention of accidents BGV A2
- Regulations for prevention of accidents VBG 5
- Regulations for prevention of accidents VBG 7z
  - with cooled devices additionally
- Regulations for prevention of accidents BGV D4

For your safety

---

Notes

## The Multifuge<sup>®</sup> 1 S / 1 S-R

The figure below shows a *Multifuge*<sup>®</sup> 1 S-R with an opened lid and a swinging bucket rotor installed.



## Description

The *Multifuge*<sup>®</sup> 1 S-R is a general-purpose tabletop centrifuge for biotechnological and pharmaceutical research that moves high capacity centrifugation onto the fast track. It spins more tubes at higher RCFs more rapidly than competitive instruments and can process nominally 1.6 liters of sample in a single run. There are various rotors available that can achieve high RCFs and accommodate a wide range of accessories for all common tube types, micro titer and deep well plates.

The user-friendly "EASYset" control panel permits easy selection of speed, RCF value, run time and run profile (acceleration and deceleration), as well as temperature of the *Multifuge*<sup>®</sup> 1 S-R. You can switch from speed to RCF display and vice versa, with a touch of a button and even during a run.

## Safety systems

The *Multifuge*® is equipped with a number of safety systems:

- Housing and lid are constructed of 6 mm steel.
- Lid with window
- Lid lock with safety check

You can only open the centrifuge lid when the power is turned on and the rotor has come to a stop. You can only start the centrifuge if the lid is properly locked.

- Automatic rotor identification
- Electronic imbalance detection as a function of rotor (SMARTspin™)



**Do not tamper with the safety systems!**

## Parts supplied

Accessories supplied with the centrifuge are:

- power cord
- a special wrench for securing the rotor  
(As seen in the picture)
- condensed operating instructions
- corrosion protective oil



The printed documents consist of the delivery notes and this Manual.

## Function and features





Basic unit/ function	Description / feature
Cabinet / frame	Galvanized steel
Chamber	Stainless steel * (Multifuge 1S: coated steel)
Drive	Brushless induction drive
Key pad and display	Key pad and display elements covered by an easy-care continuous surface
Control	Microprocessor driven by "EASYset"
Main memory	Recalls last run parameters
Program memory	Data are stored until new values are entered.
Advanced features	RCF-programming, quick run, pre-temp *, temperature control during standby
Acceleration and deceleration profiles	9 acceleration and 9 deceleration profiles
Rotor identification	Automatic
SMARTspin <sup>™</sup> imbalance detection system	Electronic, effective as a function of rotor and speed
Soft touch lid lock	Motor assisted lid locking

(\* only with refrigeration unit)

## The EASYset user interface

Function	Feature
Program memory keys	Freely programmable
Acceleration / deceleration profile	1 = slowest, ... 9 = fastest acceleration / deceleration curve
Setting speed by rpm	Adjustable from 300 rpm to 15 000 rpm, in 10 rpm increments
RCF selection	Upon actuation of RCF switch , the RCF value can then be entered
Time selection	Adjustable in minutes from 1 min to 9 h 59 min, or extended time mode from 1 min to 99 h, "hld"-mode: continuous operation
Run time display in "quick run" mode	Between 1 s and 60 s in seconds´ steps, above in minutes´ steps
Setting temperature *	Adjustable from -9°C to +40°C, in one degree increments
End of centrifugation	The speed display will read "end"

(\* only with refrigeration unit)

Function	Feature
Lid opening	Automatic unlocking via "open lid" key (  ) (unlocking in case of power failure: see chapter "Troubleshooting")
Start	Start key (  )
Stop	Stop key (  )
"Quick Run" mode	Pressing the "quick run" key (  ) activates maximum acceleration up to the maximum permissible speed of rotor; upon key release the centrifuge stops with maximum deceleration power.
Diagnostic messages	<ul style="list-style-type: none"><li>• Alternating display "Rotor"/maximum speed or RCF (speed selected exceeds max. speed of the rotor)</li><li>• Lid has not been lifted off the lock during opening: display "lift lid" (manual lifting of lid is required)</li><li>• General instrument malfunction (error messages with ERROR codes, see "Troubleshooting")</li></ul>

Notes



## Before use

### Centrifuge transport and installation

After opening the box remove the protective materials.



When transporting the centrifuge, consider its weight (see "Technical Data"); always grab it on both sides ensuring that enough helpers are around.

**Do not lift on the front panel!**



The centrifuge can be damaged by jolting during the transport!

**Transport the centrifuge only in the upright position using proper containment and secure it properly. Handle the centrifuge carefully.**

### Proper location

The centrifuge may only be used indoors. Its location must meet the following criteria:

- A safety zone of at least 30 cm (12 inches) around the centrifuge must be maintained. Hazardous materials must not be stored beside the centrifuge during its use.
- The laboratory bench or centrifuge trolley must be stable and resonance-free. A good support is provided by a laboratory bench or a centrifuge cart with lockable casters.
- To ensure sufficient air circulation, a minimum distance from the wall of 10 cm (4 inches) at the back and of 15 cm (6 inches) on each side must be kept.

- The centrifuge must be protected from heat and direct sunlight.
- The location must be well ventilated at all times.



**UV rays reduce the durability of plastics.**

**Protect the centrifuge, rotors and plastic accessories from direct sunlight.**

## Main connection

Connect the centrifuge only to a grounded main power supply. Make sure that the power cord is compatible with the valid safety regulations and that your main voltage and frequency correspond to the specifications on the instrument label.

Make sure that the centrifuge is switched off (on the right-hand side of front panel) before connecting electrical wire to main power supply.

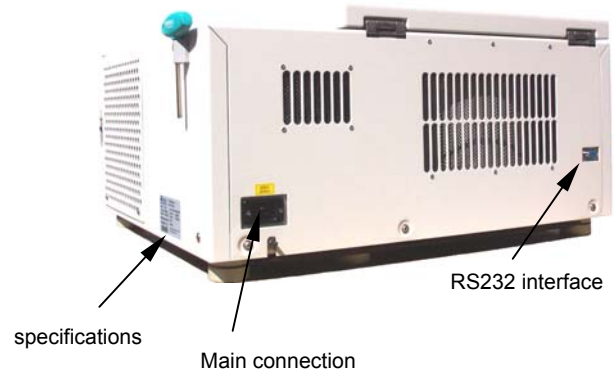

## Rotors and accessories

A rotor is not included as part of a *Multifuge*<sup>®</sup> centrifuge.

A large variety of rotors are available as accessories. In addition, there are adapters and reduction sleeves for a variety of commercially available tubes and bottles.

For a complete list of available tubes, bottles, adapters and accessories, please refer to our current sales documentation.

For more information you can visit our web site at <http://www.Kendro.com>



### **Multifuge<sup>®</sup> 1 S (air cooled)**

During centrifugation, heat is generated by air friction between the rapidly spinning rotor and the air inside the rotor chamber. The continuous air flow in the air cooled centrifuge is restricting the temperature rise of the samples. The equilibrium temperature rise depends on the ambient temperature, the type of rotor, the speed, the duration and the number of runs.



**Use caution when touching rotors as they may be hot after long runs at high speed.**

**Rotors for the Multifuge® 1 S**

<i>Table 1: Rotors for Multifuge® 1 S</i>		Differences of 120V instruments are shown in parentheses	
Rotor designation	<b>Swinging Bucket Rotor TTH 400 75002000</b>		
With bucket	<b>Rectangular bucket 150 ml 75002001</b>		<b>Round bucket 400 ml 75002002</b>
Order no.			
Maximum permissible load [ g ]	4 x 540		4 x 570
Maximum speed $n_{\max}$ [ rpm ]	4700 ( 4500 )		4700
Maximum RCF value at $n_{\max}$	4618 ( 4234 )		4618
Radius (max.) [ cm ]	18.7		18.7
Acceleration / deceleration time [ s ]	40 / 35 ( 50 / 40 )		40 / 35 ( 55 / 40 )
Heating of samples at $n_{\max}$ [ °C ] relative to room temperature 23°C, run time 1 hour	12.0 ( 14.0 )		13.0
Aerosol-tight *	Yes (with cap 75002003)		Yes (with cap 75002004)
Autoclavable	121°C		121°C

\* Tested and approved by CAMR, Porton-Down, UK

<i>Table 1: Rotors for Multifuge® 1 S</i>		Differences of 120V instruments are shown in parentheses	
Rotor designation	<b>Swinging Bucket Rotor TTH 400 75002000</b>		
With bucket Order no.	<b>Multiple carriers 14 x 15 ml 75002027</b>	<b>Multiple carriers 5 x 50 ml + 2 x 15 ml 75002028</b>	
Maximum permissible load [ g ]	4 x 420	4 x 430	
Maximum speed $n_{\max}$ [ rpm ]	4700 ( 4500 )	4700 ( 4500 )	
Maximum RCF value at $n_{\max}$	4642 ( 4256 )	4593 ( 4210 )	
Radius (max.) [ cm ]	18.8	18.6	
Acceleration / deceleration time [ s ]	40 / 35 ( 65 / 40 )	40 / 35 ( 65 / 40 )	
Heating of samples at $n_{\max}$ [ °C ] relative to room temperature 23°C, run time 1 hour	15.0 ( 13.0 )	15.0 ( 13.0 )	
Aerosol-tight	—	—	
Autoclavable	121°C	121°C	

<i>Table 1: Rotors for Multifuge® 1 S</i>		Differences of 120V instruments are shown in parentheses	
Rotor designation Order no.	<b>BIOshield® 600 Rotor</b> <b>4 x 150 ml</b> <b>75002005</b>	<b>Micro plate carrier</b> <b>MP 3300</b> <b>75002010</b>	
Maximum permissible load [ g ]	4 x 540	2 x 600	
Maximum speed $n_{max}$ [ rpm ]	5700	4400	
Maximum RCF value at $n_{max}$	6175	3355	
Radius (max.) [ cm ]	17.0	15,5	
Acceleration / deceleration time [ s ]	55 / 55 ( 80 / 50 )	35 / 35 ( 40 / 35 )	
Heating of samples at $n_{max}$ [ °C ] relative to room temperature 23°C, Run time 1 hour	11.0	8.0	
Aerosol-tight *	Yes	Yes (with cap 75002011)	
Autoclavable	121°C	121°C	

\* Tested and approved by CAMR, Porton-Down, UK

<i>Table 1: Rotors for Multifuge® 1 S</i>		
Differences of 120V instruments are shown in parentheses		
Rotor designation Order no.	<b>Fixed-Angle Rotor FA12.94 Highconic®</b> 6 x 94 ml / 12 x 16 ml 75002006	<b>Micro Liter Rotor</b> 48 x 2 ml 75003348
Maximum permissible load [ g ]	6 x 140 / 12 x 30	48 x 4
Maximum speed $n_{max}$ [ rpm ]	10 150	15 000
Maximum RCF value at $n_{max}$	14 513	24 652 - outer ring 21 885 - inner ring
Radius (max. / min.) [ cm ]	12.5 / 6.1	9.8 / 5.9
Tube angle [ ° ]	45	45
Acceleration / deceleration time [ s ]	40 / 50 ( 60 / 45 )	35 / 30 ( 40 / 35 )
Heating of samples [ °C / at rpm / run time ] relative to room temperature 23°C	9.0 °C / 10 150 / 1 h	15.0 °C / 12 000 / 1 h 15.0 °C / 15 000 / 15 min 23.0 °C / 15 000 / 1 h
Aerosol-tight *	Yes	Yes
Autoclavable	121°	138°

\* Tested and approved by CAMR, Porton-Down, UK

## Rotors for the *Multifuge*<sup>®</sup> 1 S-R

<i>Table 2: Rotors for Multifuge</i> <sup>®</sup> 1 S-R		Differences of 120V instruments are shown in parentheses	
Rotor designation	<b>Swinging Bucket Rotor TTH 400 75002000</b>		
With bucket	<b>Rectangular bucket 150 ml 75002001</b>	<b>Round bucket 400 ml 75002002</b>	
Order no.			
Maximum permissible load [ g ]	4 x 540	4 x 570	
Maximum speed $n_{\max}$ [ rpm ]	4700 ( 4600 )	4700	
Maximum RCF value at $n_{\max}$	4618 ( 4424 )	4618	
Radius (max.) [ cm ]	18.7	18.7	
Acceleration / deceleration time [ s ]	35 / 35 ( 45 / 40 )	35 / 35 ( 45 / 40 )	
Min temperature at $n_{\max}$ [ °C ] relative to room temperature 23°C	10 ( 12 )	4 ( 7 )	
Speed at 4°C [ rpm ]	4300 ( 4100 )	4700 ( 4450 )	
Aerosol-tight *	Yes (with cap 75002003)	Yes (with cap 75002004)	
Autoclavable	121°C	121°C	

\* Tested and approved by CAMR, Porton-Down, UK



<i>Table 2: Rotors for Multifuge® 1 S-R</i>		Differences of 120V instruments are shown in parentheses	
Rotor designation	<b>Swinging Bucket Rotor TTH 400 75002000</b>		
With bucket Order no.	<b>Multiple carriers 14 x 15 ml 75002027</b>	<b>Multiple carriers 5 x 50 ml + 2 x 15 ml 75002028</b>	
Maximum permissible load [ g ]	4 x 420	4 x 430	
Maximum speed $n_{max}$ [ rpm ]	4700 ( 4500 )	4700 ( 4500 )	
Maximum RCF value at $n_{max}$	4642 ( 4256 )	4593 ( 4210 )	
Radius (max.) [ cm ]	18.8	18.6	
Acceleration / deceleration time [ s ]	40 / 35 ( 65 / 40 )	40 / 35 ( 65 / 40 )	
Heating of samples at $n_{max}$ [ °C ] relative to room temperature 23°C, run time 1 hour	15.0 ( 13.0 )	15.0 ( 13.0 )	
Aerosol-tight	—	—	
Autoclavable	121°C	121°C	

<i>Table 2: Rotors for Multifuge® 1 S-R</i>		Differences of 120V instruments are shown in parentheses	
Rotor designation	<b>BIOshield® 600 Rotor</b>	<b>Micro plate carrier</b>	
Order no.	<b>4 x 150 ml</b> <b>75002005</b>	<b>MP 3300</b> <b>75002010</b>	
Maximum permissible load [ g ]	4 x 540	2 x 600	
Maximum speed $n_{max}$ [ rpm ]	6000	4400	
Maximum RCF value at $n_{max}$	6842	3355	
Radius (max.) [ cm ]	17,0	15,5	
Acceleration / deceleration time [ s ]	50 / 50 ( 70 / 55 )	35 / 40 ( 40 / 40 )	
Min temperature at $n_{max}$ [ °C ] relative to room temperature 23°C	5 ( 8 )	< 0	
Speed at 4°C [ rpm ]	5900 ( 5700 )	4400	
Aerosol-tight *	Yes	Yes (with cap 75002011)	
Autoclavable	121°C	121°C	

\* Tested and approved by CAMR, Porton-Down, UK

<i>Table 2: Rotors for Multifuge® 1 S-R</i>		Differences of 120V instruments are shown in parentheses	
Rotor designation Order no.	<b>Fixed-Angle Rotor FA12.94 Highconic®</b> <b>6 x 94 ml / 12 x 16 ml</b> <b>75002006</b>	<b>Micro Liter Rotor</b> <b>48 x 2.0 ml</b> <b>75003348</b>	
Maximum permissible load [ g ]	6 x 140 / 12 x 30	48 x 4	
Maximum speed $n_{max}$ [ rpm ]	10 350	15 000	
Maximum RCF value at $n_{max}$	15 090	24 652	- outer ring
		21 885	- inner ring
Radius (max./min.) [ cm ]	12.5 / 6.1	9.8 / 5.9	
Tube angle [ ° ]	45	45	
Acceleration / deceleration time [ s ]	45 / 45 ( 55 / 50 )	30 / 30	( 40 / 30 )
Min temperature at $n_{max}$ [ °C ] relative to room temperature 23°C	0 ( 4 )	4	( 6 )
Speed at 4°C [ rpm ]	10 350	15 000	( 14 500 )
Aerosol-tight *	Yes	Yes	
Autoclavable	121°C	138°C	

\* Tested and approved by CAMR, Porton-Down, UK

## Adapter

<i>Table 3: Adapter (1)</i> * Max. tube length with aerosol-tight cap					
<b>Adapter and accessories for rectangular buckets 7500 2001</b>	Max. tube dimensions d <sup>1)</sup> x length/ * [mm]	Cap diameter [ mm ]	Tubes per rotor	Color	Order no.
<b>Centri-Lab® Adapter type A plus</b>					
14 x 7 ml blood sampling	13.0 x 117	16.5	56	grey	7500 2022
12 x 15 ml blood sampling	17.0 x 117	19.5	48	white	7500 2021
8 x 15 ml conical	17.0 x 120	22.0	32	brown	7500 2020
<b>Centri-Lab® Adapter type A</b>					
40 x 1.5 / 2 ml micro liter tube	11.0 x 45	-	160	black	7500 5335
20 x 7 ml DIN	13.0 x 115	13.0	80	yellow	7500 5321
12 x 15 ml DIN	17.0 x 115	18.3	48	red	7500 5322
4 x 25 ml universal container	22.5 x 100	31.0	16	green	7500 5391
5 x 25 ml DIN	25.0 x 115	25.9	20	orange	7500 5323
2 x 50 ml DIN	34.0 x 120	35.6	8	green	7500 5324
2 x 50 ml conical	29.5 x 120	37.5	8	green-yellow	7500 5386
1 x 50 ml oil test	-	-	4	nature	7500 5339
1 x 100 ml DIN	44.0 x 120	48.1	4	blue	7500 5325
1 x 150 ml DIN	50.0 x 110	-	4	grey-blue	7500 5326
for cyto-system	-	-	-	-	7600 3417
<b>Aerosol-tight caps</b>	2 pieces, incl. seals and lubricants				<b>7500 2003</b>
<b>Spar seal</b>	4 pieces, incl. lubricants				<b>7500 2008</b>

<sup>1)</sup> d = diameter

<i>Table 3: Adapter (2)</i>		* Max. tube length with aerosol-tight cap			
<b>Adapter and accessories for round buckets 7500 2002</b>	Max. tube dimensions d <sup>1)</sup> x length / * [mm]	Cap diameter [mm]	Tubes per rotor	Color	No. of order
<b>Centri-Lab<sup>®</sup> Adapter type E</b>					
34 x 1.5 / 2 ml micro liter tube	10.5 x 46	14.0	136	black	7500 7578
18 x 7 ml DIN	13.0 x 123	14.0	72	yellow	7500 7571
10 x 7 ml blood sampling	13.0 x 123	18.4	40	grey	7500 7579
10 x 15 ml DIN	17.2 x 122	18.4	40	red	7500 7572
8 x 15 ml conical	17.0 x 127	23.0	32	brown	7500 7621
5 x 25 ml US-urine	16.5 x 123	27.5	20	orange-red	7500 7581
5 x 25 ml DIN	25.5 x 121	29.0	20	orange	7500 7573
3 x 50 ml universal container	25.0 x 120	32.0	12	green-yellow	7500 7580
3 x 50 ml conical	29.0 x 119	37.5	12	green-yellow	7500 7577
3 x 50 ml DIN	34.5 x 120	36.0	12	green	7500 7574
1 x 100 ml DIN	45.0 x 134	59.0	4	blue	7500 7575
1 x 250 ml bottle	62.0 x 135	-	4	nature	7500 7622
<b>400 ml bottle</b>	80.0 x 135	-	4	nature	7500 7583
<b>Aerosol-tight caps</b>	2 pieces, incl. seals and lubricants				<b>7500 2004</b>
<b>Spar seal</b>	4 pieces, incl. lubricants				<b>7500 2009</b>

<sup>1)</sup> d = diameter

<i>Table 3: Adapter (3)</i> * max. tube length with aerosol-tight cap					
<b>Adapter and accessories for BIOshield® 600 Rotor 7500 2005</b>	Max. tube dimensions d <sup>1)</sup> x length / * [mm]	Cap diameter [ mm ]	Tubes per rotor	Color	No. of order
<b>Centri-Lab® Adapter type A</b>					
40 x 1.5 / 2 ml micro liter tube	11.0 x 45	-	160	black	7500 5335
20 x 7 ml DIN	13.0 x 115	13.0	80	yellow	7500 5321
12 x 7 ml blood sampling	13.0 x 117	16.5	48	grey	7500 5330
11 x 15 ml blood sampling	17.0 x 117	19.5	44	white	7500 5327
6 x 15 ml conical	17.0 x 120	22.0	24	brown	7500 5387
12 x 15 ml DIN	17.0 x 115	18.3	48	red	7500 5322
4 x 25 ml universal container	22.5 x 100	31.0	16	green	7500 5391
5 x 25 ml DIN	25.0 x 115	25.9	20	orange	7500 5323
2 x 50 ml DIN	34.0 x 120	35.6	8	green	7500 5324
2 x 50 ml conical	29.5 x 120	37.5	8	green-yellow	7500 5386
1 x 50 ml oil test	-	-	4	nature	7500 5339
1 x 100 ml DIN	44.0 x 120	48.1	4	blue	7500 5325
1 x 150 ml DIN	50.0 x 110	-	4	black	7500 5326
for cyto-system	-	-	-	-	7600 3417
<b>Spar seal</b>	1 set, incl. lubricants				<b>7500 2007</b>

<sup>1)</sup> d = diameter

<i>Table 3: Adapter (4)</i>					
<b>Adapter and accessories for Fixed-Angle Rotor FA12.94 7500 2006</b>	Max. tube dimensions d <sup>1)</sup> x length [mm]	Number per adapter	Number per rotor	Color	No. of order
<b>Adapter for 94 ml cavity</b>					
1.5 ml micro tube	11 x 58	4	24	nature	7600 2905
3.5 ml	11 x 103	4	24	nature	7500 3091
6.5 ml	13 x 115	2	12	nature	7500 3092
12 ml	16 x 96	2	12	nature	7500 3093
16 ml *	18 x 124	1	6	nature	7600 2906
38 ml	25 x 112	1	6	nature	7500 3094
50 ml	29 x 118	1	6	blue	7500 3102
15 ml conical	16.5 x 120	1	6	nature	7500 3095
50 ml conical	30 x 117	1	6	green	7500 3103
<b>Spare seal</b>	2 sets, incl. lubricants				<b>7500 3058</b>
<b>Adapter for 16 ml cavity</b>					
for 10 ml Vacutainer	Reducer insert (16 x 100 mm)				7500 3763
for 7 ml Vacutainer *	Reducer insert (13 x 100 mm)				7600 3225
for 5 ml Vacutainer	Reducer insert (13 x 75 mm)				7600 3226

<sup>1)</sup> d = diameter

\* For 7 ml Vacutainer, Adapter 7600 2906 and 7600 3225 required.

<i>Tabelle 3: Adapter (5)</i>		
<b>Accessories for Micro plate carrier MP 3300 7500 2010</b>		No. of order
<b>Aerosol-tight cap</b>	2 pieces, incl. seals and lubricants	<b>7500 2011</b>
<b>Adapter for micro plate carrier</b>		<b>7500 2013</b>
<b>Spare seal</b>	2 pieces, incl. lubricants	<b>7500 2012</b>

<i>Table 3: Adapter (6)</i>					
<b>Adapter for Micro Liter Rotor 7500 3348</b>	Max. tube dimensions d <sup>1)</sup> x length [ mm ]	Tube capacity [ ml ]	Number per set	Color	No. of order
Reduction sleeve PCR	6.2 x 20	0,2	24	Grey	7600 3750
Reduction sleeve	8 x 43.5	0.5 / 0,6	24	Turquoise	7600 3758
Reduction sleeve	6 x 46	0.25 / 0.4	24	Red	7600 3759

<sup>1)</sup> d = diameter



## Handling the rotor

**Swinging Bucket Rotor TTH 400  
BIOshield® 600 Rotor  
Micro plate carrier**



**All positions must always be loaded with identical carrier buckets!**

The various swinging buckets are split up into weight categories. These can be identified through the letters suffixing the order number on the bucket. Buckets of identical weight categories should always be installed in opposing rotor positions to avoid imbalance.



**In case of repeat orders of buckets and carriers, please indicate the present weight category.**

The swinging bucket rotors have a slide coating which guarantees perfect operation without additional lubrication of body trunnion pins for many years.



Should an imbalanced run occur although the weight is correct, this could be due to wear of the slide coating.

In this case the rotor function remains intact through normal lubrication: at regular intervals, apply a light coating of lubricant to the rotor body trunnion pins and to the corresponding mating surfaces of the buckets!

**Lubricant 7000 6692 is supplied with the centrifuge.**

## BIOshield® 600 Rotor

7500 2005



**Do not run the rotor without the rotor cover installed.**

Store the BIOshield® Rotor with the cover removed after cleaning. This will enable the rotor to dry thoroughly.



Always maintain the rotor in the recommended manner.

The rotor and accessories must be cleaned and inspected regularly; do not use when showing signs of corrosion or cracking.



**Micro plate carrier MP 3300 7500 2010**

Remove the appropriate plate holder from the carrier body for loading and unloading of micro plates in the Micro plate carrier.



**The operation is permissible only with the associated carriers!**

**(Label "75002010")**



**Some commercially available micro-plates are not rated for the maximum achievable RCF of the Microplate carrier. Therefore please pay attention to the specifications of the plate manufacturer.**

Before loading, ensure that the rubber bottom is placed in the cut-outs of the bottom of the plate holder.

**The maximum loading height amounts to 55 mm!**



**Make sure the rotor is balanced!**

## Aerosol-tight operation



**Aerosol-tight rotors and tubes are only to be opened in an approved safety work bench when centrifuging dangerous samples!**

**It is necessary to pay attention to the maximum permissible filling quantities!**

Correct operation when filling the sample tubes and closing the rotor cover are prerequisites for aerosol bio-containment.



**Before use, the seals in the rotors and rotor covers as well as the aerosol-tight caps have to be checked for abrasion or damage and have to be slightly greased.**

**Replace damaged O-rings and seals!**



**Use the special lubricant 7600 3500 only to grease the seals!**

Spare parts are delivered with the rotor or may be ordered separately.



**Replace damaged or clouded caps and lids of rotors and tubes immediately.**

The tubes are only to be filled in such a way that the sample does not reach the rim of the tube during centrifuging.

## Closing the rectangular bucket 75002001 aerosol-tightly

After putting on the cap both levers are pressed down until they noticeably click in.

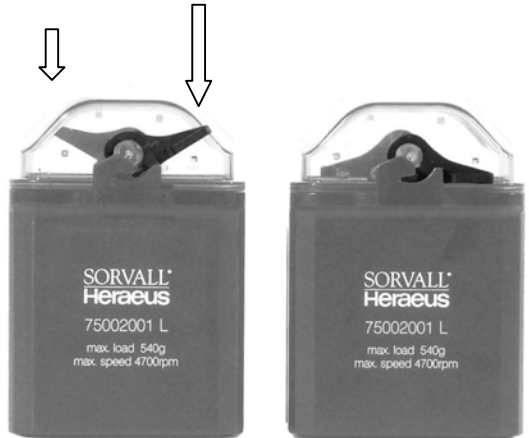

 **Both of the levers must click in order to achieve aerosol-tight bio-containment!**

## Closing the Micro test plates rotor MP3300 75002010 aerosol-tightly



Please flap both lock levers upward. The cap can now be easily put on the bucket. The bucket is locked through flapping down the levers.

 **Both of the levers must click in order to achieve aerosol-tight bio-containment!**



**Levers not being flapped down may cause damage to the caps during centrifugation!**

## Closing the round bucket 75002002 aerosol-tightly

After greasing the seal, turn the lid until it sits lightly on the bucket.

To achieve uniform seal, turn the lid tighter by 1 grip area (approx. 10°). Use the setting marks on the bucket as a guide.



## Closing Fixed-Angle Rotor aerosol-tightly

The hexagon wrench should be used as a support tool to fasten and loosen the lid of the fixed angle rotor in order to achieve secure closing (insert the hexagon wrench through the hole in the screw cap).



**Please pay attention to the maximum permissible filling volume during centrifugation of dangerous samples!**



Rotor	Vessel type / maximum filling volume			
Micro Liter Rotor 48 x 2.0 ml 75003348	Micro 1,5 ml <b>1,0 ml</b>	Micro 2,0 ml <b>1,5 ml</b>		
Fixed-Angle Rotor FA12.94 75002006	Falcon 50 ml <b>49 ml</b>	Falcon 15 ml <b>14 ml</b>		
	others: <b>- 2/3 nominal volume</b>			

- Micro – micro centrifuge tube
- Falcon – tube type Falcon

### Checking of aerosol-tight bio-containment

The checking of the rotor type and bucket was done according to the dynamic microbiological test procedure with regard to EN 61010-2-020 appendix AA.

The aerosol-tight bio-containment of the rotor mainly depends on proper handling!



**Check the aerosol-tight bio-containment of your rotor whenever necessary!**

- Shaking the bucket releases the carbon dioxide of the water, and an excessive pressure is built up.
- Leaks are recognized by humidity release and audible disinflation of gas mix.
- Finally buckets respectively rotor, lid and lid seal have to be dried.



It is very important that all the seals and seal-surfaces are carefully inspected for wear and damages like cracks, scratches and embrittlements!

For a quick test one can check the aerosol-tight buckets and fixed angle rotors according to the following procedure:

- Slightly grease all seals.
- Fill the bucket or rotor with approx. 50 ml carbon dioxide mineral water.
- Close the bucket or rotor according to the respective handling instructions.



## Operation

### Switching on the centrifuge

Locate the main power switch on the right-hand side of the front panel, and set it to the ON (I) position. For a couple of seconds the following reading appears in the control panel:



The display shows that the instrument is going through an internal check of its software.

(See table on page 70).

After this check, the display shows the actual value mode. The remaining run time and speed should both read 0. The display of the acceleration/deceleration curve depends on the last set value.

The following figure gives an example of possible readings. A detailed description of possible settings is given below in this chapter.



### Actuating the lid

#### Opening the lid

Press the "open lid" key .

If the message "Lift lid" appears, slightly lift the lid.

(Emergency release in case of malfunction or power failure: see chapter "Troubleshooting")

#### Closing the lid

The centrifuge lid is locked by slightly pressing down the front part of the lid. Locking is motor-driven.



**Do not slam the lid!**

## Installing the rotor



**Improper or improperly combined accessories may cause severe damage to the centrifuge!**

The rotors approved for the *Multifuge*® are detailed in the chapter "Rotors and accessories". Use only rotors listed for this instrument.

To install the rotor, you will need the wrench (see chapter "Parts supplied" – page 8).

Proceed as follows:

1. Open the lid and make sure that the rotor chamber is clean. Clean any dust, foreign material or sample residues out of the chamber before use.
2. Check if the collet chuck is loose (collet chuck moves freely on the spindle). If not, loosen the rotor seat using the supplied socket wrench.
3. Place the rotor on top of the collet chuck so that the rotor is located precisely above the center.

4. The rotor must glide freely down the collet chuck until it hits the lower stop.
5. If you have positioned the rotor correctly, you can tighten the collet chuck easily using the supplied hex wrench.
6. Place the rotor cover on applicable rotors and tighten it securely.



**Regularly check the proper positioning of the rotor and re-tighten the collet chuck as needed.**

Please take care of the legibility of the inscription of the installed swinging bucket rotor cross.

(Rotor identification must point to the chamber bottom)

For the swinging bucket rotor, the set bucket type must be permitted for the operation in the respective rotor. Please note the requirements of chapter "Bucket selection of swinging bucket rotors"

## Loading the rotor

### Maximum loading



**Overloading can result in destruction and severe damage to the centrifuge.**

The *Multifuge*<sup>®</sup> can reach high rotational speeds exerting enormous centrifugal force. The rotors are designed to warrant sufficient residual strength even at the highest permissible speed.

However, this safety system presupposes that the maximum permissible load of the rotor is not exceeded.



**Please get acquainted with the data about the maximum permissible loads and maximum speeds in chapter "Rotor and accessories".**

If you wish to centrifuge samples that, together with the adapters, exceed the maximum permissible load, you must either reduce the sample volume or calculate the permissible speed  $n_{perm}$  according to the following formula:

$$n_{perm} = n_{max} * \sqrt{\frac{\text{maximum permissible load}}{\text{actual load}}}$$

\*  $n_{perm}$  = permissible speed  
 $n_{max}$  = maximum speed

## Filling the centrifuge tubes



**Check carefully whether your tubes are approved for the respective RCF value. Follow tube manufacturer's recommendation.**

For common borosilicate glass tubes the maximum permissible rcf is limited to 4000 xg!

The tube manufacturers normally limit the respective maximum allowed RCF value to the fixed angle rotor.



Please note that for the same RCF value the stress for the tubes in a swinging-bucket rotor is higher!

Because of the higher difference of the radii ( $r_{\max} - r_{\min}$ ) the pressure of liquid column to the tube bottom is appreciably higher and strongly depended on filling.

Plastic tubes and bottles – especially for the highest load (speed, temperature) – have a limited life time and must be replaced as recommended by the manufacturer.

## Maximum permissible load difference



The smaller the imbalance of the centrifuge, the better the separation effect, because as imbalance is minimized, so is the resulting vibration, which could affect separation quality.

Therefore it is important that the tubes are properly balanced.

In case of exceeding the rotor specific imbalance values, the electronic imbalance shut-down is activated.

## Inserting the centrifuge tubes



The rotor must be loaded symmetrically. Failure to do so can cause rotor imbalance, which may lead to noisy operation, affect separation quality, or result in imbalance detection shutdown, as well as introduce significant detrimental wear to the motor and drive system.

When only partially loading the rotor, ensure that opposite bores receive tubes of equal weight (when centrifuging a single sample, place a centrifuge tube filled with water opposite of the sample).

After placing the tubes, install the rotor cover.

Fixed-angle rotors:

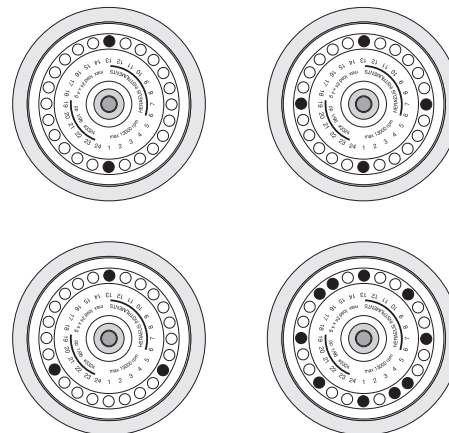

Proper loading

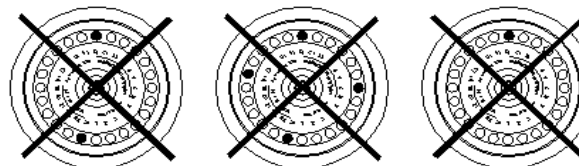

Improper loading

Swinging bucket rotors:

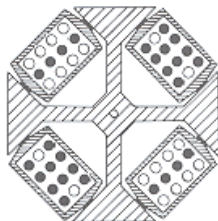
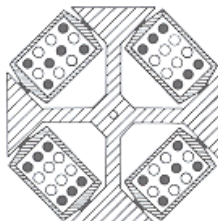
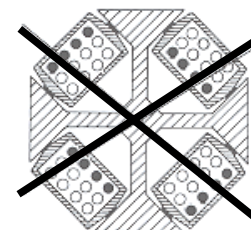
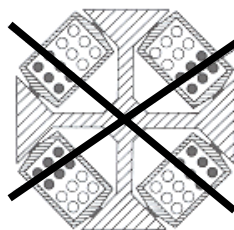
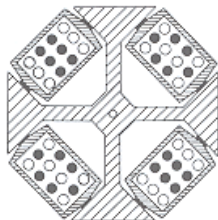
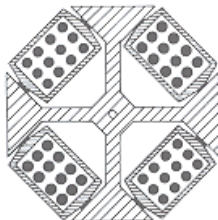

Improper loading



These examples are to be applied to the other rotors in an analogous manner!

Proper loading

## Entering parameters

### Deceleration curves

The *Multifuge*® offers 9 acceleration and deceleration profiles for optimal centrifuging of samples and gradients. Please consult the diagrams in the Appendix for more detail of the acceleration and deceleration curves (for rotors not mentioned here you may extrapolate the respective values).

After switching on the centrifuge, the centrifugation profiles last entered are selected.

By pressing the "set" key  you can scroll through the profile settings until the desired profile is reached.

Once the display stops flashing, the value is stored in memory and remains unchanged until changed by a new entry.

### Switching from speed to RCF display

Upon turning on the centrifuge, the speed display is set.

Use the speed mode selection key  to switch the speed entry and display between rpm and RCF.

### Bucket selection for swinging bucket rotors

When running a swinging bucket rotor, the automatic rotor identification feature will recognize the rotor body. Depending on the bucket or carrier installed on the rotor body the corresponding type of bucket or carrier must be selected on the bucket selection function. The bucket selection affects the correct RCF values display and the correct selection of the corresponding parameters of the temperature regulation.

The current part number of the buckets is displayed by pressing the bucket selection key (corresponds to the last four 4 digits of the order number).





To change the bucket selection, press the bucket selection key again until the correct set of buckets appears.

The value is accepted when the change back to the speed RCF display has occurred.

## Selecting speed

The centrifuge speed can be set to a minimum of 300 rpm and to a maximum of 15 000 rpm (depending on the rotor).

You can adjust the speed in 10 rpm increments. Proceed as follows:

1. By pressing the "set" keys  once (for an increase) or  (for a decrease) in the "speed" section of the control panel, you switch from actual to set point values. The value last stored is displayed, with the digit entered flashing (if there is no value stored in memory, this is indicated by dashes -----).



2. By briefly pressing the input key you can raise or lower the speed by one step (10 rpm) at a time.



3. If you hold down the pressed key, the display changes slowly at first and at an accelerated pace after a few seconds.
4. Release the key as soon as you have reached the desired value, and adjust if necessary by repeatedly pressing the key. The decimal place flashes for a

number of seconds, then changes to a permanent display. The speed is now stored.



For faster operation, you may shift the flashing cursor in the speed/RCF and the run time panels: just press both  and  simultaneously. The cursor moves by one digit to the left for each time the key is pressed.

## Entering the RCF value

You can adjust the RCF set point in steps of 1. The set point is entered analogously to the speed.

As long as the rotor has not been identified, it is not possible to display RCF values. This is signaled by dashes ----- in the display.

Shortly after starting the centrifuge run, the rotor is identified and the current value is displayed.

### NOTE:

If you set an extremely low RCF value, this may be automatically corrected if the resulting speed would be lower than 300 rpm.



### More about the RCF value

The relative centrifugal force (RCF) is given in multiples of the earth gravity  $g$ . It is a dimensionless number that allows comparing the efficiency of separation or sedimentation of diverse instruments since it is independent of the instrument used. The only values entered in the equation are radius and speed of centrifugation:

$$RCF = 11,18 * \left( \frac{n}{1000} \right)^2 * r$$

$r$  = radius of centrifugation in cm

$n$  = speed in rpm

The maximum RCF value refers to the maximum radius of the tube bore.



Please note that this value decreases depending on the tubes and adapters used.

You may take this into account when calculating the RCF value for your application.

### Selecting run time



There are two time modes: standard and extended.

In the standard time mode you can select a run time between 1 min and 9 h 59 min or continuous operation (hLd).

In the extended mode you can select a run time between 1 min and 99 h (from 10 h in one-hour steps), or continuous operation (hLd).

#### Run time selection

To set a time, proceed as follows:

1. Press one of the "set" keys  (for an increase) or  (for a decrease) in the "run time" section of the control panel once to switch from the actual to the set point mode.
2. By **briefly** pressing the "set" key you can now raise or lower the run time in 1-minute increments.



- 3 If you keep the selected key pressed, the display changes slowly at first and at an accelerated pace after a few seconds.
- 4 Release the key as soon as you have reached the desired value, and adjust if necessary by repeatedly pressing the key.

The minute display flashes for a number of seconds, then changes to permanent display. The run time is now stored.

You may shift the flashing cursor to set the value as described under "Selecting speed".

### Continuous operation

To switch the *Multifuge*<sup>®</sup> to the continuous mode, you must press the key  until the display reads "hLd") .





With this  setting, the centrifuge keeps running until stopped manually.

### Extended time mode

You have the option of switching to the extended time mode. To switch it on or off press the program selection key

 and simultaneously start the centrifuge. As long as you keep the key pressed the selective mode is active.

Pressing the upward key , you can switch back and forth between the signal menu "beep" and the time menu "t-set".



After selecting the time menu "t-set", you can switch between the standards time mode "00.0" and the extended time mode "00".h by pressing the upward key .

The time input in excess of 10 hours is set in one hour increments.

## Selecting the temperature

You can select the temperature in the range of -9 °C to +40 °C.

To adjust the temperature, proceed as follows:

1. Press one of the "set" keys  (for an increase) or  (for a decrease) in the "temperature" section of the control panel once to switch from the actual to the set point mode.
2. By **briefly** pressing the input key you can now raise or lower the run time in 1° steps.





3. If you keep the selected key pressed, the display changes continuously slowly at first and then at accelerated paces up or down.
4. Release the key as soon as you have reached the desired value, and adjust if necessary by repeatedly pressing the key.

The temperature display flashes for a number of seconds, then changes to the current value display. The temperature set point is now stored.

## Pretemp function

The Pretemp function permits easy and quick pre-temperature-regulation of the empty rotor.

Upon calling this function by pressing the key , all you have to do is enter the desired temperature.

After actuating the start key , the rotor is pre-tempered with an optimum rotational speed set by the pre-temperature-function.

The actually achieved temperature change in the pre-temperature run time depends on the rotor used and the ambient temperature. Occasionally multiple pre-temperature runs are necessary to achieve the desired rotor temperature.

## Starting the centrifuge

Once the rotor is properly installed, the main switch is turned on and the lid is closed, you can start the centrifuge.

Press the "start" key  in the control panel. The centrifuge accelerates to the selected value. Simultaneously, the time display starts counting down from the selected set time, giving the remaining run time in minutes (during continuous operation the time display goes forward).

If a value exceeding the maximum permissible speed or RCF of the respective rotor was entered, this is indicated after the start of the centrifuge by the alternately flashing messages "rotor" and the maximum permissible value for the inserted rotor.

Within 15 seconds you may adopt this value by again pressing the "start" key; the centrifugation is then continued. Otherwise the centrifuge stops, and you must enter a permissible value.

You cannot open the lid during the run.

## Imbalance display

If rotor imbalance is detected, shortly after the rotor reaches 300 rpm, the message "bAL" will appear in the speed display.



The run is terminated, and you may restart the centrifuge after correcting the imbalance (check loading).

## Changing the settings during the run

You can change all settings during a run. By pressing any one of the "set" keys in the control panel once, you can switch from the actual to the set point mode.

The to-be-adjusted setting flashes and can then be altered. Once the data input is finished and the display has changed to the actual value display mode, the new settings become operative.

## Stopping the centrifuge

### Stopping with preset run time

Normally the run time has been selected, and all you have to do is to wait until the centrifuge terminates the run automatically at the end of the set time.

As soon as the speed reaches zero, the display reads "end". You can now open the centrifuge by pressing the "open lid" key  and remove your samples.

If the lid has not been fully lifted out of the lid lock, the message "lift lid" appears (you must manually lift the lid).

You can manually stop the centrifuge at any time by pressing the "stop" key .

At this point the remaining run time is displayed.

### Stopping with continuous operation

If you have chosen continuous operation, you must stop the centrifuge manually. Press the "stop" key  in the control panel. The centrifuge starts deceleration with the preset deceleration profile.

The display reads "end", and you can open the lid by pressing the "open lid" key  and remove your samples.

## Temperature control during standby

Temperature control becomes active once the rotor has been identified. This is the case after a centrifugation run exceeding 300 rpm. At standby the display reads "end".

If the rotor has not been identified (lid has been closed and the "start" key  has not yet been pressed, speed panel shows "0" with flashing point), the instrument regulates the temperature so that the samples cannot freeze in any one of the usable rotors.

If you find the systematic deviation in temperature of up to 4 K unacceptable, you have to start the centrifuge for a short period of time until the rotor is identified.

## Working with programs

The 4 program selection keys offer the option of storing and recalling the individual centrifugation processes.



### Program display

By actuating one of the program selection keys, the specific set point values stored are displayed.

### Entering/changing a program

All program places have been factory-set at the same values.

To change these values, proceed as follows:

- Enter the desired parameters
  - Only the selection panel affected by the changes is flashing.
- After entering all set point values, press the desired program selection key for approx. 3 Seconds:
  - The entering is confirmed by the signal, the new program is stored.

Repeat the process to set values to additional program places.

## Centrifuging with a program

After closing the centrifuge lid, call the desired program memory number using the program selection key and press the start key .

If the rotor is started with a program the speed or RCF set point value which exceeds the permissible value of the inserted rotor, or the RCF/set point which is below the rotor-specific minimum, the program selection keys LED of the program chosen beforehand will be switched off after the rotor identification.

## "Quick Run"

For short-time operation, the *Multifuge*<sup>®</sup> is equipped with a "quick run" function.

Short-time centrifugation is started by pressing the "quick run" key  continuously; it stops as soon as the key is released.

In this mode the centrifuge accelerates with full power up to the maximum speed. The set speed or RCF is ignored in this case.



**Depending on the rotor, the centrifuge accelerates to the maximum speed!**

**Check carefully whether you have to maintain a specific speed for your application.**

During acceleration the time is counted forward in seconds. The display remains until the centrifuge lid is opened.

## Removing the rotor

1. Open the centrifuge lid.
2. Remove the rotor cover (on applicable rotors).
3. Unscrew the clamping sleeve counterclockwise using the socket wrench supplied with the instrument until no resistance exists.
4. Grab the rotor with both hands and carefully pull it perpendicularly off the drive shaft. Make sure not to tilt it.



**Grab rotor with both hands and pull upwards perpendicularly.**

When using an aerosol-tight bio-containment cover, you may remove the respective rotor from the drive shaft without opening the cover! You may then open the rotor e.g. in a safety work bench and decontaminate it.

## Audible alarm

Accompanying all error messages, a warning signal is given out which can be silenced upon pressing any key.

You have the option of signaling the end of a run acoustically. To activate or deactivate this option, press the program key  and simultaneously switch on the centrifuge. As long as you keep this key pressed, the selection mode is active.

The speed panel shows "beep", and the time panel shows "on" or "off".

By actuating the upward-key  in the time panel the signal function can be switched on or off.



When the message "rotor" flashes, pressing the start key once is sufficient to turn off the warning signal and to accelerate the rotor to the maximum speed displayed by the instrument.

## Turning off the centrifuge

The centrifuge is turned off by switching the main switch into the "0"position.



The main power switch should be turned off after a complete centrifugation run. Without motor deceleration, it takes much longer until the rotor comes to a halt.

The centrifuge lid can only be opened automatically if the centrifuge is turned on!



## Maintenance and care

### Maintenance to be performed by the customer

For the protection of persons, environment and material you are obliged to clean the centrifuge regularly and to disinfect it if necessary.



**Unsuitable cleaning agents or disinfection procedures may damage the centrifuge and its accessories!**

**If you intend to use cleaning agents or disinfection procedures not recommended by the manufacturer, you have to ensure that the foreseen procedure does not cause any damages to the instrument by consulting the manufacturer!**

### Cleaning



**Pull mains plug before cleaning the instrument!**

Clean the case, the rotor chamber, the rotor and the accessories regularly, and in case of need. This is indicated both for reasons of hygiene and to prevent corrosion due to contamination sticking to the instrument and its accessories.

Clean them with mild agents of pH values ranging from 6 to 8.

For other cleaning agents please consult KENDRO Services!

Immediately after cleaning, dry the aluminum parts or put them into a warm-air dryer at a temperature not exceeding 50°C.



**During cleaning, liquids and especially organic solvents should not come into contact with the drive shaft and the ball bearing.**

**Organic solvents may decompose the lubricant of the motor bearing. The drive shaft may seize.**

#### **Instruments with refrigeration unit:**



If a strong ice sheet is present in the internal chamber, be sure to remove all condensation after defrosting!

#### **Please clean the venting slots regularly!**



**Before cleaning the venting slots, please disconnect the centrifuge from the mains supply.**

**Please pull mains plug!**

#### **Disinfection**

If a centrifuge tube containing infectious material leaks during a run, you have to disinfect the centrifuge immediately.



**Infectious material could enter the centrifuge if spills or tube breakage occur.**

**Danger of infection may occur upon contact! Take appropriate protective measures for personnel!**

**Pay attention to the permissible filling volumes and loading limits for the tubes!**

**In case of contamination the operator has to ensure that no other persons are at risk!**

**Contaminated parts will have to be decontaminated immediately.**

**If required, further protective measures have to be initiated.**

Rotor and rotor chamber must be treated with a neutral, universal disinfectant. Best suited for this purpose are disinfectant sprays, ensuring that all rotor and accessory surfaces are covered evenly.

- Please use 70% ethanol for disinfection.



**Please pay attention to the safety measures and handling requirements when applying these substances!**

For other disinfectants please consult KENDRO Services!

- You may disinfect the rotor and the accessories as described in the following section. Be sure to follow the pertinent safety procedures for handling infectious material.
  1. Pull mains plug.
  2. Unscrew the rotor chuck.
  3. Grab the rotor with both hands and pull it perpendicularly off the drive shaft.

4. Remove the centrifuge tubes and adapters, and disinfect them or dispose of them as necessary.
5. Treat the rotor and the rotor lid according to the instructions given for the disinfectant (soaking in liquid or spraying). You must strictly observe the specified action times!
6. Turn the rotor head down and drain off the disinfectant. Afterwards thoroughly rinse rotor and lid with water.
7. Dispose of the disinfectant according to valid regulations.
8. Aluminum rotors have to be treated with anticorrosive protective oil subsequently.

#### Disinfection with bleaching lye



**These agents contain highly aggressive hypochlorites and must not be used with aluminum rotors!**

### Decontamination

For general radioactive decontamination, use a solution of equal parts of 70% ethanol, 10% SDS and water. Follow this with ethanol rinses, then de-ionized water rinses, and dry with a soft absorbent cloth. Dispose of all washing solutions in appropriate radioactive waste containers!

### Autoclaving



**Check whether autoclaving is permitted!**

You may autoclave the rotor and the adapters at 121 °C.

Maximum permissible autoclaving cycle: 20 min at 121 °C.

The rotor must be cleaned and rinsed with distilled water before being autoclaved. Remove the rotor lid, the centrifuge tubes and the adapters. Place plastic rotors on an even surface to avoid deformation.



**Chemical additives to the steam are not permitted.**



**Never exceed the maximum permissible values for autoclaving temperature and autoclaving time.**

**Should the rotor show signs of wear, you must stop using it!**

Corrosion protective oil 7000 9824 is delivered with the centrifuge.

## **The KENDRO service offer**

Kendro Laboratory Products recommends annual servicing of the centrifuge and the accessories by authorized customer service or trained professionals. The customer service personnel inspect:

- the electrical installations
- the suitability of the location
- the lid lock mechanism and the safety circuit
- the rotor
- the rotor fastening and the drive shaft

Defective material is exchanged.

KENDRO offers inspection and service contracts covering it. Inspection costs are charged as flat-rate contracts.

Necessary repairs are carried out free of charge within the warranty conditions, and requires payment after expiration of the warranty period.

## **Warranty conditions**

The warranty period starts on the day of delivery. Within the warranty period the centrifuge is repaired or replaced free of charge if there are provable faults in materials or workmanship.

Conditions for a warranty are:

- the centrifuge is used according to the instructions of use
- mounting, extensions, settings, alterations or repairs are carried out exclusively by personnel authorized by KENDRO
- the required maintenance and care procedures are carried out regularly.

Notes

## Troubleshooting

### Emergency lid release

In case of a power failure the lid cannot be opened normally using the electrical lid unlocking mechanism. To permit unloading in this case, the centrifuge is equipped with an emergency override release. However, you may only use this system in case of emergency.



**Rotors can spin at high speed! Touching them may cause severe injuries!**

**Always wait for several minutes until the rotor has come to a complete stop. In case of a power outage, the brake does not function, and deceleration takes much longer than normal!**

Proceed as follows:

1. Make sure that the rotor is at a complete stop (observe through window in the cover).



**During a power outage, it is impossible to lock the lid once the emergency lid release has been used. Never stop the rotor using your hands or using tools!**

2. Unplug the main power cord.
3. Facing the centrifuge under the left-hand side, there is a plastic plug that can be removed using a screwdriver. After removal, use your fingers or a pair of pliers to pull the attached cord and activate the manual door override. The lid will open and you can remove your samples.



Emergency release

4. Afterwards, push the cord back into the instrument and reinsert the plastic plug.

Once the power is restored, you can connect the instrument to the main supply and turn it on.

Following the self test of the centrifuge, the lid may be closed and locked with the motor.

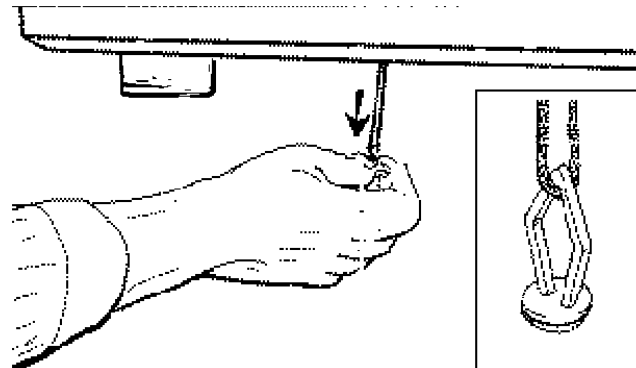



## Error troubleshooting



If problems other than those described in the following tables arise, you must contact KENDRO service.

Error	Symptom	Possible causes and corrective measures
Displays remain dark	The drive stops. The rotor stops without deceleration. The lid cannot be opened.	<b>Mains voltage disconnection</b> 1. Is the mains plug turned on? 2. Check the main connection. 3. If the main connection is ok, contact the nearest KENDRO service station.
Displays fail briefly.	The drive stops suddenly. The rotor stops without deceleration.	<b>Main connection was briefly interrupted</b> 1. Turn off main switch. 2. Check whether the mains power cord is connected properly. 3. Restart the centrifuge.
Lid cannot be opened.	Pressing the "open lid" key has no effect.	<b>Lid not correctly engaged or lid warped.</b> 1. Check if main connection is working and the instrument is switched on (display is lit). 2. Press the lid down in the middle of the front section once, and press the "open lid" key. 3. If this is unsuccessful, you may open the lid using the emergency lid release (see page 59).

## Troubleshooting

Error	Symptom	Possible causes and corrective measures
–	Centrifuge is exceptionally noisy.	<p><b>Imbalance.</b></p> <ol style="list-style-type: none"> <li>1. Stop the centrifuge by pressing the "stop" key, in case of emergency, unplug mains power cord.</li> <li>2. Wait until the centrifuge comes to a complete stop.</li> <li>3. Check whether the rotor is properly loaded.</li> <li>4. Check whether a broken tube, damage to the rotor or motor malfunction is responsible for the noise.</li> </ol> <p>If you cannot locate and solve the problem yourself, contact a KENDRO service station.</p>
Message "bAl" appears in display.	Rotor stops with deceleration.	<p><b>Imbalance switch actuated</b></p> <ol style="list-style-type: none"> <li>1. Open the instrument by pressing "open lid" key .</li> <li>2. Check whether the rotor is properly loaded.</li> <li>3. Check whether a broken tube or damage to the rotor was responsible for imbalance switch actuation.</li> <li>4. Check that the trunnions of the swinging bucket rotor have been properly lubricated.</li> </ol> <p>If you cannot locate and solve the problem yourself, contact the KENDRO service station.</p>

Error	Symptom	Possible causes and corrective measures
<p>Message "rotor" appears in display.</p>	<p>Rotor decelerates with delayed deceleration.</p>	<p><b>Set speed exceeds permissible maximum speed for the rotor.</b> (The same holds for RCF setting)</p> <p>A) For about 15 sec. the display shows alternately "rotor" and the maximum permissible speed or RCF for the installed, after the rotor identification. Within this period, it is possible to accept this value by again pressing the "start" key. The centrifugation will then be continued.</p> <p>B) Following onset of deceleration you must wait until the rotor has stopped. By opening and closing the lid you reset the message "rotor". After entering a permissible speed you can press start.</p>
<p>Display "OPEN" appears although lid is closed.</p>	<p>Will not start.</p>	<p><b>Lid not properly closed</b></p> <p>Open the lid and repeat locking procedure.</p>
<p>Message "Lid" appears flashing in the display.</p>	<p>Drive stops. Rotor stops without deceleration to standstill.</p>	<p><b>Lid was opened manually during the run.</b></p> <p>The instrument stops without deceleration. If you want to continue the run, you must switch the instrument off and on again.</p>
<p>Message "Lift Lid" appears in the display</p>	<p>Lid does not open automatically.</p>	<p><b>The lid has not been unlocked after release.</b></p> <ol style="list-style-type: none"> <li>1. Avoid laying objects onto the centrifuge lid.</li> <li>2. Lift the lid slightly.</li> </ol>

## Troubleshooting

Error	Symptom	Possible causes and corrective measures
E-01   E-13	Rotor stops without deceleration to standstill. Instrument cannot be operated.	<b>Internal program error.</b> Switch the instrument off and on again. If the error persists, contact KENDRO service.
E-14	Rotor stops with deceleration to standstill. Instrument cannot be operated.	<b>Overtemperature in the centrifuge tank.</b> Switch the instrument off and on again. If the error persists, contact a KENDRO service station.
E-15   E-16	Rotor stops with deceleration to standstill. Instrument cannot be operated.	<b>Temperature measurement error.</b> Switch the instrument off and on again. If the problem persists, contact a KENDRO service station.
E-17	Rotor stops with deceleration to standstill. Instrument cannot be operated.	<b>Maximum speed for the rotor identification exceeded.</b> Switch the instrument off and on again. If the problem persists, a contact KENDRO service station.
E-18	Instrument stops with deceleration to standstill after short starting-up.	<b>Bucket code for this rotor is not defined.</b> Check, whether the bucket is permitted for the inserted rotor (rotor program, page 16).

Error	Symptom	Possible causes and corrective measures
E-19	Instrument stops with deceleration to standstill after short starting-up.	<p><b>No rotor present or rotor identification impossible.</b></p> <p>A) Check if a certified rotor is inserted.</p> <p>B) Please pay attention to the legibility of the inscription of the swinging bucket rotor cross when it is installed. (rotor identification must show to the chamber bottom)</p> <p>C) For the swinging bucket rotor the set bucket type must be permitted for the operation in the respective rotor. Please note the hints of chapter "Bucket selection of swinging bucket rotors" (page 43) and compare the permitted rotors and rotor buckets in "table 1" on page 16.</p> <p>D) Following a brief power failure, the rotor could not be identified. Switch the instrument off and on again using the mains switch.</p>
E-20	Instrument does not start or decelerates to standstill.	<p><b>Rotor cannot be identified.</b></p> <p>A) Check if a certified rotor is inserted.</p> <p>B) Check if the rotor is completely fastened onto the motor shaft. For this, release the rotor fastening until you can lift and depress it easily. Now tighten the rotor fastening once again.</p>

## Troubleshooting

Error	Symptom	Possible causes and corrective measures
E-21	Instrument does not start or decelerates to standstill.	<p><b>No rotor present or rotor identification impossible</b></p> <p>A) Check if a certified rotor is inserted.</p> <p>B) Following a brief power failure, the rotor could not be identified. Switch the instrument off and on again using the main switch.</p>
E-22   E-23	<p>Rotor stops without deceleration to standstill.</p> <p>Instrument cannot be operated.</p>	<p><b>Error in speed measurement</b></p> <p>Switch the instrument off and on again. If the error persists, contact the KENDRO service station</p>
E-24   E-27	Instrument cannot be operated.	<p><b>Wrong status information from lid lock.</b></p> <p>Switch the instrument off and on again. If the error persists, contact the KENDRO service station.</p>
E-28	Instrument decelerates after a short starting-up.	<p><b>Motor runs in wrong rotational direction.</b></p> <p>Switch the instrument off and on again. If the error persists, contact the KENDRO service station.</p>

Error	Symptom	Possible causes and corrective measures
E-29	Motor does not start.	<p><b>Motor or rotor blocked.</b></p> <ol style="list-style-type: none"> <li>1. Switch instrument off and on again using the main switch.</li> <li>2. Open the lid.</li> <li>3. Check whether the rotor can turn freely.</li> </ol> <p>If you cannot clear the malfunction, contact the KENDRO service station.</p>
E-30	Rotor stops without deceleration to standstill or does not start.	<p><b>Control voltage breaks down.</b></p> <p>Switch the instrument off and on again. If the error persists, contact the KENDRO service station.</p>
E-31	Rotor stops without deceleration to standstill or does not start.	<p><b>Overtemperature in the motor.</b></p> <ol style="list-style-type: none"> <li>1. Turn instrument off and unplug mains power cord.</li> <li>2. Check and clean ventilation slots if necessary.</li> <li>3. After about 60 min. you can restart the instrument.</li> </ol> <p>Observe the max. permissible environmental temperature! If the error persists, contact the KENDRO service station.</p>
E-32	Rotor stops without deceleration to standstill or does not start.	<p><b>Overtemperature in the electronics.</b></p> <ol style="list-style-type: none"> <li>1. Turn instrument off and unplug mains power cord.</li> <li>2. Check and clean ventilation slots if necessary.</li> <li>3. After about 60 min. you can restart the instrument.</li> </ol> <p>Observe the max. permissible environmental temperature! If the error persists, contact the KENDRO service station.</p>

## Troubleshooting

Error	Symptom	Possible causes and corrective measures
E-33	Rotor stops without deceleration to standstill or does not start.	<p><b>Overpressure in the refrigeration system</b></p> <ol style="list-style-type: none"> <li>1. Turn instrument off and pull main plug.</li> <li>1. Check and clean ventilation slots if necessary.</li> <li>2. After about 60 min. you can restart the instrument.</li> </ol> <p>Observe the max. permissible environmental temperature! If the error persists, contact the KENDRO service station.</p>
E-34	Rotor stops without deceleration to standstill or does not start.	<p><b>Overvoltage in the intermediate circuit.</b></p> <p>Switch the instrument off and on again.</p> <p>If the error persists, contact the KENDRO service station.</p>
E-35	Rotor stops without deceleration to standstill or does not start.	<p><b>Overcurrent in the intermediate circuit.</b></p> <p>Switch the instrument off and on again. If the error persists, contact the KENDRO service station.</p>
E-36   E-38	Rotor stops without deceleration to standstill.  Instrument cannot be operated.	<p><b>Overcurrent or error in current measurement.</b></p> <p>Switch the instrument off and on again.</p> <p>If the error persists, contact the KENDRO service station.</p>
E-39	Rotor stops without deceleration to standstill.  Instrument cannot be operated.	<p><b>Speed control measurement exceeds permissible rotor speed.</b></p> <p>Switch the instrument off and on again.</p> <p>If the error persists, contact the KENDRO service station.</p>



Error	Symptom	Possible causes and corrective measures
E-40	Rotor stops without deceleration to standstill. Instrument cannot be operated.	<p><b>Acceleration of rotor too slow</b></p> <p>Open the lid and check the load!</p> <ul style="list-style-type: none"> <li>- Significant imbalance caused by missing bucket</li> <li>- Tubes or adapter do not fit (rotor is rubbing the chamber or the cover)</li> <li>- Micro plates carriers on the motor cover</li> </ul> <p>If the error persists, contact the KENDRO service station.</p>

## Contacting Kendro Service

Should you require help from our service station, please indicate the catalog and serial number of your instrument. You will find the pertinent information at the specifications, near the socket for the main plug.

Moreover it is helpful for our service representative to know your software version. You can determine the software version as follows:

1. Switch the instrument off.
2. Keep selection key **2** pressed and switch on the instrument

For about 1 sec all displays read:



Subsequently, the following readings will be displayed for 5 seconds each:  
(Numbers are examples)

Software version keyboard	__526	__2
Software version	__528	__6
NV-RAM version	__4468	__7

The value in the time panel indicates the development stage.

The last information displayed indicates the current cycle status.

Cycle counter	__235	__CY
---------------	-------	------

The values given are only examples!

During the subsequent program test, the message  
\_TEST PRO / 4 ... 1\* is displayed.

(\* only for instruments with refrigeration system)

## Technical Data

Features	Specification								
Ambient conditions	<ul style="list-style-type: none"> <li>- indoor use</li> <li>- maximum elevation 2000 m (6562 ft) above sea level</li> <li>- max. relative humidity 80 % up to 31°C (88°F), linearly decreasing down to 50 % relative humidity at 40°C (104°F).</li> </ul>								
Ambient temperature allowed	+2 °C to +40 °C (36°F to 104°F)								
run time	<ul style="list-style-type: none"> <li>- standard mode : 1min – 9 h 59 min, hold = permanent</li> <li>- extended mode : 1min – 99 h, hold</li> </ul>								
maximum speed ( $n_{max}$ )	15 000 rpm (rotor-dependent, adjustable in steps of 10)								
minimum speed ( $n_{min}$ )	300 rpm								
maximum RCF	24 652 (micro liter rotor 48 x 2ml 7500 3348)								
maximum kinetic energy	<table style="width: 100%; border: none;"> <tr> <td style="width: 30%;"></td> <td style="width: 30%;">Multifuge® 1 S</td> <td style="width: 30%;">34.3 kNm</td> <td style="width: 10%;">(25 298 ft.lb)</td> </tr> <tr> <td></td> <td>Multifuge® 1 S-R</td> <td>34.3 kNm</td> <td>(25 298 ft.lb)</td> </tr> </table>		Multifuge® 1 S	34.3 kNm	(25 298 ft.lb)		Multifuge® 1 S-R	34.3 kNm	(25 298 ft.lb)
	Multifuge® 1 S	34.3 kNm	(25 298 ft.lb)						
	Multifuge® 1 S-R	34.3 kNm	(25 298 ft.lb)						
noise at maximum speed	<table style="width: 100%; border: none;"> <tr> <td style="width: 30%;"></td> <td style="width: 30%;">Multifuge® 1 S</td> <td style="width: 30%;"><math>&lt; 64</math> dB (A)</td> <td style="width: 10%;"></td> </tr> <tr> <td></td> <td>Multifuge® 1 S-R</td> <td><math>&lt; 54</math> dB (A)</td> <td></td> </tr> </table> <p>(sound pressure level of emission according to DIN EN ISO 11 201)</p>		Multifuge® 1 S	$< 64$ dB (A)			Multifuge® 1 S-R	$< 54$ dB (A)	
	Multifuge® 1 S	$< 64$ dB (A)							
	Multifuge® 1 S-R	$< 54$ dB (A)							
Temperature set range	-9 °C to +40 °C								
Dimension (H x W x D)	<table style="width: 100%; border: none;"> <tr> <td style="width: 30%;"></td> <td style="width: 30%;">Multifuge® 1 S</td> <td style="width: 30%;">365 mm x 500 mm x 615 mm</td> <td style="width: 10%;">( 14.37 x 19.69 x 24.21 inches )</td> </tr> <tr> <td></td> <td>Multifuge® 1 S-R</td> <td>365 mm x 686 mm x 665 mm</td> <td>( 14.37 x 27.0 x 26.18 inches )</td> </tr> </table>		Multifuge® 1 S	365 mm x 500 mm x 615 mm	( 14.37 x 19.69 x 24.21 inches )		Multifuge® 1 S-R	365 mm x 686 mm x 665 mm	( 14.37 x 27.0 x 26.18 inches )
	Multifuge® 1 S	365 mm x 500 mm x 615 mm	( 14.37 x 19.69 x 24.21 inches )						
	Multifuge® 1 S-R	365 mm x 686 mm x 665 mm	( 14.37 x 27.0 x 26.18 inches )						

## Technical Data

Features	Specification
Weight without rotor      Multifuge® 1 S Multifuge® 1 S-R	92 kg    ( 203 lb ) 118 kg    ( 259 lb )
<p><b>Testing standards</b></p> <p>- all devices manufactured and examined in agreement with:</p> <p>- for 120 V only</p> <p>- for 230 V only</p>	<p>IEC 61010-1:1990 + amendment 1:1992 + amendment 2:1995            IEC 61010-2-020:1993 + amendment 1:1996                - Pollution degree 2, - Overvoltage category II</p> <p>CAN/CSA-C22.2 No. 1010-1.92            CAN/CSA-C22.2 No. 1010-1.B97 amendment 2            UL 3101-1</p> <p>EN 292            EN 61 010-1, EN 61 010-2-020            EN 61326, EN 55011 B</p>

**Electrical connections / fuses**

Order no.	Voltage	Frequency	Nominal current	Power consumption	Fuse protection of instrument - safety fuse * thermal excess current release	Fuse protection of building
Multifuge <sup>®</sup> 1 S 7500 4311	230 V	50/60 Hz	9.1 A	1300 W	12 A * 14 A	16 AT
Multifuge <sup>®</sup> 1 S 7500 4315	120 V	60 Hz	12.0 A	1200 W	12 A * 16 A	15 AT
Multifuge <sup>®</sup> 1 S-R 7500 4331	230 V	50/60 Hz	9.2 A	1520 W	12 A * 14 A	16 AT
Multifuge <sup>®</sup> 1 S-R 7500 4335	120 V	60 Hz	12.0 A	1440 W	12 A * 16 A	15 AT

---

Notes

---

## **Appendix**

### **Acceleration and deceleration profiles**

On the following pages you find acceleration and deceleration profiles for each rotor type respectively.

**Acceleration profiles**  
Swinging Bucket Rotor TTH 400 75002000

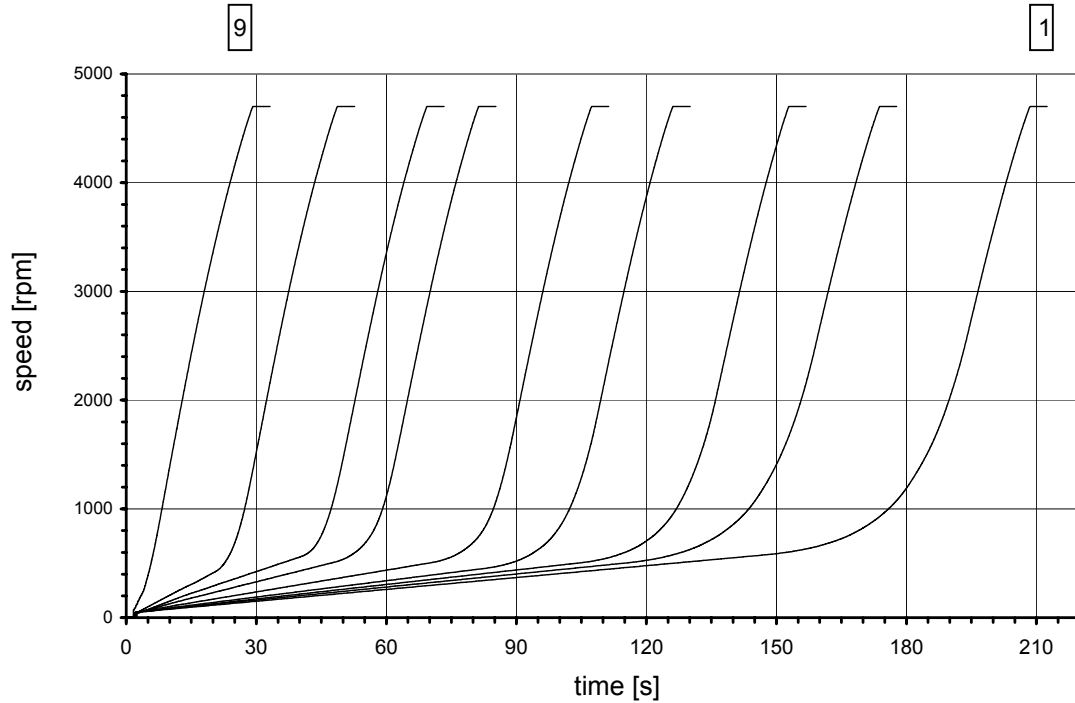



## Deceleration profiles

Swinging Bucket Rotor TTH 400 75002000

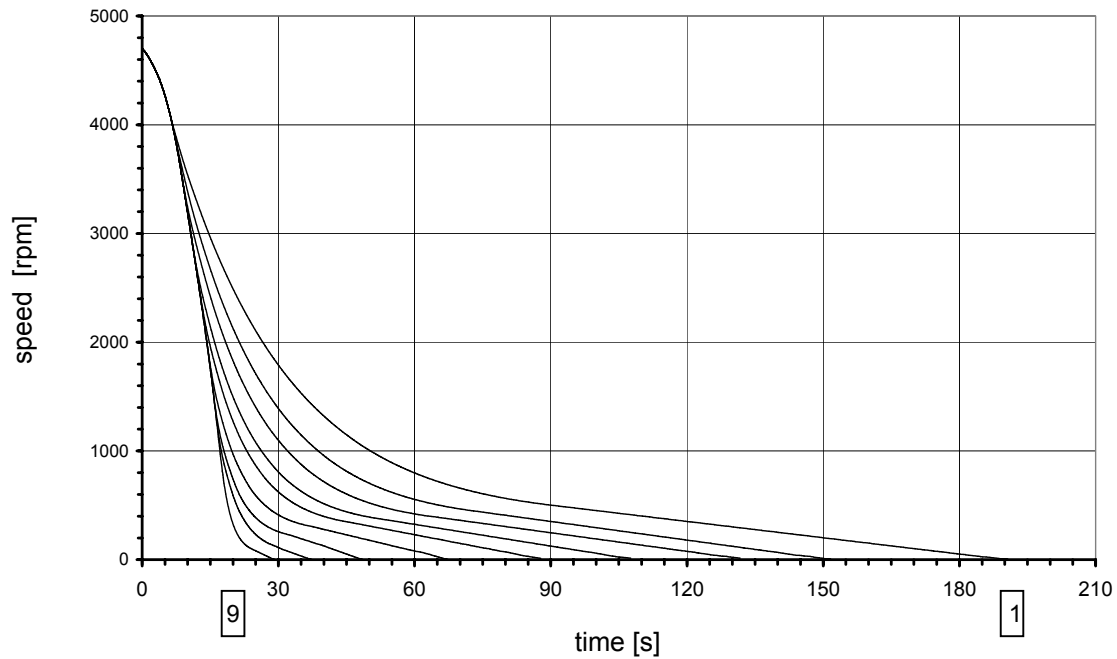

**Acceleration profiles**  
BIOshield® 600 Rotor 75002005

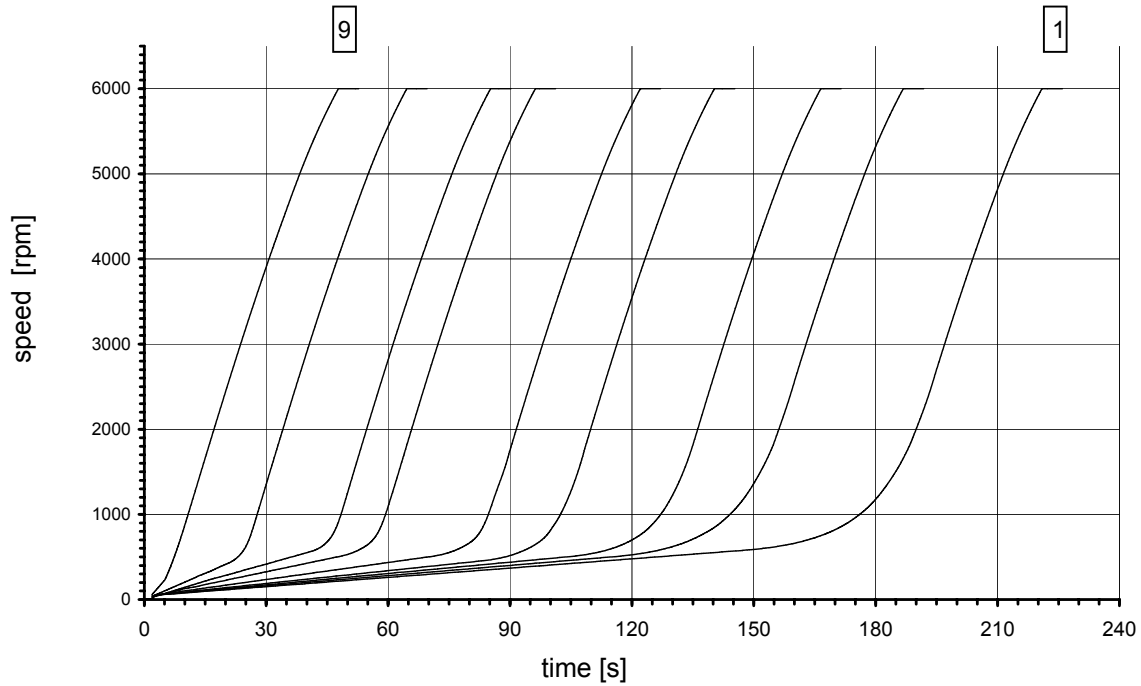

**Deceleration profiles**  
BIOshield® 600 Rotor 75002005

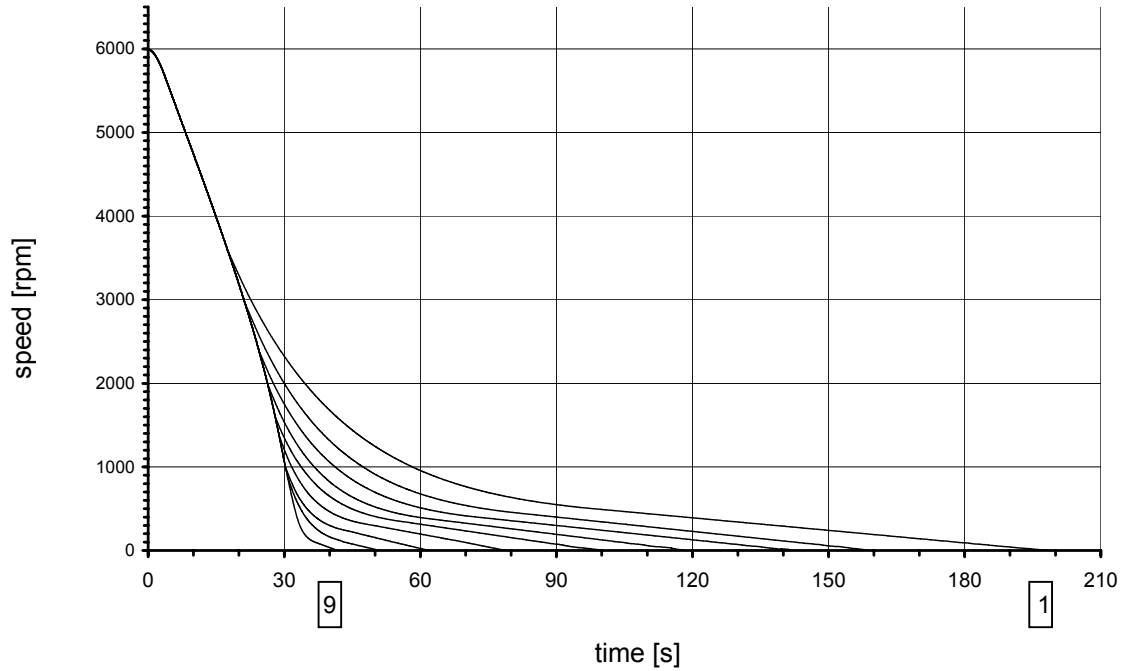

## Acceleration profiles

Micro plate carrier MP 3300 75002010

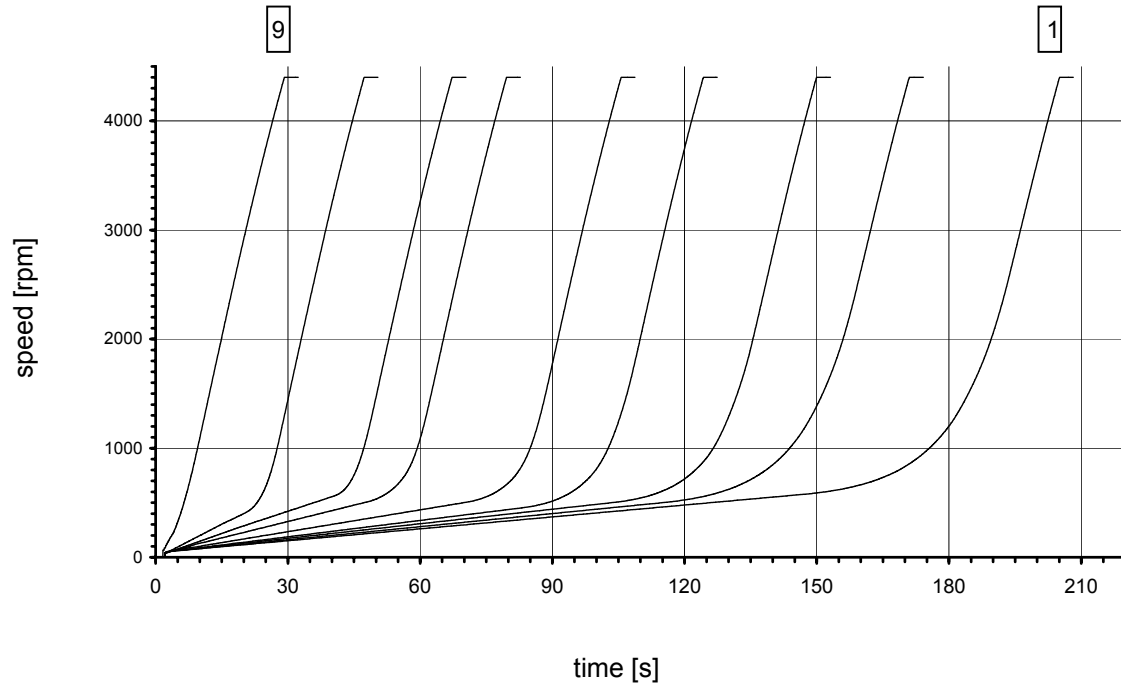

## Deceleration profiles

Micro plate carrier MP 3300 75002010

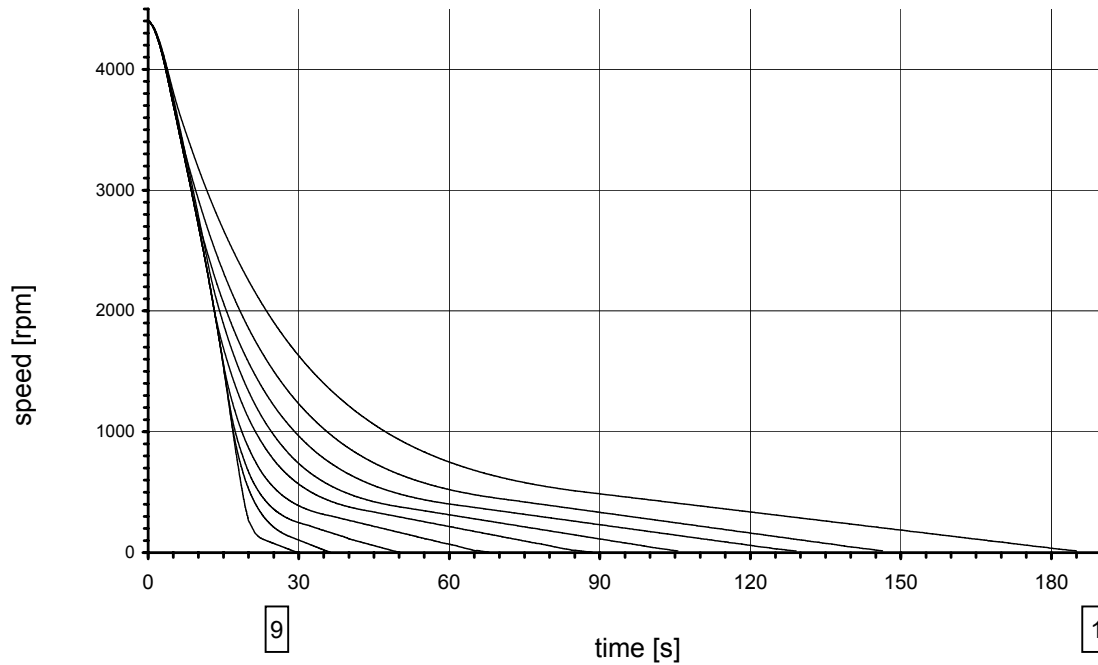

## Acceleration profiles

Fixed-Angle Rotor FA12.94 Highconic® 7500 2006

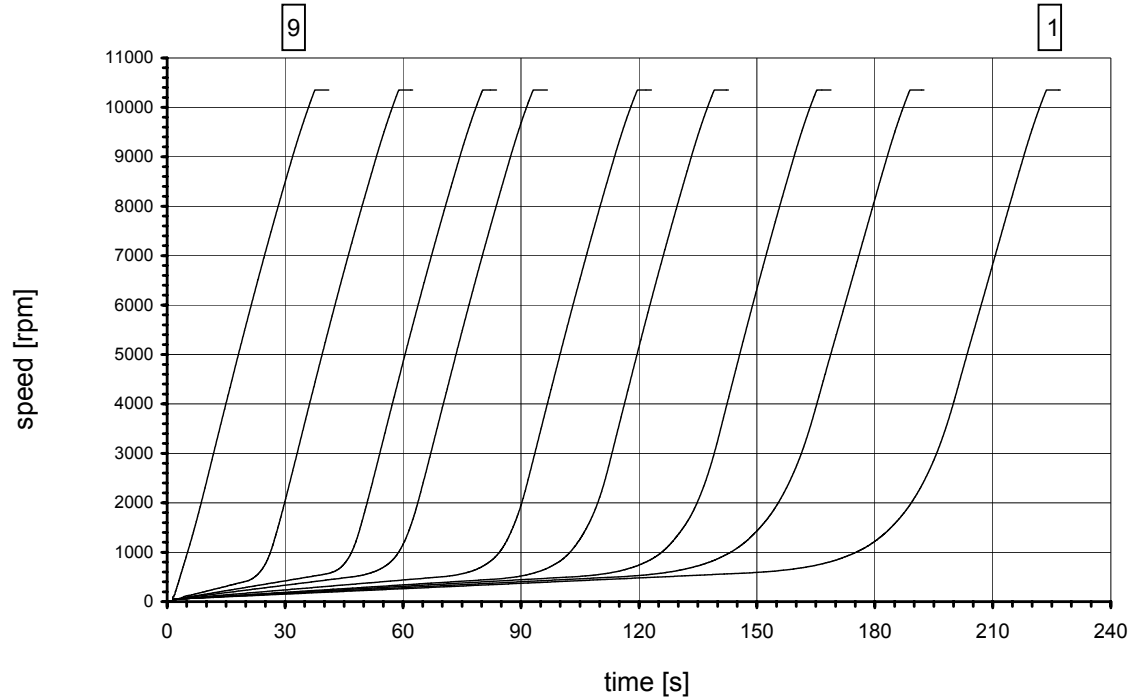

**Deceleration profiles**  
Fixed-Angle Rotor FA12.94 Highconic® 7500 2006

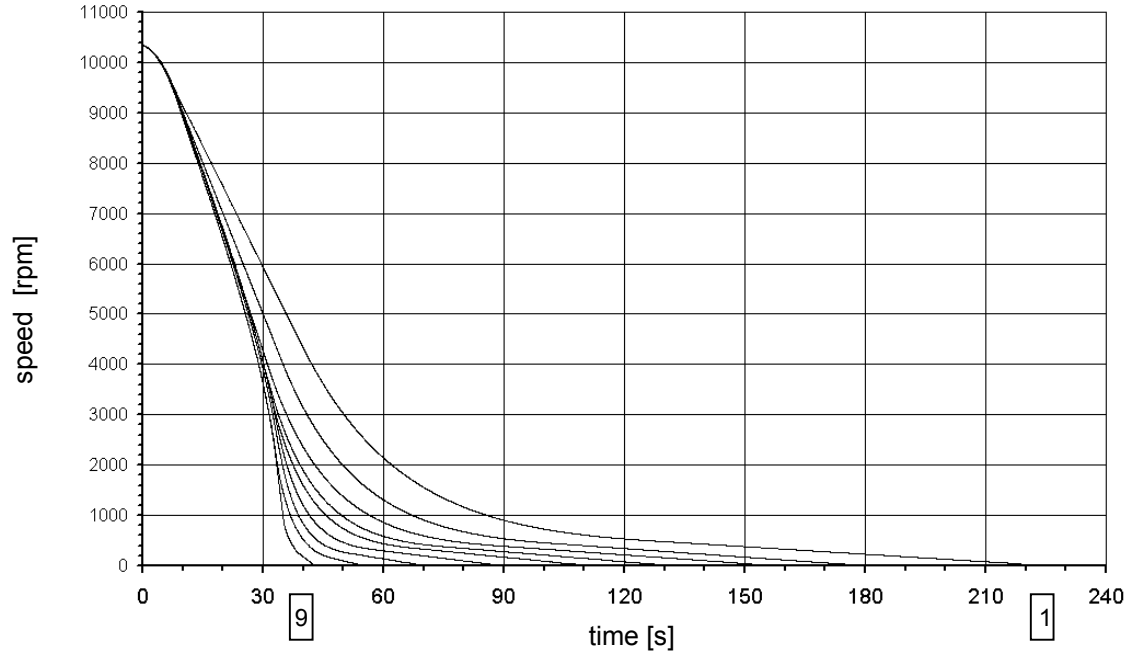

## Acceleration profiles

Micro Liter Rotor 48 x 2 ml 75003348

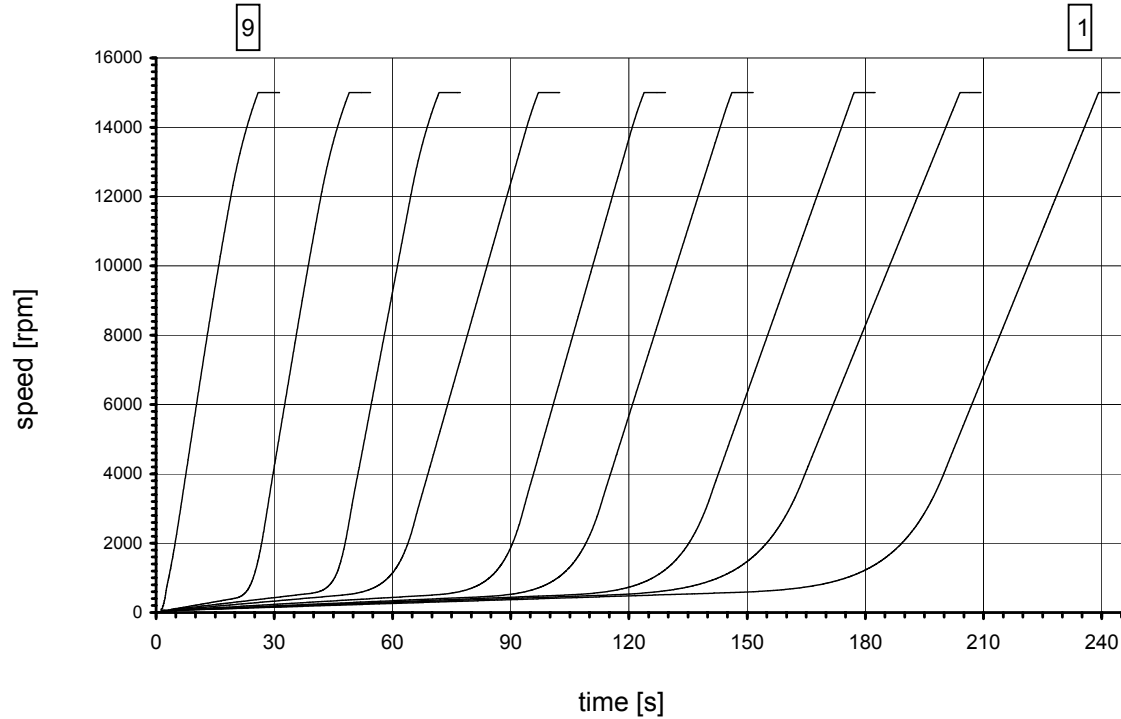



## Deceleration profiles

Micro Liter Rotor 48 x 2 ml 75003348

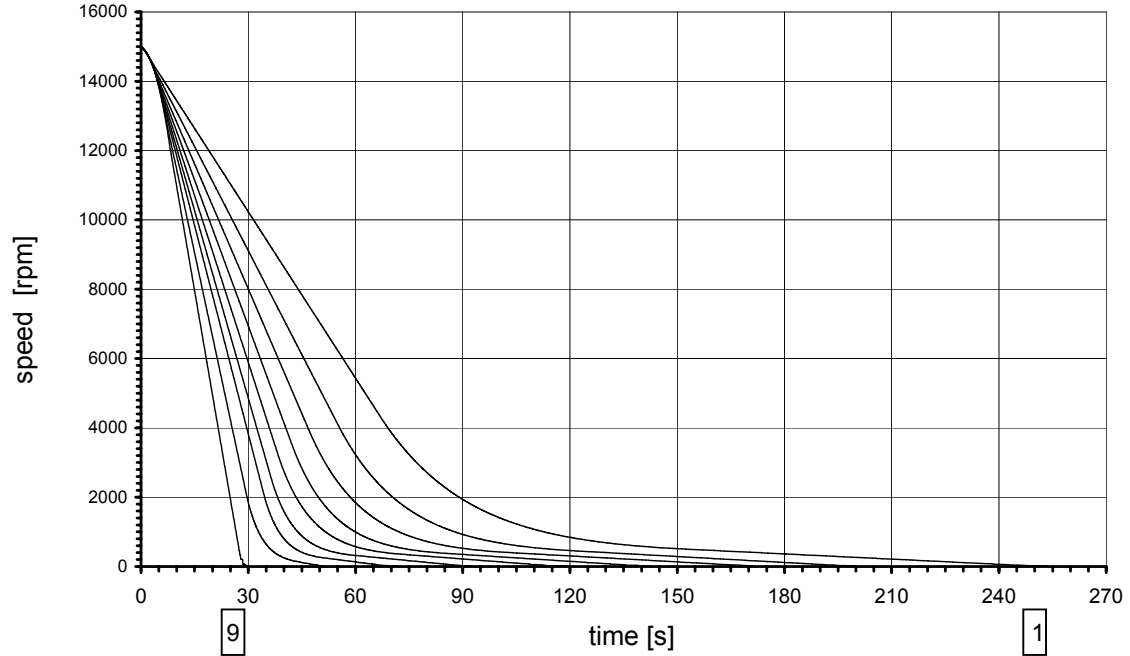



## Speed/RCF diagrams

\*  $n_{\max}$  = max. speed

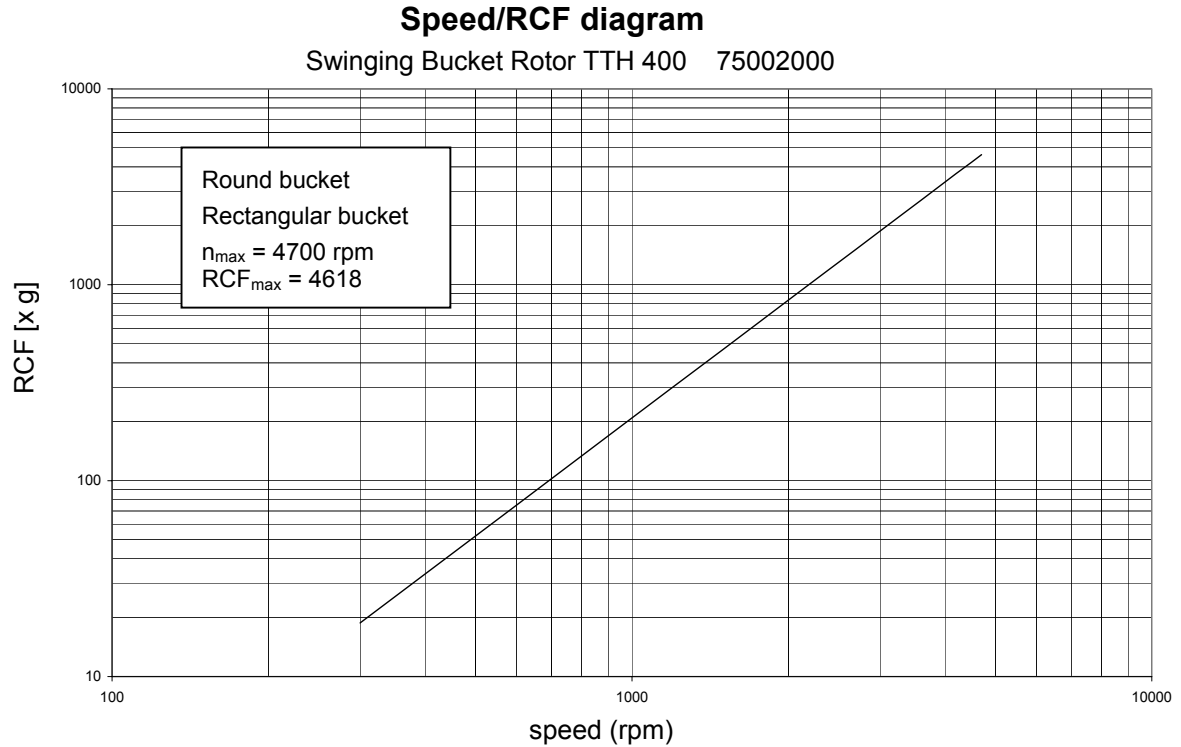

## Speed/RCF diagram

BIOshield® 600 Rotor 75002005

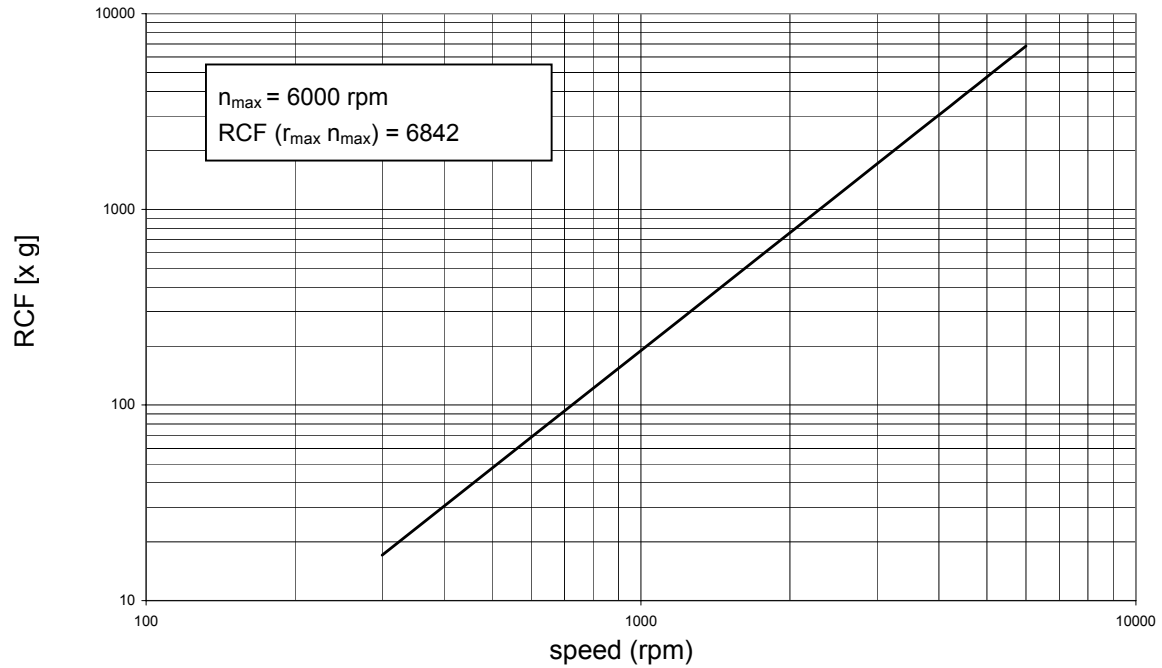

## Speed/RCF diagram

Micro plate carrier MP 3300 75002010

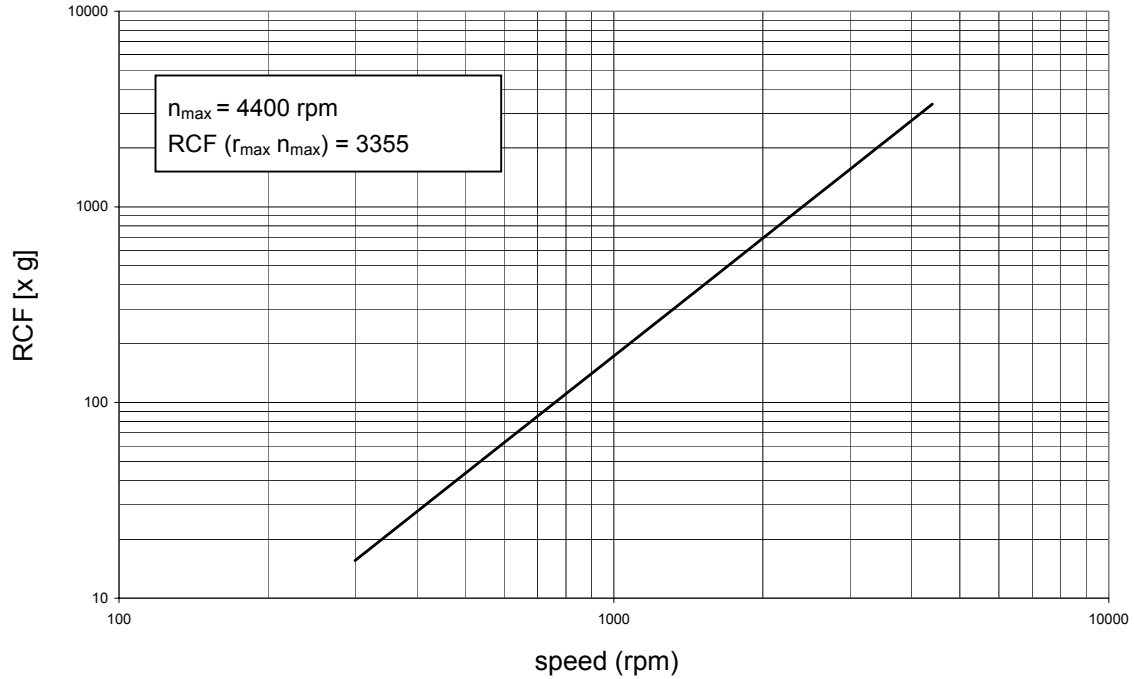

## Speed/RCF diagram

Fixed-Angle Rotor FA12.94 Highconic® 7500 2006

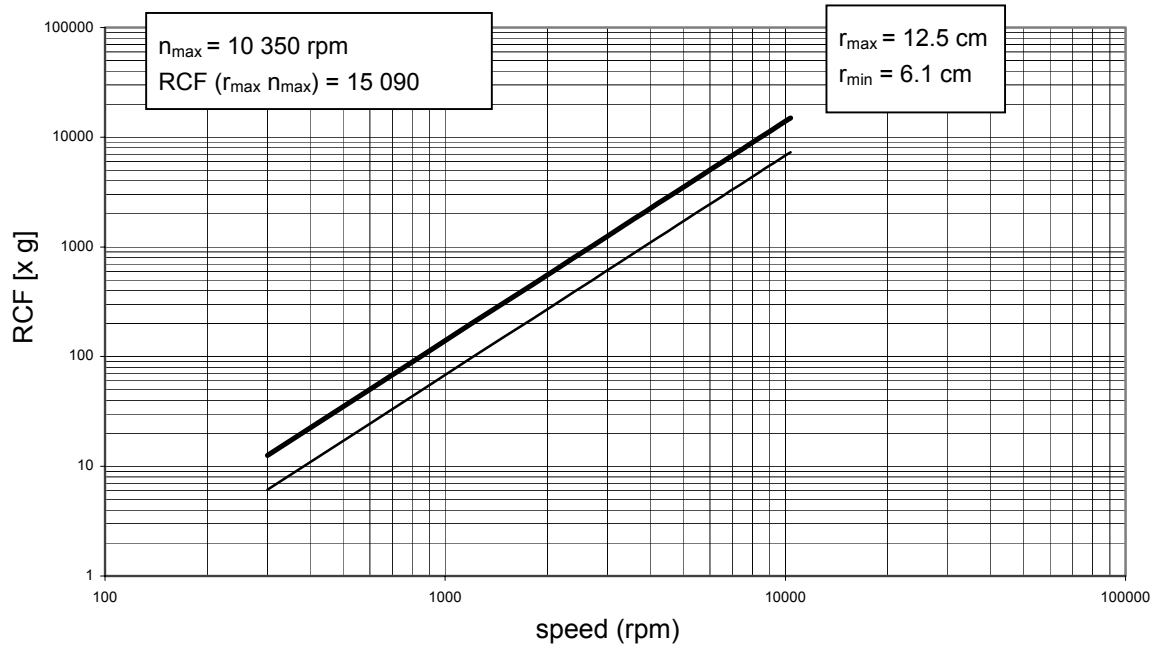

## Speed/RCF diagram

Micro liter Rotor 48 x 2 ml 7500 3348

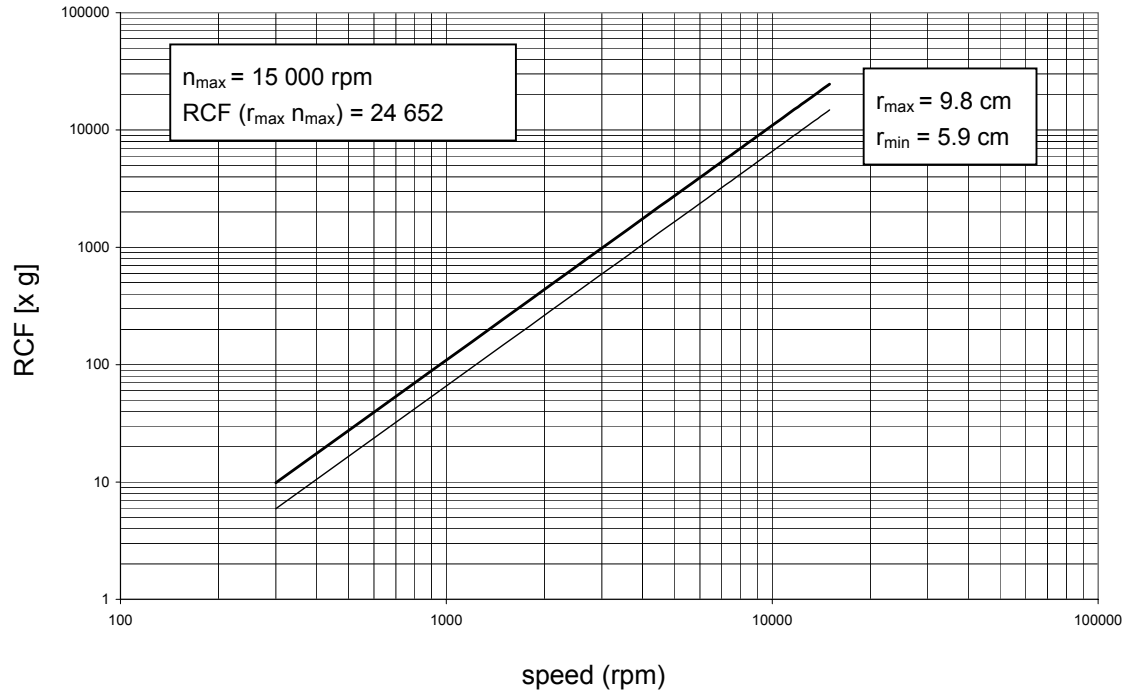





---

# Index

## A

- acceleration and deceleration curves · 75
- acceleration profiles · 7
- Acceleration/deceleration profile · 10
- actual values · 44
- adapter · 24
- aerosol-tight operation · 32
- aerosol-tightness
  - test · 36
- aluminum rotor: · 55
- approved rotors · 38
- audible signal
  - can be switched on or off · 52
  - switching on/off · 52
- autoclaving · 56
- autoclaving cycle
  - permissible maximum · 56

## B

- bAL · 48
- Basic unit/ function · 9

## C

- centrifuge exceptionally noisy · 62
- Centrifuge transport and installation · 13
- Centrifuging with a program · 50
- changing settings
  - during run · 48
- cleaning · 53
- closing the lid · 37
- collet chuck · 38
- common glass or plastic centrifuge tubes · 4
- conditions of warranty · 57
- Conformity · 5
- contamination
  - necessary measures · 54
- continuous operation · 46
- control panel
  - readings · 7
- corrosion · 4
- corrosive substances
  - protective tubes for corrosive substances · 4
- cycle counter · 70

---

## D

- dangerous chemicals · 3
- Deceleration curves · 43
- deceleration profiles · 7
- decontamination · 54
- Description · 7
- Description / feature · 9
- Diagnostic messages · 11
- disinfectant · 55
- disinfection · 4
  - procedure · 55
- disinfection with bleaching lye · 55
- displays
  - brief failure · 61

## E

- EASYset™
  - user interface · 10
- EASYset™ control panel · 7
- Emergency lid release · 59
- Entering parameters · 43
- Entering/changing a program · 50
- error codes
  - „Lid“ · 63
  - „OPEN“ with lid closed · 63
  - „rotor“ · 63

- error codes
  - „bAl“ · 62
  - E-01 ... E-40 · 64

## F

- filling the centrifuge tubes · 40
- fixed run time · 45

## G

- general view · 7, 8, 15, 16, 18, 19, 20, 22, 23
- goes forward · 48

## H

- handling the centrifuge · 4
- hazardous substances · 3
- hazards
  - symbols · 5
- hints
  - symbol · 5
- hLd · 45, 46

---

## I

- icons
  - for denoting dangers and potential damage · 5
- imbalance · 40, 41
- imbalance · 48
- imbalance detection · 8
- indoor use · 13
- infectious material
  - precautions in case of tube breakage · 54
- Inserting the centrifuge tubes · 41
- Installing the rotor · 38

## L

- lid
  - blockage · 61
- Lid lock with safety check · 8
- lid opening · 37
- lid release Emergency · 59
- lid unlocking mechanism
  - manual · 59
- limited life time · 40
- location · 13

## M

- maintenance · 53
- manual lid unlocking · 59
- manual stopping · 49
- max. tube dimensions · 25
- maximum filling volume · 35
- Maximum loading · 39
- maximum permissible filling volume · 34
- maximum permissible RCF · 48
- maximum permissible speed · 48
- Maximum RCF value · 16, 17, 21
- maximum sample density · 3
- microtest plates · 31
- minimum distance
  - from wall · 13

## O

- opening the lid · 37
- operation
  - short-time · 51
- organic solvents
  - not allowed for cleaning · 54

---

## P

- pathogenic microorganisms
  - protection against · 4
- Plastic sample tubes
- Pretemp function · 47
- pretemperature-regulations · 47
- problems
  - handling · 61
- program display
  - symbols · 50
- Program memory keys · 10
- program storing · 50
- protective tubes
  - for corrosive substances · 4

## Q

- quick run function · 51
- Quick run mode · 11

## R

- radius of centrifugation
  - for calculation of RCF value · 45
- RCF
  - maximum · 48

- RCF / speed display · 43
- RCF display
  - and rotor identification · 44
- RCF selection · 10
- RCF setpoint · 44
- RCF value · 7, 45
  - relative centrifugal force · 45
- RCF-value · 20, 22, 23
- RCF-value · 18, 19
- readings
  - of control panel during run · 7
- Regulations for prevention of accidents · 5
- relative centrifugal force · 45
- remain dark · 61
- rotor cover · 38
- rotor identification · 8
- rotor identification · 44
  - and RCF display · 44
- Rotor program for the Multifuge · 16
- rotors
  - approved · 38
- run profile · 7
- run time
  - range · 45
  - selection · 45

## S

- safety instructions · 3

---

- Safety instructions · 5
- safety measures · 3
- safety standards · 5
- safety zone · 3, 13
- sample density
  - maximum · 3
- sample tubes are approved · 40
- selecting
  - run time · 45
- Selecting speed · 44
- selecting the
  - temperature · 47
- Selecting the temperature · 47
- service · 57
- service contracts · 57
- setpoint values · 44
- setting
  - speed · 44
- settings
  - change during run · 48
- Short time centrifugation · 51
- short-time operation · 51
- signal · 52
- software check
  - internal · 37
- software version
  - determination · 70
- speed
  - maximum · 48
  - speed / RCF display · 43

- speed of centrifugation
  - for calculation of RCF value · 45
- Speed selection, · 10
- speed setting · 44
- Starting the centrifuge · 48
- stopping
  - manually · 49
  - with continuous operation · 49
- Stopping
  - with preset run time · 49
- substructure · 13
- Switching from speed to RCF display and vice versa · 43
- symbols
  - for hazards and dangers · 5

## T

- Technical Data · 71
- test
  - aerosol-tightness · 36
- The printed documents consist of the delivery notes and this Manual · 8
- time
  - counted forward in quick run mode · 51
- tools for installing the rotor · 38
- toxins
  - protection against · 4
- troubleshooting · 59
- t-set

---

time mode · 46  
tube  
breakage with infectious material · 54  
Turning the centrifuge off · 52

## **V**

volume

maximum filling · 35

## **W**

warning signal · 52  
warranty conditions · 57  
wear · 4

## For Ordering or Technical Information

**Asia Pacific** Kendro Laboratory Products International Sales · Asheville, NC · USA · Tel. +1 828-658 2711 · Fax +1 828-645 7581 · [info@kendro.spx.com](mailto:info@kendro.spx.com)

**Europe, Middle East, Africa**

Kendro Laboratory Products International Sales · Langenselbold · Germany · Tel. +49 (0) 6184-90 6940 · Fax +49 (0) 6184-90 7474 · [info.de@kendro.spx.com](mailto:info.de@kendro.spx.com)

**Latin America** Kendro Laboratory Products International Sales · Asheville, NC · USA · Tel. +1 828-658 2711 · Fax +1 828-645 7581 · [info@kendro.spx.com](mailto:info@kendro.spx.com)

**North America** Kendro Laboratory Products International Sales · Asheville, NC · USA · Tel. +1 828-658 2711 · Fax +1 828-645 3368 · [info@kendro.spx.com](mailto:info@kendro.spx.com)  
Sorvall and Heraeus products · Tel. +1 800-522 7746

**Internet** <http://www.kendro.com>



Kendro Laboratory Products GmbH  
Robert-Bosch-Straße 1  
D-63505 Langenselbold  
Telephone: +49 (0) 6184 90 6940

In the interest of continuous product development, we reserve the right to make changes without express notice.

20058041 Multifuge 1S/1S-R\_uk 04/04

Printed in Germany