



**INSTRUCTION MANUAL
21" COLOR TELEVISION
CTV-4016SR**







DEAR CUSTOMER

In order to achieve the best performance of your product, please read this instruction manual carefully before using, and keep it for future reference.

If you need extra support, please write to info@premiermundo.com



	CAUTION RISK OF ELECTRIC SHOCK, DO NOT OPEN	
<p>Caution: To reduce the risk of electric shock do not open this device, there are not serviceable parts for customers. Please refer any maintenance or repair to qualified personnel.</p>		
	<p>This sign means the existence of dangerous voltage at the inside of the unit, which states a risk of electric shock.</p>	
	<p>This sign means that there are important instructions of operation and handling in the manual that comes with this device.</p>	

PREMIER CUSTOMER SERVICE

Venezuela:	0800 ELECTRIC (353-2874)
Colombia:	01-900-331-PEJC (7352)
Panama:	300-5185
Website	www.premiermundo.com
E-mail:	servicioalcliente@premiermundo.com

NOTE

This unit may be submitted to changes in specifications, characteristics and/or operation without prior notice to the user, in order to continue improving and developing its technology.

Precaution

1. Read these instructions.
2. Keep these instructions.
3. Heed all warnings.
4. Follow all instructions.
5. Do not use this apparatus near water, the apparatus shall not be exposed to dripping or splashing and that no objects filled with liquids, such as vases, shall be placed on the apparatus.
6. Clean only with dry cloth.
7. Do not install this apparatus in windtight places such as the wall-unit. Do not block any ventilation openings.
8. Do not install near any heat sources such as radiators, heat registers, stoves, or other apparatus (including amplifiers) that produce heat.
9. Do not defeat the safety purpose of the polarized or grounding-type plug. A polarized plug has two blades with one wider than the other. A grounding type plug has two blades and a third grounding prong. The wide blade or the third prong are provided for your safety. If the provided plug does not fit into your outlet, consult an electrician for replacement of the obsolete outlet.
10. Protect the power cord from being walked on or pinched particularly at plugs, convenience receptacles, and the point where they exit from the apparatus.
11. Only use attachments/accessories specified by the manufacturer.
12. Use only with the cart, stand, tripod, bracket, or table specified by the manufacturer, or sold with the apparatus. When a cart is used, use caution when moving the cart/apparatus combination to avoid injury from tip-over.
13. Unplug this apparatus during lightning storms or when unused for long periods of time.
14. Refer all servicing to qualified service personnel. Servicing is required when the apparatus has been damaged in any way, such as power-supply cord or plug is damaged, liquid has been spilled or objects have fallen into the apparatus, the apparatus has been exposed to rain or moisture, does not operate normally, or has been dropped.

<p>CAUTION</p> 	<p>Danger of explosion if battery is incorrectly replaced. Replace only with the same or equivalent type. Batteries shall not be exposed to excessive heat such as sunshine, fire or the like. Used batteries should not be thrown into the garbage can, please leave them at an appropriate depot.</p>
---	---

<p>CAUTION</p> 	<p>Where the MAINS plug or an appliance coupler is used as the disconnect device, the disconnect device shall remain readily operable.</p>
---	--

<p>CAUTION</p> 	<p>These servicing instructions are for use by qualified service personnel only. To reduce the risk of electric shock, do not perform any servicing other than that contained in the operating instructions unless you are qualified to do so.</p>
---	--

Specifications

1. Television system
RF input: NTSC / PALM / PALN
Video input: NTSC / PALM / PALN
2. Receive frequency range
US CH
181 Channels (Air+CATV)
3. Picture resolution
Horizontal ≥ 220
Vertical ≥ 320
4. Intermediate frequency
Picture IF 45.75MHz
Volume IF 41.25MHz
5. Luminance grades: ≥ 8 grade
6. Sound power output: 3W \times 2
7. Power supply: AC 90-260V 50/60Hz
8. Power consumption: ≤ 75 W (standard status)
9. Screen size: 54cm
10. Dimension: 600(W)x333(D)x441(H)mm
11. Net Weight: 18.5kg

※ **Note:**

All specifications are subject to change without notice.
All quality and size are approximate value.

Note: We will not notify customers particularly when there is any change happened in the design and specification of the product. The pictures in the handbook may bear slight differences from the real one. Please take actual products as the standard.

Control Location

For control knobs (all panels subject to the real object), please refer to your own TV set.

Front and Back Control Panel

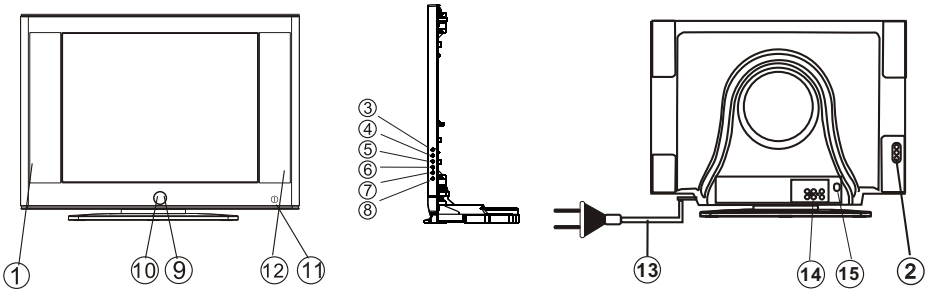

- | | |
|-------------------------|------------------------------|
| 1. Speaker | 9. Power Indicator |
| 2. Side AV In(Optional) | 10. Remote Sensor |
| 3. AV/TV Button | 11. Power Switch |
| 4. Menu Button | 12. Speaker |
| 5. Volume Down Button | 13. AC power Cord |
| 6. Volume Up Button | 14. Audio/Video-in/out |
| 7. Program Down Button | 15. Terminal Antenna(75 Ohm) |
| 8. Program Up Button | |

Operation of Function Board

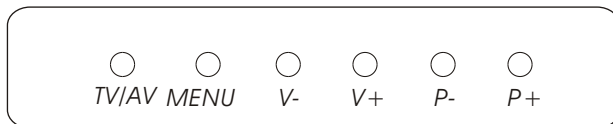

● OPERATION INSTRUCTIONS OF PANEL

First insert powerplug and then insert antenna or cable antenna into the socket of antenna.

● SWITCH ON AND OFF TV

When press Power button, power is connected. When press Power button again, power is off. When TV is at stage of sleep, it cannot be switched on or off by pressing the power button.

NOTE:

when TV is at stage of sleep, it can be switched on or off by pressing the sleep button on the remote controller.

CAUTIONS:

In case that electricity is cut when watching TV, switch off the power. If TV is not watched, please switch off the power. When TV is at stage of sleep, there is a part of circuit working and consuming electricity.

● Automatic Search Channel

Press "MENU" button and enter "Installation" with P+/P- button selected "Auto search" function and then press V+ or V- button starting to search the channels automatically.

Connection to Other Equipment

This TV set can be connected to videotape player, videodisc player, video camera, game player or audio player.

Front AV terminal

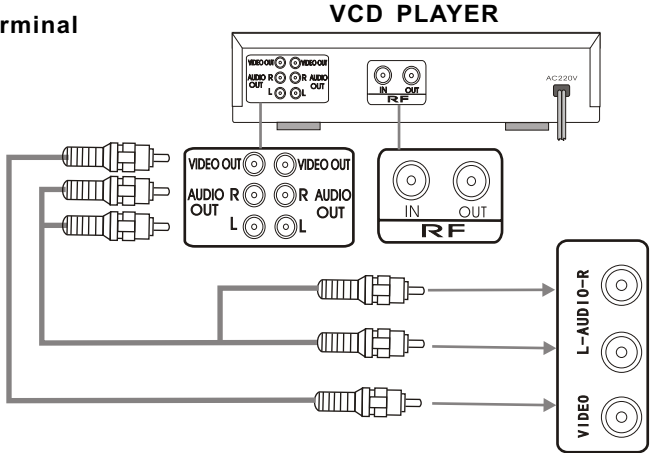

NOTE:

Video/ Audio equipment can be connected to sockets of AUDIO IN or VIDEO IN in rear

Back AV terminal

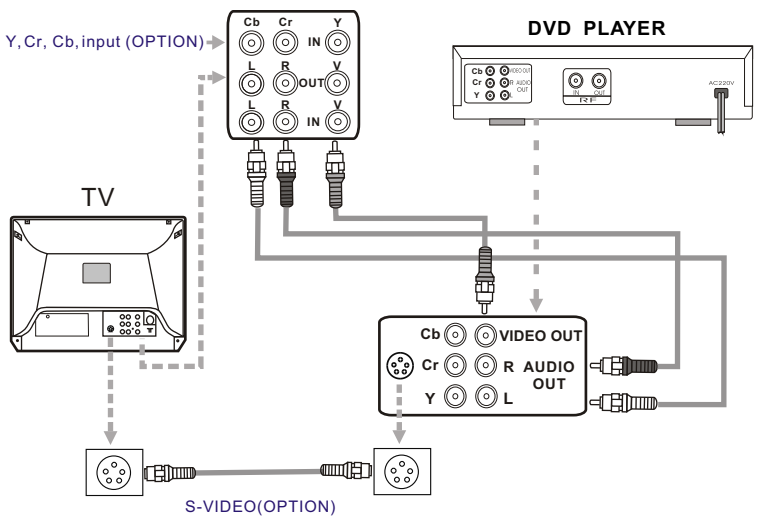



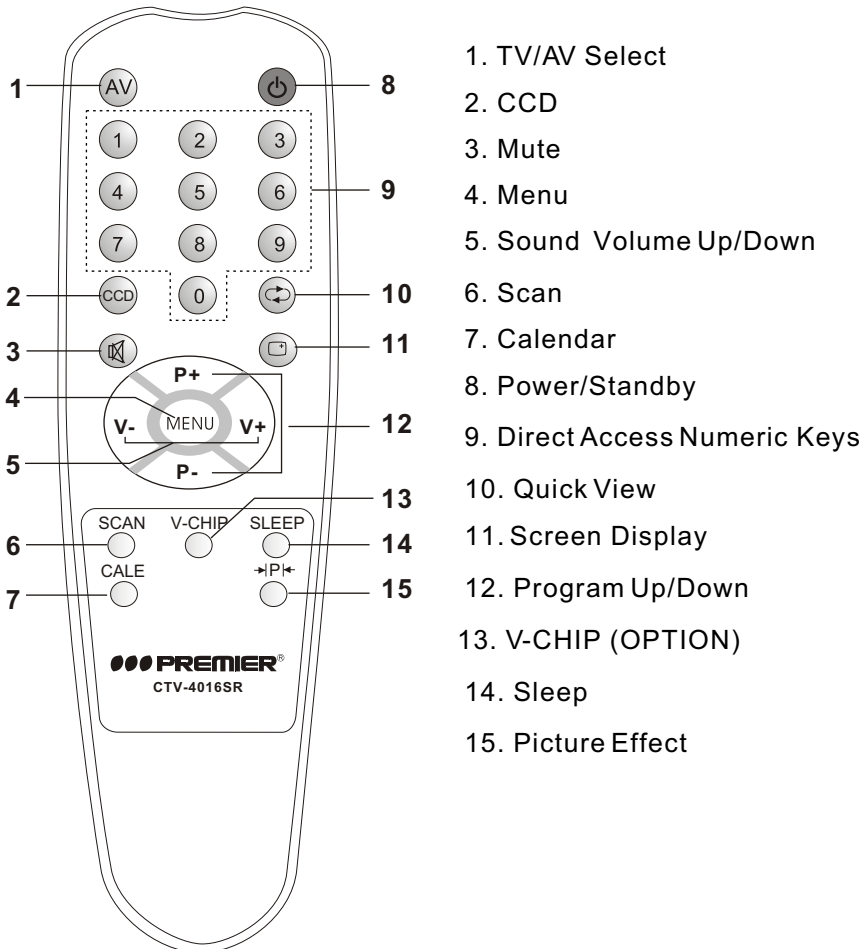

Remote Controller



1. TV/AV Select
2. CCD
3. Mute
4. Menu
5. Sound Volume Up/Down
6. Scan
7. Calendar
8. Power/Standby
9. Direct Access Numeric Keys
10. Quick View
11. Screen Display
12. Program Up/Down
13. V-CHIP (OPTION)
14. Sleep
15. Picture Effect

CHILD LOCK FUNCTION (OPTION)

Pressing and holding () key for more than 5 seconds, all the keys except () key and () key are locked, then pressing and holding () key for more than 5 seconds, all the keys the face panel are unlocked.

Don't mix different battery types. Take out of the batteries from the remote for long time of no use.

Control your TV

1) Power/Stand-By ON/OFF



With Mains status On, you can also turn off using Remote Control Hand Unit. This status is called Stand-By mode. In this mode, You can also turn on the TV by pressing the Program Up/Down keys on the front controls.

※ The TV has an Automatic Power OFF function. With no signal condition, the TV will automatically turn off after 10 minutes.

2) Program Up/Down

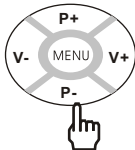

Press [P+] key, to change Program Up.
Press [P-] key, to change Program Down.

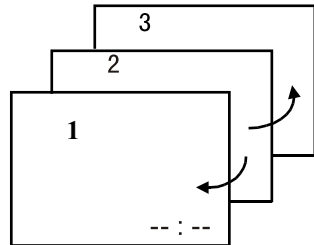

3) Direct Access Tuning

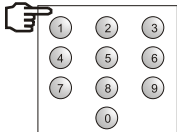

Using the numeric keys on Remote Control Hand Unit, Programs can be selected directly.

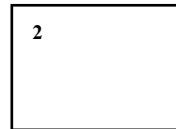

4) Volume Control

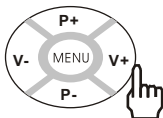

Press [V+] key, for Volume Up.
Press [V-] key, for Volume Down.

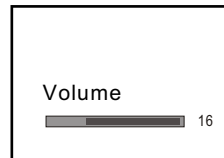

5) SCAN

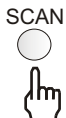

By Pressing this key, Programs will change automatically. Each program will be previewed for 2 seconds, and stop at original program. Skipped programs will not be previewed.

6) TV/AV Selection



You can select your video source by the [AV] key.

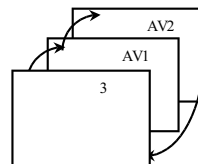

7) MUTE



By pressing this key, sound output will be muted.
Press MUTE key again, or Volume Up, and sound Volume will return.



8) Quick View



Program will quick back to the previous program being watched.

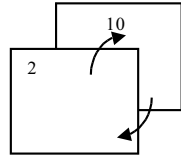

9) DISPLAY



• **TV / AV MODE**

This key will call the program No. On Screen Display.
Press again, to remove the program No On Screen Display.

• **Menu MODE**

Pressing the DISPLAY key, current menu will exit directly.

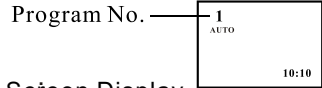

10) PICTURE EFFECT

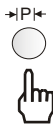

By repeatedly pressing this key, picture effects will change as follows:

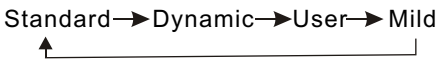

11) V-CHIP

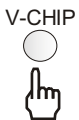

By pressing this key, the parental menu appears.

Parental	
	Lock Code -----
	Lock Off
	PG Rating ▶
	MPAA Rating: Off
	Can. english: Off
	Can. French: Off
	Change code ▶

12) CALENDAR

CALE



By pressing this key, CALENDAR will be appear.

Using [P+]/[P-] keys, to change the year.

Using [V+]/[V-] keys, to change the month.

2008 1						
SU	MO	TU	WE	TH	FR	ST
		1	2	3	4	5
6	7	8	9	10	11	12
13	14	15	16	17	18	19
20	21	22	23	24	25	26
27	28	29	30	31		

13) SLEEP

SLEEP



Repeatedly pressing this key, sleep timer will change as follows:



"0 → 15 → 30 → 45 → 60 → 75 → 90 → 105 → 120 → 135 → 150 → 165 → 180 → 195 → 210 → 225 → 240 → 0"

Tuning Procedure

- 1) Auto Search** Function:
Automatic Search and Memory (ASM)
Using the [MENU] key on the front or
the [MENU] key on the Remote for ASM.

- A. Press [MENU] key repeatedly to select
“INSTALLATION”
B. Press [P+]/[P-] keys, to select “Tuning
mode” .

Repeatedly pressing [V+]key, signal input model will change as follows:

Air → CATV/Cable

Air → CATV/Cable(STD) → CATV/Cable(HRC) → CATV/Cable(IRC)

and select input model.

※ This item is option.







- C. Press [P+]/[P-] keys, to select “Auto search”
D. Press [V+] key, to start ASM.

- 2) FINE TUNING** Function: Fine Tuning for current setting.

- A. Using [P+]/[P-] keys, to select “Channel” . Using [V+]/[V-] keys, to change
Program Number.
B. Using [P+]/[P-] keys, to select “Fine ture” .
C. Using [V+]/[V-] keys, to adjust for best tuning.

- 3) SKIP** Function: Use to “SKIP” Programs. After setting to “ON” , the
program will not be selected by program Up/Down keys.

- A. Using [P+]/[P-] keys, to select “Channel” . Using [V+]/[V-] keys, to change
Program Number.
B. Using [P+]/[P-] keys, to select “Skip” . Using [V+]/[V-] keys, to select “ON”
or “OFF” .

INSTALLATION		
	Tuning mode	Air
	Channel	6
	Color system	Auto
	Skip	On
	AFT	On
	Auto search	▶
	Fine ture	

VCHIP and CCD

1) SELECT VCHIP MODE

- A. Press [MENU] key repeatedly to select "FEATURES".
- B. Press [P+]/[P-] keys, to select "parental".
- C. Press [V+]/[V-] keys, to parental menu appears.

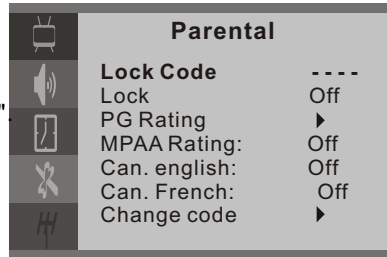

2) VCHIP Password

- A. Factory mode PIN is "0000", the common PIN is "4100".
- B. Input the correct PIN, then can set the next items, include "PG Rating", "MPAARating", "Can.english", "Can. French".
- C. "Lock" is general lock, only when this item is on, parental mode can be effective. When parental mode is effective, the screen is blue background and sound is mute.
- D. Using [P+]/[P-] keys, to move the cursor.
Using [V+]/[V-] keys, to select each item.

3) PG RATING

When you select " U.S. TV", using [P+]/[P-] keys, to move the cursor for up and down.
Using [V+]/[V-] keys, to move the cursor for right or left .
Using the [MENU] key, to preset view or block.

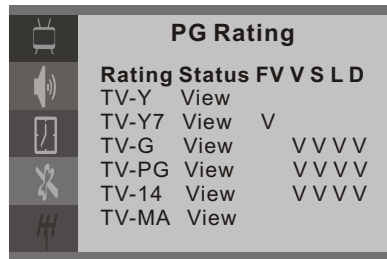

4) MPAA RATING

When you select " MPAA RATING", Using [V+]/[V-] keys, to changesetup.

5) CANADA ENGLISH AND CANADA FRENCH

When you select "Can.english" or "Canfrench" Using [V+]/[V-] keys, to change setup.

6) CHANGE PASSWORD

Select and enter "Change Code" menu,

- A. Input a new PIN.
- B. Input the PIN again to confirm.

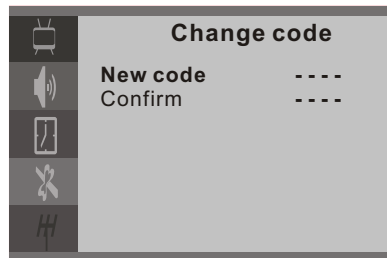

7) CCD

Select the program which is broadcasting the CCD you want to watch. Press [CCD] key on the remote control, "CCD On" appear on the screen and after it disappears, the information of CCD will display on the screen. By repeatedly pressing [CCD] key, CCD will change between ON and OFF.



Menu Operation

1) [MENU] key

Press [MENU] key continuously, to scroll through the MENU selection, as follows:



2) PICTURE MENU

- A. Select each function using [P+]/[P-] keys.
- B. Each value can be controlled by [V+]/[V-] keys.
- C. Repeat any functions if required.

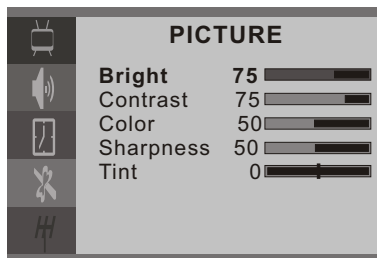

※The TINT will only appear when receiving the signals of NTSC system.

3) SOUND MENU

- A. Select each function using [P+]/[P-] keys.
- B. Each value can be controlled by [V+]/[V-] keys.
- C. Repeat any functions if required.

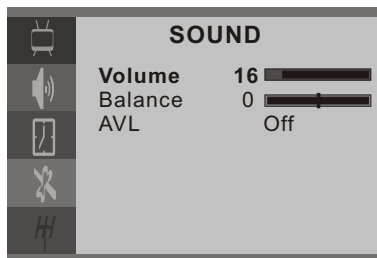

※Balance , AVL is option.

4) TIMER MENU Function: Time and Timer setting.

- A. Using [P+]/[P-] keys, to select "Timer", "Clock", "On time", "Off time" or "On channel"
- B. Using [P+]/[P-] keys, select "Timer". Using [V+]/[V-] keys, change Timer On or Off.
- C. For "Clock", "On time", "Off time" setting. Using [V+]/[V-] keys, select minutes or hours. Using [P+]/[P-] keys, set minutes or hours.
- D. For "On Channel" setting. Using [P+]/[P-] keys, select "On Channel". Using [V+]/[V-] keys, change On Channel number.

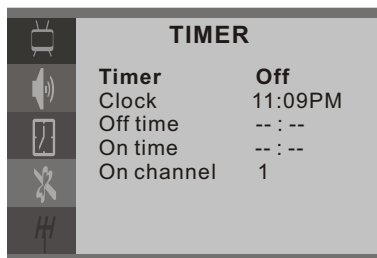

5) FEATURES MENU Function: other functions setting.

A. Using [P+]/[P-] keys, to select each item.
Using [V+]/[V-] keys, to change the value of each item.

FEATURES	
Language	English
Blue screen	On
Picture enhance	Off
CCD	On
CC mode	CC1
Parental	▶
Game	▶

B. Using [P+]/[P-] keys, to select "Language".
Using [V+]/[V-] keys, Language will change as follows:

English → Français → Español
→ Português

C. Using [P+]/[P-] keys, select the "Blue screen".
Using [V+]/[V-] keys, select "On" or "Off".

D. Using [P+]/[P-] keys, select the "Picture enhance".
Using [V+]/[V-] keys, select "On" or "Off".

E. Using [P+]/[P-] keys, to select "CCD".
Using [V+]/[V-] keys, to preset "ON" or "OFF".

F. Using [P+]/[P-] keys, to select the "C.C mode".
Using [V+]/[V-] keys, caption mode will change as follows.

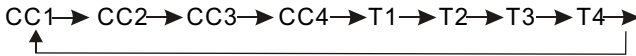

G. Using [P+]/[P-] keys, to select the "GAME".
Using [V+]/[V-] keys, to enter the game.

Battery Installation(Remote Control Unit)

- 1.Remove the battery cover.
- 2.insert the 2 UM-4 AAA 1.5V batteries making sure the polarity(+or -)of the batteries matches the polarity marks inside the unit.
- 3.Replace the battery cover.
Replace with new batteries when the TV set begins to show the following symptoms: operation is unsteady or erratic. Sometimes the TV set does not function with Remote control unit.

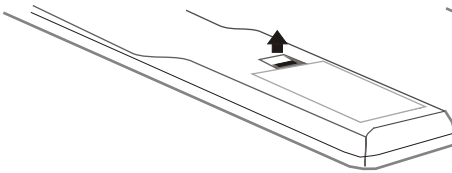

①

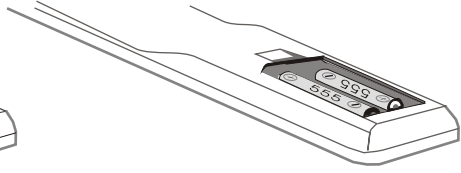

②

Remark:

- 1) Alkaline batteries recommended.
- 2) Remove batteries when they are exhausted or if the remote control is not to be used for a long time.

WARNING:

The battery(battery or batteries or battery pack)shall not be exposed to excessive heat such as sunshine,fire or the like.

The Causes of Interference

Incorporated in your TV receiver are the most up-to-date devices to eliminate interference. Local radiation however, can create disturbances which Visibly affect your picture. Proper installation, a good aerial are your best safeguards against these disturbances.

INTERFERENCE

Moving ripples across the screen are caused by nearby transmitting or receiving shortwave radio equipment.

DIATHERMY

Herringbone pattern and partial picture loss can result from the operation of diathermy equipment from a nearby doctors surgery or hospital.

SNOW

Weak TV signals from long distant stations result In an unsteady picture and give the effect of falling snow. An antenna adjustment or antenna amplifier may be needed.

GHOST

Multiple images caused by TV signals reflected back from surrounding buildings, hills, aircraft, etc. are minimized by correct aerial positioning.

CAR IGNITION

Nearby cars and electrical motors can cause small streaks across the picture or make the picture roll.

Service Tips

BEFORE CALLING FOR SERVICE, HAVE YOU CHECKED()THE FOLLOWING CHART ON SYMPTOMS AND SOLUTIONS?

Symptoms	Solution	Try different channel, if OK, probably station trouble	Check aerial connections on back of set	Check aerial for broken wires	Re-orient aerial(if indoor type)	Probably local interference, such as an appliance	Adjust fine tuning control	Adjust brightness control	Adjust contrast control	Check if station is broadcasting colour	Adjust colour control	Check if system switch is correct	Check if on/off switch is on	Check Batteries in Remote control
No picture, no sound		●	●	●			●					●	●	
Poor sound, picture OK		●			●	●	●					●		
Poor picture, sound OK		●	●	●	●	●	●	●				●		
Weak picture		●	●	●	●		●					●		
Blurred picture		●		●	●		●					●		
Double image		●	●	●	●		●							
Lines in picture		●		●	●	●	●							
Distorted picture		●		●	●	●	●					●		
Weak reception on some channels		●	●		●	●	●					●		
Horizontal bars				●	●	●								
Picture rolls vertically		●		●	●	●						●		
Poor colour		●	●	●	●	●	●	●	●		●	●		
No colour		●	●	●	●		●			●	●	●		
Misoperation of Remote control														●
No Remote control														●
On screen Display Control outside the screen											●			