

User Manual

ARvision

(with USB 2.0 Camera)



Subject to technical modifications

WARNING

Before using the ARvision HMD please read carefully these safety instructions.

Read this handbook and use the ARvision device in strict accordance in order to prevent any damage to your eye, other injury, loss of visual functions, property damage or death.

Children under the age of fifteen may not use this product.

We strongly advise you to get familiar with the ARvision device and its capabilities before you use it for the first time.

Table of Contents

Table of Contents	3
1 Safety instructions	4
1.1 Health concerns	4
1.2 General safety hints	5
1.3 Warning for electrical products	5
2 Content of the ARvision Kit	6
3 Description	7
3.1 Head Mounted Display HMD	7
3.2 Power unit	8
3.3 Charge unit	10
4 General Operating Instructions	12
4.1 Preparation	12
4.2 Connecting external video sources	15
4.3 Using ARvision as a Monitor.....	16
4.4 Using different Modes.....	17
4.5 USB-Camera / Software	20
4.6 AR setup	20
4.7 Adjusting the Interpupil Distance	22
5 Maintenance and Cleaning Instructions	23
6 Troubleshooting	24
7 Returning used electronic devices in EU countries	25
8 Technical Data	26
8.1 Head Mounted Display.....	26
8.2 Power unit	27

1 Safety instructions

1.1 Health concerns

➔ **WARNING:** Eye Disease, Eye Injury, and Glaucoma

If you have been diagnosed with or are susceptible to eye disease, eye injury, or glaucoma consult your doctor before use and do not use without your doctor's approval.

➔ **CAUTION:** Heart Disease, High Blood Pressure

If you have a history of heart disease or high blood pressure consult your doctor before use and do not use without his approval.

➔ **CAUTION:** Seizures

If you have a history of temporary spasm, unconsciousness, or epileptic seizures from light stimulation, consult your doctor before use and do not use without his approval.

If any of the following symptoms occur, if using ARvision, stop using immediately and rest:

- eye fatigue or irritation,
- headaches or dizziness,
- aches and pain in the neck or shoulders,
- double vision,
- nausea or motion sickness,
- inability to focus on the displays.

Misuse or overuse of this product may result in eye damage, or loss of visual functions.

1.2 General safety hints

- ➔ Avoid getting the cable entangled around your neck, body or arms. Use the belt pouch for the power unit and wear the cable close to your body.
- ➔ To ensure that the device does not fall off during use, always use the elastic strap, and have it tightened with an adequate tension.

1.3 Warning for electrical products

- ➔ To avoid any risk of electrocution, do not bring any part of the ARvision in contact with water when the power unit is connected to an AC outlet (e.g. when recharging batteries, using an external TV-, DVD-, Video- or PC-source).
- ➔ Avoid using and storing the ARvision at wet, humid, dusty and smoky surroundings and extreme temperatures.
- ➔ Do not use ARvision at temperatures below -10°C and above +40°C. Avoid dropping or mechanical shock, as frame and displays may be deformed.
- ➔ Always switch off and unplug the ARvision when it will not be used.
- ➔ In case of damage contact your retailer. There are no user serviceable parts. Only qualified service personnel should perform any service required on this product.

2 Content of the ARvision Kit

The ARvision kit contains the following elements. Please check that all of these are included. If any item is not supplied contact your ARvision dealer.

ARvision HMD with connecting cable (1),
Power unit (2), Battery (3),
AC/DC transformer with power cord (4), Charge unit (5),
Case (6), Cleaning cloth (7),
USB-Cable (8), USB-Driver-CD(9)

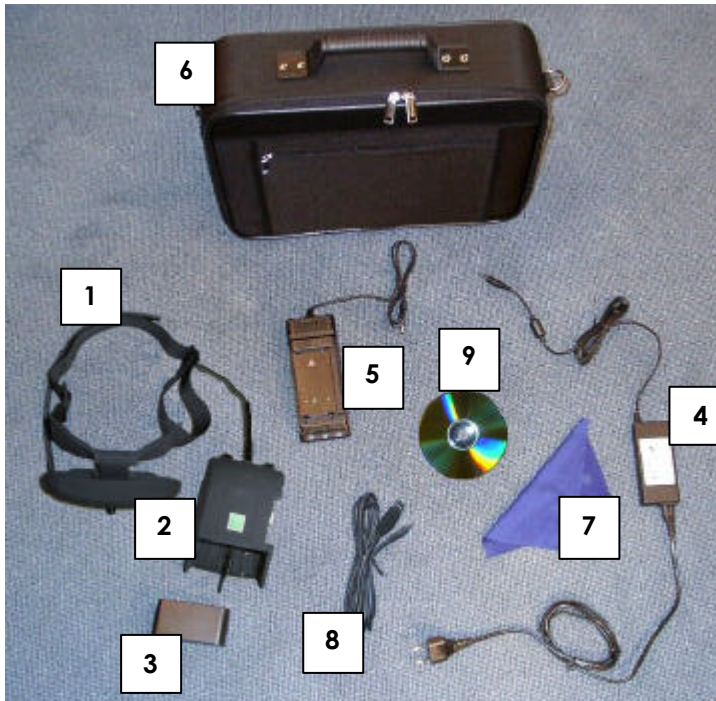

3 Description

3.1 Head Mounted Display HMD

The HMD contains two **microdisplays** (2) to show the images. The **cable** (1) is permanently attached to the HMD and to the pocket element (power unit). The built-in color camera (3) provides the video signal to the power unit for output to a PC. Without a PC or external video source connected to the power unit there is no image visible inside the HMD.

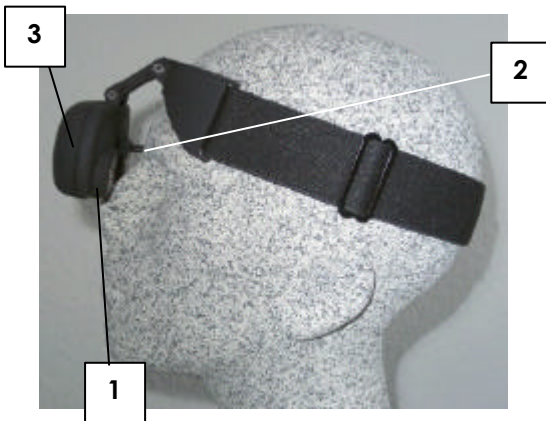

3.2 Power unit

The plastic casing contains the following elements:

- (1) HMD cable permanently attached
- (2) Plug connection for PC (USB and VGA)
- (3) Push button for power (illuminated)
- (4) Push button for headlight
- (5) Connector for power supply (under the battery)
- (6) Knob for manual adjustment of brightness
- (7) Knob with triple function: for manual adjustment of contrast, for electronic zoom or phase, depending upon the mode (see further).

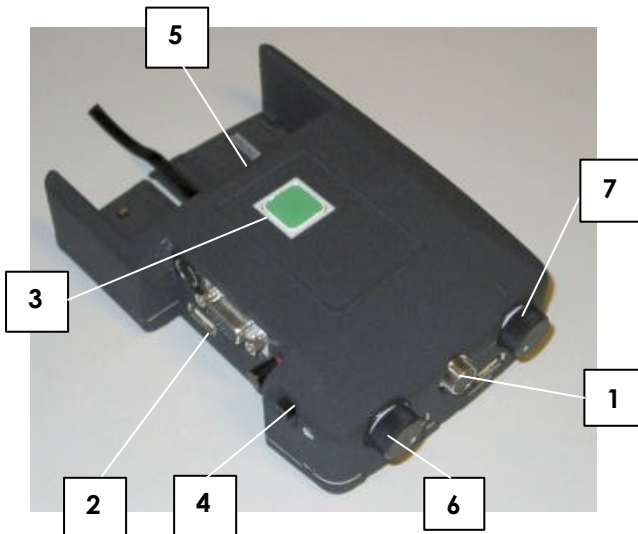

The **push button** (3) on the top of the power unit is used to switch the ARvision on and off. When the device is switched on, a light underneath the button lights up. When removing the battery, an **input connector** (5) for an external power supply becomes visible. (see further)

The **knob on the left** (7, page 8) of the cable enables manual adjustment of brightness. The **knob on the right** (6, page 8) of the plug connection has a triple function, it enables manual adjustment of contrast, of the zoom function or phase adjustment in VGA-mode.

The **power unit** also contains:

- (1) Push button for white head light
- (2) Control lamp for headlight
- (3) Socket connector for external video signal
- (4) Socket connector for other external image sources (SVGA from computer).
- (5) Button for selecting the input signal mode
- (6) Control lamps
- (7) Socket connector for USB camera signal (output)

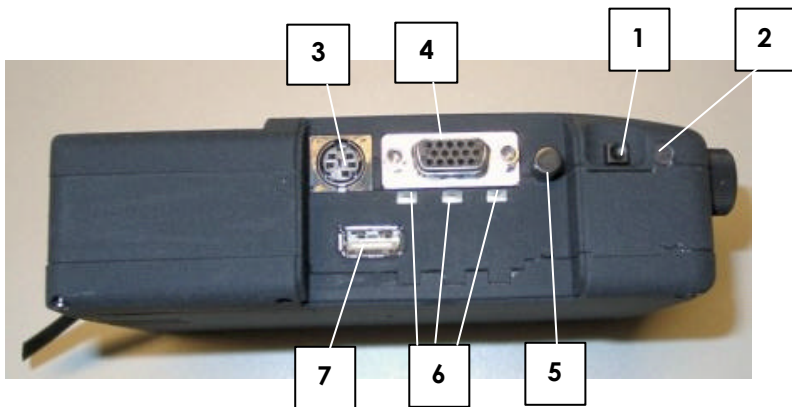

3.3 Charge unit

ARvision includes a removable Ni-MH rechargeable battery (2) and a power supply unit (1) for generating different voltages, which also includes a charging circuit for a mains adapter (3). It takes approx. 50 min to charge the battery from empty to full if you use the mains adapter supplied with the system. During charging process it is possible to use ARvision parallel.

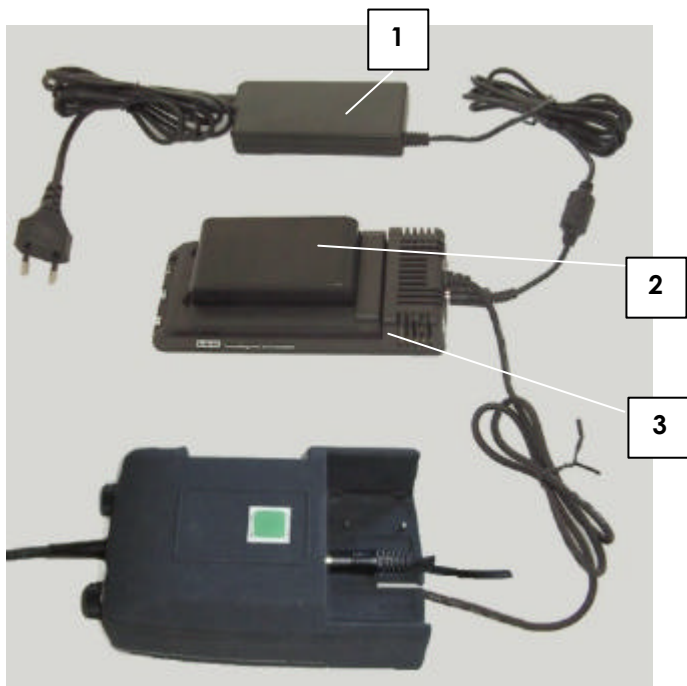

The charge unit has control lights.

- When loading the unit with a battery to be charged, the **red light** will turn **on**, but only for a while. It should turn off after a certain time (not more than a minute), otherwise it indicates a defect.
- If voltage input is incorrect or unstable, the **red light** lights up.
- When charging starts the **green light** will be **on**.
- When charging is completed, the **green light** will begin to **flash**.
- The **yellow light** is in relation with the temperature control. If it turns on, the maximum temperature allowed has been reached, and loading is temporarily interrupted.

You may leave the battery in the charge unit without any danger, until charging is complete (= green light flashing).

4 General Operating Instructions

4.1 Preparation

Unpacking the Device

- ➔ Please unpack the devices and compare with the list under paragraph 2 on page 6 to check that all parts are complete. Please contact your dealer if any parts are missing.

Checking, charging and changing the Battery

Before you use the HMD for the first time, please check whether the battery is fully charged:

- ➔ Remove the battery from the power unit. To do so, pull the tape down carefully with one hand and push the battery out of the casing with the thumb of your other hand. For that process do not lay down the power unit on the table.



- ➔ Place the battery in the charger so that the brass-coloured contacts of the battery and charger match. Press the battery lightly until you feel it locks into place. The green control lamp on the front of the charger lights up. When the green control lamp begins to flash, the charging process is completed (see paragraph 3.3 on page 10).
- ➔ Replace the battery in the power unit. To begin with, this may require some practice. Please make sure that the contacts of the battery and the power unit match. Holding the battery flat, push it into the power unit as far as the mark. Press down the battery lightly with your thumb and at the same time continue pushing it completely into the power unit until it locks into place. For that process do not lay down the power unit on the table.



Using the HMD with external power supply

It is possible to have the power supply coming from an external source. One such source is the AC/DC transformer that comes with the charge unit. Its output is 12 V DC, available at the special plug. This plug (see also **Fehler! Verweisquelle konnte nicht gefunden werden.**) page **Fehler! Textmarke nicht definiert.**) fits in the connector at the battery location of the power unit (visible when the battery is removed).



4.2 Connecting external video sources

Choose one of the video adapter cables supplied with the system and plug into the socket connector on the right hand side. Turn on the video source and select the appropriate mode by pushing the select button (1). For further details about different modes see 4.4 page 17. If video-in function is used there is no output of camera signal in the same time.

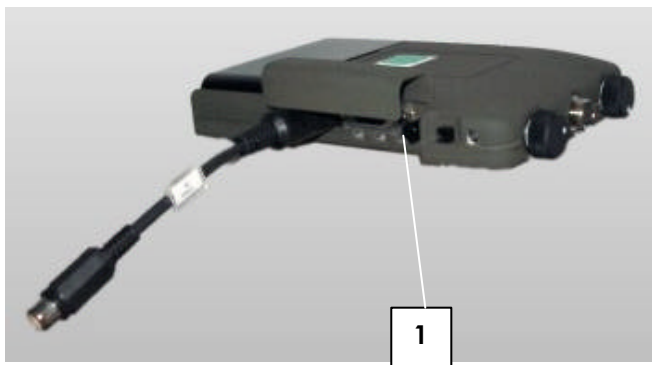

4.3 Using ARvision as a Monitor

Putting on the HMD

- Put on the ARvision HMD. Place the headband around the back of your head and pull it just tight enough to make it fit safely and comfortably.
- On the displays inside the HMD, you can now see the pictures of your video source.
- Wearing the HMD you will see your surroundings only constricted. For this reason, please, move only carefully or not at all.
- A static image can burn into the microdisplays after an extended period of time !

Adjusting Brightness and Contrast

- Adjust **brightness** (1) and **contrast** (2) with the knobs beside the cable. Turn the knobs until the image quality you find best

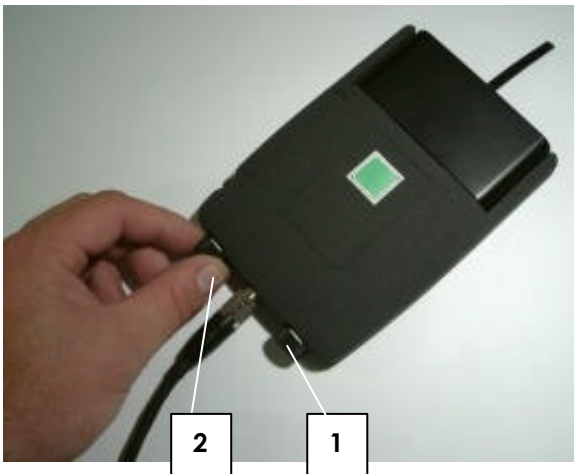

4.4 Using different Modes

The electronics of your ARvision device allows different functions.

The selection of those functions is governed by the **push-button switch (PBS)** (1) that is located on the right hand side of the power unit.



- The **basic mode** is the one where the ARvision displays the images as captured by the VGA-adapter. You can apply a PC VGA signal 800x600@ 60Hz, 75Hz, 85Hz or 100Hz. With the contrast button (see "Power unit" page 8) you can adjust the phase of VGA-signal. The **right hand side green LED** (page 17, (4)) will be lit on. When no VGA signal is connected, this LED will be blinking.

- When pushing the push-button switch **PBS** (page 17, (1)) **once**: no function
- Pushing the **PBS** a **second time**: no function
- Pushing the **PBS** (page 17, (1)) a **third time**, discerns between "composite video" or "S-video", and it will equally recognise automatically whether it concerns a NTSC or PAL signal. The **middle green LED** (page 17, (3)) will be lit on to remind you of this mode. When no video signal is connected, this LED will be blinking. In this mode the two knobs beside the cable connection control the brightness and the contrast.
- Pushing the **PBS** (page 17, (1)) a **fourth time**, the electronic zoom is activated to magnify the external "composite video" or "S-video" signal. It can be noticed by the green frame that appears around the display in the HMD and the **left** and **middle green LED** ((2)+(3) page 17) of power unit will be on. The adjustment of the electronic zoom is set by using the contrast knob on the right hand side of the cable connection.
- If the PBS is pushed a **fifth time**, the device goes back into basic mode.

Pushing PBS (1) page 17	3 green LEDs (2-4) page 17	Description
0x	[] [] [x]	standard mode = external VGA signal (after turning on device)
	[] [] [b]	no external VGA signal detected
1x	[] [x] []	external video/S-video signal
	[] [b] []	no external video signal detected
2x	[x] [x] []	external video signal zoomed, green frame around image
	[b] [b] []	no external video signal detected
3x	[] [] [x]	back to standard mode

[] = LED off

[x] = LED lit

[b] = LED blinking

4.5 USB-Camera / Software

Connect the power unit with the PC using the USB-cable (1) and power on the device. Microsoft Windows® will recognize new hardware automatic. Install the software from CD-ROM according instructions. To avoid damage (and to prevent aging) please unplug the USB-cable between powerunit and PC during lightning storm and when unused for long periods of time.

4.6 AR setup

To use the device with AR function (augmented reality) the camera signal must be sent to a computer using a standard USB 2.0 cable "male A to male A" (plug into "Video-out" (1)). Then the overlaid video signal from the PC can be directed into the power unit using a VGA-cable (2). The PC-resolution must be set to 800x600@60Hz.

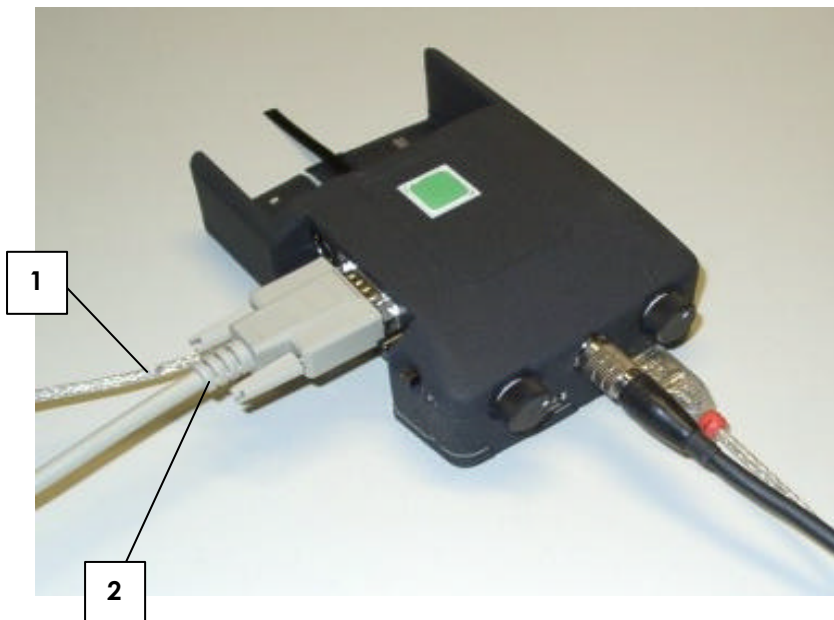

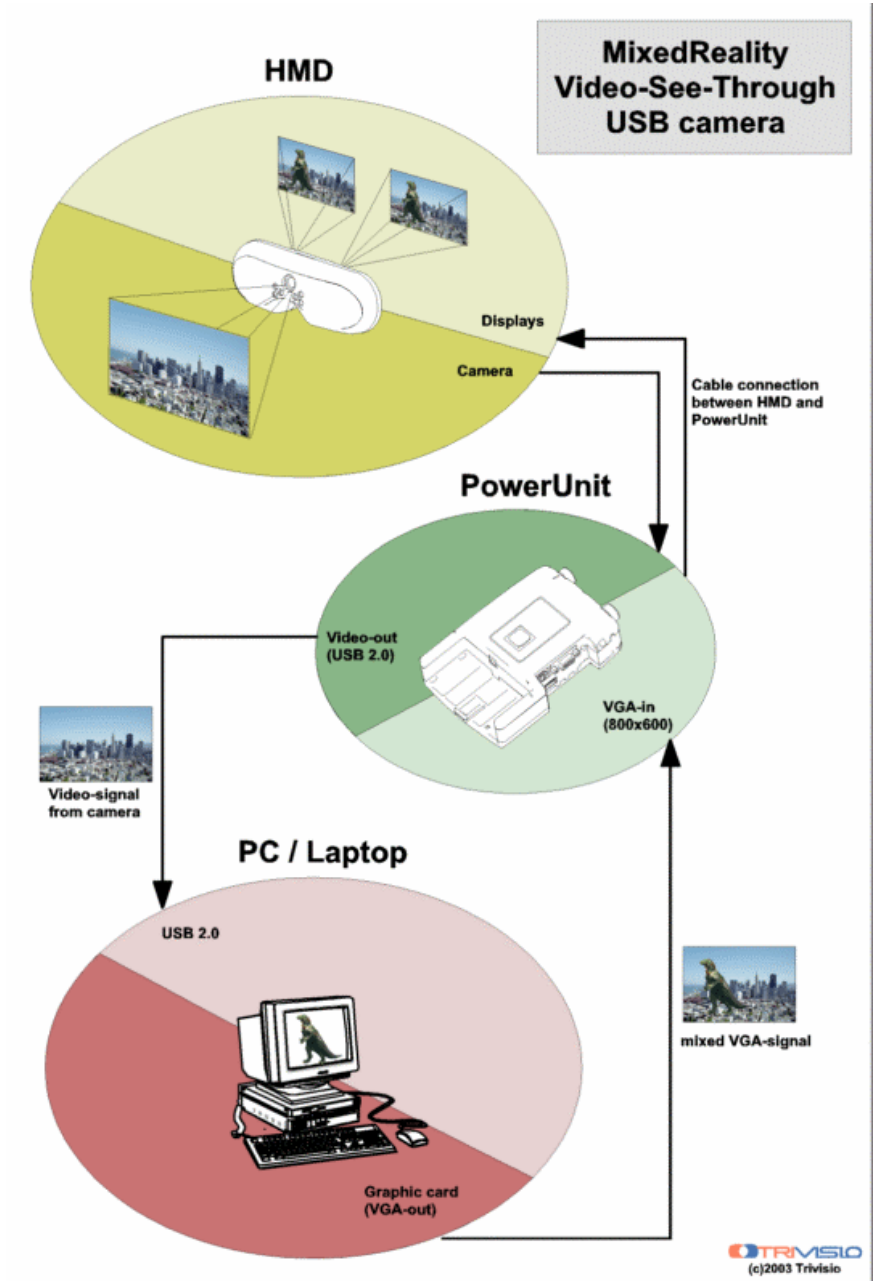

4.7 Adjusting the Interpupil Distance

To optimize the position of the two displays, so that both images are seen as a single visual field, carefully move the oculars into the right position.

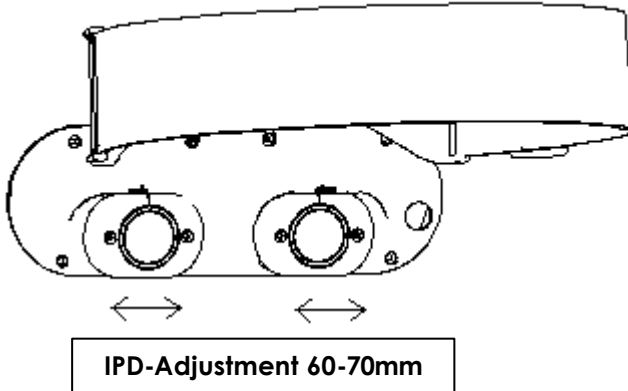

5 Maintenance and Cleaning Instructions

To clean the HMD or goggles and control unit, use a damp cloth. A light rinsing agent may be added to the water. Do not use any detergents.

To clean the optical parts of the HMD/goggles (oculars, camera lens, white LEDs) use a dry, clean cloth. A cleaning cloth for this purpose is provided with the ARvision kit.

In case of damage contact your retailer. There are no user serviceable parts. Only qualified service personnel should perform any service required on this product.

6 Troubleshooting

Problem	Cause	Remedy
Only dark, or only white image	Incorrect brightness. Brightness knob and/or contrast knob are on max. or min. position.	Adjust by using brightness knob and/or contrast knob
Completely white image	After having used electronic zoom, contrast knob is "deregulated", i.e. at an extreme	re-adjust contrast
No image	In basic mode and no VGA signal applied	connect a video source (SVGA)
No image	Appliance switched off	switch on ARvision with main push button
No image	Video cable connected, but wrong video source selected	either connect a video source and select compatible mode for this video signal with PBS

All other problems should be performed by a trained and authorised service provider !

7 Returning used electronic devices in EU countries

	<p>This HMD and accessories shall not be treated as household waste. The separate collection is a condition for reuse, recycling and utilisation of used electronic devices, which ensures the protection of resources. To comply with german ElektroG (Rücknahme und Entsorgung von Elektro- und Elektronikaltgeräten) and european WEEE (Waste Electrical and Electronic Equipment) electronic used devices from private households can be returned free of charge. For details please contact your local distributor or directly Trivisio Prototyping GmbH (www.trivisio.com).</p>
-----------------------------------------------------------------------------------	-----------------------------------------------------------------------------------------------------------------------------------------------------------------------------------------------------------------------------------------------------------------------------------------------------------------------------------------------------------------------------------------------------------------------------------------------------------------------------------------------------------------------------------------------------------------------------------------------------------------------------

8 Technical Data

8.1 Head Mounted Display

Camera.....	640x480 pixels color 8bit, 48 fps, 15 Mbit/sec 1/3"CMOS
Focus	manually adjustable
Iris.....	fixed
Camera lens.....	52° (changeable)
Display	2x SVGA microdisplays 480,000 pixels colour equals 1,440,000 pixels
Field of view	approx. 40° diagonal
Eye distance	60-70 mm adjustable
Operating temperature.....	-10°C to +40°C
Weight	150g
Dimensions (W/H/D)	155mm/50mm/55mm

8.2 Power unit

Brightness.....	manually adjustable
Kontrast	manually adjustable
Digital magnifier.....	built-in electronic zoom 8x
Mode switch.....	5 modes
Basic mode.....	SVGA (from PC) 800 x 600@ 60/75/85/100Hz
Second mode.....	Composite video, S-video in NTSC or PAL
Third mode	external video zoomed
Weight	approx. 380 g (incl. battery)
Dimensions (W/H/D).....	105mm/155mm/25mm
Operating temperature.....	-10°C to +40°C
Battery	changeable + rechargeable Ni-MH 6V/2, 1Ah
Charging time.....	approx. 50 min, with enclosed power supply
Operating time.....	approximately based on standard batteries: 2 h (external video source) 4 h (external SVGA source)