

Copyright © 2010 GIGABYTE TECHNOLOGY CO., LTD.
All Rights Reserved

GIGABYTE E1500 Series Notebooks User's Manual

Date Issued: 2010/10

This manual takes you, step by step, through setting up and using your new Notebook PC. Information in this manual has been carefully checked for accuracy and is subject to change without prior notice.

No part or parts of this manual may be reproduced, stored in a retrieval system, or transmitted, in any form or by any means, electronic, mechanical, by photocopy, recording, or otherwise, without prior written consent.

Trademarks

Product names used herein are for identification purposes only and may be the trademarks of their respective companies.

Microsoft® , MS-DOS, Windows® , and Windows® Sound System are trademarks of the Microsoft Corporation.

Intel® & Core™ . are registered trademarks of Intel Corporation.

Sound Blaster & Sound Blaster Pro are trademarks of Creative Technology.

All other brands or product names mentioned in this manual are trademarks or registered trademarks of their respective companies.

General Safety Precautions

In order to ensure your safety and the safety of you notebook, we ask that your carefully follow these safety precautions.



CAUTION: Using your notebook for long periods of time, with the base resting directly on exposed skin, can cause injury, burns or discomfort from the heat buildup that is generated from the base of your portable computer.

- After removing the notebook from the box, please ensure that all packaging materials are kept out of the reach of small children as they can cause a potential choking hazard. The packaging materials should be safely stored away in the event that it may be used again for safe transportation of the notebook.
- Ensure that the AC Adapter and power cable are placed in a safe area where it cannot be tripped over or stepped on. The AC Adapter should be situated in a well ventilated area and should have nothing resting on or covering it.
- Before turning on the notebook, ensure that it is placed on a level surface with at least 10 cm of clearance around the air vents, which will aid in proper cooling.
- Do not obstruct the air vents of the notebook and do not insert any foreign objects into this space. Doing this may cause a short circuit or may cause the CPU fan to malfunction, resulting in the risk of a fire or electric shock. This may eventually render permanent damage to the notebook.
- Do not press or touch the display panel.
- Only use the AC Adapter that is provided with the notebook or

that which is recommended by the manufacturer. Using non-recommended or non-approved parts may cause damage or increase the risk of a fire or explosion. In the event that another AC Adapter is required, advice should be sought from a GIGABYTE service agent, in order to make sure that the correct part is recommended.

- Please follow the battery installation guidelines. Incorrect installation of batteries may increase the risk of a fire or explosion.
- Only replace old batteries with the same or an alternative compatible battery that is recommended by GIGABYTE or an authorized GIGABYTE Service Centre.
- Before connecting the notebook to the power outlet, make sure that the voltage rating of the AC Adapter is compatible with the power specification in the country where you are located. A detailed list of the power specification for different countries can be found on page 21.
- When using an extension cord, please make sure that the total sum of ampere ratings for all connected devices does not exceed the total ampere capacity for the circuit.
- Before removing the battery from the notebook, make sure firstly that the notebook is switched off and secondly that the AC Adapter is disconnected from the electrical wall socket. Once this is done, it would be safe to remove the battery.



Do not carry the notebook battery, loose, in your handbag, backpack or pocket where loose metal objects (money, keys, chains, pens, etc) may be present. The metal objects can short circuit the terminals of the battery resulting in overheating that could cause a fire hazard. In the event that you need to transport the battery separately from the notebook, please place it inside an anti-static bag.

- Discard old worn out batteries according to the instructions on Page VI. Never throw batteries into a fire as this can cause an explosion.
- Never attempt to repair or service the notebook yourself. Please refer all repairs and servicing to qualified service personnel at a GIGABYTE Authorized Service Centre.

Travel Tips

Although notebooks are designed to be as robust as possible to cater for a mobile lifestyle, extreme care and caution should be taken when travelling. When travelling by land, sea or air, every precaution should be taken to make sure that the notebook is well secured when it is not in use.

- The most essential accessory you should have when travelling is a good carry case for your notebook. The case should be well padded to protect your notebook from drops and bumps, etc and should be big enough to hold the size of notebook.
- Make sure there is enough room to carry your AC Adapter and spare battery etc. Only carry the necessary items in your carry case, as the weight can become tedious especially when walking long distances or waiting in long queue's.
- When travelling by air, never book your notebook in with checked baggage. Always declare it as hand baggage so that you can carry it into the airplane cabin with you. Most airlines allow two pieces of hand baggage with one of them being a bag or carry case with a portable notebook. Please consult your local airline for more details.
- When placing your notebook on an X-Ray, make sure that you keep a close eye on it when it is one the conveyor belt. Hold on to your

notebook until the last minute before placing it on the conveyor. In some airports it could be stolen while you are stuck in a queue waiting to pass through the metal detector.

- Notebooks and hard drives can pass through X-Ray machines but never allow these to pass through a metal detector. This can cause data loss to the hard drive.
- Never place your notebook in the overhead storage compartment as this can make it susceptible to damage caused by turbulence that may be experienced during the flight or in other case theft. You can store your notebook under your seat, where it is always in sight.
- You should take every precaution to protect your notebook from dust, dirt, liquid spillage, food droppings, extreme weather conditions and direct exposure to sunlight.
- When travelling between different climates, from one extreme to another, condensation may occur inside the notebook. If this does happen, please allow sufficient time for the moisture to evaporate completely, before attempting to switch on.
- When travelling from extremely colder to extremely warmer climates in a short space of time, and vice versa, please allow the notebook some time to adapt to the change in environment.

Usage Tips

- When unplugging the power connector from the notebook, please hold and pull on the connector or the strain relief loop to disconnect. Do not pull the power cord itself as this can cause damage to the cable or the notebook.
- In the event of an electrical storm, please disconnect the notebook from the power source and unplug any network or telephone cables that may be connected to the notebook.

- Do not use the notebook near water sources, like bathtubs, washing basins, kitchen or laundry sinks or swimming pools. Liquid that can spill onto the notebook by accident can cause electric shock to you and damage to the notebook.

Cleaning Tips

When cleaning the notebook, please make sure that the notebook is switched off and disconnected from the power source and that the battery is removed.

Notebook Cover:

Use a microfiber or lint free soft cotton cloth and kitchen detergent (mix 5 parts water to 1 part detergent).

- Wet the cloth and wring out all excess liquid and wipe the surfaces clean.
- Take extra care to make sure that the cloth is damp and not very wet, especially when cleaning around the air vents and other openings as too much liquid in the cloth could drip onto the external components causing damage to the notebook.
- Do not clean the keyboard with this liquid.

Keyboard:

- It is advisable to use a can of compressed air to clean debris that maybe caught underneath the keys.
- Isopropyl alcohol can be used to clean the keys by dipping a lint-free soft cloth into it, wringing out the excess liquid and wiping the keys.
- Allow to dry for at least 5 minutes.

LCD:

- It is best to use a microfiber cloth to clean the surface of the LCD.
- If there are any marks or stains present, it would be wise to use commercially available LCD cleaning kit. When using a commercially available LCD cleaning kit, never spray the liquid directly onto the screen. You must spray it onto the cleaning cloth and then wipe the screen clean.
- If this is not available then you can mix 50% isopropyl alcohol and 50% distilled water to clean the surface of the LCD screen.
- Dip the lint free soft cotton cloth into the solution, wringing out excess liquid.
- The cloth must be damp but not dripping with liquid.
- Take care not to let any excess liquid drip into the notebook.
- Start from the top of the LCD surface and wipe from side to side.
- Continue with this until the entire LCD surface has been cleaned.
- Wipe the display with a clean, dry lint free soft cotton or microfiber cloth.
- Wait for the LCD surface to dry completely and then close the lid.



Be careful when using Isopropyl Alcohol as this is a flammable liquid. Please keep away from children, naked flames or a notebook that is switched on.

Warranty Guidelines

All warranty repairs and service must be carried out by a GIGABYTE Authorized Repair Centre.

GIGABYTE Limited Warranty

GIGABYTE warrants, that the GIGABYTE branded Notebook/Netbook is free of any defects in materials and workmanship under normal use during the warranty period.

- All GIGABYTE supplied AC adapters and batteries carry a 1 year limited warranty.
 - The warranty is effective from date of purchase.
 - If proof of purchase cannot be shown, then the warranty will be determined based on the date of manufacture.
 - The limited warranty is only valid for GIGABYTE branded or supplied hardware.
 - In the event that a defect arises in materials or workmanship and proof is shown of this defect, GIGABYTE will, through its authorized service provider or partner, repair the product at no extra charge, using new or refurbished replacement parts in order to fulfill the warranty obligations.
 - If, during the warranty period, GIGABYTE or its service provider is unable to repair the product, the product will be replaced with a comparable product that is new or refurbished.
- Software, including the operating system and applications supplied with the product. This also includes third party software that may be installed after purchase.
 - Third party hardware, products and accessories not supplied by GIGABYTE. This also includes third party hardware that may be bundled with the notebook or netbook.
 - Products with missing or defaced labels and/or serial numbers
 - Products damaged by environmental factors, which include oxidation
 - Products damaged by natural disasters or acts of God.
 - Physical Damages which include, but not limited to, the following:
 - ▶ Unauthorized modifications, repairs or servicing
 - ▶ Misuse, abuse, neglect or failure to follow instructions in the user manual.
 - ▶ Improper assembly
 - ▶ Damages caused by transport due to improper packaging or mishandling by the courier company unless transport is part of the warranty conditions in certain countries.
 - ▶ Electric damage resulting from faulty or failed electric power or power surges.
 - ▶ Damaged or cracked components
 - ▶ Liquid damage

Warranty Limitations

The GIGABYTE Limited Warranty does not cover the following...

Regulatory Notices

Federal Communications Commission Notice

This equipment has been tested and found to comply with the limits for a Class B digital service, pursuant to Part 15 of the FCC rules. These limits are designed to provide reasonable protection against harmful interference in a residential installation.

Any changes or modifications made to this equipment may void the user's authority to operate this equipment. This equipment generates, uses, and can radiate radio frequency energy. If not installed and used in accordance with the instructions, may cause harmful interference to radio communications. However, there is no guarantee that interference will not occur in a particular installation. If this equipment does cause harmful interference to radio or television reception, which can be determined by turning the equipment off and on, the user is encouraged to try to correct the interference by one or more of the following measures:

- Reorient or relocate the receiving antenna.
- Increase the separation between the equipment and receiver.
- Connect the equipment into an outlet on a circuit different from that to which the receiver is connected.
- Consult the dealer or an experienced radio/TV technician for help.
- All external cables connecting to this basic unit must be shielded. For cables connecting to PCMCIA cards, see the option manual or installation instructions.

RF Exposure

This equipment must be installed and operated in accordance with provided instructions and must not be co-located or operating in conjunction with any other antenna or transmitter. End-users and installers must be provided with antenna installation instructions and transmitter operating conditions for satisfying RF exposure compliance.

CE Notice (European Union)

This symbol  indicates this Booktop E1500 notebook complies with the EMC Directive and the European Union's Low Voltage Directive. This symbol also indicates that E1500 meets the following technical standards:

- EN 55022 — “Limitations and Methods of Measurement for the Radio Interferences of Information Technology Equipment.”
- EN 55024 — “Information technology equipment - Immunity characteristics - Limits and methods of measurement.”
- EN 61000-3-2 — “Electromagnetic compatibility (EMC) - Chapter 3: Limits - Section 2: Limits on the harmonic current emissions (Equipment input current up to and including 16 A per phase).”
- EN 61000-3-3 — “Electromagnetic compatibility (EMC) - Chapter 3: Limits - Section 3: Limits on the voltage fluctuations and flicker in low-voltage power supply systems for equipment with rated current up to and including 16 A.”



NOTE: EN 55022 emissions requirements provide for two classifications

- Class A governs commercial use
- Class B is governs residential use

For CB:

- Only use batteries designed for this computer. The wrong battery type may explode, leak or damage the computer
- Do not remove any batteries from the computer while it is powered on
- Do not continue to use a battery that has been dropped, or that appears damaged (e.g. bent or twisted) in any way. Even if the computer continues to work with a damaged battery in place, it may cause circuit damage, which may possibly result in fire.
- Recharge the batteries using the notebook's system. Incorrect recharging may make the battery explode.
- Do not try to repair a battery pack. Refer any battery pack repair or replacement to your service representative or qualified service personnel.
- Keep children away from, and promptly dispose of a damaged battery. Always dispose of batteries carefully. Batteries may explode or leak if exposed to fire, or improperly handled or discarded.
- Keep the battery away from metal appliances.
- Affix tape to the battery contacts before disposing of the battery.
- Do not touch the battery contacts with your hands or metal objects.

Battery Disposal & Caution

The product that you have purchased contains a rechargeable battery. The battery is recyclable. At the end of its useful life, under various state and local laws. It may be illegal to dispose of this battery into the municipal waste stream. Check with your local solid waste officials for details in your area for recycling options or proper disposal.

Danger of explosion if battery is incorrectly replaced. Replace only with the same or equivalent type recommended by the manufacturer. Discard used battery according to the manufacturer's instructions.

Replaceable Batteries

If any equipment is provided with a replaceable battery, and if replacement by an incorrect type could result in an explosion (for example, with some lithium batteries), the following applies:

- if the battery is placed in an operator access area, there shall be a marking close to the battery or a statement in both the operating and the servicing instructions;
- if the battery is placed elsewhere in the equipment, there shall be a marking close to the battery or a statement in the servicing instructions.

This marking or statement shall include the following or similar text:

CAUTION
RISK OF EXPLOSION IF BATTERY IS REPLACED
WITH AN INCOMPATIBLE BATTERY TYPE.
DISPOSE OF USED BATTERIES
ACCORDING TO THE INSTRUCTIONS





Introduction

Congratulations and thank you for purchasing the GIGABYTE notebook computer. This portable notebook computer provides excellent multimedia functionality and is designed to provide you reliable, no fuss computing.

This manual will explain to you, step by step, how to setup and begin using your E1500. It provides basic configuring, operation, care and troubleshooting guidelines.

Content

General Safety Precautions.....	I
Warranty Guidelines.....	IV
Regulatory Notices & Certifications.....	V
Introduction.....	VIII

Chapter 1 Before You Start

1.1 Make Sure You Have Everything.....	2
1.2 Familiarize Yourself with the Computer.....	2
1.3 Top View.....	3
1.4 Left View.....	4
1.5 Right View.....	4
1.6 Front View & Bottom View.....	6

Chapter 2 Getting Started

2.1 Power Sources.....	8
2.2 Recharging the Battery.....	9
2.3 Starting Your Notebook.....	10
2.4 Status Indicators.....	11
2.5 Using Function Keys.....	12
2.6 Using the Touch Pad.....	13

Chapter 3 GIGABYTE Smart Recovery

3.1 GIGABYTE Smart Recovery.....	16
----------------------------------	----

Chapter 4 Troubleshooting

4.1 Identifying the Problem.....	18
4.2 GIGABYTE Service Information.....	18

Appendix

E1500 Specifications.....	20
International Country Voltage.....	22
Plug Type.....	26



Chapter 1 Before You Start

This chapter provides basic information to help you get started and to use the E1500 notebook.

Some of the features described herein may not function properly or at all unless used in conjunction with the pre-installed operating system. Any change to the operating system may cause improper function.

1.1 Make Sure You Have Everything

When you receive your notebook PC, unpack it carefully and check to make sure you have all the items listed below. For a pre-configured model you should have the following:

- GIGABYTE Notebook Computer
- Lithium-Ion Battery
- AC Adapter with Power Cord
- Driver Disc
- Quick Start Guide

Once you have checked and confirmed that your notebook system is complete, read through the following pages to learn about all of your notebook components.



NOTE: Depending on the model you purchased, the actual appearance of your notebook may vary from that shown in this manual. These images are for illustration purposes.

1.2 Familiarize Yourself with the Computer

Opening The Display Panel

To open the display panel, simply lift the lid up. Use your one hand to hold the machine and use the other to open the display panel. When closing the lid, be sure not to slam it closed.

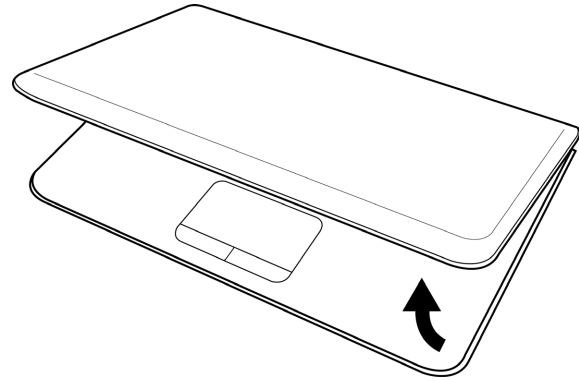

1.3 Top View

The following is an overview of the top of the notebook.

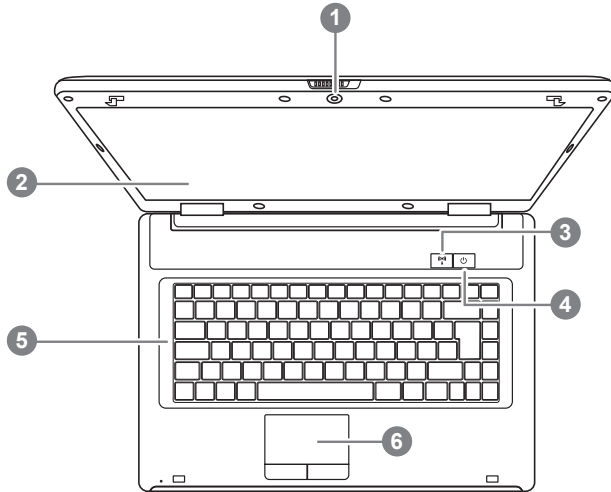

NO.	Item	Function
1	Webcam	The built-in webcam is housed here. The resolution depends on the configuration purchased. The cam is perfect for online chat and video streaming.
2	LCD Display	The display type and size depends on the model of notebook purchased. The supported resolution will also depend on the display type and size.
3	WLAN Button	The WLAN Button is to switch the Wireless LAN Function On or Off on the E1500.
4	Power Button	The power button is used to switch the notebook on and off, and for emergency shutdown or restart.
5	Keyboard	A full-size keyboard with dedicated Windows keys.
6	TouchPad	This is the pointer device controller for the system and mimics mouse movement on the screen. It has the standard Left/Right button arrangement.

1.4 Left View

The following is a brief description of the left side of the notebook.

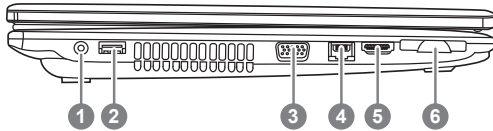

NO.	Item	Function
1	DC-in Jack	This port is used to connect the notebooks external AC Adaptor when charging or continuous power is needed.
2	USB Port	These ports are used for connecting external USB Peripherals and Storage to the Notebook. Devices such as Printers, Keyboards, Mice and Drives are supported and the ports are Plug And Play.
3	External Monitor (VGA) Port	This port is used to connect an external analog vga display to the notebook for output to a larger screen or projector.
4	LAN (RJ-45) Port	These ports are used to connect a standard RJ-45 LAN Cable for networking or RJ-11 Modem Cable for dial-up internet access.
5	HDMI Port	The HDMI port allows outputting a video signal in full High Definition to an HD compatible display as well as na HD sound signal.
6	Express Card Slot	The Express Card Slot allows you to install one Type-II Express Card Slot.

1.5 Right View

The following is a brief description of the right side of the notebook.

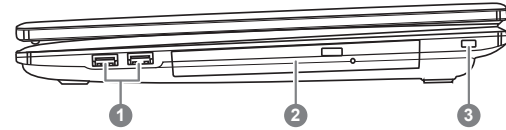

NO.	Item	Function
1	USB Port	These ports are used for connecting external USB Peripherals and Storage to the Notebook. Devices such as Printers, Keyboards, Mice and Drives are supported and the ports are Plug And Play.
2	Optical Disc Drive	TheOptical Disc Drive is used to read and write to and from optical media. The drive, depending on configuration, could be either a DVD Comb.
3	Kensington Lock Slot	The small port is used to secure the notebook to desks or workstations and prevent theft. The notebook lock is optional

1.6 Front View & Bottom View

The following is an overview of the Front & bottom of the notebook.

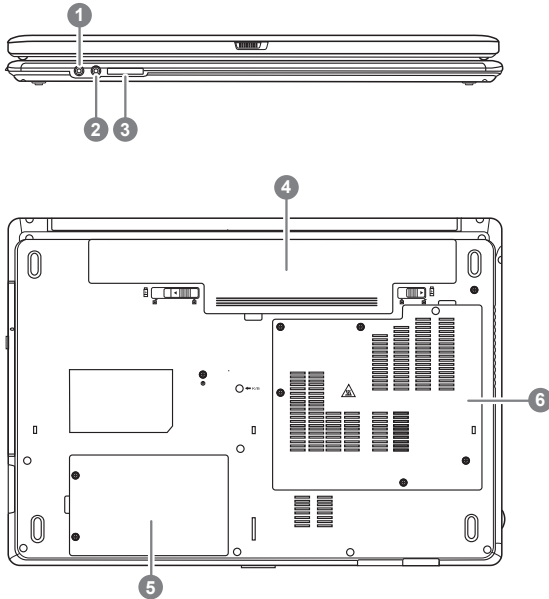

NO.	Item	Function
1	Headphone Jack	This port is used to connect external audio output devices such as speakers and headphones to the notebook to enhance the sound capabilities.
2	Microphone Jack	This port is used to connect an external amplified microphone to the notebook to enhance the voice recording and recognition of the notebook. Typical scenarios include online chat such as Skype.
3	Multi Card Reader	The memory card reader offers the fastest and most convenient method to transfer pictures, music and data between your notebook and flash compatible devices such as digital cameras, MP3 players, mobile phones, and PDAs.
4	Battery Bay	The battery bay contains the internal Lithium-Ion battery.
5	HDD Bay	HDD compartment cover.
6	Cooling Vents	These are open ports for the fan to dissipate heat from the computer's internal components. Do not block or place the computer in such a position that you inadvertently allow the outlets to become blocked.

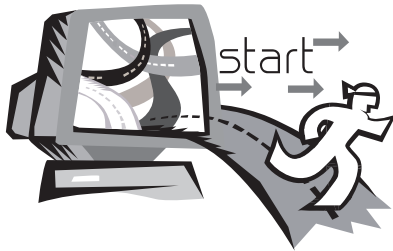

Chapter 2 Getting Started

This chapter will show you the various ports and components of the E1500 and familiarizes you with the notebook. Certain parts of the notebook can be user upgraded while others are fixed and cannot be changed.

2.1 Power Sources

Your computer has two types of power sources: a Lithium-Ion battery and an AC adapter.

Connecting the Power Adapters

The AC adapter provides power for operating your notebook PC as well as charging the battery.

Connecting the AC Adapter

1. Plug the DC output cable into the DC power jack of your.
2. Plug the AC adapter into an AC electrical outlet.

Switching from AC Adapter Power to Battery Power

1. Be sure that you have at least one charged battery installed.
2. Remove the AC adapter. Your notebook will automatically switch from DC power to battery power.

! CAUTION: The Lithium-Ion battery does not ship with a pre-charge initially. You will need to connect the AC adapter to use your notebook PC the first time.

It is recommended that only the AC adapter supplied with the E1500 is used. Any other adapter could cause damage or malfunction and might result in injury.

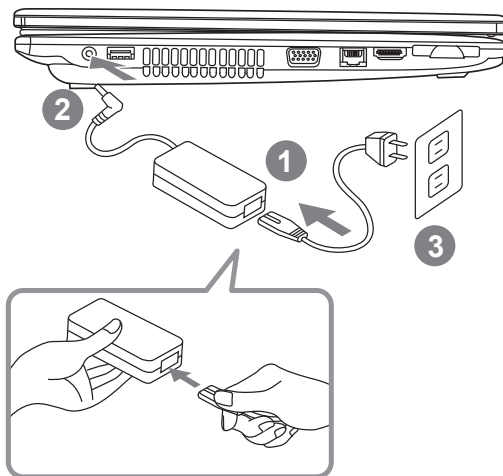

1. Connect the power cord to the AC adapter.
2. Connect the AC adapter to the DC power port of your computer.
3. Connect the AC adapter power cord to an AC outlet.

2.2 Recharging the Battery

The Lithium-Ion battery is recharged internally using the AC adapter. To recharge the battery, make sure the battery is installed and the computer is connected to the AC adapter.

There is no “memory effect” in Lithium-Ion batteries; therefore you do not need to discharge the battery completely before recharging. The charge times will be significantly longer if your notebook PC is in use while the battery is charging. If you want to charge the battery more quickly, put your computer into Suspend mode or turn it off while the adapter is charging the battery.

Low Battery State

When the battery charge is low, a notification message appears. If you do not respond to the low battery message, the battery continues to discharge until it is too low to operate. When this happens, your notebook PC goes into Suspend mode. There is no guarantee your data will be saved once the notebook reaches this point.



CAUTION: To protect your notebook from damage, use only the power adapter that came with it because each power adapter has its own power output rating.

Once your notebook PC goes into suspend mode as a result of a dead battery, you will be unable to resume operation until you provide a source of power either from an adapter or a charged battery. Once you have provided power, you can press the Suspend/Resume button to resume operation. In Suspend mode, your data is maintained for some time, but if a power source is not provided promptly, the power indicator stops flashing and then goes out, in which case you have lost the data that was not saved. Once you

provide power, you can continue to use your computer while an adapter charges the battery.

Battery Replacement

There is danger of explosion if an incorrect battery type is used for replacement. For computers equipped with a replaceable Lithium-Ion battery pack, the following applies:

- If the battery is placed in an OPERATOR ACCESS AREA, there shall be a marking close to the battery, or a statement in both the operating and the servicing instructions;
- If the battery is placed elsewhere in the computer, there shall be a marking close to the battery or a statement in the servicing instructions.

The marking or statement shall include the following or similar text:



CAUTION: Risk of explosion if battery is replaced with an incorrect type. Dispose of used batteries according to the instructions.

2.3 Starting Your Notebook

Suspend / Power on Button

The suspend/power on switch is used to turn on your notebook from its off state. Once you have connected your AC adapter or charged the internal Lithium-Ion battery, you can power on your notebook by pressing the suspend/power on button located above the keyboard. If you need to take an extended break, press the button again to turn it off.

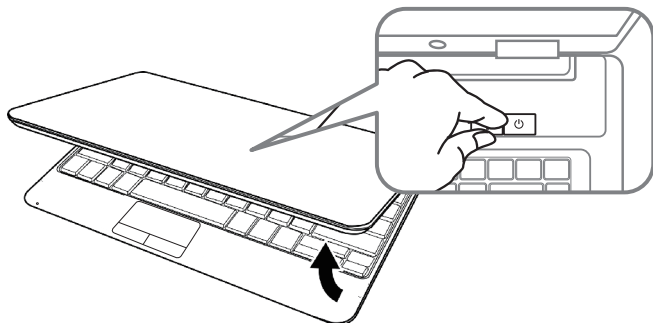

! CAUTION: Do not carry your notebook around with the power on or subject it to shocks or vibration, as you risk damaging the hard disk.

When you power on your notebook, it will perform a Power On Self Test (POST) to check the internal parts and configuration for correct functionality. If a fault is found, your computer emits an audio warning and/or displays an error message.

Depending on the nature of the problem, you may be able to continue by starting the operating system or by entering the BIOS setup utility and revising the settings. After satisfactory completion of the Power On Self Test (POST), your notebook loads the installed operating system.

! CAUTION Never turn off your notebook during the Power On Self Test (POST), or an unrecoverable error may occur.



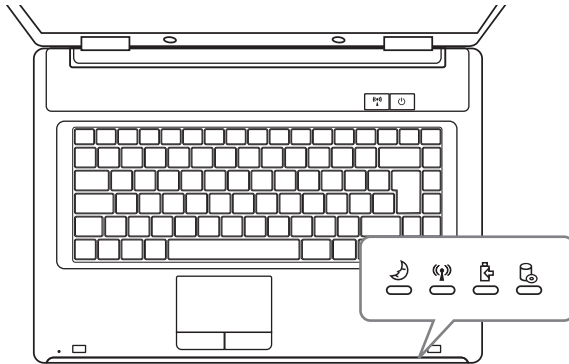

2.4 Status Indicators

The status indicator lights correspond to specific operating modes. These modes are: Power on/ Suspend status, Battery/AC Adapter status, hard drive activity (HDD), Num Lock, Caps Lock, and wireless transmission activity.



LED status indicators

These status indicators are used to show specific information on the E1500 such as if the Wireless LAN or Bluetooth is On or Off and if the Battery Pack is charging or not. From Left to Right they are:

NO.	Symbol	Item	Function
1		Power LED	Blue light indicates the system is ON. Blinking blue light indicates the notebook is in suspend mode.
2		Wireless Connection LED	Blue light indicates the WLAN/ Bluetooth is active.
3		Battery Status LED	Battery status Charging – Blue Full – Blue Low - Red
4		Hard Disk Activity Status LED	Blue light indicates the hard drive and / or optical drive is being accessed.

2.5 Using Function Keys

Your computer has 12 function keys, F1 through F12. The functions assigned to these keys differ for each application. You should refer to your software documentation to find out how these keys are used. The [FN] key provides extended functions for the notebook and is always used in conjunction with another key.



Fn+F1	Sleep This function will put the E1500 Notebook into sleep mode. The LCD will switch off and devices will switch to lower power mode.
Fn+F2	Fan Control This function will enable or disable the Silent Fan function. This will enable the user to put the fan into quiet mode if the user needs the notebook to be quieter.
Fn+F3	Mute Volume This function will mute the volume control in Windows and all sound output from the speakers will stop. Pressing this combination again will enable sound output.
Fn+F4	LCD / Display-Out Switch This function will switch the display configuration for the E1500 - It will cycle between 3 modes depending on operating system settings. These 3 Modes are: LCD Only - Image on the E1500 LCD Display Only - Image on external monitor LCD+Display - Image on LCD and external monitor
Fn+F5	Increase System Volume This function will gradually and incrementally increase the volume of the sound output from the E1500 speakers.

Fn+F6	Decrease System Volume This function will gradually and incrementally decrease the volume of the sound output from the E1500 speakers.
Fn+F7	Increase LCD Brightness This function will gradually and incrementally increase the brightness of the built in LCD panel.
Fn+F8	Decrease LCD Brightness This function will gradually and incrementally decrease the brightness of the built in LCD panel.
Fn+F9	Disable Touchpad This function will disable the built-in touchpad of the E1500 notebook. This function can be used if typing on the built-in keyboard so that the mouse pointer does not move.
Fn+F10	Wireless LAN On/Off This function will enable or disable the embedded Wireless LAN Connection. The LED Status indicator will be on when this is enabled and off when disabled.
Fn+F11	Webcam On/Off This function will enable or disable the built-in Webcam. This can be used when the webcam is not needed to save battery life or to disable images in conferencing software.

2.6 Using the Touchpad

A touchpad pointing device comes built into your computer. It is used to control the movement of the pointer to select items on your desktop and use applications on the notebook.

The touchpad consists of a cursor control, a left and right button, and a scroll bar. The cursor control works the same way a mouse does, and moves the cursor around the display. It only requires light pressure from the tip of your finger. The left and right buttons function the same as mouse buttons. The actual functionality of the buttons may vary depending on the application that is being used. The scroll bar allow you to navigate quickly through pages, without having to use the on-screen cursor to manipulate the up and down scroll bars.

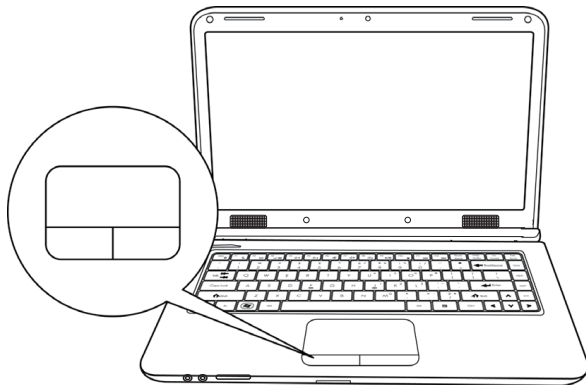

Clicking

Clicking means pushing and releasing a button. To left-click, move the cursor to the item you wish to select, press the left button once, and then immediately release it. To right click, move the mouse cursor to the item you wish to select, press the right button once, and then immediately release it. You also have the option to perform the clicking operation by tapping lightly on the touchpad once.

Double-Clicking

Double-clicking means pushing and releasing the left button twice in rapid succession. This procedure does not function with the right button. To double-click, move the cursor to the item you wish to select, press the left button twice, and then immediately release it. You also have the option to perform the double-click operation by tapping lightly on the touchpad twice.

Dragging

Dragging means pressing and holding the left button while moving the cursor. To drag, move the cursor to the item you wish to move. Press and hold the left button while moving the item to its new location and then release it. Dragging can also be done using the touchpad. First, tap the touchpad twice over the item you wish to move, making sure to leave your finger on the pad after the final tap. Next, move the object to its new location by moving your finger across the touchpad, and then release your finger. Using the Scroll bar allows you to navigate through a document quickly without using the window's scroll bars. This is particularly useful when you are navigating through on-line pages.



Chapter 3 GIGABYTE Smart Recovery

3.1 GIGABYTE Smart Recovery

System Recovery - Restore your E1500 operating system. The hard drive of the E1500 has a hidden partition that contains a full backup image of the operating system that can be used to recover the system in the event that something happens to the operating system.

! If the hard drive is removed or the partition deleted, the recover options will no longer be available and a recovery service will be needed.

Launch System Recovery

The system recover feature is part of the netbook installation and it ships preset from the factory. The options menu allows you to launch the Windows recovery tool to reinstall the operating system to factory defaults.

Below will briefly describe how to launch the recovery tool and to get the recovery started.

1. Turn off or restart the netbook.
2. Turn the netbook on and press and hold the F9 key to launch the tool.

3. The recovery window will open and give you the option to "Recovery" in the toolbar. You will be prompted if you want to recovery. Click on "Recovery" to begin the repair if you do.



4. The "Recovering" window will open and begin the recovery.



5. Once it is complete you will be prompted to reboot the netbook.

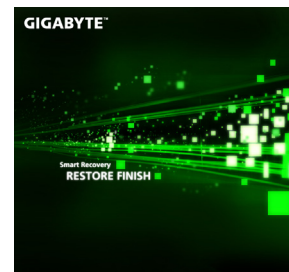



Chapter 4 Troubleshooting

This section will briefly cover some frequently encountered problems and questions and provide a quick guide to assist with solve these problems. Most problems can be resolved quickly, simply and easily and are not always a system problem. Should you encounter a problem that is not yet or differently listed, please consult the GIGABYTE website or call your unit supplier for assistance.

For website assistance go to the Support section of www.gigabyte.com.tw for telephonic assistance please call the supplier of your unit or take the unit to the supplier directly for assistance.

Troubleshooting

Your notebook PC is sturdy and subject to few problems in the field. However, you may encounter simple setup or operating problems that you can solve on the spot, or problems with peripheral devices, that you can solve by replacing the device. The information in this section helps you isolate and resolve some of these straightforward problems and identify failures that require service.

4.1 Identifying The Problem

If you encounter a problem, go through the following procedure before pursuing complex troubleshooting:

1. Turn off your notebook.
2. Make sure the AC adapter is plugged into your notebook and to an active AC power source.
3. Make sure that any card installed in the PC card slot is seated properly. You can also remove the card from the slot, thus eliminating it as a possible cause of failure.
4. Make sure that any devices connected to the external connectors are plugged in properly. You can also disconnect such devices, thus eliminating them as possible causes of failure.
5. Turn on your notebook. Make sure it has been off at least 10 seconds before you turn it on.
6. Go through the boot sequence.
7. If the problem has not been resolved, contact your support representative.

Before you place the call, you should have the following information ready so that the customer support representative can provide you with the fastest possible solution:

- Product name
- Product configuration number
- Product serial number
- Purchase date
- Conditions under which the problem occurred
- Any error messages that have occurred
- Hardware configuration
- Type of device connected, if any

See the configuration label on the bottom of your notebook for configuration and serial numbers.

Copyright-protected technology This product incorporates copyright protection technology that is protected by U.S. patents and other intellectual property rights. Use of this copyright protection technology must be authorized by Macrovision, and is intended for home and other limited viewing uses only unless otherwise authorized by Macrovision. Reverse engineering or disassembly is prohibited.

4.2 GIGABYTE Service Information

More service information please link to GIGABYTE official website: www.gigabyte.com.tw



Appendix

E1500 Specifications

Specifications	
Model	E1500
CPU	Intel® Montivena CPU
OS	support Windows 7
Chipsets	Mobile Intel® GL40
System Memory	DDRII 800MHz 2 slots Up to 4GB
Video Interface	Intel® GMA 4500
LCD	15.6" TFT-LCD WXGA, 1366 x 768 HD Glare type
Hard Disk Drive	2.5" 9.5mm SATA HDD 5400rpm (Supports capacities of 250/320/500 GB)
Optical Drive	DVD- Super Multi Drive
I/O Port	3x USB 2.0, D-SUBx1, 1x HDMI, 1x D-sub, 1x RJ45, Mic-in, Earphone-out, 4-in-1 Card Reader (SD/MMC/MS/MS Pro), DC-in Jack, 1x Kensington lock
Audio	2 channels/
Bluetooth	N/A
Webcam	Built-in 1.3M pixels webcam
LAN	Ethernet 10/100 Base T
Wireless LAN	802.11 b/g
Embedded HSDPA	NA
Protection	Kensington Lock
AC Adaptor	65w
Battery	Li-ion, 4-Cell, 2200 mAh or 6 cell
Dimension	369 x 260 x 35.61~43.27mm
Carry Bag	NA
Net Weight	2.66kg w/o batt

International Country Voltage

Region	Voltage	Frequency
Afghanistan	240V	50 Hz
Albania	220V	50 Hz
Algeria	230V	50 Hz
American Samoa	120V	60 Hz
Andorra	230V	50 Hz
Angola	220V	50 Hz
Anguilla	110V	60 Hz
Antigua	230V	60 Hz
Argentina	220V	50 Hz
Armenia	230V	50 Hz
Aruba	127V	60 Hz
Australia	230V	50 Hz
Austria	230V	50 Hz
Azerbaijan	220V	50 Hz
Azores	220V	50 Hz
Bahamas	120V	60 Hz
Bahrain	230V	50 Hz
Balearic Islands	220V	50 Hz
Bangladesh	220V	50 Hz
Barbados	115V	50 Hz
Belarus	220V	50 Hz
Belgium	230V	50 Hz
Belize	110V / 220V	60 Hz
Benin	220V	50 Hz
Bermuda	120V	60 Hz
Bhutan	230V	50 Hz
Bolivia	220V	50 Hz
Bonaire	127V	50 Hz
Bosnia	220V	50 Hz
Botswana	231 V	50 Hz

Region	Voltage	Frequency
Brazil	127V / 220 V	60 Hz
Brunei	240V	50 Hz
Bulgaria	230V	50 Hz
Burkina Faso	220V	50 Hz
Burundi	220V	50 Hz
Cambodia	230V	50 Hz
Cameroon	220V	50 Hz
Canada	120V	60 Hz
Canary Islands	220V	50 Hz
Cape Verde	220V	50 Hz
Cayman Islands	120V	60 Hz
Central African Republic	220V	50 Hz
Chad	220V	50 Hz
Channel Islands	230V	50 Hz
Chile	220V	50 Hz
China (mainland only)	220V	50 Hz
Colombia	120V	60 Hz
Comoros	220V	50 Hz
Congo-Brazzaville	230V	50 Hz
Congo-Kinshasa	220V	50 Hz
Cook Islands	240V	50 Hz
Costa Rica	120V	60 Hz
Côte d'Ivoire	230V	50 Hz
Croatia	230V	50 Hz
Cuba	110V	60 Hz
Cyprus	240V	50 Hz
Czech Republic	230V	50 Hz
Denmark	230V	50 Hz
Djibouti	220V	50 Hz
Dominica	230V	50 Hz

Region	Voltage	Frequency
Dominican Republic	110V	60 Hz
East Timor	220V	50 Hz
Ecuador	120V	60 Hz
Egypt	220V	50 Hz
El Salvador	115V	60 Hz
Equatorial Guinea	220V	50 Hz
Eritrea	230V	50 Hz
Estonia	230V	50 Hz
Ethiopia	220V	50 Hz
Faroe Islands	220V	50 Hz
Falkland Islands	240V	50 Hz
Fiji	240V	50 Hz
Finland	230V	50 Hz
France	230V (formerly 220V)	50 Hz
French Guiana	220V	50 Hz
Gaza Strip	230V	50 Hz
Gabon	220V	50 Hz
Gambia	230V	50 Hz
Georgia	220V	50 Hz
Germany	230V (formerly 220V)	50 Hz
Ghana	230V	50 Hz
Gibraltar	240V	50 Hz
Greece	230V (formerly 220V)	50 Hz
Greenland	220V	50 Hz
Grenada	230V	50 Hz
Guadeloupe	230V	50 Hz
Guam	110V	60 Hz
Guatemala	120V	60 Hz
Guinea	220V	50 Hz
Guinea-Bissau	220V	50 Hz

Region	Voltage	Frequency
Guyana	240V	60 Hz
Haiti	110V	60 Hz
Honduras	110V	60 Hz
Hong Kong	220V	50 Hz
Hungary	230V (formerly 220V)	50 Hz
Iceland	230V	50 Hz
India	220V	50 Hz
Indonesia	127V / 230V	50 Hz
Iran	220V	50 Hz
Iraq	230V	50 Hz
Ireland	230V (formerly 220V)	50 Hz
Isle of Man	240V	50 Hz
Israel	230V	50 Hz
Italy	230V (formerly 220V)	50 Hz
Jamaica	110V and 220V	50 Hz
Japan	100 V	50 Hz / 60Hz
Jordan	230V	50 Hz
Kazakhstan	220V	50 Hz
Kenya	240V	50 Hz
Kiribati	240V	50 Hz
Kuwait	240V	50 Hz
Kyrgyzstan	220V	50 Hz
Laos	230V	50 Hz
Latvia	220V	50 Hz
Lebanon	240V	50 Hz
Lesotho	220V	50 Hz
Liberia	120V / 240V	50 Hz
Libya	127V	50 Hz
Lithuania	230V (formerly 220V)	50 Hz
Liechtenstein	230V	50 Hz

















Region	Voltage	Frequency
Luxembourg	230V (formerly 220V)	50 Hz
Macau S.A.R. of China	220V	50 Hz
Macedonia	220V	50 Hz
Madagascar	127V / 220 V	50 Hz
Madeira	220V	50 Hz
Malawi	230V	50 Hz
Malaysia	240V	50 Hz
Maldives	230V	50 Hz
Mali	220V	50 Hz
Malta	230V	50 Hz
Martinique	220V	50 Hz
Mauritania	220V	50 Hz
Mauritius	230V	50 Hz
Mexico	127V	60 Hz
Micronesia	120V	60 Hz
Moldova	220-230V	50 Hz
Monaco	127V / 220 V	50 Hz
Mongolia	230 V	50 Hz
Montenegro	220V	50 Hz
Montserrat (Leeward Is.)	230V	60 Hz
Morocco	127V / 220 V	50 Hz
Mozambique	220V	50 Hz
Myanmar/Burma	230V	50 Hz
Namibia	220V	50 Hz
Nauru	240V	50 Hz
Nepal	230V	50 Hz
Netherlands	230V (formerly 220V)	50 Hz
Netherlands Antilles	127V / 220V	50 Hz
New Caledonia	220V	50 Hz







Region	Voltage	Frequency
New Zealand	230V	50 Hz
Nicaragua	120V	60 Hz
Niger	220V	50 Hz
Nigeria	240V	50 Hz
North Korea	220V	50 Hz
Norway	230V	50 Hz
Okinawa	100 V	60 Hz
Oman	240V	50 Hz
Pakistan	230V	50 Hz
Panama	110V	60 Hz
Papua New Guinea	240V	50 Hz
Paraguay	220V	50 Hz
Peru	220V	60 Hz
Philippines	220V	60 Hz
Poland	230V	50 Hz
Portugal	220V	50 Hz
Puerto Rico	120V	60 Hz
Qatar	240V	50 Hz
Réunion	220V	50 Hz
Romania	230V (formerly 220V)	50 Hz
Russian Federation	220V	50 Hz
Rwanda	230V	50 Hz
St. Kitts and Nevis	110V / 230V	60 Hz
St. Lucia (Winward Is.)	240V	50 Hz
St. Vincent (Winward Is.)	230V	50 Hz
São Tomé and Príncipe	220V	50 Hz
Saudi Arabia	127V / 220V	60 Hz
Senegal	230V	50 Hz
Serbia	220V	50 Hz

Region	Voltage	Frequency
Seychelles	240V	50 Hz
Sierra Leone	230V	50 Hz
Singapore	230V	50 Hz
Slovakia	230V	50 Hz
Slovenia	230V	50 Hz
Somalia	220V	50 Hz
South Africa	220V	50 Hz
South Korea	220V	60 Hz
Spain	230V (formerly 220V)	50 Hz
Sri Lanka	230V	50 Hz
Sudan	230V	50 Hz
Suriname	127V	60 Hz
Swaziland	230V	50 Hz
Sweden	230V	50 Hz
Switzerland	230V	50 Hz
Syria	220V	50 Hz
Tahiti	110V / 220V	60 Hz / 50 Hz
Taiwan	110V	60 Hz
Tajikistan	220V	50 Hz
Tanzania	230V	50 Hz
Thailand	220V	50 Hz
Togo	220V	50 Hz
Tonga	240V	50 Hz
Trinidad & Tobago	115V	60 Hz
Tunisia	230V	50 Hz
Turkey	230V	50 Hz
Turkmenistan	220V	50 Hz
Uganda	240V	50 Hz
Ukraine	220V	50 Hz

Region	Voltage	Frequency
United Arab Emirates	220V	50 Hz
United Kingdom	230V (formerly 240V)	50 Hz
United States of America	120V	60 Hz
Uruguay	230V (formerly 220V)	50 Hz
Uzbekistan	220V	50 Hz
Vanuatu	230V	50 Hz
Venezuela	120V	60 Hz
Vietnam	220V	50 Hz
Virgin Islands	110V	60 Hz
Western Samoa	230V	50 Hz
Yemen	230V	50 Hz
Zambia	230V	50 Hz
Zimbabwe	220V	50 Hz

Plug Type

Country	Plug Type	Plug Picture	Connector Type	Connector Picture
USA	LP-30B		LS15	
Canada				
Japan	LP-54		LS15	
Taiwan	LP-53		LS15	
China	PC-323		LS15	
Korea	LP-E04		LS15	
England	LP-60L		LS15	
Singapore				
South Africa	PE-364		LS15	
	PE-361		LS15	

Australia	LP-23A		LS15	
Germany	LP-33		LS15	
France				
Sweden				
Finland				
Norway				
Belgium				
Netherlands				
Austria				
Switzerland				
Denmark	LP-38		LS15	
Italy	PE-336		LS15	