

90cm Built In Oven

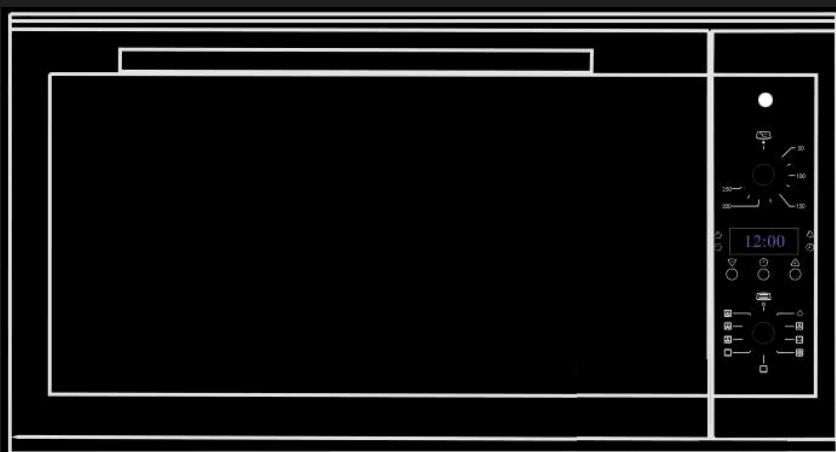

Installation and User manual

Content

Important Safety instructions-----	1
Product description-----	3
Installation-----	4
Oven setting-----	6
Cooking guide-----	11
Maintenance and cleaning-----	14
Warranty-----	17

For warranty service call 1300 373 199 to connect you to the nearest authorised service centre

BO908CX

This manual explains the proper installation and use of your oven, please read it carefully before using even if you are familiar with the product. The manual should be kept in a safe place for future reference.

General Warnings

- ◆ If the supply cord is damaged, the cord must be replaced by the manufacturer, its service agent or similarly qualified persons in order to avoid a hazard.
- ◆ This product has not been designed for any uses other than those specified in this booklet
- ◆ This appliance must not be used as a space heater.
- ◆ In order to avoid fire, the appliance must be kept clean and vents kept unobstructed.
- ◆ Do not spray aerosols within the vicinity of the appliance during operation.
- ◆ Do not store flammable materials in or under the appliance, e.g. aerosols.
- ◆ Do not line the bottom of the oven with foil or cookware.
- ◆ Always use gloves when handling hot items inside the oven.
- ◆ Always turn the grill off immediately after use as fat left behind may catch fire.
- ◆ Do not leave the appliance unattended when cooking. Oils and fats may catch fire due to overheating or boiling over.
- ◆ Do not put pans weighing over 15Kgs on the opened door of the oven.
- ◆ Do not use the appliance in the event of a technical fault. Any faults must be fixed by an appropriately qualified and authorised person.
- ◆ In the event of any incident caused by a technical fault, disconnect the power and report the fault to the service centre to be repaired.
- ◆ The rules and provisions contained in this instruction manual should be strictly observed.
- ◆ Do not allow anybody who is not familiar with the contents of this instruction manual to operate the appliance.

Child Safety

- ◆ This appliance is not intended for use by persons (including children) with reduced physical, sensory or mental capabilities, or lack of experience and knowledge, unless they've been given supervision or instruction concerning use of the appliance by a person responsible for their safety.
- ◆ Children should be supervised to ensure that they do not play with the appliance.
- ◆ During use this appliance becomes hot. Care should be taken to avoid touching hot surfaces, e.g. oven door, heating elements.
- ◆ Accessible parts will also become hot when in use. To avoid burns and scalds children should be kept away.

Installation, Cleaning & Servicing

- ◆ The appliance must be installed only by an authorised person in compliance with the instructions provided. Incorrect installation may cause harm to persons, animals or may damage property.
- ◆ Before using the appliance, ensure that all packing materials are removed from the appliance.
- ◆ In order to avoid any potential hazard, the enclosed installation instructions must be followed.
- ◆ Ensure that all specified vents, openings and air spaces are not blocked.
- ◆ The panels adjacent to the oven must be made of heat-resistant material.
Cabinets with a veneer exterior must be assembled with glues which can withstand temperature of up to 120°C.

- ◆ To reduce the risk of fire, do not place or install this unit in areas where the ventilation or circulation ducts may become blocked. Make sure there is at least 70mm of space between the back of your oven and the wall. Keep some distance on each side of your oven that you can use that distance following installing instructions.
- ◆ The unit's power cord must be connected to a properly grounded and protected, 220-240V electrical outlet. Always use ground fault protection where required by the electrical code.
- ◆ When transporting or storing the unit, keep it in a dry location, free from dust, excessive vibration or other factors, which may damage the unit.
- ◆ Do not operate oven with a damaged cord, plug or if the oven has malfunctioned or has been dropped or damaged in any manner. Return oven to authorised service facility for repair.
- ◆ Only authorised personnel should carry out servicing. (Certificate of Compliance to be retained)
- ◆ Always ensure the appliance is switched off before cleaning or replacing parts.
- ◆ Do not use steam cleaners, as this may cause moisture build-up.
- ◆ Always clean the appliance immediately after any food spills.
- ◆ **THIS APPLIANCE MUST BE EARTHED.**
- ◆ To maintain safe operation, it is recommended that the product be inspected every five years by an authorised service person.

Oven

- ◆ During use the appliance becomes hot. Care should be taken to avoid touching the hot surfaces inside the oven.
- ◆ Switch the appliance off before removing the oven light glass for globe replacement.
- ◆ To avoid an accident, ensure that oven shelves and fittings are always inserted into the appliance in accordance with the instructions.

- ◆ Do not use the door as a shelf.
- ◆ Do not push down when the oven door is open.

Grill

- ◆ Do not cover the grill insert with foil, as fat built up may catch on fire.
- ◆ Always keep the grill dish clean as any build up may catch on fire.
- ◆ Do not leave the grill on unattended.
- ◆ To avoid fire, ensure that grill trays and fittings are always inserted into the appliance in accordance with the instructions.
- ◆ Do not place thick portions of food under the grill. Foods may curl, catch and ignite.
- ◆ Accessible parts may become hot when grill is in use. Children should be kept away.

Environmental Hints

- ◆ Use the oven efficiently, by cooking many trays of food at the same time.
- ◆ Cook 2 trays of scones, small cakes or sausage rolls at the same time.
- ◆ Select the correct shelf location for food being cooked.
- ◆ Do not open the oven door more than necessary.
- ◆ After the oven is turned off it retains heat for some time.



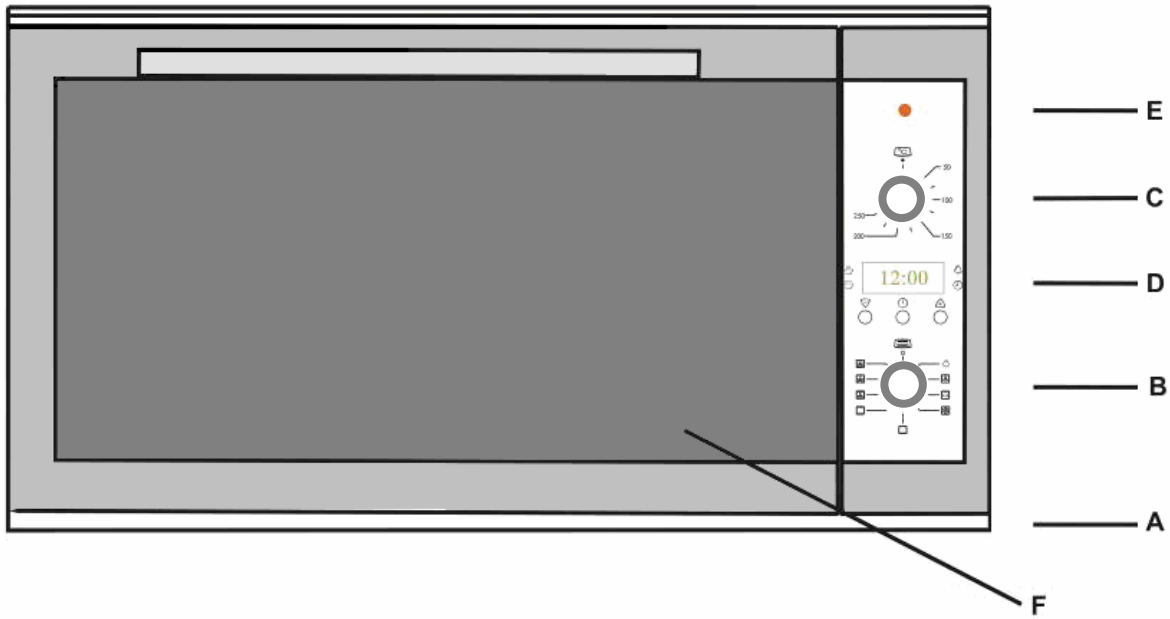

This product must not be disposed together with domestic waste. This product has to be disposed at an authorised place for recycling of electrical and electronic appliances.

By collecting and recycling waste, you help save natural resources, and make sure the product is disposed in an environmental friendly and healthy way.

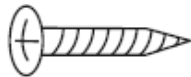
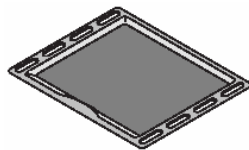

- A. Control Panel
- B. Function Select Knob
- C. Temperature Select Knob
- D. Electronic Programmable Clock (3-Keys)
- E. Heating Indicator Light
- F. 3 Layer Glass Door

Accessory Name	Picture	Quantity
Screws(ST4x25)		4
Baking Pan		1
Grill Rack 1		1
Grill Rack 2		1

Technical Data

model	product dimensions (h x w x d) mm	electrical connection	min. fuse rating	max. power rating	max. current rating
BO908CX	475x895x548	220-240V/50Hz	15A	2.8 – 3.4Kw	14.2A
Heating elements				Motor	
Oven lower heating el.: 1300Watt	Medium grill heating el.:	2000 Watt	Fan motor	25 Watt	
Oven upper heating el.: 1050Watt	Total grill heating el.:	1050+2000 Watt			
Oven light: 15Watt	Circle heating el.:	2800Watt			

WARNING!

Please follow the points below when installing the appliance

Use An Authorised Person

- ◆ Installation should be carried out according to the instructions by a professionally qualified person. The manufacturer declines all responsibility for any damage to persons, animals or things due to a wrong installation.
- ◆ Wiring connections must be in accordance with AS/NZS 3000 Wiring Rules and any particular conditions of the local authority.
- ◆ Refer to data plate for rating information. The data plate is positioned behind the bottom of the oven door. The circuit diagram is positioned on the top panel of the appliance.
- ◆ A functional switch should be provided near the appliance in an accessible position. Refer to AS/NZS 3000 clause 4.7.1
- ◆ Wiring should be protected against mechanical failure. Refer to AS/NZS 3000 clause 1.5
- ◆ A means of disconnection with a contact separation of at least 3mm must be supplied in the fixed wiring. Always turn the grill off immediately after use as fat left behind may catch fire.
- ◆ Unplug the power plug of appliance from socket before installation or any adjustment or maintenance.

This Appliance Must Be Properly Earthed

- ◆ Do not lift the appliance by the door handles.
- ◆ Prepare the cupboard opening to match your appliance measurements. (See diagrams)
- ◆ Slide appliance into the cupboard, ensuring that the supply cable (where fitted) does not kink.
- ◆ To prevent tipping, secure your oven into the cupboard by fastening with 4 screws supplied.
- ◆ Where the appliance is built into a cabinet, the cabinet must be capable of withstanding 70°C. Installation into low temperature tolerant cabinetry (e.g. Vinyl coated) may result in deterioration of the low temperature coating by discoloring or bubbling.

- ◆ The unit panels next to the appliance must be heat resistant. In the case of veneered wood units, glue must be resistant to a temperature of 120°C.
- ◆ If the appliance is to be installed adjacent to vinyl wrapped surfaces, use an installation kit available from the vinyl-wrap supplier.
- ◆ GSM cannot accept responsibility for damage caused by installation into low temperature tolerant cabinets.
- ◆ After installation, test and ensure that the appliance operates correctly before handing it over to the customer.
- ◆ Once the appliance is installed, there must be no possible contact with electrical parts. Any protective parts must can only be removed with the use of tools
- ◆ If a power point is fitted, it must be accessible with the appliance installed, as the plug must be accessible after installation

To avoid any potential hazard, you must follow our instructions when you install your appliance. Failure to install the appliance correctly could invalidate any warranty or liability claims and lead to prosecution.

Cabinet Construction For Your Appliance

The sizes of the unit for installing the cooker under a worktop or in a column unit are shown in figure.

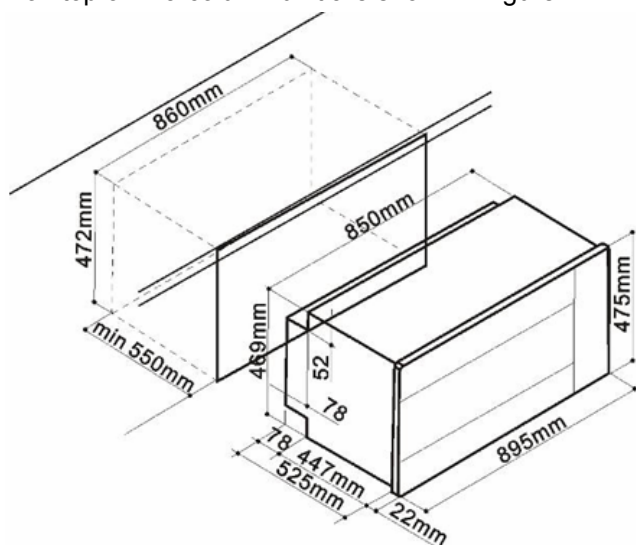

To provide adequate ventilation, there must be appropriate ventilation opening, the panel to which the oven is fitted should have a gap of at least 70 mm at the rear.

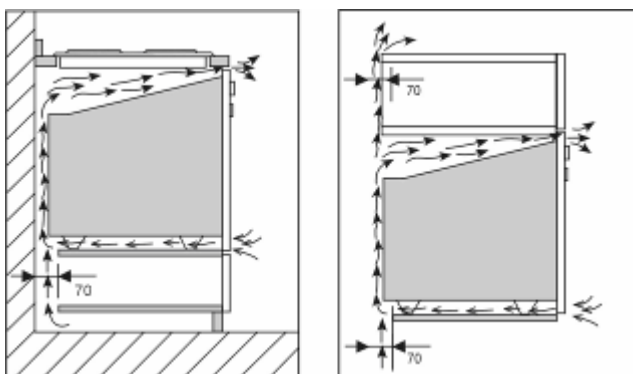

The unit panels next to the cooker must be heat resistant. In the case of veneered wood units, glues must be resistant to a temperature of 120°C.

Fitting Your Appliance

Fit the appliance into its surround (beneath a work-top or above another appliance) by inserting screws into the 4 holes that can be seen in the frame of the oven when the door is open.

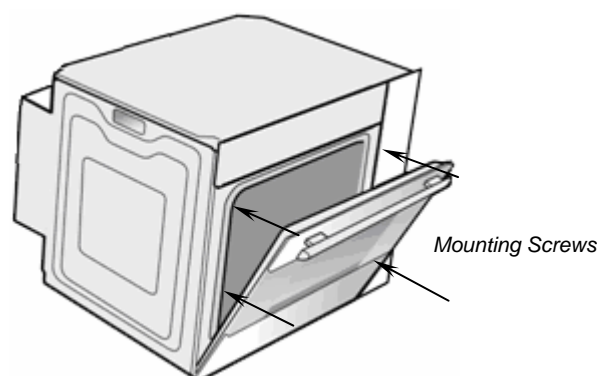

Note:

Your appliance must be mounted on a flat surface for the full width and depth of the product

Connect Power Supply Cord

- ◆ Pull open terminal board cover at rear panel of appliance.
- ◆ Fit wires through on terminal board and make connections to terminals.
- ◆ Engage wires into plastic clip. Secure plastic clip with supplied screws.
- ◆ Close the terminal board cover.

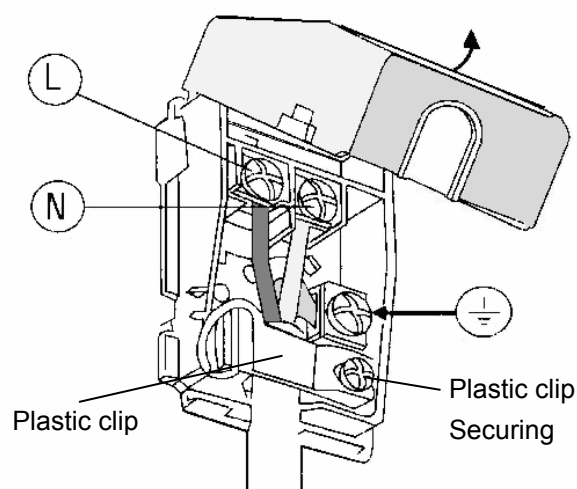

Preparing Your Oven



1. Please remove all stickers, leaflets and boxes from the door and from the floor of the oven before operation.
2. Please wipe out the oven interior prior to operation with warm soapy water and polish dry with a soft clean cloth.





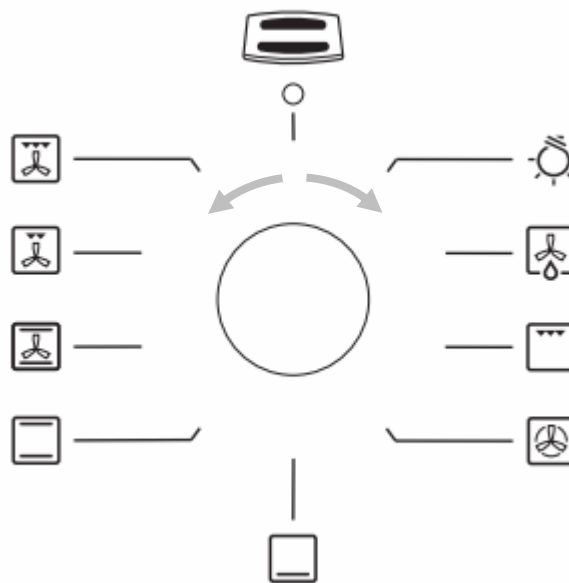

Do not close the oven door until the oven is completely dry.

Select The Functions

Turn the function selector in any direction to the desired function. The oven cavity light will turn on.



Function	Description
Oven Light 	When the selector knob is in any position other than the “0” position, the oven light comes on. Attention: The first time you use the oven we recommend that you set the thermostat on the highest setting and leave the oven on for about a half an hour with nothing in it. Then, open the oven door and let the room air. The odour that is often detected during this initial use is due to the evaporation of substances used to protect the oven during storage and until it is installed.
Convection Mode 	Set the thermostat knob (c) between 50°C and 250°C. The outer heating elements at both the top and the bottom of the oven will come on. The heat is distributed uniformly from top to the bottom. The convection mode is recommended for preparing meat-based dishes featuring of liquids. It still remains the best cooking mode for dry pastries and fruit in general. When cooking in convection mode, only use one dripping-pan or cooking rack at a time, otherwise the heat distribution will be uneven. Select from among the various rack heights based on whether the dish needs more or less heat from the top or bottom.
Ventilated Convection Mode 	Set the thermostat knob (c) between 50°C and 250°C. The outer heating elements at both the top and the bottom of the oven are activated, as well as the fan. Based on the convection model, this combination of features increases the effectiveness of the thermal radiation of the heating elements through forced air circulation of the air throughout the oven. This helps prevent foods from burning on the surface, allowing the heat to penetrate into the food.

<p>Lower Heating Element</p> 	<p>Set the thermostat knob (C) between 50°C and 250°C. By turning the knob to this position. The oven light and lower heating element come on.</p> <p>This position is recommended for finishing the cooking of food (in baking trays) which is already superficially well-cooked but still soft inside.</p>
<p>Ventilated & Medium Grill</p> 	<p>Important: Do not set thermostat knob (C) to over 175°C. During grilling, keep the oven door closed. The central heating elements of the top are activated as well as the fan. This combination of features increases the effectiveness of the thermal radiation of the heating elements through forced air circulation of the air throughout the oven. This helps prevents foods from burning on the surface, allowing the heat to penetrate into the food.</p>
<p>Maximum Grill</p> 	<p>This feature activated all upper heating elements and give rapid cooking to food.</p>
<p>Ventilated Max Grill</p> 	<p>Important: Do not the thermostat knob (C) to over 175°C. During grilling, keep the oven door closed. Both of the heating elements of the grill are activated, as well as the fan. This combination of features increases the effectiveness of the thermal radiation of the heating elements through forced air circulation of the air throughout the oven. This helps prevents foods from burning on the surface, allowing the heat to penetrate into the food.</p> <p>For a better distribution of heat, not only to brown the surface but also to cook the bottom part, select this mode. This mode can also be used for browning foods at the end of the cooking process</p>
<p>Ventilation Mode</p> 	<p>Set the thermostat knob (C) between 50°C and 250°C. The circular heating element and the fan will come on. Since the heat remains constant and uniform throughout the oven, the air cooks and browns food uniformly over its entire surface. With this mode, you can also cook various dishes at the same time, as long as their respective cooking temperatures are the same. A maximum of 2 rack levels can be used at the same time. This cooking mode is ideal for au gratin dishes or those which require an extended cooking time.</p> <p>The excellent heat distribution makes it possible to use lower temperatures when cooking roasts. This results in less loss of juices, meat which is more tender and a decrease in the loss of weigh for the roast. The ventilated mode is especially suited for cooking fish, which can be prepared with the addition of a limited amount of condiments, thus maintaining their flavour and appearance. The ventilated mode can also be used to thaw white or red meat, fish and bread by setting the temperature to 80°C -100°C.</p>
<p>Defrost</p> 	<p>Select this function to defrost more delicate foods. In this mode you use only the cold air circulation.</p>

Select The Temperature

- ◆ To set the temperature, turn the temperature selector in a clockwise direction to the desired setting. An indicator light above the temperature selector will come on.
- ◆ A thermostat controls the temperature in your appliance. When the temperature is reached, the heating source switches itself off and the indicator light goes out. When the oven temperature falls below the desired setting, the heating source switches on and the indicator light comes on again.
- ◆ Once the food is cooked, turn the temperature selector back in an anti-clockwise direction. Do not force it right round in a clockwise direction as this will result in damage to the thermostat.

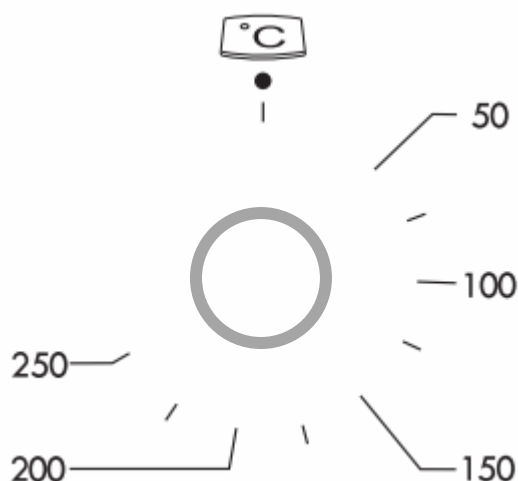

Important





- ◆ The desired cooking function must be selected before the oven will operate.

Time Features

Your oven is equipped with a 3 button timer that has the following features:





- ◆ O'clock time – you can set current O'clock time
- ◆ Timer – you can set a countdown time that will beep when the set time has elapsed.
- ◆ Cooking duration – you can set cooking duration. A timer will count down the preset cooking time, beep when the time has elapsed and turn the appliance off.
- ◆ Cooking end time – instead of setting a cooking duration you can set a cooking finish O'clock time. When the finish time has been reached the timer will beep and turn the appliance off.
- ◆ Delayed start cooking time – you can combine the cooking duration and end cooking time to switch oven on and off at a specific time during the day.

O'Clock Time Setting

- ◆ Press the  button until the  'indicator' begins flashing.
- ◆ Press the  and  buttons to change the time of day. 5 seconds after the last change, the  'indicator' will disappear, confirming the time has been adjusted.





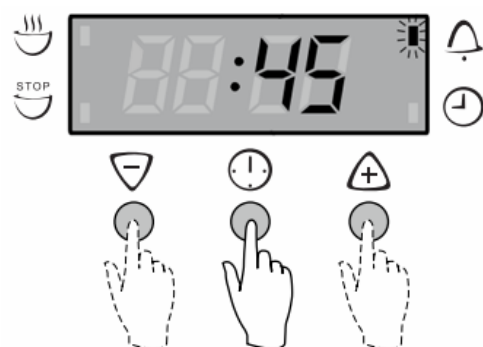

Timer Setting

- ◆ Press the  button until the  'indicator' begins flashing.
- ◆ Set the countdown time you wanted by using the  and  buttons. 5 seconds after the last change the  'indicator' will stop flashing and the countdown will start in minutes.
- ◆ To stop the beeper, press any button.





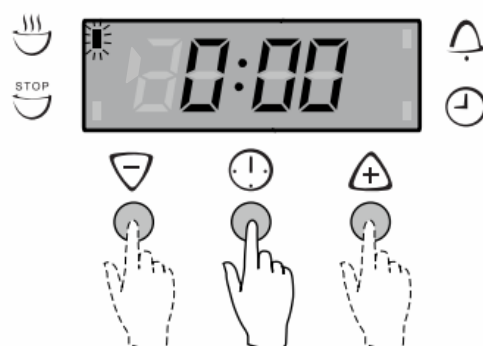

Cooking Duration Setting

- ◆ Select the desired oven function and temperature.
- ◆ The oven indicator light will glow and the heating source will come on.
- ◆ Press the  button until the  'indicator' begins flashing.
- ◆ Set the cooking duration you want by using the  and  buttons. 5 seconds after the last change the  'indicator' will stop flashing, and the time of day will be displayed.

* Remember to add pre-heating time if necessary.





Cooking End Time Setting











- ◆ Check the display shows the correct O'clock time of day.
- ◆ Select the desired oven function and temperature.
The oven indicator light will glow and the heating source will come on.
- ◆ Press the  button until the  'indicator' begins flashing.
- ◆ Enter the O'clock time of day you want to finish cooking by using the  and  buttons. 5 seconds after the last change, the  'indicator' will stop flashing and the current time of day will be displayed.





Delayed Start Cooking Time Setting

- ◆ Set the cook time and end time as described in the previous sections.
- ◆ Once both the cook time and end time have been set, the  and the  'indicators' will stop flashing and the current time of day will be displayed.

To Check Or Cancel Settings

- ◆ To check your settings, press the  button until the setting you want is displayed. An indicator (,  etc) that is currently on display.
- ◆ To cancel "delayed start" press the  button until a light flashes next to . Press and hold the  button until the clock no longer reverses (you will hear a beep). If you have left the temperature and function knobs at a setting the oven will start once the  indicator stops flashing.
- ◆ To cancel "auto shut off" press the  button until the  indicator flashes. Press and hold the  button until the clock no longer reverses (at 0:00 you will hear a beep). This automatically cancels "delayed start". If you have left the temperature and function knobs at a setting, the oven will start once the  indicator stops flashing. Because you have cancelled "auto off" the oven will continue to heat until you manually turn it off.

On Completion Of Cooking

- ◆ The heat source will turn off, the timer will beep and the  and/or  'indicators' will flash.
- ◆ Even though the heating element turns off the oven will still retain substantial heat. This will continue to cook the food until it is removed or the oven cools down. If you do not plan on being present when the oven turns off, you should take this extra heating time into account.
- ◆ Turn the function and temperature controls to the off position.
- ◆ Press any button to stop the timer beeping.

Important

- ◆ Select the correct shelf location for food being cooked.
- ◆ Make sure dishes will fit into the oven before you switch it on.
- ◆ Keep edges of baking dishes at least 40mm from the side of the oven. This allows free circulation of heat and ensures even cooking.
- ◆ Do not open the oven door more than necessary.
- ◆ Do not place foods with a lot of liquid into the oven with other foods. This will cause food to steam and not brown.
- ◆ After the oven is turned off it retains the heat for some time. Use this heat to finish custards or to dry bread.
- ◆ Do not use a lot of cooking oil when roasting. This will prevent splattering oil on the sides of the oven and the oven door.
- ◆ When cooking items that require a high heat (e.g. tarts), place the cooking dish on a scone tray in the desired shelf position.
- ◆ For sponges and cakes use aluminum, bright finished or non-stick cookware.
- ◆ If the oven must be preheated (generally this is the case when cooking leavened foods) the " Ventilation mode " as possible in order to save on energy
- ◆ Always use the grill with the oven door closed. This will allow you both to attain excellent results and to save energy
- ◆ Always clean the grill/oven dish after every use. Excessive fat build up may cause a fire.

Cooking Pizza

For best results when cooking pizza use the Ventilation mode:

- ◆ Preheat the oven for at least 10 minutes;
- ◆ Use a light aluminium pizza pan, placing it on the broiler supplied with the oven. If the dripping-pan is used, this will extend the cooking time, making it difficult to get a crispy crust;
- ◆ Do not open the oven door frequently while the pizza is cooking;
- ◆ If the pizza has a lot of toppings (three or four), it is recommended that the mozzarella cheese be placed on top halfway through the cooking process;

Cooking Fish & Meat

- ◆ Meat must weigh at least 1 Kg in order to prevent it from drying out. When cooking white meat, chicken and fish, use low temperature settings (150°C - 220°C). For red meat that should be well done on the outside while tender and juicy in the inside, it is a good idea to start with a high temperature setting (200°C - 220°C) for a short time, then turn the oven down afterwards. In general, the larger the roast, the lower the temperature setting. Place the meat on the centre of the rack and place the dripping pan beneath it to catch the fat.
- ◆ Make sure that the rack is inserted so that it is in the centre of the oven. If you would like to increase the amount of heat from below, use the low rack heights. For savoury roasts (especially duck and wild game), dress the meat with lard or bacon on the top.

Recommended Cooking Menu

Pastries and cakes	recommended temperature(°C)	Cooking time (Minutes)
Fruit Pie	130	60-70
Meringues	130	30-40
Sponge Cake	150	20-30
Angel Cake	160	40-50
Madeira Cake	160	40-50
Chocolate Cake	170	30-40
Flat Sweet Loaf	170	40-50
Puffs	200	15-20
Flaky Pastry Biscuits	200	15-20
Mille Feuilles	200	15-20
Short Pastry	200	15-20

Meat and Fish	recommended temperature(°C)	Cooking time (Minutes)
Beef - Rare	200	35-40
- Medium		45-50
- Well done		55-60
Lamb - Medium	200	40
- Well done		60
Pork	200	60
Duck	180-200	60-70
Chicken	180	45-50
Veal	180	60
Fish	200	15-25

* Cooking times may vary according to the nature of the foods, their homogeneity and their volume. When cooking a certain food for the first time, it is advisable to choose the lowest values in the cooking time range given in the table and then increase them if necessary.

Grill Guide

As a method of cooking, grilling can be used to:

- ◆ Enhance the flavors of vegetables, fish, poultry and meat.
- ◆ Seal the surface of the food and retain natural juices.
- ◆ You can grill with the door open or closed.

This table shows how to grill different types of meat:

Food	Grilling method
Beef	You can use tenderloin, rump and sirloin. Brush with oil or melted butter, especially if the meat is very lean.
Lamb	You can use the loin chops, short loin chops, chump chops and forequarter chops. Remove skin or cut at intervals to avoid curling. Brush with oil or melted butter.
Sausages	Prick sausages to stop skin from bursting.
Poultry	Divide into serving pieces. Brush with oil.
Fish	Brush with oil or melted butter and lemon juice.
Bacon	Remove rind. Grill fat and make into rolls.

This table shows how to grill different types of dish:

Type Of Dish	Cooking Time (Minutes)	Position Of Shell
Chops (0.5 kg)	min. 25	3 rd guide rail
Sausages	min. 15	2 nd guide rail
Grilled Chicken (1 kg)	min. 60	1 st guide rail
Veal On The Spit (0.6 kg)	min. 60	-
Chicken On The Spit (1 kg)	min. 60	-

* When utilising the grill, place the rack at the lower levels (see cooking table). To collect grease or fat and prevent smoke, place a dripping-pan at the bottom rack level.

Baking Pastries

When baking pastries, always place them in the oven after it has been preheated. Make sure you wait until the oven has been preheated thoroughly (the red “E” light will turn off). Do not open the door while the pastry is cooking in order to prevent it from dropping.

Baking must not be too runny, as this will result in prolonged cooking times. In general:

If	Suggestion
Pastry is too dry	Increase the temperature by 10°C and reduce the cooking time.
Pastry dropped	Use less liquid or lower the temperature by 10°C
Pastry is too dark on top	Place it on a lower rack, lower the temperature, and increase the cooking time.
Cooked well on the inside but sticky on the outside	Use less liquid, lower the temperature, and increase the cooking time.
The pastry sticks to the pan	Grease the pan well and sprinkle it with a dusting of flour.
Using more than one level and they are not all at the same cooking point	Use a lower temperature setting. It is not necessary to remove the food from all the racks at the same time.

Troubleshooting

Faults	Causes	Remedies
The upper crust is dark and the lower part too pale	Not enough heat from the bottom	<ul style="list-style-type: none"> - Use the natural convection position - Use deeper cake tins - Lower the temperature - Put the cake on a lower shelf
The lower part is dark and the upper crust too pale	Excessive heat from the bottom	<ul style="list-style-type: none"> - Use the natural convection position - Use lower side tins - Lower the temperature - Put the cake on a higher shelf
The outside is too cooked and the inside not cooked enough	Too high temperature	<ul style="list-style-type: none"> - Lower the temperature and increase the cooking time
The outside is too dry even though of the right color	Too low temperature	<ul style="list-style-type: none"> - Increase the temperature and reduce the cooking time.
The appliance does not work	Break in power supply	Check the household fuse box, if there is a blown fuse replaces it with a new one.
The oven lighting does not work	Bulb is loose or damaged	tighten up or replace the blown bulb (see chapter Cleaning and Maintenance)

*New appliances could have a smell during first use. It is recommended to 'run in' the oven before you cook for the first time. Operate the oven, empty, at a temperature of 180°C for approximately 2-4 hours. Please ensure the room is well ventilated during this process.

WARNING!

- ◆ Before cleaning your oven, or performing maintenance, disconnect it from the power supply.
- ◆ Do not use steam cleaners.
- ◆ Do not line the oven bottom with aluminium foil, as the consequent accumulation of heat could compromise the cooking and damage the enamel.
- ◆ To protect against the risk of electrical shock, do not immerse the unit, cord or plug in water or other liquid or sprinkle water to clean the appliance!
- ◆ Do not clean the appliance when it is still hot! The inside and external surface of the oven should preferably be cleaned by damp cloth when it is cooled down.
- ◆ Wash all accessories in hot soapy water or in a dishwasher and wipe dry with a paper or cloth towel.
- ◆ If you use your oven for an extended period of time, condensation may form. Dry it using a soft cloth.

Stainless Steel

- ◆ All grades of stainless steel can stain, discolour or become greasy. You must clean these areas regularly by following the procedures below, if you want your appliance to look its best, perform well and have a long life.
- ◆ Care must be taken when wiping exposed stainless steel edges, they can be sharp!
- ◆ The front frame around the oven can be cleaned with stainless steel cleaners if it becomes soiled or discoloured.
- ◆ The stainless steel should only be cleaned with warm water and a mild detergent.
- ◆ Do not use stainless steel cleaners, abrasive cleaners or harsh solvents.
- ◆ Make sure you follow the polish or brushing lines in the steel.

Glass

- ◆ Glass surfaces on doors and control panels are best cleaned immediately after soiling.
- ◆ A damp cloth may help remove baked on food deposits.
- ◆ Oven cleaners can be used to remove stubborn marks and stains.
- ◆ Do not use harsh abrasive cleaners or sharp metal scrapers to clean the oven door since they can scratch the surface, which may result in shattering of the glass
- ◆ Treat glass door gently.

Oven

- ◆ Always keep your appliance clean. Ensure fats and oils do not accumulate around elements, burners or fans.
- ◆ Always keep the oven dish, baking trays and grill dish inserts clean, as any fat deposits may catch fire.
- ◆ Always wrap your meats in foil or an oven roasting bag to minimise cleaning. Any polyunsaturated fats can leave a varnish-like residue which is very difficult to remove.
- ◆ Always keep the grill dish and grill insert clean, as any fat deposits may catch fire.

Replacement Of The Oven Light Bulb

WARNING!

In order to avoid the possibility of an electric shock ensure that the appliance is disconnected from the power supply before replacing the bulb.

- ◆ Set all control knobs to the position "●"/"0" and disconnect the mains plug
- ◆ Unscrew and wash the lamp cover and then wipe it dry
- ◆ Unscrew the light bulb from the socket, replace the bulb with a new one-a high temperature bulb (300°C) with the following parameters:
 - voltage 230 V
 - power 15 W
 - thread E14.
- ◆ Screw the bulb in, making sure it is properly inserted into the ceramic socket.
- ◆ Screw in the lamp cover.

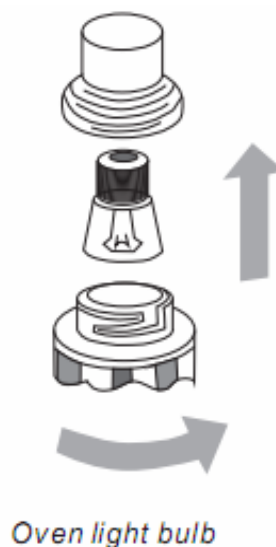

Door Removal

In order to obtain easier access to the oven chamber for cleaning, it is possible to remove the door. To do this, tilt the safety catch part of the hinge upwards. Close the door lightly, lift and pull it out towards you. In order to fit the door back on to the appliance, do the reverse. When fitting, ensure that the notch of the hinge is correctly placed on the protrusion of the hinge holder. After the door is fitted to the oven, the safety catch should be carefully lowered down again. If the safety catch is not set it may cause damage to the hinge when closing the door.

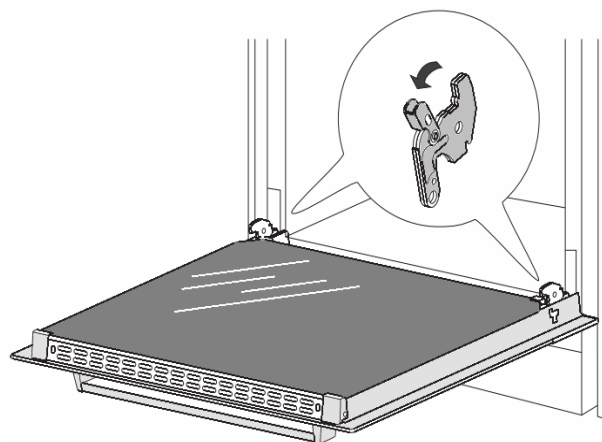

Middle Layer Glass Removal

The oven door is made up of 3 panes of glass and has vents at the top and bottom. When the oven is operating, air is circulated through the door to keep the outer pane cool. If condensation has worked its way in between the glass panes, the door can be dismantled in order to clean in between the panes.

Remove the door as per above instruction and place it on a protective surface (e.g. on a table cloth) to prevent it getting scratched. The door handle should line up with the edge of the table. Make sure the glass lies flat to avoid breakage of glass during cleaning.

1. Undo the 2 screws on upper bracket.
2. Take out upper bracket and first pane of glass.
3. Loosen the 4 clips.
4. Slide out middle pane of glass carefully. Clean the glass panes and other parts with a damp microfibre cloth or a clean sponge and a solution of hot water with a little washing-up liquid. Wipe dry using a soft cloth.

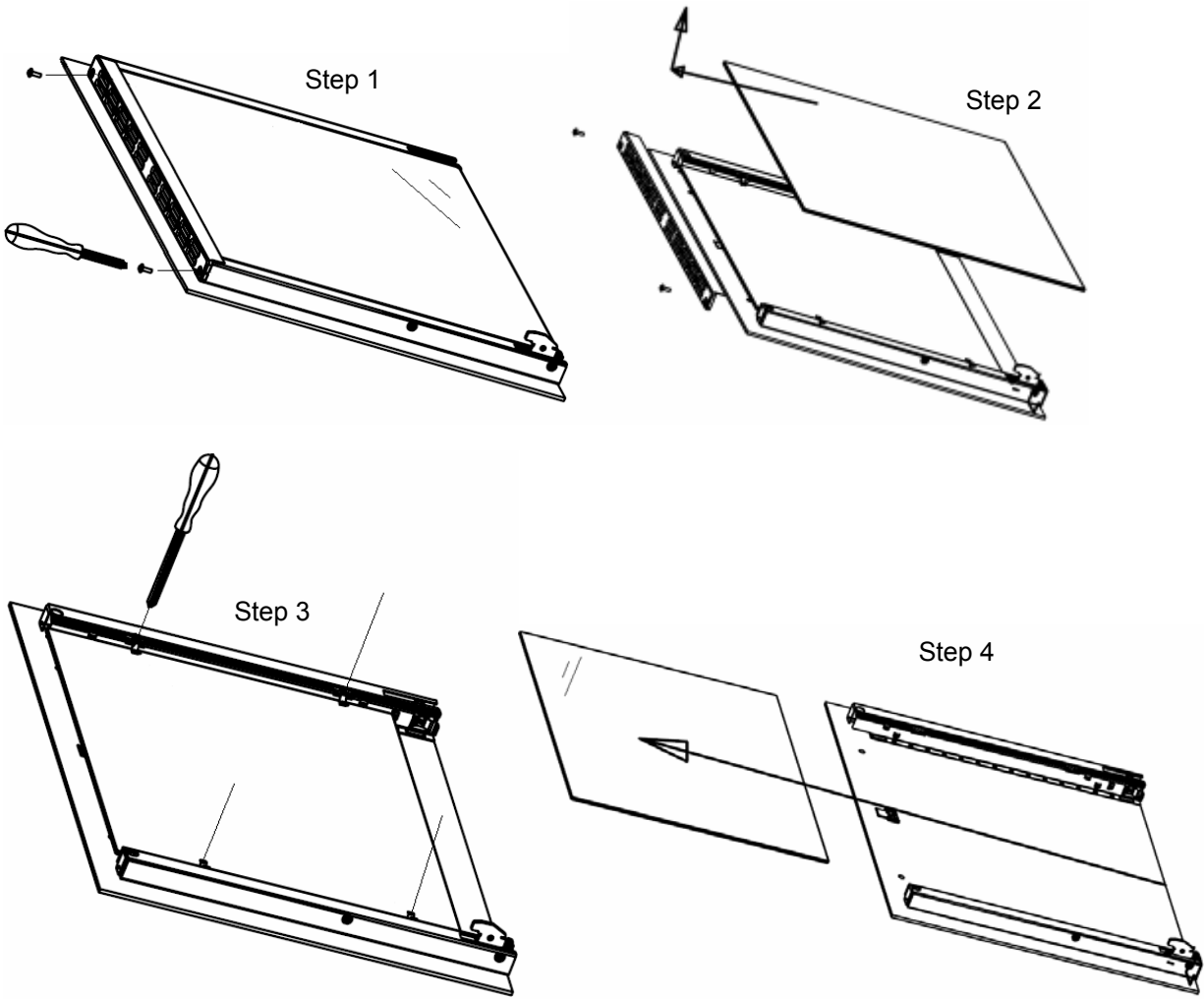

The benefits conferred by this warranty are in addition to all implied warranties, other rights and remedies in respect of the product which the consumer has under the Trade Practices Act and similar State and Territory Laws.

The original purchaser of this Bellini product is provided with the following warranty, subject to the following warranty conditions.

This product is covered by a 2 Year In Home Warranty from the date of purchase. The warranty covers rectification free of charge of any fault arising from defective materials or components, or faulty workmanship. The product will be repaired or replaced at the option of GSM Sales Pty Ltd.

WARRANTY CONDITIONS

1. This warranty is only valid for appliances installed and used according to the manufacturer's instructions.
2. This warranty does not apply to damage caused if your appliance has been dismantled, repaired or serviced by any person other than someone authorised by the Company.
3. If you live outside the service area of the Company or one of its service agents, this warranty does not cover the cost of transport of the appliance for service nor the service agent's traveling costs to and from your home.
4. If you are required to transport the appliance to the Company or its service agent, you must ensure it is securely packed and insured. The Company does not accept any responsibility for loss or damage of the appliance prior to it being received by the Company or its service agent.
5. This warranty does not cover loss, damage or

expense to this appliance caused directly or indirectly by power surges, electrical storm damage or connected to incorrect power supply.

6. The Company (and any company related to the Company) will not be liable for any special, incidental or consequential damages or for loss, damage or expense or for personal injury or loss or destruction of property arising directly or indirectly from the use or inability to use this appliance or any of its parts.
7. Warranty will only be given where proof of purchase is provided, e.g. original invoice.
8. Not designed or warranted for industrial or commercial use (Commercial use applies to shops, offices, schools, factories & workshops etc.).

DO NOT SEND IN THIS WARRANTY

Fill out the following details and file with your purchase invoice.

RETAIN & FILE WITH YOUR RECEIPT

Your Purchase Receipt/Invoice is proof of date of purchase. If you are unable to establish the date of purchase, or if the fault is not covered by this warranty, or if the product is found to be in working order, you will be required to bear all service call charges.

GSM Sales Pty Ltd reserves the right to discontinue items, modify designs and change specifications without incurring obligation.

Whilst every effort is made to ensure that descriptions, specifications and other information in this publication is correct, no warranty is given in respect thereof and the company shall not be liable for any errors therein.

You may not make claim under this warranty unless the defect claimed is due to faulty or defective parts or workmanship. GSM Sales is not liable in the following situations (which are not exhaustive): 1. accident, 2. misuse or abuse including failure to maintain, 3. normal wear and tear, 4. power surges, electrical storm damage or incorrect power supply, 5. incorrect or incomplete installation, 6. incorrect operation and use, 7. any modification to appliance without consent, 8. the appliance is serviced by anyone other than a GSM Sales authorised service agent.

Purchased from: _____

Co. Name: _____

Address: _____

Date of Purchase: _____

NOTE: Consistent with our continuing product development policy, improvements may have been made which render the contents of this package slightly different to that shown.

**FOR WARRANTY SERVICE CALL 1300 373 199 TO
CONNECT YOU TO THE NEAREST AUTHORISED SERVICE
CENTRE**

NOTES:

G | S | M
Gerard Sourcing & Manufacturing
GSM Sales Pty Ltd.

The GSM Sales Pty Ltd. Group of Companies has a policy of continual improvement throughout the product range.
As such the unit contained within may differ slightly from the unit illustrated on the pack.

MADE IN CHINA for the GSM Sales Pty Ltd. Group of Companies
Bellini is a registered trademark of GSM Sales Pty Ltd.

