

# Panasonic®

## Owner's Manual

# Blu-ray Disc™ Home Theater Sound System

Model No. SC-BTT196  
SC-BTT195  
SC-BTT190

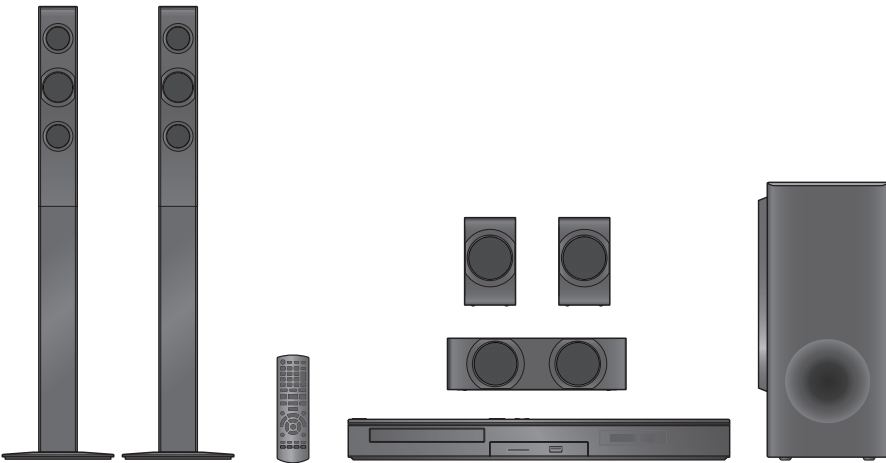

Unless otherwise indicated, illustrations in this Owner's Manual are of SC-BTT196 for U.S.A.

Thank you for purchasing this product.  
For optimum performance and safety, please read these instructions carefully.  
Please keep this manual for future reference.

If you have any questions, contact:  
U.S.A. and Puerto Rico : 1-800-211-PANA(7262)  
Canada : 1-800-561-5505

# IMPORTANT SAFETY INSTRUCTIONS

Read these operating instructions carefully before using the unit. Follow the safety instructions on the unit and the applicable safety instructions listed below. Keep these operating instructions handy for future reference.

- 1 Read these instructions.
- 2 Keep these instructions.
- 3 Heed all warnings.
- 4 Follow all instructions.
- 5 Do not use this apparatus near water.
- 6 Clean only with dry cloth.
- 7 Do not block any ventilation openings. Install in accordance with the manufacturer's instructions.
- 8 Do not install near any heat sources such as radiators, heat registers, stoves, or other apparatus (including amplifiers) that produce heat.
- 9 Do not defeat the safety purpose of the polarized or grounding-type plug. A polarized plug has two blades with one wider than the other. A grounding-type plug has two blades and a third grounding prong. The wide blade or the third prong are provided for your safety. If the provided plug does not fit into your outlet, consult an electrician for replacement of the obsolete outlet.
- 10 Protect the power cord from being walked on or pinched particularly at plugs, convenience receptacles, and the point where they exit from the apparatus.
- 11 Only use attachments/accessories specified by the manufacturer.
- 12 Use only with the cart, stand, tripod, bracket, or table specified by the manufacturer, or sold with the apparatus. When a cart is used, use caution when moving the cart/apparatus combination to avoid injury from tip-over.
- 13 Unplug this apparatus during lightning storms or when unused for long periods of time.
- 14 Refer all servicing to qualified service personnel. Servicing is required when the apparatus has been damaged in any way, such as power-supply cord or plug is damaged, liquid has been spilled or objects have fallen into the apparatus, the apparatus has been exposed to rain or moisture, does not operate normally, or has been dropped.



## WARNING

### Unit

- To reduce the risk of fire, electric shock or product damage,
- Do not expose this unit to rain, moisture, dripping or splashing.
  - Do not place objects filled with liquids, such as vases, on this unit.
  - Use only the recommended accessories.
  - Do not remove covers.
  - Do not repair this unit by yourself. Refer servicing to qualified service personnel.

### AC power supply cord

- Install this unit so that the power cord can be unplugged from the socket outlet immediately if any problem occurs.

### Small object

- Keep the Memory Card out of reach of children to prevent swallowing.
- Keep the screws out of reach of children to prevent swallowing.

## CAUTION

### Unit

- This unit utilizes a laser. Use of controls or adjustments or performance of procedures other than those specified herein may result in hazardous radiation exposure.
- Do not place sources of naked flames, such as lighted candles, on this unit.

### Placement

- To reduce the risk of fire, electric shock or product damage,
- Do not install or place this unit in a bookcase, built-in cabinet or in another confined space. Ensure this unit is well ventilated.
  - Do not obstruct this unit's ventilation openings with newspapers, tablecloths, curtains, and similar items.

### Speaker

#### Use only supplied speakers

- The main unit and supplied speakers are to be used only as indicated in this Owner's Manual. Failure to do so may lead to damage to the amplifier and/or the speakers, and may result in the risk of fire. Consult a qualified service person if damage has occurred or if you experience a sudden change in performance.
- Be careful not to cross (short-circuit) or reverse the polarity of the speaker wires as doing so may damage the speakers.
  - Do not hold the speaker in one hand to avoid injury by dropping the speaker when carrying.
  - You can damage your speakers and shorten their useful life if you play sound at high levels over extended periods.
  - Do not touch the front netted area of the speakers. Hold by the sides.
  - When carrying speakers, hold the stand and base parts.
  - Place speakers on flat, secure surfaces.
  - To avoid injury by falling or dropping the speaker, place the speaker cables with care not to stumble or hook.
  - Do not stand on the base for the speaker. Be cautious when children are near.

### Batteries

Mishandling of batteries can cause electrolyte leakage which can damage items the fluid contacts and may cause a fire.

- Danger of explosion if battery is incorrectly replaced. Replace only with the type recommended by the manufacturer.
- When disposing the batteries, please contact your local authorities or dealer and ask for the correct method of disposal.
- Do not mix old and new batteries or different types at the same time.
- Do not heat or expose to flame.
- Do not leave the battery(ies) in a car exposed to direct sunlight for a long period of time with doors and windows closed.
- Do not take apart or short circuit.
- Do not attempt to recharge alkaline or manganese batteries.
- Do not use batteries if the covering has been peeled off.

Remove batteries if the remote control is not going to be used for a long period of time. Store in a cool, dark place.

CAUTION	- VISIBLE AND INVISIBLE LASER RADIATION WHEN OPEN. DO NOT STARE INTO BEAM. FOR SICHERHETS ÅRSÅG
CAUTION	- CLASS 2 VISIBLE AND INVISIBLE LASER RADIATION WHEN OPEN. DO NOT STARE INTO THE BEAM. IEC60825-1:CLASS 2
ATTENTION	- RAYONNEMENT LASER VISIBLE ET INVISIBLE CLASSE 2. EN CAS D'OUVERTURE, NE PAS REGARDER DANS LE FAISCEAU.
FORSIGTIG	- SYNLIG OG USYNLIG LASERSTRÅLING KLASSE 2. NÅR LÅGET ER ÅBENT, UDGÅ ET SE LIGE IND I STRÅLEN.
VARO	- AVATTAESSA OLET ALTTIINA LUOKAN 2 NÄKYVÄÄ JA NÄKYMÄTÖNÄ LASERSÄTEILYÄ, ÄLÄ TUJOTA SÄTEESEEN.
WARNING	- KLASS 2 SYNLIG OCH OSYNLIG LASERSTRÅLNING NÄR DENNA DEL ÄR ÖPPNAD. STIRRA EJ IN I STRÅLEN.
VORSICHT	- SICHTBARE UND UNSICHTBARE LASERSTRAHLUNG KLASSE 2. WENN ABDECKUNG GEÖFFNET, NICHT IN DEN STRAHL BLICKEN.
注意	- 打开时有可见及不可见激光辐射。避免光束照射。
注意	- ここを開くとクラス2の可視及び不可視レーザー放射が出る。ビームをのぞき込まないこと。 VQL2P54

(Inside of product)

# Table of contents

IMPORTANT SAFETY INSTRUCTIONS .....	2
-------------------------------------	---

---

---

## Getting started

---

---

Package contents and accessories .....	4
Unit and media care .....	5
Playable media .....	6
Control reference guide .....	8
STEP 1: Positioning .....	10
STEP 2: Preparing the speakers .....	11
STEP 3: Connections .....	12
STEP 4: Connecting to an AC power source ....	14
STEP 5: Settings .....	15
•Easy Setting .....	15
•Easy Network Setting .....	15
•Firmware updates .....	16
Inserting or removing media .....	17
Enjoying TV with unit's speakers .....	17
HOME menu .....	18
Multi User Mode .....	19

---

---

## Playback

---

---

Playback .....	20
Using the iPod/iPhone .....	22
•iPod/iPhone Connection .....	22
•iPod/iPhone Playback .....	22

---

---

## TV & Radio

---

---

VIERA Link™	
“HDAVI Control™” .....	23
•Enjoying TV and STB with unit's speakers .....	24
Listening to the Radio .....	25

---

---

## Advanced operations

---

---

Enjoying Network Service (NETFLIX, etc.) .....	26
Home Network feature .....	27
Option menu .....	28
Setup menu .....	31
•Speaker settings .....	36
Enjoying sound effects from all speakers .....	37
Speaker installation option .....	38

---

---

## Reference

---

---

Troubleshooting guide .....	40
Messages .....	43
Specifications .....	45
Supplemental information .....	46
Limited Warranty .....	50
Index .....	Back cover

### • Restriction on use of unauthorized copied content (⇒ 46)



- Please note that the actual controls and components, menu items, etc. may look somewhat different from those shown in the illustrations in this Owner's Manual.

# Package contents and accessories

Check the package contents and supplied accessories before using this unit.

## Package contents

**BTT196** **BTT195**

**Main unit**  
(SA-BTT196/SA-BTT195)



**FRONT**  
(SB-HF185)

(Speakers)

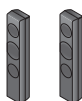

(Stands)

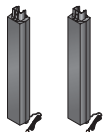

(Bases)



(Screws)



**CENTER**  
(SB-HC190)



(Speaker cable)



**SUBWOOFER**  
(SB-HW190)



**SURROUND**  
(SB-HS190)



**BTT190**

**Main unit**  
(SA-BTT190)



**FRONT**  
(SB-HF190)



(Speaker cables)



**SURROUND**  
(SB-HS190)



**CENTER**  
(SB-HC190)







**SUBWOOFER**  
(SB-HW190)



Parts	Parts number	
	<b>BTT196</b> <b>BTT195</b>	<b>BTT190</b>
Stands (with cables)	RYP1714B-K: RED RYP1714A-K: WHITE	—
Bases	RYP1745-K × 2	—
Screws	XSN5+12FJK × 8	—
Speaker cables	REEX1270: BLUE REEX1269: GRAY REEX1268: GREEN	REEX1267A: WHITE REEX1266A: RED REEX1270: BLUE REEX1269: GRAY REEX1268: GREEN

## Accessories

<input type="checkbox"/> <b>1 Remote control</b> (N2QAYB000727)	<input type="checkbox"/> <b>1 AC power supply cord</b> (K2CB2CB00021)	<input type="checkbox"/> <b>1 FM indoor antenna</b> (RSAX0002)	<input type="checkbox"/> <b>1 Sheet of speaker cable sticker</b>
			
<input type="checkbox"/> <b>2 Batteries for remote control</b>			
			



- Product numbers provided in this Owner's Manual correct as of December 2011. These may be subject to change.
- Do not use AC power supply cord with other equipment.

### For Canada

- The enclosed Canadian French label sheet corresponds to the English display on the unit.

## Unit and media care

### ■ Clean this unit with a soft, dry cloth

- Never use alcohol, paint thinner or benzine to clean this unit.
- Before using chemically treated cloth, carefully read the instructions that came with the cloth.

### ■ This unit's lens

- Use the lens cleaner (not supplied) to clean the unit's lens.

### ■ Clean discs

**DO**

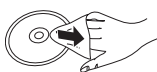

**DO NOT**



Wipe with a damp cloth and then wipe dry.

### ■ Disc and card handling precautions

- Handle discs by the edges to avoid inadvertent scratches or fingerprints on the disc.
- Do not attach labels or stickers to discs.
- Do not use disc cleaning sprays, benzine, thinner, static electricity prevention liquids or any other solvent.
- Clean any dust, water, or foreign matter from the terminals on the rear side of the card.
- Do not use the following discs:





- Discs with exposed adhesive from removed stickers or labels (rented discs, etc).
- Discs that are badly warped or cracked.
- Irregularly shaped discs, such as heart shapes.

### ■ To dispose or transfer this unit

The unit may keep the user settings information in the unit. If you discard this unit either by disposal or transfer, then follow the procedure to return all the settings to the factory presets to delete the user settings. (⇒ 40, "To return all settings to the factory preset.")

The operation history may be recorded in the memory of this unit.

# Playable media

Type	Logo examples	Type detail	Playable contents
<b>BD</b>		<b>BD-Video</b>	Video
		<b>BD-RE</b>	Video, JPEG, MPO
		<b>BD-R</b>	Video, MKV
<b>DVD</b>		<b>DVD-Video</b>	Video
		<b>DVD-R</b> R 4.7	Video, AVCHD, MKV, JPEG, MPO, FLAC, MP3, WAV
		<b>DVD-R DL</b>	
		<b>DVD-RW</b>	Video, AVCHD
		<b>+R/+RW/+R DL</b>	
<b>CD</b>		<b>Music CD</b>	Music [CD-DA]
		<b>CD-R</b> <b>CD-RW</b>	MKV, JPEG, MPO, FLAC, MP3, Music [CD-DA], WAV
<b>SD</b>		<b>SD Memory Card (from 8 MB to 2 GB)</b> <b>SDHC Memory Card (from 4 GB to 32 GB)</b> <b>SDXC Memory Card (48 GB, 64 GB)</b> (Compatible with both mini and micro types)	AVCHD, AVCHD 3D, MP4, MPEG2, JPEG, MPO
<b>USB</b>	—	<b>USB devices</b> (up to 2 TB)	MP4, MPEG, MKV, JPEG, MPO, FLAC, MP3, WAV

- See pages 7 and 46 for more information on the types of content that can be played.

## ■ Discs that cannot be played in this unit

Any other disc that is not specifically supported or previously described.

- DVD-RAM
- Super Audio CD
- Photo CD
- DVD-Audio
- Video CD and Super Video CD
- WMA discs
- All types of DivX discs
- PAL discs
- HD DVD
- BD-Video discs recorded at a rate of 50 fields/sec

## ■ Region management information

### BD-Video

This unit can play BD-Video discs supporting the region code "A".

Example:



### DVD-Video

This unit can play DVD-Video discs supporting the region number "1" or "ALL".

Example:



## ■ Finalize

DVD-R/RW/R DL, +R/+RW/+R DL and CD-R/RW recorded by a recorder, etc. needs to be finalized by the recorder to play on this unit. Please refer to the recorder's instructions.

## ■ BD-Video

This unit supports high bit rate audio (Dolby Digital Plus, Dolby TrueHD, DTS-HD High Resolution Audio and DTS-HD Master Audio) adopted in BD-Video.

## ■ 3D

- 3D videos and 3D still pictures can be played back when this unit is connected to a 3D compatible TV using a High Speed HDMI Cable.
- 2D video can be enjoyed as 3D virtually. (⇒ 31)

## ■ Music CD

- Operation and sound quality of CDs that do not conform to CD-DA specifications (copy control CDs, etc.) cannot be guaranteed.
- The digital audio content side of a DualDisc does not meet the technical specifications of the Compact Disc Digital Audio (CD-DA) format so playback may not be possible.

## ■ SD card

- miniSD Cards, microSD Cards, microSDHC Cards and microSDXC Cards can be used, but must be used with an adaptor card. These are usually supplied with such cards, or otherwise customer provided.
- To protect the card's contents, move the record prevention tab (on the SD card) to "LOCK".
- This unit is compatible with SD Memory Cards that meet SD Card Specifications FAT12 and FAT16 formats, as well as SDHC Memory Cards in FAT32 format and SDXC Memory Cards in exFAT.
- If the SD card is used with incompatible computers or devices, recorded contents may be erased due to the card being formatted etc.
- Usable memory may be slightly less than the card capacity.



## ■ USB device

- This unit does not guarantee connection with all USB devices.
- This unit does not support USB device charging.
- FAT12, FAT16, FAT32 and NTFS file systems are supported.
- This unit supports USB2.0 High Speed.
- This unit supports an HDD formatted in FAT32 and NTFS. If the HDD is not recognized the power to the HDD may not be supplied. Supply power from an external source.



- It may not be possible to play the above media in some cases due to the type of media, the condition of the recording, the recording method and how the files were created.
- The producers of the disc can control how discs are played, so you may not always be able to control play as described in this Owner's Manual. Read the disc's instructions carefully.

# Control reference guide

## Remote control

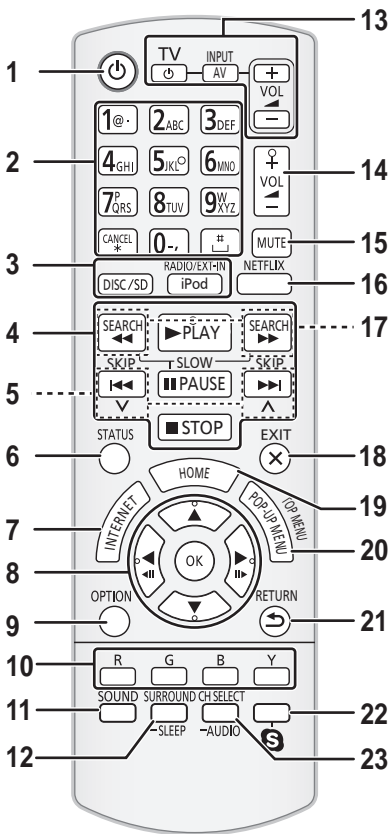

## Using the remote control

Insert so the poles (+ and -) match those in the remote control.

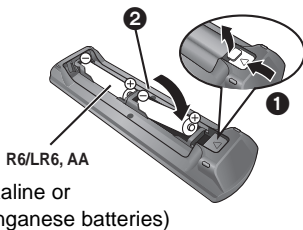

Point it at the remote control signal sensor on this unit. (⇒ 9)

- 1 Turn the unit on and off
- 2 Select title numbers, etc./Enter numbers or characters  
[CANCEL]: Cancel
- 3 Select the source
- 4 Basic playback control buttons (⇒ 20)
- 5 Select preset radio stations (⇒ 25)
- 6 Show status messages (⇒ 20)
- 7 Show the Home screen of the VIERA Connect (⇒ 26)
- 8 [▲, ▼, ◀, ▶]: Move the highlight for selection  
[OK]: Confirm the selection  
(◀▶)(◀▶): Frame-by-frame (⇒ 20)
- 9 Show OPTION menu (⇒ 28)
- 10 Colored buttons  
Used for various purposes depending on the display
- 11 Set the sound mode (⇒ 37)
- 12 Select surround sound effects (⇒ 37)/Set the sleep timer
  - ① Press and hold [-SLEEP].
  - ② While "SLEEP \*\*" is displayed, press [-SLEEP] several times to select the time (in minutes).
    - Timer selection is up to 120 minutes.
    - Select "OFF" when canceling the setting.
    - To confirm the remaining time Press and hold the button again.
- 13 **TV operation buttons**  
[⏻ TV]: Turn the television on and off  
[AV, INPUT]: Switch the input select  
[+ - VOL]: Adjust the volume
- 14 Adjust the volume of the main unit
- 15 Mute the sound
  - "MUTE" flashes on the unit's display, while the function is on.
  - To cancel, press the button again or adjust the volume.
  - Muting is canceled if the unit is turned off.
- 16 Show NETFLIX screen
- 17 Select radio stations manually (⇒ 25)
- 18 Exit the menu screen
- 19 Show HOME menu (⇒ 18)
- 20 Show Pop-up Menu/Top Menu (⇒ 20)
- 21 Return to previous screen
- 22 Start up a video communication (⇒ 26)
- 23 Select speaker channel (⇒ 37)/Select audio (⇒ 20)



## Main unit (Front)

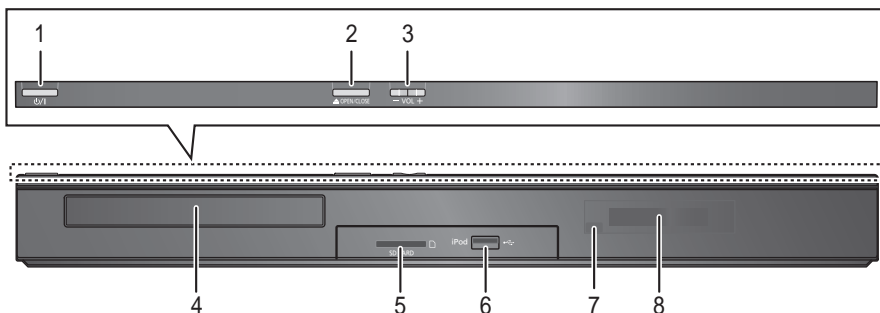

- |   |   |
|---|---|
| <p>1 <b>Standby/on switch</b> [⏻/⏺] (⇒ 15)<br/>Press to switch the unit from on to standby mode or vice versa. In standby mode, the unit is still consuming a small amount of power.</p> <p>2 Open or close the disc tray (⇒ 17)</p> <p>3 Adjust the volume of the main unit</p> <p>4 Disc tray</p> | <p>5 SD card slot (⇒ 17)</p> <p>6 USB port (⇒ 17, 22)</p> <p>7 Remote control signal sensor<br/>Distance: Within approx. 7 m (23 ft.)<br/>Angle: Approx. 20° up and down, 30° left and right</p> <p>8 Display</p> |
|---|---|

## Main unit (Rear)

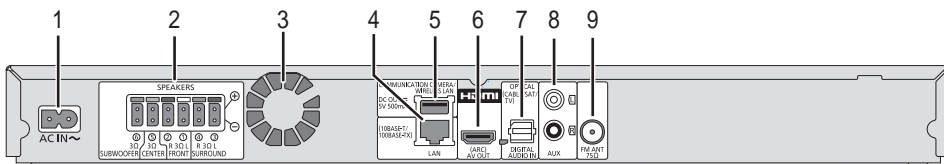

- |   |   |
|---|---|
| <p>1 AC IN terminal (⇒ 14)</p> <p>2 Speaker terminals (⇒ 12)</p> <p>3 Cooling fan</p> <p>4 LAN port (⇒ 14)</p> <p>5 USB port (⇒ 14, 26)</p> | <p>6 HDMI AV OUT (ARC) terminal (⇒ 12)</p> <p>7 DIGITAL AUDIO IN terminal (⇒ 12, 13)</p> <p>8 AUX terminal (⇒ 12)</p> <p>9 FM radio antenna terminal (⇒ 13)</p> |
|---|---|

# STEP 1: Positioning

## For optimum position

Place the front, center and surround speakers at approximately the same distance from the seating position.

- Adjust the volume using the Delay time function if the distance between each speaker and the seating position is not equal. (⇒ 37)

e.g., **BTT196**

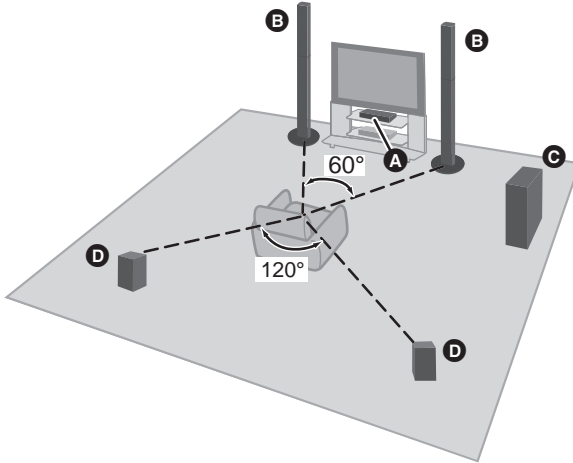

### **A** Center speaker

- Put on a rack or shelf not to interfere with the TV's various sensors (ambient light, etc.). Vibration caused by the speaker can disrupt the picture if it is placed directly on the TV.

### **B** Front speakers

### **C** Subwoofer

### **D** Surround speakers

- Place the speakers at the same height or higher than ear level.



- Keep your speakers at least 10 mm ( $13/32''$ ) away from the system for proper ventilation.
- Placing speakers too close to floors, walls, and corners can result in excessive bass. Cover walls and windows with thick curtains.
- For optional wall mount, refer to page 38.

# STEP 2: Preparing the speakers

## Assembling the front speakers **BTT196** **BTT195**

**1** Attach the stand to the base.

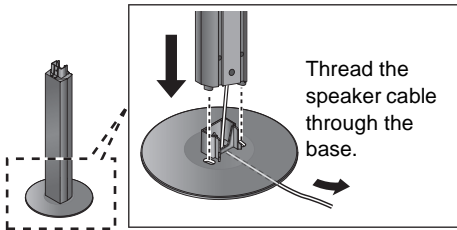

**2** Tighten the 3 screws (supplied) securely.

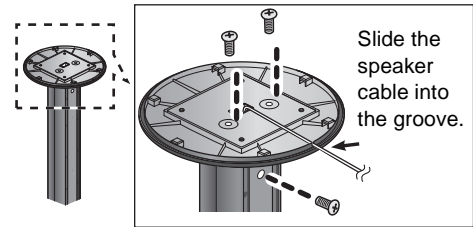

**3** Attach the speaker.

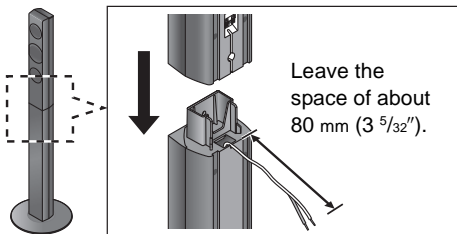

**4** Tighten the screw (supplied) securely.

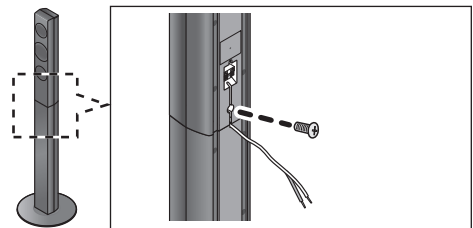

- To prevent damage or scratches, lay down a soft cloth and perform assembly on it.

## Connecting the speaker cables

Attach the speaker cable sticker (supplied) and connect the speaker cables to the speakers. e.g., Surround speaker

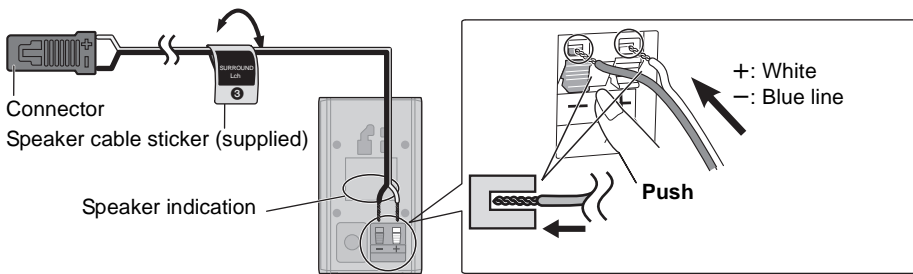

Speaker cable sticker	Connector
FRONT Lch ①	WHITE
FRONT Rch ②	RED
SURROUND Lch ③	BLUE
SURROUND Rch ④	GRAY
CENTER ⑤	GREEN
SUBWOOFER ⑥	PURPLE

# STEP 3: Connections

Turn off all equipment before connection and read the appropriate owner's manual.  
Do not connect the AC power supply cord until all other connections are complete.

## Speaker connection

Connect the speaker cables to the terminals of the same color.

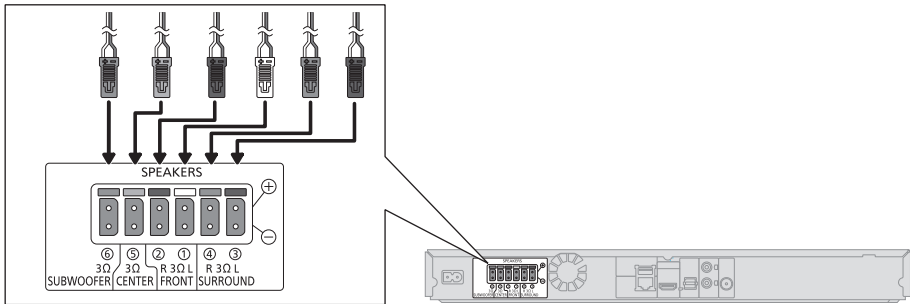

## Connection to a TV

### HDMI

- Use the High Speed HDMI cables. Non-HDMI-compliant cables cannot be utilized.  
It is recommended that you use Panasonic's HDMI cable. When outputting 1080p signal, please use HDMI cables 5.0 meters (16.4 ft.) or less.

Recommended part number (High Speed HDMI Cable):

RP-CDHS15 (1.5 m/4.9 ft.), RP-CDHS30 (3.0 m/9.8 ft.), RP-CDHS50 (5.0 m/16.4 ft.), etc.

- Audio will be output through the system's speakers when "Off" is selected in "HDMI Audio Output". (⇒ 33)

### TV Audio

- To output TV audio from this unit's speakers, you need to switch the selector. (⇒ 17)

### OPTICAL IN

- After making the digital audio connection, make settings to suit the type of audio from your digital equipment. (⇒ 33)

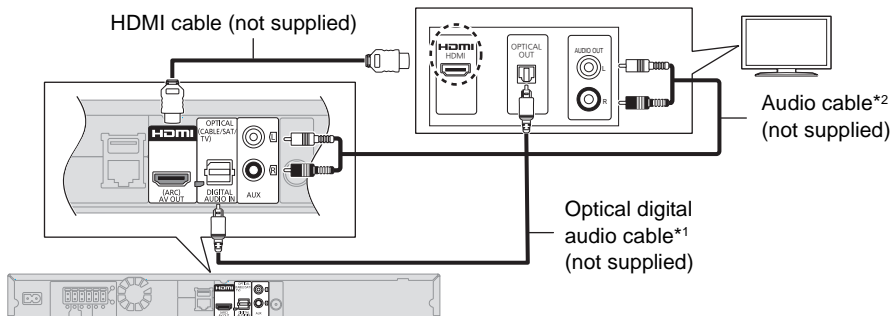

\*1 If the HDMI terminal on the TV is labeled "HDMI (ARC)", the connection of the optical digital audio cable is not required.

\*2 It is also possible to use an audio cable instead of the optical digital audio cable. In this case, connect the AUX terminal on the main unit with the audio output terminal on the TV.

### What is ARC?

ARC is an abbreviation of Audio Return Channel, also known as HDMI ARC. This feature allows a home theater system to receive and play audio from the TV through a signal HDMI cable without additional wiring.

## FM antenna connection

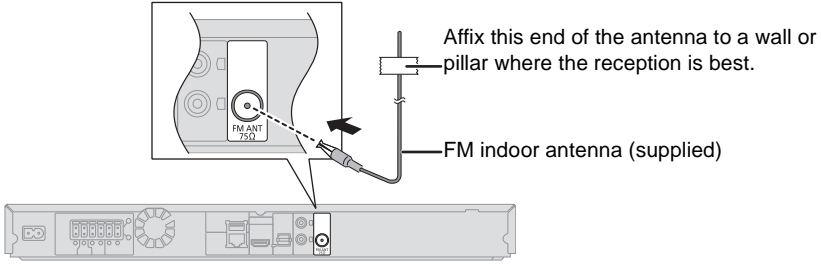

- Use an FM outdoor antenna if radio reception is poor.

## Other device connection

e.g.,

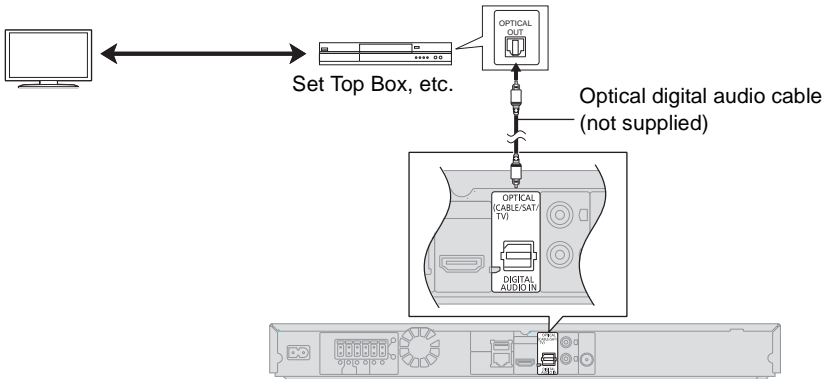

## Connection to the network

The following services can be used when this unit is connected to broadband.

- Firmware can be updated (⇒ 16)
- You can enjoy BD-Live (⇒ 21)
- You can enjoy VIERA Connect (⇒ 26)
- You can access other devices (Home Network) (⇒ 27)

For details about connection method, refer to the instructions supplied with the connected equipment.

### Wireless LAN connection

- Connect the Wireless LAN Adaptor DY-WL5 (optional). Only DY-WL5 can be used. Read the operating instructions for DY-WL5 thoroughly when using it.

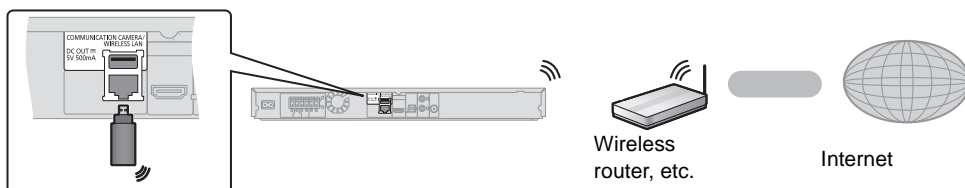

- For up-to-date compatibility information on your wireless router refer to <http://panasonic.jp/support/global/cs/> (This site is in English only.)  
For additional information about this unit refer to <http://www.panasonic.com/consumer/support> (For U.S.A.)
- The unit is not compatible with public wireless LAN services provided in airports, stations, cafes etc.

### LAN cable connection

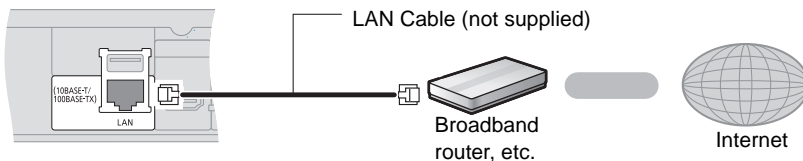

- Use category 5 or above straight LAN cables (STP) when connecting to peripheral devices.
- Inserting any cable other than a LAN cable in the LAN terminal can damage the unit.

## STEP 4: Connecting to an AC power source

Connect only after all other connections are complete.

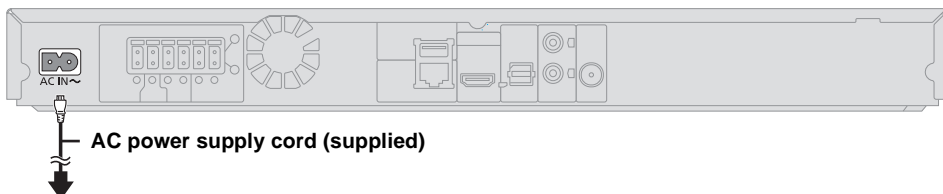

### To a household AC outlet

- This unit consumes a small amount of AC power (⇒ 45) even when turned off. In the interest of power conservation, if you will not be using this unit for an extended period of time, it can be disconnected.

# STEP 5: Settings

## Easy Setting

After connecting your new home theater for the first time and pressing [⏻], a screen for the basic settings will appear.

### Preparation

Turn on the television and select the appropriate video input on the television.

#### 1 Press [⏻].

Setup screen appears.

#### 2 Follow the on-screen instructions and apply the settings.



- You can perform this setup anytime by selecting "Easy Setting" in the Setup menu. (⇒ 35)
- If this unit is connected to a Panasonic TV (VIERA) supporting HDAVI Control 2 or later via an HDMI cable, then setting information on the TV such as "On-screen Language" is acquired by this unit.

## Easy Network Setting

After completing "Easy Setting", you can perform "Easy Network Setting".

### Wired connection

Select "Wired" and press [OK].

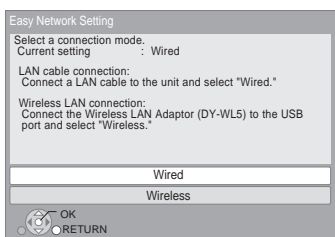

Follow the on-screen instructions to apply your connection settings.

### Wireless connection

#### Preparation

- Obtain your network name (⇒ 16, SSID).
- If your wireless connection is encrypted, please be sure that you know your encryption key (password).
- If "Wireless LAN Adaptor is not connected." is displayed, check that the Wireless LAN Adaptor

is fully inserted. Alternatively, disconnect and reconnect it. If there is still no change in the display, consult your dealer for advice.

#### 1 Select "Wireless" and press [OK].

#### 2 Select "Search for wireless network" or "WPS (PUSH button method)" and press [OK], then follow the on-screen instructions and apply the settings.

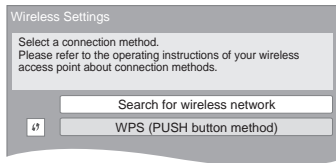

#### ■ "WPS (PUSH button method)"

If you are using a wireless router that supports WPS (Wi-Fi Protected Setup™), you can easily perform the settings.

#### ■ "Search for wireless network"

The available wireless networks will be displayed.

##### ① Select your network name and press [OK].

- If your network name is not displayed, search again by pressing the [R] button on the remote control. Stealth SSID will not be displayed, in this case enter manually.

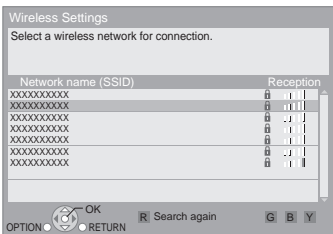

#### When your wireless network is encrypted

##### ② Press [OK] to select "Encryption Key".

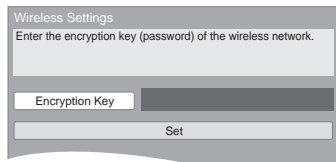

- ③ Enter your encryption key (password).

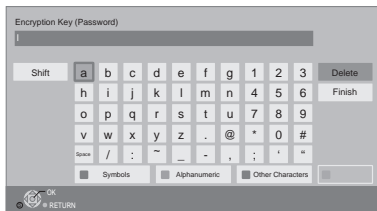

## To enter your network name (SSID) manually

If your network name (SSID) is not displayed in step ①, follow these steps.

- To display the network name (SSID) input screen:  
Press [HOME] ⇒ select "Others" ⇒ [OK] ⇒ select "Setup" ⇒ [OK] ⇒ select "Network" ⇒ [OK] ⇒ select "Network Settings" ⇒ [OK] ⇒ select "Wireless Settings" ⇒ [OK] ⇒ select "Connection Setting" ⇒ [OK] ⇒ select "Manual setting" ⇒ [OK]
- Press [OK] to select "SSID" and enter your SSID.

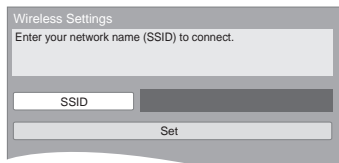

- If your wireless network is encrypted, go to step ②.



- Refer to the operating instructions of the hub or router.
- WPS (Wi-Fi Protected Setup) is a standard that facilitates settings relating to the connection and security of wireless LAN devices. To see whether your wireless router supports WPS, check the wireless router operating instructions.
- You can perform this setup anytime by selecting "Easy Network Setting" in the Setup menu. (⇒ 34)
- You can redo these settings individually using "Network Settings". (⇒ 34)
- Do not use this unit to connect to any wireless network for which you do not have usage rights.  
During automatic searches in a wireless network environment, wireless networks (SSID\*) for which you do not have usage rights may be displayed; however, using these networks may be regarded as illegal access.
- After performing network settings on this unit, the settings (encryption level, etc.) of the wireless router might change. When you have trouble getting online on your PC, perform the network settings on your PC in accordance with the settings of the wireless router.
- Please be aware that connecting to a network without encryption may result in the content of the communication being illegitimately viewed by a third party, or the leaking of data such as personal or secret information.

\* SSID:

An SSID (Service Set Identification) is a name used by wireless LAN to identify a particular network. Transmission is possible if the SSID matches for both devices.

## Reprogramming the remote control

If you have more than one Panasonic products and the remote control operates both products at once, you will need to change the remote control code to prevent this occurrence. (⇒ 36, "Remote Control Code")

## Firmware updates

Occasionally, Panasonic may release updated firmware for this unit that may add or improve the way a feature operates. These updates are available free of charge.

This unit is capable of checking the firmware automatically when connected to the Internet via a broadband connection.

When a new firmware version is available, the following message is displayed.

New firmware is available.  
Please update firmware in Setup.

To update the firmware

Press [HOME] ⇒ select "Others" ⇒ [OK] ⇒ select "Setup" ⇒ [OK] ⇒ select "System" ⇒ [OK] ⇒ select "Firmware Update" ⇒ [OK] ⇒ select "Update Now" ⇒ [OK]

DO NOT DISCONNECT the unit from the AC power or perform any operation while the update takes place.

After the firmware is installed, "FINISH" will be displayed on the unit's display. Unit will restart and the following screen will be displayed.

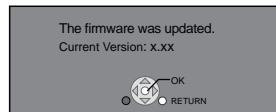

- If downloading on this unit fails or this unit is not connected to the Internet, then you can download the latest firmware from the following website and burn it to a CD-R to update the firmware.  
<http://panasonic.jp/support/global/cs/>  
(This site is in English only.)  
To show the firmware version on this unit.  
(⇒ 36, "Firmware Version Information")
- Downloading will require several minutes. It may take longer or may not work properly depending on the connection environment.
- If you do not want to check for the latest firmware version, set "Automatic Update Check" to "Off". (⇒ 36)



## Inserting or removing media

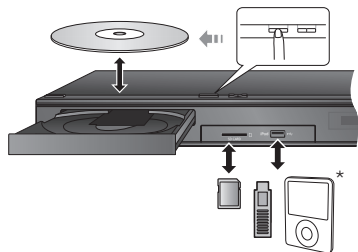

\* (For details ⇒ 22)

- When inserting a media item, ensure that it is facing the right way up.
- When removing the SD card, press the center of the card and pull it straight out.
- If you connect a Panasonic product with a USB connection cable, the setup screen may be displayed on the connected equipment. For details, refer to the instructions for the connected equipment.
- Use the front USB port when you connect a iPod/iPhone, USB memory or a USB HDD. The USB port on the rear panel is for the Communication Camera and the Wireless LAN Adaptor DY-WL5 (optional).

## Enjoying TV with unit's speakers

- 1 Connect the TV and the main unit. (⇒ 12)
- 2 Press [EXT-IN] several times to select the appropriate external input mode. (⇒ 18)
  - Reduce the volume on the TV to its minimum, and then adjust the volume of the main unit.

### Selecting the type of audio

- 1 Press and hold [–AUDIO] to activate the audio setting mode.
- 2 Press [–AUDIO] several times to select the audio. (MAIN, SAP)
  - Set "PCM-FIX" (⇒ 33) to "Off".
  - "SAP" (Secondary Audio Program) only works with Dolby Dual Mono.



- You cannot change the audio type when the TV is connected to this unit via the AUX terminal.

# HOME menu

Major functions of this unit can be operated from the HOME menu.

## Preparation

Turn on the television and select the appropriate video input on the television.

- 1 Press [POWER] to turn on the unit.
- 2 Press [OK] or [▲, ▼, ◀, ▶] to select the item.
  - If there are any other items, repeat this step.



## EXT IN

When you want to output audio of an external device from this unit, select the name of the terminal to which you have connected the device.

<b>AUX</b>	AUX terminal
<b>ARC</b>	HDMI AV OUT (ARC) terminal
<b>DIGITAL IN</b>	DIGITAL AUDIO IN terminal

If audio output from a TV or STB is selected, "(TV)" or "(CABLE/SATELLITE)" is displayed. (⇒ 33)

## Network

<b>Network Service</b>	Displays the Home screen of VIERA Connect. (⇒ 26)
<b>Home Network</b>	<b>DLNA Client</b> (⇒ 27)
	<b>Media Renderer</b> (⇒ 27)

## FM Radio

To enjoy the FM radio (⇒ 25)

## Videos/Photos/Music

<b>Disc</b>	Play back the contents. (⇒ 20)
<b>SD Card</b>	<ul style="list-style-type: none"> <li>• When multiple contents are recorded, select the types of contents or the title.</li> </ul>
<b>USB</b>	

## Sound

Select sound quality (equalizer). (⇒ 30)

## iPod

To enjoy Music (⇒ 22)

## Others

<b>Setup</b>	(⇒ 31)
<b>SD Card Management</b>	(⇒ 21)
<b>Wallpaper</b>	Changes the background of HOME menu.

## To show the HOME menu

Press [HOME].



- Items to be displayed may vary with the media.
- When the selector is switched, it may take time to play back the selected video and/or audio.
- To save on electricity, the power is turned off automatically if there is no button operation for about 30 minutes when not playing back (such as when paused, displaying the menu, displaying still pictures, etc.). (Compatible with ENERGY STAR)

## Multi User Mode

Multi User Mode is a function that enables switching of multiple settings easily. Up to 4 people can use the unit with their own settings.

The following settings can be personalized.

- The user icon
- The wallpaper of Home menu
- The audio and picture settings (⇒ 28, 31)

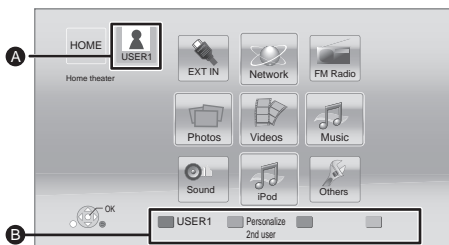

- A** The user name and icon currently selected  
**B** Personalize a new user and switch the users with colored buttons.

### Personalizing a new user

- 1 Press [HOME].
- 2 Press a colored button that indicates new user personalization.
- 3 Select an item and change the settings according to the indications.  
The following items can be set.

<b>Input Nickname</b>	Personalize a user name.
<b>Select Icon</b>	Personalize a user icon. <b>Select from illustrations</b> The image can be selected from prepared illustrations. <b>Create from Photos</b> If the Communication camera is connected, you can shoot and personalize your photo. <ul style="list-style-type: none"> <li>• You can also select a photo in recording media as an icon. (⇒ 28, "Icon Personalization")</li> </ul>

<b>Select Wallpaper</b>	Personalize a background of the Home menu. <ul style="list-style-type: none"> <li>• Other than prepared wallpapers, you can also select a photo in recording media as an wallpaper. (⇒ 28, "Wallpaper")</li> </ul>
<b>Personalize Smartphone</b>	Smartphone used as a remote control can be registered with respect to each user. <ul style="list-style-type: none"> <li>• Multiple users cannot be registered for one smartphone.</li> </ul>

- 4 Select "Confirm" and press [OK].

To change the personalized user information Select "Edit User Information" from Setup menu. (⇒ 36)

### Switching the user

#### Using colored buttons

Press the colored buttons in the Home menu to switch to the user corresponding to the button.

#### Using facial recognition

(Only when connected to Communication Camera ⇒ 26)

- 1 Press [OPTION] in the Home menu.
- 2 Select "Facial Recognition" and press [OK].
- 3 Turn the face to Communication Camera.

The camera determines the closest face from the face pictures of the personalized users and displays the results.

- 4 Press [OK].

- To redo the facial recognition, press [RETURN].

#### Using registered smartphones

When the unit is turned on using the registered smartphone, the user who registered the smartphone will automatically be selected.

- Perform the "Remote Device Settings". (⇒ 34)



- To use smartphones as a remote control, installation of dedicated software is required. For more details, refer to the following website.  
<http://panasonic.jp/support/global/cs/>  
 (This site is in English only.)

# Playback

## 1 Insert the media.

Playback starts depending on the media.

## 2 Select the item to play and press [OK].

Repeat this procedure if necessary.



- DISCS CONTINUE TO ROTATE WHILE MENUS ARE DISPLAYED. Press [■STOP] when you have finished playback to protect the unit's motor, your television screen and so on.
- MKV: Successive play is not possible.
- It is not possible to play back AVCHD and MPEG2 video which have been dragged and dropped, copied and pasted to the media.

## Operations during playback

Following functions may not work depending on the media and contents.

### Stop

Press [■STOP].

The stopped position is memorized.

### Resume play function

Press [▶PLAY] to restart from this position.

- The position is cleared if the tray is opened or you press [■STOP] several times to display "STOP" on the unit's display.
- On BD-Video discs including BD-J, the resume play function does not work.

### Pause

Press [⏸PAUSE].

- Press [⏸PAUSE] again or [▶PLAY] to restart play.

### Search/Slow-motion

#### Search

While playing, press [SEARCH◀◀] or [SEARCH▶▶].

- Music and MP3: The speed is fixed to a single step.

#### Slow-motion

While paused, press [SEARCH◀◀] or [SEARCH▶▶].

- BD-Video and AVCHD: [SEARCH▶▶] only.

The speed increases up to 5 steps.

- Press [▶PLAY] to revert to normal playback speed.

### Skip

While playing or paused, press [◀◀] or [▶▶].  
Skip to the title, chapter or track.

## Frame-by-frame

While paused, press [◀] (◀◀) or [▶] (▶▶).

- Press and hold to change in succession forward or backward.
- Press [▶PLAY] to revert to normal playback speed.
- BD-Video and AVCHD: [▶] (▶▶) only.

## Changing audio

Press and hold [–AUDIO] to activate the audio setting mode.

You can change the audio channel number or soundtrack language, etc.

## Displaying menus and playback information

### Show top menu/pop-up menu

Press [POP-UP MENU/TOP MENU].

- Select the item and press [OK].

### Show the status messages

While playing, press [STATUS].

The status messages give you information about what is currently being played. Each time you press [STATUS], the display information may change or will disappear from the screen.

- Depending on media and contents, the display may change or may not appear.

e.g., BD-Video



- A** T: Title, C: Chapter, PL: Playlist
- B** Elapsed time in the title
- C** Current position
- D** Total time

e.g., JPEG



## Enjoying 3D video and photos

### Preparation

Connect 3D compatible TV to an HDMI AV OUT terminal of this unit using a High Speed HDMI Cable. (⇒ 12)

- Perform the necessary preparations for the TV.
- Play back following the instructions displayed on the screen.
- 3D Settings (⇒ 31, 33)



- Please refrain from viewing 3D images if you do not feel well or are experiencing visual fatigue. In the event that you experience dizziness, nausea, or other discomfort while viewing 3D images, discontinue use and rest your eyes.
- 3D images may not output as settings of "HDMI Resolution" and "24p Output". (⇒ 32)
- When playing back 3D photos from "Photos" screen, select from the "3D" list. (Still pictures in "2D" are played back in 2D.) If "2D" and "3D" indications are not displayed, press [R] to switch the view of playback contents.

## Enjoying BD-Live

With "BD-Live" discs, you can enjoy bonus contents that use Internet access.

For this BD-Live function, insertion of an SD card is necessary along with Internet connection.

- 1 Perform network connection and settings.**  
(⇒ 14, 15)
- 2 Insert an SD card with 1 GB or more free space.**
  - The SD card is used as the local storage.
- 3 Insert the disc.**

### ■ Deleting data/Formatting SD cards

Select "SD Card Management" in the Home menu (⇒ 18), then select "BD-Video Data Erase" or "Format SD Card" and press [OK].



- The usable functions and the operating method may vary with each disc, please refer to the instructions on the disc and/or visit their website.
- "BD-Live Internet Access" may need to be changed for certain discs (⇒ 35).

## Slideshow

Play a slideshow of photos and make various settings during the playback.

- 1 Insert the media.**
- 2 Select "Photos".**
- 3 Select an item and press [G].**

The following items can be set.

<b>Start Slideshow</b>	Start the slideshow. You can display still pictures in the selected folder one by one at a constant interval.
<b>Display Interval</b>	Change the display interval.
<b>Transition Effect</b>	Select the effect when sliding pictures.
<b>Repeat Play</b>	Set whether to repeat the slideshow.
<b>Soundtrack</b>	Set whether to play background music. <ul style="list-style-type: none"><li>• You can select the soundtrack from USB device, Music CD and iPod/iPhone.</li><li>• Some media cannot be selected as the source depending on the case.</li></ul>
<b>Soundtrack Folder</b>	Select the folder from which the music files are played.
<b>Random Soundtrack</b>	Background music is played in random order.



- Still pictures displayed as "⊗" cannot be played back with this unit.
- When a music CD, a USB device with music recorded, and an iPod/iPhone are inserted/connected to this unit, iPod/iPhone has priority to played back as background music.

# Using the iPod/iPhone

## Compatible iPod/iPhone (as of December 2011)

- Update your iPod/iPhone with the latest software before using this unit.
- Compatibility depends on the software version of your iPod/iPhone.
- iPod/iPhone compatibility assures music playback and battery charge functions of this unit as a home theater system.

<b>iPod touch:</b> 1st, 2nd, 3rd, and 4th generation
<b>iPod nano:</b> 1st, 2nd, 3rd, 4th, 5th, and 6th generation
<b>iPod classic</b>
<b>iPod:</b> 5th generation
<b>iPhone 4S/ iPhone 4 / iPhone 3GS / iPhone 3G/ iPhone</b>



- In some locations, reception status of an iPhone may be poor when it is loaded on this unit.
- When the iPhone receives a call while connected to this unit, playback, etc. of the iPhone may stop. To prioritize the operation with the iPhone connected to this unit, make the setting so that the iPhone does not receive calls.
- Avoid using Wi-Fi mode on your iPhone while the network functions on this unit are in use wirelessly.

### About recharging the battery

- iPod/iPhone will not be recharged after the battery charge completion.
- iPod/iPhone will start recharging when this unit is on.

## iPod/iPhone Connection

### Preparation

- Turn the main unit off or reduce the volume of the main unit to its minimum.

### 1 Connect the iPod/iPhone.

To purchase a Dock Connector to USB Cable, consult your iPod/iPhone dealer.

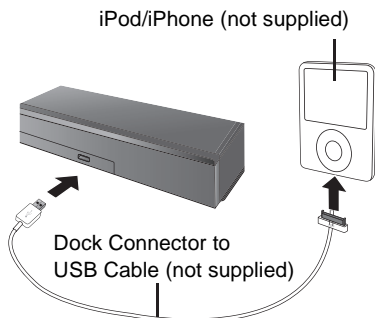

## iPod/iPhone Playback

- 1 Press [HOME].
- 2 Select "iPod" and press [OK].
- 3 Select the item to play.
  - Repeat this procedure if necessary.

### Album artwork

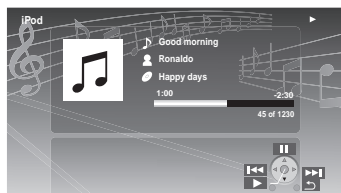

- If album artwork is not contained in the data, "♪" will appear on TV.
- Depending on the software version of your iPod/iPhone, the album artwork may not appear properly.
- Some operations may not work while reading the album artwork.

- The setting of the playback mode will be kept until changes are made on the same iPod/iPhone.
- Surround sound effect and sound mode are available.

# VIERA Link™

## “HDAVI Control™”

### What is VIERA Link “HDAVI Control”?

VIERA Link™ is a new name for EZ Sync™. VIERA Link “HDAVI Control” is a convenient function which will link the operations of this unit and a Panasonic TV (VIERA) under “HDAVI Control”. You can use this function by connecting the equipment with an HDMI cable. See the operating instructions for connected equipment for operational details.

### Preparation

- ① Set “VIERA Link” to “On” (⇒ 35).  
(The default setting is “On”.)
- ② Set the “HDAVI Control” operations on the connected equipment (e.g., TV).
- ③ Turn on all “HDAVI Control” compatible equipment and select this unit’s input channel on the connected TV so that the “HDAVI Control” function works properly.

**Also when the connection or settings are changed, repeat this procedure.**

### Automatic input switching Power on link

When the following operations are performed, the input channel of the television will be automatically switched and the screen of this unit will be displayed.

When the television is off, the television will automatically turn on.

- When play starts on the unit
- When an action that uses the display screen is performed  
(e.g., Home menu)
- This function does not work when the iPod/iPhone selector is chosen. (⇒ 22)

### Power Off link

All connected equipment compatible with “HDAVI Control”, including this unit, automatically turns off when you switch the television off.

### Playing music continuously even after turning off power to the television

When the unit is connected to a Panasonic TV (VIERA) that supports HDAVI Control 2 or later. Select “Video” in “Power Off link” (⇒ 35)

### Easy control only with VIERA remote control

#### Only when TV supports “HDAVI Control 2” or later

By using the TV remote control, you can perform various playback operations and settings.

See the operating instructions of the TV for more details.



- The buttons that you can use for this unit vary depending on the TV. For details, refer to the operating instructions for the TV.
- The operation of this unit may be interrupted when you press certain buttons on the TV remote control.
- This unit supports “HDAVI Control 5” function. “HDAVI Control 5” is the newest standard (current as of November, 2011) for Panasonic’s HDAVI Control compatible equipment. This standard is compatible with Panasonic’s conventional HDAVI equipment.
- VIERA Link “HDAVI Control”, based on the control functions provided by HDMI which is an industry standard known as HDMI CEC (Consumer Electronics Control), is a unique function that we have developed and added. As such, its operation with other manufacturers’ equipment that supports HDMI CEC cannot be guaranteed.
- Please refer to individual manuals for other manufacturers’ equipment supporting VIERA Link function.

## Enjoying TV and STB with unit's speakers

You can select whether audio is output from the unit's speakers or the TV speakers by using the TV menu settings. Switch the audio output setting of the TV to this unit's speakers.

### Select the TV audio

When the TV is turned on, this unit will also automatically turn on.

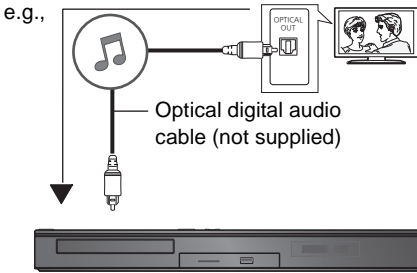

- ① Press [HOME].
- ② Press [▲, ▼, ◀, ▶] to select "Others" and press [OK].
- ③ Press [◀, ▶] to select "Setup" and press [OK].
- ④ Press [▲, ▼] to select "Audio" and press [OK].
- ⑤ Press [▲, ▼] to select "TV Audio Input" and press [OK].
- ⑥ Press [▲, ▼] to switch "AUX", "ARC" or "DIGITAL IN" and press [OK].
  - Select an audio input terminal connected to the unit.



- For details, refer to the operating instructions of the TV.

## Select the STB audio

When the STB power is turned on, this unit and the TV will automatically turn on. The video is output from the TV, and the audio is output from the speakers of this unit.

### Connecting the optical digital audio cable

- When this unit and the STB are connected by an optical digital audio cable, the settings below are required to enable output of audio from the speakers of this unit.

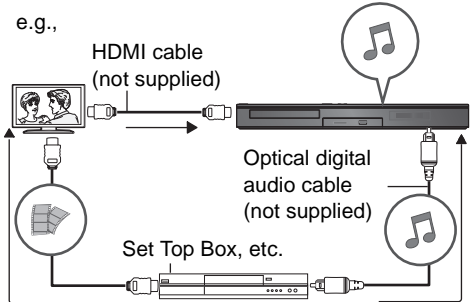

- ① Press [EXT-IN] to select "D-IN".
- ② Press [STATUS] to select "CABLE/SATELLITE AUDIO ON".

Set to "CABLE/SATELLITE AUDIO OFF" when this unit and the STB are not connected by an optical digital audio cable.



# Listening to the Radio

You can preset up to 30 channels.

## Preparation

Make sure that the FM antenna is connected.  
(⇒ 13)

## Presetting stations automatically

- 1 Press [RADIO] to select "FM".
- 2 Press and hold [STATUS] to select "LOWEST" or "CURRENT".

### LOWEST:

To begin auto preset with the lowest frequency (FM87.9).

### CURRENT:

To begin auto preset with the current frequency.\*

\* To change the frequency, refer to "Manual tuning and presetting".

- 3 Press and hold [OK].

Release the button when "AUTO" is displayed.

The tuner starts to preset all the stations it can receive into the channels in ascending order.

## Listening to a preset channel

- 1 Press [RADIO] to select "FM".
- 2 Press the number buttons to select the channel.

To select a 1-digit number

e.g., 1: [1] ⇒ [OK].

To select a 2-digit number

e.g., 12: [1] ⇒ [2].

Alternatively, press [∧, ∨] or [▲, ▼].

## Manual tuning and presetting

Select a radio broadcast.

- ① Press [RADIO] to select "FM".
  - ② Press [SEARCH◀◀] or [SEARCH▶▶] to select the frequency.
- To start automatic tuning, press and hold [SEARCH◀◀], [SEARCH▶▶] until the frequency starts scrolling. Tuning stops when a station is found.

To preset the channel

- ③ While listening to the radio broadcast Press [OK].
- ④ While "P" is flashing on the display Press the number buttons to select the channel.



- A station previously stored is overwritten when another station is stored in the same channel preset.
- The radio settings will be shown on the unit's display. (Some settings are also indicated on the TV screen.)

# Enjoying Network Service (NETFLIX, etc.)

You can access information services from the VIERA Connect Home screen via the Internet.

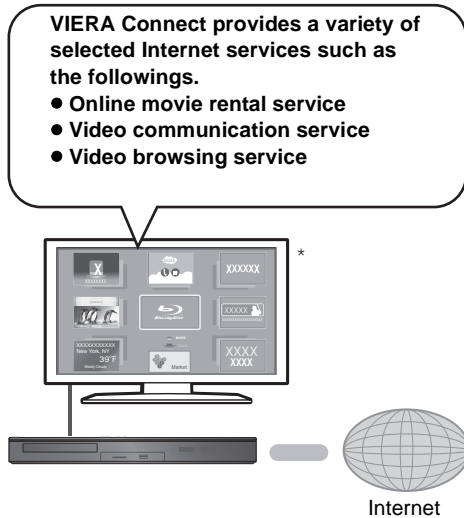

\* Images are for illustration purposes, contents may change without notice.

## Preparation

- Network connection (⇒ 14)
- Network setting (⇒ 15)

## To enjoy video communication (ex. Skype™) :

- Connect this unit with optional Communication Camera (TY-CC20W or TY-CC10W). Depending on your location, this optional camera may not be available. Please consult your local Panasonic dealer for advice.

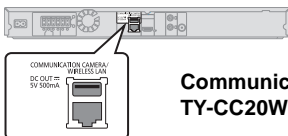

**Communication Camera  
TY-CC20W or TY-CC10W**

- When this unit is connected by wireless LAN connection, connect the Communication Camera via the USB port on the front of this unit.
- For operating method refer to the following website.  
<http://panasonic.jp/support/global/cs/>  
(This site is in English only.)

## 1 Press [INTERNET].

- The video communication service can be accessed directly by pressing [S] button, and NETFLIX can be accessed directly by pressing [NETFLIX] button.

## 2 Select the item and press [OK].

### To exit from VIERA Connect

Press [EXIT], [HOME] or [POP-UP MENU/TOP MENU].



- When playing content in the media, VIERA Connect cannot be accessed by pressing [INTERNET].
- In the following cases, settings are possible using the Setup menu items.
  - When restricting the use of VIERA Connect (⇒ 35, "Network Service Lock")
  - When the audio is distorted (⇒ 34, "Audio Auto Gain Control")
  - When wrong time is displayed (⇒ 34, "Time Zone", "DST")
- If using slow Internet connection, the video may not be displayed correctly. A high-speed Internet service with a speed of at least 6 Mbps is recommended.
- Be sure to update the firmware when a firmware update notice is displayed on the screen. If the firmware is not updated, you will not be able to use the VIERA Connect function. (⇒ 16)
- VIERA Connect Home screen is subject to change without notice.
- The services through VIERA Connect are operated by their respective service providers, and service may be discontinued either temporarily or permanently without notice. Therefore, Panasonic will make no warranty for the content or the continuity of the services.
- All features of websites or content of the service may not be available.
- Some content may be inappropriate for some viewers.
- Some content may only be available for specific countries and may be presented in specific languages.

# Home Network feature

## Playing back contents on the DLNA server

You can share photos, videos and music stored in the DLNA Certified media server (PC with Windows 7 installed, smartphone, etc.) connected to your home network, and enjoy the contents with this home theater.

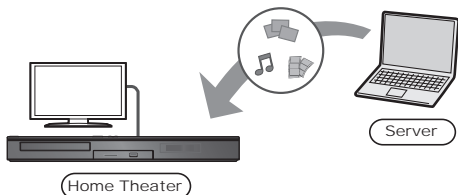

### Preparation

- ① Perform network connection (⇒ 14) and network settings (⇒ 15) of this unit.
- ② Perform Home Network settings of the connected equipment.
- ③ Add the contents and folder to the libraries of the Windows Media® Player or the smartphone, etc.
  - Playlist of Windows Media® Player can play back only the contents that are stored in the libraries.

- 1 Press [HOME].**
- 2 Select “Network”.**
- 3 Select “Home Network”.**
- 4 Select “DLNA Client”.**
  - The list can be updated by pressing [R] on the remote control.
- 5 Select the equipment and press [OK].**
- 6 Select the item to play and press [OK].**
  - You may be able to use convenient functions depending on the content by pressing [OPTION].
  - Control Panel (⇒ 29) is displayed once the playback starts. Press [OK] if the Control Panel is not displayed, and press [RETURN] to hide the Control Panel.

### To exit from Home Network

Press [EXIT], [HOME] or [POP-UP MENU/TOP MENU].

## Using the Digital Media Controller

You can use the smartphone, etc. as the Digital Media Controller (DMC) to play back contents from DLNA server on the Renderer (this unit).

### Possible applications:

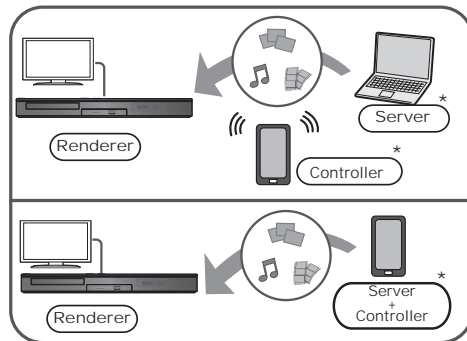

\* DMC compatible software should be installed.

### Preparation

Perform steps ① to ③. (⇒ left)

- ④ Perform the “Remote Device Settings”. (⇒ 34)
  - You can register up to 16 devices.

- 1 Press [HOME].**
- 2 Select “Network”.**
- 3 Select “Home Network”.**
- 4 Select “Media Renderer”.**
- 5 Operate the DMC compatible devices.**

### To exit from Media Renderer screen

Press [HOME].



For more details, refer to the following website and the operating instructions for each of the equipment.  
<http://panasonic.jp/support/global/cs/>  
(This site is in English only.)

- Depending on the contents and the connected equipment, playback may not be possible.
- Items displayed in gray on the display cannot be played back by this unit.
- This unit can be played back via connected equipment only when controlled using DMC.

# Option menu

A variety of playback operations and settings can be performed from this menu.  
Available options differ depending on the playing contents and the condition of the unit.

## About Multi User Mode

: Settings of the items with this indication are saved by the respective users registered in the Home menu.

Please refer to page 19 for details about user registration and switching.

## 1 Press [OPTION].

e.g., BD-Video

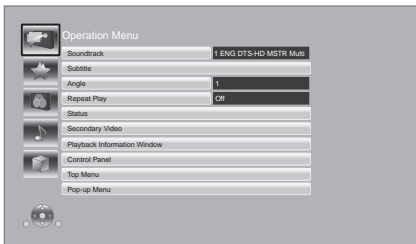

## 2 Select an item and change the settings.

### To exit the screen

Press [OPTION].

Regarding Language: (⇒ 46)

## Operation Menu

### ■ Soundtrack

Show or change the soundtrack.

### ■ Audio channel

Select the audio channel number.

### ■ Subtitle

Change the subtitle settings.

### ■ Angle

Select the number of the angle.

### ■ Repeat Play

(Only when the elapsed time is being displayed on the unit's display.)

Select the item that you want to repeat.

- The items displayed differ depending on the type of media.
- Select "Off" to cancel.

### ■ Shuffle

Select whether or not to play random.

### ■ Start Slideshow

Start the slideshow.

### ■ Status

Show the status messages.

### ■ Rotate Right

### ■ Rotate Left

Rotate the still picture.

### ■ Wallpaper

Set the still picture to the wallpaper of HOME menu. (⇒ 18)

### ■ Icon Personalization

Set the still picture as your user icon. (⇒ 19)

### ■ Video



The recording method of original video appears.

### ■ Secondary Video

<b>Video</b>	Select on/off of images. The recording method of original video appears. <ul style="list-style-type: none"><li>• During search/slow-motion or frame-by-frame, only the primary video is displayed.</li></ul>
<b>Soundtrack</b>	Select on/off of audio and the language.

## ■ Playback Information Window

Displays the following.

	Audio/video attribute information of disc.
	Settings status of "Digital Audio Output" (⇒ 32).
	HDMI output information.

Press [RETURN] to exit.

## ■ Control Panel

Display the Control Panel.

Playing back while using VIERA Link, etc.

e.g.,

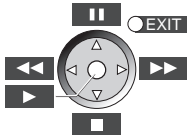

Press [RETURN] to hide the Control Panel.

## ■ Top Menu

Display Top Menu.

## ■ Pop-up Menu

Display Pop-up Menu.

## ■ Menu

Display Menu.

## Personal Preference

You can access settings to enjoy special features of this unit from this category.

Refer to "Video Settings" and "Audio Settings" (⇒ 30) for more details on each setting item.

## Video Settings

### ■ Picture Mode

Select the picture quality mode during play.

- If you select "User", you can change settings in "Picture Adjustment".

### ■ Picture Adjustment

Specific picture quality settings can be performed.

#### ● 3D NR:

Reduces the rough noise in the background to give a greater feeling of depth.

When "24p Output" is set to "On", this function may not operate. (⇒ 32)

#### ● Integrated NR:

Smooths block noise and reduces the smudging that appears around contrasting sections of the picture.

### ■ Chroma Process

The high-resolution processing of HDMI chroma signals produces a high-resolution picture with rich picture quality.

### ■ Detail Clarity

The picture is sharp and detailed.

### ■ Super Resolution

Pictures of normal image quality are corrected to sharp and detailed images when output as 1080i/1080p from HDMI AV OUT.

### ■ Progressive

Select the method of conversion for progressive output to suit the type of material being played.

- When the content is distorted change the settings from "Auto" to "Video".

### ■ 24p

Movies and other material recorded on DVD-Video at 24p are output at 24p.

- Only when you have selected "On" in "24p Output" (⇒ 32).

### ■ Screen Aspect

Switch the screen mode.

### ■ Reset to Default Video Settings

Return video settings to the factory preset.

## Audio Settings

“Surround Effects” and “Sound Effects” can also be set by using the [SURROUND] and [SOUND] on the remote control. (⇒ 37)

### ■ Surround Effects

#### ➤ BD/DVD (Multi-ch Source):

<b>3D Cinema Surround</b>	Expand the sound field forward, backward, upward, right and leftward providing a sound with depth and force that better matches 3D images.
<b>7.1ch Virtual Surround</b>	You can enjoy 6.1/7.1-channel surround-like effect using 5.1-channel speakers.
<b>2ch Stereo</b>	You can play any source in stereo. Sound will be output to the front speakers and the subwoofer only.

#### ➤ TV/CD/iPod (2ch Source):

<b>Multi Channel Out</b>	You can enjoy sound from the front speakers, as well as the surround speakers even when playing stereo sources.
<b>Super Surround</b>	You can enjoy sound from all speakers with stereo sources.
<b>Dolby Pro Logic II Movie</b>	Suitable for movie software, or the one recorded in Dolby Surround.
<b>Dolby Pro Logic II Music</b>	Adds 5.1-channel effects to stereo sources.

### ■ Sound Effects<sup>\*1, 2, 3</sup>

#### ➤ TV/CD/iPod (2ch Source):

Re-master:

This feature gives you brighter sound by increasing the high frequency portion of the audio. (Discs recorded at 48 kHz or less)

Recommended settings:

<b>Re-master 1</b>	Pop and rock
<b>Re-master 2</b>	Jazz
<b>Re-master 3</b>	Classical

Digital Tube Sound:

This feature gives you warm sound, like that produced by a vacuum tube amplifier.

Recommended settings:

<b>Digital Tube Sound 1</b>	A crisp, delicate sound
<b>Digital Tube Sound 2</b>	A tight, hi-fi sound
<b>Digital Tube Sound 3</b>	A soft, rich sound
<b>Digital Tube Sound 4</b>	A clear, powerful sound
<b>Digital Tube Sound 5</b>	A distinctive mid-range sound
<b>Digital Tube Sound 6</b>	A soft, enveloping sound

#### ➤ All:

<b>Equalizer</b>	You can select sound quality settings. <b>Flat/Heavy/Clear/Soft</b>
<b>Subwoofer</b>	You can adjust the amount of bass. <b>Level 1</b> (Weakest effect) to <b>Level 4</b> (Strongest effect) ● Levels can be set by source.
<b>H.Bass</b>	You can enhance low-frequency sound so that heavy bass sound can be heard clearly, even if the acoustics of your room are not optimal.
<b>Whisper-Mode Surround</b>	You can enhance the surround effect for low volume sound. (Convenient for late night viewing.)
<b>Center Focus</b>	You can make the Center channel sound seem like it is coming from within the TV.

### ■ High Clarity Sound Plus

When playing back music contents, it improves the sound quality by stopping the video output.

<sup>\*1</sup> Not every function can be set individually.

<sup>\*2</sup> When audio is output from the HDMI AV OUT terminal this function is effective only when “Dolby D/Dolby D +/Dolby TrueHD” or “DTS/DTS-HD” is set to “PCM”. (⇒ 32)

<sup>\*3</sup> This function has no effect when the type of audio is Dolby Pro Logic II.

## 3D Settings

### ■ Signal Format

<b>Original</b>	Keep original picture format.
<b>Side by side</b>	3D picture format comprising of left and right screens.
<b>2D to 3D</b>	Converts 2D pictures to 3D effect.

### ■ 3D Picture Mode

<b>Normal</b>	Play back pictures with normal 3D effects.
<b>Soft</b>	You can enjoy 3D pictures with a feeling of broadness, holding back the depth perception.
<b>Manual</b>	Play back 3D pictures with settings of "Manual Settings".

### ■ Manual Settings

<b>Distance</b>	Set the amount of depth perception.
<b>Screen Type</b>	Selects how the screen appears during 3D playback (flat or round).
<b>Frame Width</b>	Set the amount of feathering at the edge of screen.
<b>Frame Color</b>	Set the color of feathering at the edge of screen.

### ■ Pop-Out Level

(Only when "Full HD" is selected in "3D Type" (⇒ 33).) 3D position for the Option menu or message screen etc. can be adjusted during 3D playback.

## Setup menu

Change the unit's settings if necessary. The settings remain intact even if you switch the unit to standby.

Some items in the Setup menu are common to the Option menu. You can get the same effect with both menus.

### About Multi User Mode

: Settings of the items with this indication are saved by the respective users registered in the Home menu.

Please refer to page 19 for details about user registration and switching.

- 1 Press [HOME].
- 2 Press [▲, ▼, ◀, ▶] to select "Others" and press [OK].
- 3 Press [◀, ▶] to select "Setup" and press [OK].

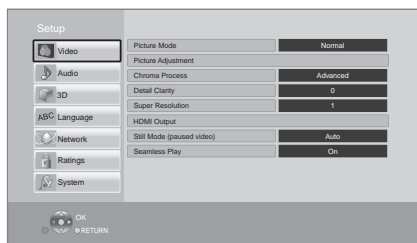

- 4 Select an item and change the settings.

### To exit the screen

Press [HOME].

## Video

### ■ Picture Mode (⇒ 29)

### ■ Picture Adjustment (⇒ 29)

### ■ Chroma Process (⇒ 29)

### ■ Detail Clarity (⇒ 29)

### ■ Super Resolution (⇒ 29)

### ■ HDMI Output

Press [OK] to show the following settings:

### ➤ HDMI Resolution

The items supported by the connected devices are indicated on the screen as “\*”. When any item without “\*” is selected, the images may be distorted.

- If “Auto” is selected, the best suited output resolution to the connected television is automatically selected.
- To enjoy high-definition video up-converted to 1080p, you need to connect the unit directly to 1080p compatible HDTV (High Definition Television). If this unit is connected to an HDTV through other equipment, the other equipment must also be 1080p compatible.

### ➤ 24p Output

When this unit is connected to a TV supporting 1080/24p output using an HDMI cable, movies and other material recorded at 24p are output at 24p.

- When playing DVD-Video, set to “On” and then set “24p” in “Video Settings” (⇒ 29) to “On”.
- When BD-Video images other than 24p are played, images are output at 60p.
- 24p: A progressive image recorded at a rate of 24 frames per second (motion-picture film). Many BD-Video movie contents are recorded in 24 frames/second in accordance with the film materials.

### ➤ HDMI Color Mode

This setting is for selecting color-space conversion of the image signal when the unit is connected using an HDMI cable.

### ➤ Deep Color Output

This setting is for selecting whether to use Deep Color output when a television that supports Deep Color is connected.

### ➤ Contents Type Flag

Depending on the playback content, the TV will output adjusting to the optimal method when a TV that supports this function is connected.

### ■ Still Mode (paused video)

Select the type of picture shown when you pause playback.

<b>Auto</b>	Automatically selects the type of picture shown.
<b>Field</b>	Select if jittering occurs when “Auto” is selected.
<b>Frame</b>	Select if small text or fine patterns cannot be seen clearly when “Auto” is selected.

### ■ Seamless Play

The chapter segments in playlists are played seamlessly.

- Select “On”, when the picture freezes for a moment at the chapters segment in playlists.

## Audio

### ■ Surround Effects (⇒ 30)

### ■ Sound Effects (⇒ 30)

### ■ Dynamic Range Compression

You can listen at low volumes but still hear dialog clearly.

(Dolby Digital, Dolby Digital Plus and Dolby TrueHD only)

- “Auto” is effective only when playing Dolby TrueHD.

### ■ Digital Audio Output

Press [OK] to show the following settings:

#### ➤ Dolby D/Dolby D +/Dolby TrueHD

#### ➤ DTS/DTS-HD

Select the audio signal to output.

- Select “PCM”, when the connected equipment cannot decode the respective audio format. This unit decodes the audio format and transmits to the connected equipment.
- Not making the proper settings may result in noise.

#### ➤ BD-Video Secondary Audio

Select whether or not to mix the primary and secondary audio (including the button click sound). If “Off” is selected, the unit outputs the primary audio only.



### ➤ HDMI Audio Output

This setting selects whether or not to output audio from HDMI.

- Audio will be output through the system's speakers when "Off" is selected.

---

### ■ Digital Audio Input

Press [OK] to show the following settings:

#### ➤ PCM-FIX

Selects the audio output from the devices connected to this unit.

- "On": PCM is available.
- "Off": DTS, PCM and Dolby Digital are available. Select "On" if the sound is cut off intermittently.

---

### ■ TV Audio Input

Select the TV audio input to work with the VIERA Link operations.

---

### ■ Downmix

Select the downmix system of multi-channel to 2-channel sound.

- Select "Surround encoded" to enjoy the surround sound.
- There is no downmix effect on the bitstream audio signal.
- The audio will be output in "Stereo" in the following cases:
  - AVCHD playback
  - Dolby TrueHD playback
  - Playback of secondary audio (including the button click sound).

---

### ■ Audio Delay

Synchronization between picture and sound is corrected by adjusting the delay time of the audio output.

---

### ■ Speaker

Refer to page 36.

## 3D

---

### ■ 3D BD-Video Playback

Select the playback method of 3D compatible video software.

---

### ■ 3D AVCHD Output

Select the output method of 3D AVCHD videos.

---

### ■ 3D Type

Select the format of the connected TV.

- Change the settings for 3D on the TV also when "Checker board" or "Side by side" is selected.

---

### ■ 3D Playback Precautions

Set to display or hide the 3D viewing warning screen when playing back the 3D compatible video software.

---

### ■ Manual Settings (⇒ 31)

---

### ■ Pop-Out Level (⇒ 31)

## Language

---

### ■ Audio Language

Choose the language for audio.

- If "Original" is selected, the original language of each disc will be selected.
- Enter a code (⇒ 46) when you select "Other \*\*\*\*".

---

### ■ Subtitle Language

Choose the language for the subtitle.

- If "Auto" is selected and the language selected for "Audio Language" is not available, subtitles of that language will automatically appear if available on that disc.
- Enter a code (⇒ 46) when you select "Other \*\*\*\*".

## ■ Menu Language

Choose the language for the disc menus.

- Enter a code (⇒ 46) when you select "Other \* \* \* \*".

## ■ Subtitle Text

Select a suitable item according to the language used for MKV subtitles text.

- This item is displayed only after playing back a file.

## ■ On-screen Language

Choose the language for menus and on-screen messages.

# Network

## ■ Easy Network Setting (⇒ 15)

### ■ Network Settings

Perform network-related settings individually. Press [OK] to show the following settings:

#### ➤ LAN Connection Mode

Select the LAN connection method.

#### ➤ Wireless Settings

This allows the wireless router and connection settings to be set. Current connection settings and connection state can be checked.

#### Connection Setting

The wireless router connection wizard will be displayed.

#### Double Speed Mode Setting (2.4GHz)

When a 2.4 GHz wireless format is used, this sets the connection speed.

- If you connect using the "Double Speed Mode (40MHz)", 2 channels use the same frequency band, and there is consequently a greater risk of reception interference. This can cause the connection speed to drop or become unstable.

#### ➤ IP Address/DNS Settings

This is for checking the state of the network connection and setting the IP address and DNS-related.

Press [OK] to show the respective setting.

#### ➤ Proxy Server Settings

This is for checking the state of connection with the Proxy server and performing settings.

Press [OK] to show the respective setting.

## ➤ Network Service Settings (⇒ 26) (VIERA Connect)

Press [OK] to show the following settings:

### Audio Auto Gain Control

Volume that is different depending on the contents is adjusted automatically to the standard volume while using the VIERA Connect.

- Depending on contents, this function effect will not work.
- Select "Off" when the audio is warped.

### Time Zone

By selecting the time zone, it is possible to set the unit's time to match your location.

- Some VIERA Connect contents require the time zone to be set. Set the time zone if necessary.

### DST

Select "On" when using Daylight Saving time.

## ➤ Network Drive Connection

It is possible to access the shared folder of equipment not compatible with DLNA, such as the Windows XP operating system, and play back video, still pictures, and music on this unit. For the setting and operation method of connected equipment, refer to the following Website.

<http://panasonic.jp/support/global/cs/>  
(This site is in English only.)

## ➤ Remote Device Settings (⇒ 27)

Press [OK] to show the following settings:

### Remote Device Operation

Enable to operate by DMC.

- If "On" is selected, "Quick Start" is fixed to "On".

### Setting Unit Name

Set the name of this unit to be displayed on the connected equipment.

- **BTT196** **BTT195** : With the default setting, the unit name will be displayed as "SC-BTT195".

## Registration Type

<b>Auto</b>	Allow connection to all the equipment that is accessing this unit.
<b>Manual</b>	Set the permission of the connection individually for the equipment that is accessing this unit.

## Remote Device List

Registering/deregistering of the displayed equipment can be performed when "Manual" in "Registration Type" is selected.

## ➤ BD-Live Internet Access (⇒ 21)

You can restrict Internet access when BD-Live functions are used.

- If "Allow (Limited)" is selected, Internet access is permitted only for BD-Live contents which have content owner certificates.

## Ratings

The following items use the same password. Don't forget your password.

### ■ DVD-Video Ratings

Set a ratings level to limit DVD-Video play.

### ■ BD-Video Ratings

Set an age limit of BD-Video play.

### ■ Network Service Lock

You can restrict the usage of VIERA Connect.

## System

### ■ Easy Setting

You can execute basic settings.



### ■ Display Settings

Press [OK] to show the following settings:

## ➤ TV Aspect

Set to match the type of television connected.

When connected to a 4:3 aspect television and playing 16:9 ratio image:

<b>4:3</b>	The sides are cut off so the picture fills the screen. When playing BD-Video, video is output as "4:3 Letterbox". 
<b>4:3 Letterbox</b>	Black bands appear at the top and bottom of the picture. 

When connected to a 16:9 widescreen television and playing 4:3 ratio image:

<b>16:9</b>	Video is displayed as a 4:3 ratio image in the center of the screen.
-------------	--

## ➤ Screen Saver Function

This is to prevent burn-in on the screen.

- When this is set to "On":  
If a list of playback content is displayed and there is no operation for 10 minutes or more, the screen switches to HOME menu automatically.
- While playing and pausing, etc., this function is not available.

## ➤ Status Messages

Choose whether to show status messages automatically.

## ➤ VIERA Link

Set to use "HDAVI Control" function when connected via HDMI cable to a device that supports "HDAVI Control".

- Select "Off" when you do not want to use "HDAVI Control".

## Power Off link

Select the desired power off link setting of this unit for VIERA Link operation (⇒ 23). (This works depending on the settings of the connected VIERA Link "HDAVI Control" compatible equipment.)

### Video/Audio:

When the TV is turned off, this unit will turn off automatically.

### Video:

When playing back audio only content, the unit will not turn off automatically.

## ■ Unit Settings

Press [OK] to show the following settings:

### ➤ Front Panel Display

Changes the brightness of the unit's display.

- If "Auto" is selected, the display is set to bright and only dimmed during playback.

### ➤ Edit User Information

Change the user information registered in the Home menu.

## ■ Quick Start

Speed of startup from power off is increased.

- When set to "On", the internal control unit will be powered and the idle power consumption will increase compared to when set to "Off". (About the power consumption ⇒ 45)

## ■ Remote Control Code

Change the remote control code if other Panasonic products react to this remote control.

## ■ Firmware Update (⇒ 16)

Press [OK] to show the following settings:

### ➤ Automatic Update Check

When this equipment remains connected to the Internet, it will check for the latest firmware version when it is turned on and you can update it if necessary.

### ➤ Update Now

You can update the firmware manually if a firmware update is available.

## ■ System Information

Press [OK] to show the following settings:

### ➤ License

Information about the software used by this unit is displayed.

### ➤ Firmware Version Information

Display firmware version of this unit and wireless LAN module.

## ■ Restore Default Settings

This returns all values in the Setup menu and the Option menu to the default settings, except for some settings of network, ratings, remote control code, language, etc.

## Speaker settings

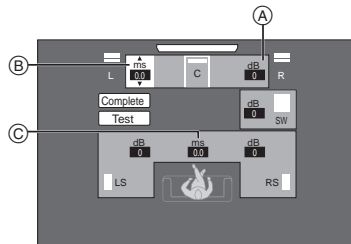

- (A) Volume (Channel balance)
- (B) Delay time for the Center speaker
- (C) Delay time for the Surround speakers

## ■ Adjusting speaker level

(Effective when playing multi-channel audio)

### 1 Select "Test" and press [OK].

A test signal is output.

### 2 While listening to the test signal

Press [**▲**, **▼**] to adjust the volume of each speaker (dB).

The volume can be adjusted between +6 dB to -6 dB.

- Set each speaker level according to the volume of the Front (L) and Front (R) speaker volume respectively.

### 3 Press [OK].

The test signal stops.

## ■ Delay time

For optimum listening with 5.1-channel sound, all the speakers, except for the subwoofer, should be the same distance from the seating position. If either distance ① or ② is less than ③, measure the distance and adjust the time to make up for the difference (see the table below).

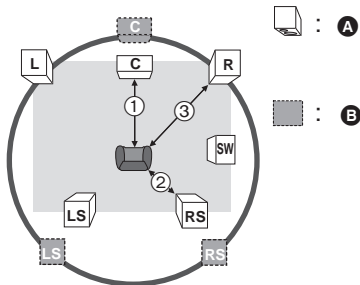

- ① ② ③: Primary listening distance  
**A** Actual speaker position  
**B** Ideal speaker position

- Press [**▲**, **▼**, **◀**, **▶**] to select the distance box (ms) and press [OK].
- Press [**▲**, **▼**] to select the setting and press [OK].

### Delay time for the Center speaker

Subtract the distance ① from ③

Distance (Approx.)	Setting
34 cm (1 ft. 1 in.)	1.0 ms
68 cm (2 ft. 2 in.)	2.0 ms
102 cm (3 ft. 4 in.)	3.0 ms
136 cm (4 ft. 5 in.)	4.0 ms
170 cm (5 ft. 6 in.)	5.0 ms

### Delay time for the Surround speakers

Subtract the distance ② from ③

Distance (Approx.)	Setting
170 cm (5 ft. 6 in.)	5.0 ms
340 cm (11 ft. 1 in.)	10.0 ms
510 cm (16 ft. 8 in.)	15.0 ms

### To finish the speaker setting

Press [**▲**, **▼**, **◀**, **▶**] to select "Complete" and press [OK].

# Enjoying sound effects from all speakers

For more details on each setting, refer to "Audio Settings" on the Option menu (⇒ 30)

## Surround Effects

- Press [SURROUND].
- Press [**▲**, **▼**] to select "MULTI CH SOURCE" or "2CH SOURCE", and then press [OK].  
e.g.,



- While the selected mode is displayed Press [**▲**, **▼**] to select the desired setting. (⇒ 30)

## ■ Adjusting speaker level during play

- Press [CH SELECT] to activate the speaker setting mode.
- Press [CH SELECT] several times to select the speaker.  
• Press [**◀**, **▶**] to adjust the balance of the front speakers.
- Press [**▲**] (increase) or [**▼**] (decrease) to adjust the speaker level for each speaker.  
-6 dB to +6 dB

## Sound Effects

- Press [SOUND].
- Press [**▲**, **▼**] to select "2CH SOURCE" or "ALL SOURCE", and then press [OK].  
e.g.,



- While the selected mode is displayed Press [**▲**, **▼**] to select the desired setting and press [OK].  
Repeat this procedure if necessary. (⇒ 30)



- The sound effects/modes may not be available or have no effect with some sources.
- You may experience a reduction in sound quality when these sound effects/modes are used with some sources. If this occurs, turn the sound effects/modes off.

# Speaker installation option

Consult a qualified building contractor when attaching the speakers to a wall. Improper attachment may result in damage to the wall and speakers and personal injury.

## Attaching to a wall

You can attach all of the speakers (except subwoofer) to a wall.

- The wall or pillar on which the speakers are to be attached should be capable of supporting 10 kg (22 lbs) per screw.

### 1 Drive a screw (not supplied) into the wall.

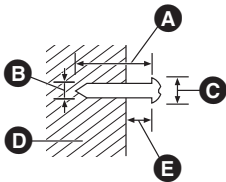

- A** At least 30 mm ( $1 \frac{3}{16}$ " )
- B**  $\varnothing$  4.0 mm ( $\frac{5}{32}$ " )
- C**  $\varnothing$  7.0 mm to  $\varnothing$  9.4 mm ( $\frac{9}{32}$ " to  $\frac{3}{8}$ " )
- D** Wall or pillar
- E** 5.5 mm to 7.5 mm ( $\frac{7}{32}$ " to  $\frac{5}{16}$ " )

### 2 Fit the speaker securely onto the screw(s) with the hole(s).

e.g., <b>BTT196</b> Front speaker	
DO NOT	DO
<ul style="list-style-type: none"> <li>In this position, the speaker will likely fall if moved to the left or right.</li> </ul>	<ul style="list-style-type: none"> <li>Move the speaker so that the screw is in this position.</li> </ul>

Use the measurements indicated below to identify the screwing positions on the wall.

- Leave at least 20 mm ( $\frac{25}{32}$ " ) of space above the speaker and 10 mm ( $\frac{13}{32}$ " ) on each side to allow enough space for fitting the speaker.

## **BTT196** **BTT195**

### Front speaker

Attach to a wall without the base and the stand.

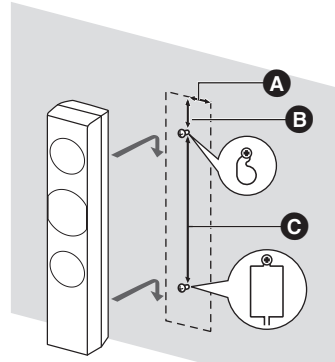

- A** 51 mm (2")
- B** 64 mm ( $2 \frac{17}{30}$ " )
- C** 350 mm ( $13 \frac{25}{32}$ " )

## **BTT190**

### Front speaker, Surround speaker

## **BTT196** **BTT195**

### Surround speaker

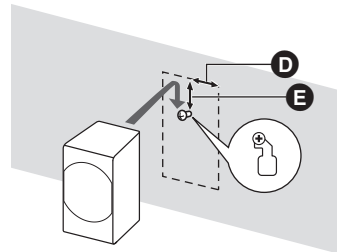

- D** 40 mm ( $1 \frac{9}{16}$ " )
- E** 24 mm ( $\frac{15}{16}$ " )

### Center speaker

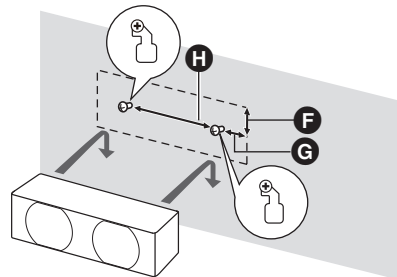

- F** 18 mm ( $\frac{23}{32}$ " )
- G** 25 mm ( $\frac{31}{32}$ " )
- H** 230.5 mm ( $9 \frac{1}{16}$ " )

## Front speaker assembly option

It is possible to shorten the height of the front speaker by directly connecting the speaker to the base without using the stand.

### Preparation

Detach the speaker cable from the stand.

- 1 Thread the detached cable through the base.

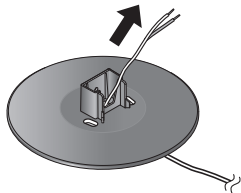

- 2 Attach the speaker to the base and tighten the screw (supplied) securely.

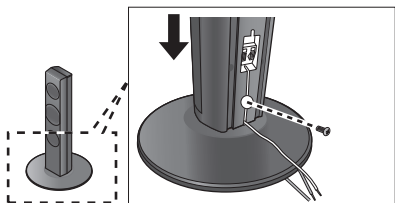

- 3 Connect the speaker cable to the speaker and to the terminal of the main unit. (⇒ 11, 12)

### Reattaching the speaker cable to the stand



Straighten the cable and run through the stand.



Pull out the cable through the hole.

## Preventing the speakers from falling or dropping

### BTT196 BTT195 Preventing from falling

Front speaker

### Preventing from dropping

Front speaker, Surround speaker, Center speaker

- 1 Thread a string to the speaker.

- Use a string of less than  $\varnothing$  2.0 mm ( $3/32''$ ), which is capable of supporting over 10 kg (22 lbs).

e.g., BTT196 Front speaker

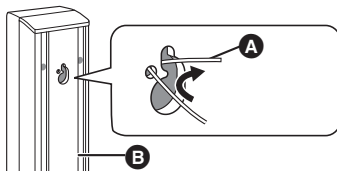

- A String (not supplied)
- B Rear of the speaker

- 2 Thread a string from the wall to the speaker and tie tightly.

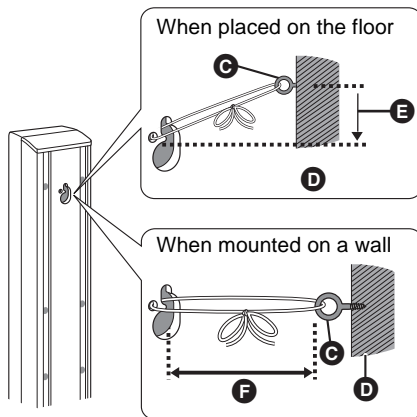

- C Screw eye (not supplied)
- D Wall
- E Approx. 150 mm ( $5\ 29/32''$ )
- F Less than 100 mm ( $3\ 15/16''$ )

# Troubleshooting guide

Before requesting service, please perform the following steps.

## Do you have the latest firmware installed?

Firmware updates may be released to correct operating irregularities that are discovered with certain movies. (⇒ 16)



**Make the following checks and visit our website for more information.**

**For U.S.A.:**

[www.panasonic.com/help](http://www.panasonic.com/help)

Enter the model number.

**For Canada:**

<http://www.panasonic.ca>



**Or visit our website to find a service center.**

You can find a service center near you easily on our website.

## Other support information:

“Customer Services Directory (United States and Puerto Rico)” (⇒ 50) or “Limited Warranty (Only for CANADA)” (⇒ 51).

The following do not indicate a problem with this unit:

- Regular disc rotating sounds.
- Image disturbance during search.
- Image disturbance when replacing 3D discs.

## ■ Unit doesn't respond to remote control or front panel buttons.

Press and hold [⏻/|] on the main unit for 3 seconds.

- If still unable to power the unit off, disconnect the power cord, wait 1 minute, then reconnect the power cord.

## ■ Cannot eject disc.

The unit may have a problem.

- ① While the unit is off, press and hold [OK], [B] and [Y] on the remote control at the same time for more than 5 seconds.  
–“00 RET” is displayed on the unit's display.
- ② Repeatedly press [▶] (right) on the remote control or [⏻/|] on the unit until “06 FTO” is displayed on the unit's display.
- ③ Press [OK] on the remote control or [▲ OPEN/CLOSE] on the unit.

## General operation

**To return to the factory preset.**

- Select “Yes” in “Restore Default Settings” in the Setup menu. (⇒ 36)

**To return all settings to the factory preset.**

- Reset the unit as follows:
  - ① While the unit is off, press and hold [OK], [B] and [Y] on the remote control at the same time for more than 5 seconds.  
–“00 RET” is displayed on the unit's display.
  - ② Repeatedly press [▶] (right) on the remote control or [⏻/|] on the unit until “08 FIN” is displayed on the unit's display.
  - ③ Press and hold [OK] on the remote control or [▲ OPEN/CLOSE] on the unit for at least 3 seconds.

**This unit is turned off when the input for the TV is switched.**

- This is a normal phenomenon when using VIERA Link (HDAVI Control 4 or later). For details please read the operating instructions for the TV.

**The remote control doesn't work properly.**

- Change the batteries in the remote control. (⇒ 8)
- The remote control and main unit are using different codes. If “SET □” is displayed on the unit's display when a button is pressed on the remote control, change the code on the remote control. (⇒ 36, 44)

**The TV tuner mode is not displayed when the TV is switched on.**

- This phenomenon may occur, depending on the TV setting, when “Quick Start” is set to “On”.
- Depending on the TV, this phenomenon may be prevented by reconnecting the HDMI cable to a different HDMI input terminal or by changing the HDMI auto connection setting.

**You have forgotten your ratings password. You want to cancel the ratings level.**

- The ratings level returns to the factory preset.
  - ① While the unit is on, press and hold [OK], [B] and [Y] on the remote control at the same time for more than 5 seconds.  
–“00 RET” is displayed on the unit's display.
  - ② Repeatedly press [▶] (right) on the remote control or [⏻/|] on the unit until “03 VL” is displayed on the unit's display.
  - ③ Press [OK] on the remote control or [▲ OPEN/CLOSE] on the unit.

**This unit does not recognize the USB connection correctly.**

- Disconnect and reconnect the USB cable. If it still does not recognize the connection, turn the power of this unit off and on again.
- USB devices may not be recognized by this unit when connected using the following :



- a USB hub
- a USB extension cable other than the supplied with the Wireless LAN Adaptor DY-WL5 (optional)
- If you connect USB HDD to this unit, use the USB cable that is supplied with the HDD.

### The unit switches to standby mode.

- This unit will automatically turn to standby mode after 30 minutes if it is inactive. (⇒ 18)
- When the time set for the sleep timer has passed, the power will be turned off. (⇒ 8)
- One of the unit's safety devices is activated. Press [⏻/⏪] on the main unit to turn the unit on.

### The unit does not turn off.

- ① Press and hold [⏻/⏪] on the main unit for 5 seconds. (If still unable to power the unit off, disconnect the power cord, wait 1 minute, then reconnect the power cord.)
- ② Reset the unit as follows:  
While the unit is off, press and hold [+ VOLUME], [▲ OPEN/CLOSE] and [⏻/⏪] on the main unit at the same time for more than 5 seconds.

## Picture

### The images from this unit do not appear on the TV. Picture is distorted. Jittering occurs.

- An incorrect resolution is selected in "HDMI Resolution". Reset the setting as follows:
  - ① While the unit is on, press and hold [OK], [B] and [Y] on the remote control at the same time for more than 5 seconds.  
–"00 RET" is displayed on the unit's display.
  - ② Repeatedly press [▶] (right) on the remote control or [⏻/⏪] on the unit until "04 PRG" is displayed on the unit's display.
  - ③ Press and hold [OK] on the remote control or [▲ OPEN/CLOSE] on the unit for at least 3 seconds.  
Set the item again. (⇒ 32)  
–When Dolby Digital Plus, Dolby TrueHD, and DTS-HD audio are not output in bitstream, select "Yes" in "Restore Default Settings" and make proper settings. (⇒ 36)
- When "3D BD-Video Playback" in the Setup menu is set to "Auto", images may not be output depending on the connection method. After removing the disc from this unit, select "Set before play" in the Setup menu, and select "2D Playback" in the setup screen displayed when playing 3D discs. (⇒ 33)

- If irregular coloring occurs on your TV, turn the TV off for about 30 minutes.  
If it persists, move the speakers further away from the TV.

### Video is not output in high-definition.

- Confirm that "HDMI Resolution" in the Setup menu is set properly. (⇒ 32)

### 3D video is not output.

- Change the settings as required by the connected TV format. (⇒ 33, "3D Type")
- Are the settings on this unit and the TV correct? (⇒ 21)
- Depending on the connected TV, the video being played back might switch to 2D video due to changes in resolution etc. Check the 3D setting on the TV.
- Check that proper HDMI video input is selected on the TV.

### 3D video is not output correctly as 2D.

- Select "Set before play" in the Setup menu, and select "2D Playback" in the setup screen displayed when playing 3D discs. (⇒ 33, "3D BD-Video Playback")
- Discs that have recorded titles with Side by side (2 screen structure) and that can be enjoyed in 3D are played back in accordance with the settings of the TV.

### No subtitles.

- When progressive output is on, closed captions/subtitles cannot be displayed.

### The subtitles overlap closed captions recorded on discs.

- Turn off the subtitles or the closed caption setting on the TV. (⇒ 28)

### A black band is displayed around the edge of the screen.

#### The aspect ratio of the screen is abnormal.

- Confirm the "TV Aspect" is set properly. (⇒ 35)
- Adjust the aspect setting on the television.

## Sound

### No sound.

#### Low volume.

#### Distorted sound.

##### Cannot hear the desired audio type.

- Check connections to speakers and other equipment. (⇒ 11–14)
- Ensure the speaker settings for your speakers are correct. (⇒ 36)
- To output audio from a device connected with an HDMI cable, set “HDMI Audio Output” to “On” in the Setup menu. (⇒ 33)
- When “BD-Video Secondary Audio” is set to “On”, Dolby TrueHD, Dolby Digital Plus, DTS-HD Master Audio and DTS-HD High Resolution Audio are output as Dolby Digital or DTS Digital Surround.
- Re-master will not work when the bitstream signal is output from the HDMI AV OUT terminal. (⇒ 30)
- Depending on the connected equipment, the sound may be distorted if this unit is connected with an HDMI cable.
- The multi-channel audio from a device connected to the TV is not output in its original multi-channel form.
  - If the device has an optical audio output terminal, connect the device to this unit’s DIGITAL AUDIO IN terminal. (⇒ 13)

### No surround sound.

- Press [SURROUND] to select a surround effect. (⇒ 37)

### Cannot switch audio.

- When audio is output from the HDMI AV OUT terminal, set “Dolby D/Dolby D +/Dolby TrueHD” or “DTS/DTS-HD” to “PCM”. (⇒ 32)

### No sound from the TV.

- Press [EXT-IN] to select the corresponding source. (⇒ 17)
- When connecting the unit to a TV using an HDMI cable, check whether the HDMI terminal on the TV is labeled “HDMI (ARC)”. If not labeled in this way, connect using the HDMI cable in combination with an optical digital audio cable. (⇒ 12)
- If there is no sound from the equipment connected to this unit’s DIGITAL AUDIO IN terminal, please make sure that the optical audio output of the equipment is set to PCM.

## Playback

### Disc cannot be played.

- The disc is dirty. (⇒ 5)

### Still pictures (JPEG) do not play back normally.

- The images that were edited on the PC, such as Progressive JPEG, etc., may not be played back.

### I can’t play back BD-Live.

- The SD card is write-protected. (⇒ 7)
- Confirm that this unit is connected to the broadband Internet. (⇒ 14)
- Confirm the “BD-Live Internet Access” settings. (⇒ 35)
- Confirm an SD card is inserted into the SD card slot. (⇒ 17)

### Alternative soundtrack and subtitles cannot be selected.

- The languages are not recorded on the disc.
- You may not be able to use the Option menu to change the soundtrack and subtitles on some discs. Use the disc’s menus to make changes. (⇒ 20)

## iPod/iPhone operation

### Cannot charge or operate.

- Check that the iPod/iPhone is connected firmly. (⇒ 22)
- The battery of the iPod/iPhone is depleted. Charge the iPod/iPhone, and then operate again.
- When unexpected operation occurs while using the iPod/iPhone, connect the iPod/iPhone again or try to restart the iPod/iPhone.

## Radio

### Distorted sound or noise is heard.

- Adjust the position of the antenna.

### A beat sound is heard.

- Try to keep a certain amount of distance between the antenna and the TV.

### Stations cannot be selected.

- ① Press [RADIO] to select “FM”.
- ② Press and hold [RADIO].

After a few seconds the display changes to show the current lowest frequency (87.9 MHz). Continue to hold the button down. The lowest frequency changes (87.5 MHz) and the step is changed.

### Noise is excessive.

- Change the audio to be output as monaural.
- ① Press and hold [–AUDIO].
- ② Press [–AUDIO] to select "MONO".
  - The sound becomes monaural.
  - To cancel, press the button again or change the frequency.

In normal circumstances, select "AUTO STEREO"

## Network

### I can't connect to the network.

- Confirm the network connection and settings. (⇒ 14, 15, 34)
- Check the operating instructions for each device and connect accordingly.

### When using wireless LAN connection, video from the DLNA Certified media server is not played back or video frames are dropped during playback.

- Higher transfer rate router such as 802.11n (2.4 GHz) wireless router may solve the problem. If you use 802.11n (2.4 GHz) wireless router, it is necessary to set the encryption type to "AES".

Simultaneous use with a microwave, cordless telephone etc. at 2.4 GHz may result in connection interruptions or other problems.
- On the "Wireless Settings" screen (⇒ 34), the continuous lighting of at least 4 "Reception" indicators is the target for a stable connection. If 3 or fewer indicators are lit or the connection is being interrupted, change the position or angle of your wireless router and see if the connection state improves. If there is no improvement, connect to a wired network and perform the "Easy Network Setting" (⇒ 15) again.

## Messages

The following messages or service numbers appear on the television or unit's display.

### On the television

#### Cannot play.

- You inserted an incompatible disc (Discs recorded in PAL video, etc.).

#### Cannot display on this unit.

- You tried to play a non-compatible image.
- Confirm "SD" on the unit's display is not displayed and re-insert the card.

#### No disc inserted.

- The disc may be upside down.

#### ⊘ This operation is not available.

- Some operations are unsupported by the unit. For example;
  - BD-Video: During playback, reverse slow-motion or reverse frame-by-frame is not possible.

#### IP address is not set.

- The "IP Address" in "IP Address/DNS Settings" is "---. ---. ---. ---". Set the "IP Address", "Subnet Mask", and "Default Gateway". (Select the automatic address acquisition if necessary.)

#### The current wireless network security setting is weak. It is recommended to change to a stronger security setting.

- Authentication type for the wireless LAN is set to "Open system", or the encryption type is set to "No encryption". It is recommended to encrypt for safety reasons. For details, refer to the instructions of the wireless router being used. Encryption is required when playing back video, etc., from DLNA compatible devices.

### On the unit's display

#### F99

- The unit fails to operate properly. Press [⏻/⏪] on the main unit for 3 seconds to switch the unit to standby, then switch back on.

## NET

- While connecting to a network.
- 

## No PLAY

- There is a viewing restriction on a BD-Video or DVD-Video. (⇒ 35)
- 

## No READ

- The media is dirty or badly scratched. The unit cannot play.
- 

## PLEASE WAIT

- The unit is carrying out an internal process. This is not a malfunction. You cannot operate the unit while "PLEASE WAIT" is displayed.
- 

## REMOVE

- The USB device is drawing too much power. Remove the USB device.
- 

## SET □ ("□" stands for a number.)

- The remote control and main unit are using different codes. Change the code on the remote control.

Press and hold [OK] and the indicated number button at the same time for more than 5 seconds.



## U59

- The unit is hot. The unit switches to standby for safety reasons. Wait for about 30 minutes until the message disappears. Select a position with good ventilation when installing the unit.
- 

## H□□ or F□□

### ("□" stands for a number.)

- Check and correct the speaker cable connections.
- There is something unusual.
- Check the unit using the troubleshooting guide. If the service number remains displayed, do the following.
  - ① Disconnect the plug from the AC outlet, wait a few seconds, then reconnect it.
  - ② Press [⏻/|] to turn the power on.

If the service number remains displayed despite doing the above, request service from the dealer. Inform the dealer of the service number when requesting service.

---

## IPOD OVER CURRENT ERROR

- The iPod/iPhone is drawing too much power. Remove the iPod/iPhone, and turn the unit off and on again.
- 

## START

- The system is being restarted during the firmware update. Please do not turn off the unit.
- 

## UPD□/□

### ("□" stands for a number.)

- The firmware is being updated. Please do not turn off the unit.
- 

## FINISH

- The firmware update is complete.
- 

## NOT CONDITIONAL

- The requested operation cannot be conducted.
- 

## SET OK

- The stations are set, and the radio tunes to the last preset station.
- 

## ERROR

- Automatic presetting is unsuccessful. Preset the stations manually.
- 

## TUNED/STEREO

- Stereo broadcasting or stereo sound is selected.
- 

## TUNED

- Monaural broadcasting or monaural sound is selected.
-

# Specifications

## GENERAL

<b>Power consumption:</b>	83 W
<b>Power consumption in standby mode:</b>	Approx. 0.05 W
<b>Power supply:</b>	AC 120 V, 60 Hz

<b>Dimensions (W×H×D):</b>	430 mm×47 mm×263 mm (16 <sup>15</sup> / <sub>16</sub> "×1 <sup>55</sup> / <sub>64</sub> "×10 <sup>23</sup> / <sub>64</sub> " )
<b>Mass (Weight):</b>	Approx. 2.4 kg (5.3 lbs)
<b>Operating temperature range:</b>	0 °C to 40 °C (32 °F to 104 °F)
<b>Operating humidity range:</b>	35 % to 80 % RH (no condensation)

## AMPLIFIER SECTION

<b>RMS TOTAL POWER OUTPUT:</b>	1000 W
<b>1 kHz, 10 % total harmonic distortion</b>	
<b>FRONT:</b>	160 W per ch (3 Ω)
<b>CENTER:</b>	160 W per ch (3 Ω)
<b>SURROUND:</b>	160 W per ch (3 Ω)
<b>100 Hz, 10 % total harmonic distortion</b>	
<b>SUBWOOFER:</b>	200 W per ch (3 Ω)
<b>FTC TOTAL POWER OUTPUT:</b>	430 W
<b>120 Hz to 20 kHz, 1.0 % total harmonic distortion</b>	
<b>FRONT:</b>	60 W per ch (3 Ω)
<b>CENTER:</b>	90 W per ch (3 Ω)
<b>SURROUND:</b>	60 W per ch (3 Ω)
<b>45 Hz to 120 Hz, 1.0 % total harmonic distortion</b>	
<b>SUBWOOFER:</b>	100 W (3 Ω)

### Audio Input

AUX: × 1

### Digital Audio Input

Optical × 1

Sampling frequency: 32 kHz, 44.1 kHz, 48 kHz

Audio Format: PCM, Dolby Digital, DTS

## FM TUNER SECTION

<b>Frequency range:</b>	87.9 MHz to 107.9 MHz (200 kHz step), 87.5 MHz to 108.0 MHz (100 kHz step)
<b>Antenna terminals:</b>	75 Ω (unbalanced)

## SPEAKER SECTION\*

### FRONT SPEAKERS

#### **BTT196 BTT195**

<b>Full range:</b>	6.5 cm (2 <sup>1</sup> / <sub>2</sub> " ) CONE TYPE
<b>Dimensions (W×H×D):</b>	292 mm×1185 mm×292 mm (11 <sup>1</sup> / <sub>2</sub> "×46 <sup>21</sup> / <sub>32</sub> "×11 <sup>1</sup> / <sub>2</sub> " )
<b>Mass (Weight):</b>	Approx. 2.42 kg (5.3 lbs)

#### **BTT190**

<b>Full range:</b>	6.5 cm (2 <sup>1</sup> / <sub>2</sub> " ) CONE TYPE
<b>Dimensions (W×H×D):</b>	80 mm×139 mm×71 mm (3 <sup>5</sup> / <sub>32</sub> "×5 <sup>1</sup> / <sub>2</sub> "×2 <sup>13</sup> / <sub>16</sub> " )
<b>Mass (Weight):</b>	Approx. 0.37 kg (0.8 lbs)
<b>CENTER SPEAKER</b>	
<b>Full range:</b>	6.5 cm (2 <sup>1</sup> / <sub>2</sub> " ) CONE TYPE
<b>Super Tweeter:</b>	Piezo type
<b>Dimensions (W×H×D):</b>	280 mm×84 mm×78 mm (11 <sup>1</sup> / <sub>32</sub> "×3 <sup>5</sup> / <sub>16</sub> "×3 <sup>3</sup> / <sub>32</sub> " )
<b>Mass (Weight):</b>	Approx. 0.53 kg (1.2 lbs)
<b>SURROUND SPEAKERS</b>	
<b>Full range:</b>	6.5 cm (2 <sup>1</sup> / <sub>2</sub> " ) CONE TYPE
<b>Dimensions (W×H×D):</b>	80 mm×139 mm×71 mm (3 <sup>5</sup> / <sub>32</sub> "×5 <sup>1</sup> / <sub>2</sub> "×2 <sup>13</sup> / <sub>16</sub> " )
<b>Mass (Weight):</b>	Approx. 0.37 kg (0.8 lbs)
<b>SUBWOOFER</b>	
<b>Woofers:</b>	16 cm (6 <sup>1</sup> / <sub>2</sub> " ) CONE TYPE
<b>Dimensions (W×H×D):</b>	145 mm×289.5 mm×258 mm (5 <sup>23</sup> / <sub>32</sub> "×11 <sup>13</sup> / <sub>32</sub> "×10 <sup>5</sup> / <sub>32</sub> " )
<b>Mass (Weight):</b>	Approx. 3.0 kg (6.6 lbs)

\* The impedance of all the speakers is 3 Ω.

## TERMINAL SECTION

<b>USB slot:</b>	USB2.0: 2 system
<b>SD card slot:</b>	Connector: 1 system
<b>Ethernet:</b>	10BASE-T/100BASE-TX 1 system

## VIDEO SECTION

<b>Signal system:</b>	NTSC
<b>HDMI AV output*</b>	
<b>Output connector:</b>	Type A (19 pin)

### LASER Specification

#### **Class I LASER Product**

<b>Wave length:</b>	790 nm (CDs)/660 nm (DVDs)/405 nm (BDs)
<b>Laser power:</b>	No hazardous radiation is emitted with the safety protection

\* This unit supports "HDAVI Control 5" function.

Specifications are subject to change without notice.

## File format

File format	Extension	Reference
MP3	“.MP3”, “.mp3”	This unit supports ID3 tags, but only titles, artist names and album names can be displayed.
JPEG	“.JPG”, “.jpg”	<ul style="list-style-type: none"> <li>MOTION JPEG and Progressive JPEG is not supported</li> <li>You may not be able to play back the file if you have edited the folder structure or the file name on a PC or other device.</li> </ul>
MKV	“.MKV”, “.mkv”	<ul style="list-style-type: none"> <li>The video file and subtitles text file are inside the same folder, and the file names are the same except for the file extensions.</li> <li>Some MKV files may not play back, depending on the video resolution and frame rate condition.</li> </ul>
	Subtitles text file “.SRT”, “.srt”, “.SSA”, “.ssa”, “.ASS”, “.ass”	
FLAC	“.flac”	Maximum sampling rate: 192 kHz/24 bit
WAV	“.wav”	Maximum sampling rate: 48 kHz/16 bit
MPO	“.mpo”	3D still picture

- With certain recording states and folder structures, the play order may differ or playback may not be possible.

## Restriction on use of unauthorized copied content

This unit adopts the following technology for copyright protection.

### Cinavia Notice

This product uses Cinavia technology to limit the use of unauthorized copies of some commercially-produced film and videos and their soundtracks. When a prohibited use of an unauthorized copy is detected, a message will be displayed and playback or copying will be interrupted.

More information about Cinavia technology is provided at the Cinavia Online Consumer Information Center at <http://www.cinavia.com>. To request additional information about Cinavia by mail, send a postcard with your mailing address to:

Cinavia Consumer Information Center, P.O. Box 86851, San Diego, CA, 92138, USA.

# Supplemental information

## ■ Display languages list

Display	Language	Display	Language	Display	Language
ENG	English	JPN	Japanese	ARA	Arabic
FRA	French	CHI	Chinese	HIN	Hindi
DEU	German	KOR	Korean	PER	Persian
ITA	Italian	MAL	Malay	IND	Indonesian
ESP	Spanish	VIE	Vietnamese	MRI	Maori
NLD	Dutch	THA	Thai	BUL	Bulgarian
SVE	Swedish	POL	Polish	RUM	Romanian
NOR	Norwegian	CES	Czech	GRE	Greek
DAN	Danish	SLK	Slovak	TUR	Turkish
POR	Portuguese	HUN	Hungarian	*	Others
RUS	Russian	FIN	Finnish		

## ■ Language code list

Language	Code	Language	Code	Language	Code
Abkhazian:	6566	Gujarati:	7185	Rhaeto-Romance:	
Afar:	6565	Hausa:	7265	Romanian:	8279
Afrikaans:	6570	Hebrew:	7387	Russian:	8285
Albanian:	8381	Hindi:	7273	Samoan:	8377
Amharic:	6577	Hungarian:	7285	Sanskrit:	8365
Arabic:	6582	Icelandic:	7383	Scots Gaelic:	7168
Armenian:	7289	Indonesian:	7378	Shona:	8378
Assamese:	6583	Interlingua:	7365	Serbian:	8382
Aymara:	6589	Irish:	7165	Serbo-Croatian:	8372
Azerbaijani:	6590	Italian:	7384	Sinhala:	8375
Bashkir:	6665	Japanese:	7465	Sindhi:	8368
Basque:	6985	Javanese:	7487	Singhalese:	8373
Bengali, Bangla:		Kannada:	7578	Slovak:	8376
	6678	Kashmiri:	7583	Slovenian:	8376
Bhutani:	6890	Kazakh:	7575	Somali:	8379
Bihari:	6672	Kirghiz:	7589	Spanish:	6983
Breton:	6682	Korean:	7579	Sundanese:	8385
Bulgarian:	6671	Kurdish:	7585	Swahili:	8387
Burmese:	7789	Laotian:	7679	Swedish:	8386
Byelorussian:	6669	Latin:	7665	Tagalog:	8476
Cambodian:	7577	Latvian, Lettish:	7686	Tajik:	8471
Catalan:	6765	Lingala:	7678	Tamil:	8465
Chinese:	9072	Lithuanian:	7684	Tatar:	8484
Corsican:	6779	Macedonian:	7775	Telugu:	8469
Croatian:	7282	Malagasy:	7771	Thai:	8472
Czech:	6783	Malay:	7783	Tibetan:	6679
Danish:	6865	Malayalam:	7776	Tigrinya:	8473
Dutch:	7876	Maltese:	7784	Tonga:	8479
English:	6978	Maori:	7773	Turkish:	8482
Esperanto:	6979	Marathi:	7782	Turkmen:	8475
Estonian:	6984	Moldavian:	7779	Twi:	8487
Faroese:	7079	Mongolian:	7778	Ukrainian:	8575
Fiji:	7074	Nauru:	7865	Urdu:	8582
Finnish:	7073	Nepali:	7869	Uzbek:	8590
French:	7082	Norwegian:	7879	Vietnamese:	8673
Frisian:	7089	Oriya:	7982	Volapük:	8679
Galician:	7176	Pashto, Pushto:	8083	Welsh:	6789
Georgian:	7565	Persian:	7065	Wolof:	8779
German:	6869	Polish:	8076	Xhosa:	8872
Greek:	6976	Portuguese:	8084	Yiddish:	7473
Greenlandic:	7576	Punjabi:	8065	Yoruba:	8979
Guarani:	7178	Quechua:	8185	Zulu:	9085

**THE FOLLOWING APPLIES ONLY IN THE U.S.A.**

**FCC Note:**

This equipment has been tested and found to comply with the limits for a Class B digital device, pursuant to Part 15 of the FCC Rules. These limits are designed to provide reasonable protection against harmful interference in a residential installation. This equipment generates, uses and can radiate radio frequency energy and, if not installed and used in accordance with the instructions, may cause harmful interference to radio communications. However, there is no guarantee that interference will not occur in a particular installation. If this equipment does cause harmful interference to radio or television reception, which can be determined by turning the equipment off and on, the user is encouraged to try to correct the interference by one or more of the following measures:

- Reorient or relocate the receiving antenna.
- Increase the separation between the equipment and receiver.
- Connect the equipment into an outlet on a circuit different from that to which the receiver is connected.
- Consult the dealer or an experienced radio/TV technician for help.

**FCC Caution:**To assure continued compliance, follow the attached installation instructions and use only shielded interface cables when connecting to peripheral devices. Any changes or modifications not expressly approved by the party responsible for compliance could void the user's authority to operate this equipment.

This device complies with Part 15 of the FCC Rules.

Operation is subject to the following two conditions:

- (1) This device may not cause harmful interference, and
- (2) this device must accept any interference received, including interference that may cause undesired operation.

Declaration of Conformity

Trade Name: Panasonic  
Model No.: SC-BTT196  
SC-BTT195  
SC-BTT190

Responsible Party:

Panasonic Corporation of North America  
One Panasonic Way, Secaucus, NJ 07094

Support Contact:

Panasonic Consumer Marketing Company of North America  
Telephone No.: 1-800-211-PANA (7262)

**THE FOLLOWING APPLIES ONLY IN CANADA.**

This Class B digital apparatus complies with Canadian ICES-003.

Java is a registered trademark of Oracle and/or its affiliates.



Manufactured under license from Dolby Laboratories.

Dolby, Pro Logic, and the double-D symbol are trademarks of Dolby Laboratories.

Manufactured under license under U.S. Patent Nos: 5,956,674; 5,974,380; 6,226,616; 6,487,535; 7,392,195; 7,272,567; 7,333,929; 7,212,872 & other U.S. and worldwide patents issued & pending. DTS-HD, the Symbol, & DTS-HD and the Symbol together are registered trademarks & DTS-HD Master Audio | Essential is a trademark of DTS, Inc. Product includes software. © DTS, Inc. All Rights Reserved.

HDMI, the HDMI Logo, and High-Definition Multimedia Interface are trademarks or registered trademarks of HDMI Licensing LLC in the United States and other countries.

This product is licensed under the AVC patent portfolio license and VC-1 patent portfolio license for the personal and non-commercial use of a consumer to (i) encode video in compliance with the AVC Standard and VC-1 Standard ("AVC/VC-1 Video") and/or (ii) decode AVC/VC-1 Video that was encoded by a consumer engaged in a personal and non-commercial activity and/or was obtained from a video provider licensed to provide AVC/VC-1 Video. No license is granted or shall be implied for any other use. Additional information may be obtained from MPEG LA, LLC.  
See <http://www.mpegla.com>.

HDAVI Control™ is a trademark of Panasonic Corporation.

VIERA Link™ is a trademark of Panasonic Corporation.

VIERA Connect is a trademark of Panasonic Corporation.
EZ Sync™ is a trademark of Panasonic Corporation.
MPEG Layer-3 audio coding technology licensed from Fraunhofer IIS and Thomson.
"AVCHD", "AVCHD 3D", "AVCHD Progressive" and "AVCHD 3D/Progressive" are trademarks of Panasonic Corporation and Sony Corporation.
SDXC Logo is a trademark of SD-3C, LLC.
"DVD Logo" is a trademark of DVD Format/Logo Licensing Corporation.
DLNA, the DLNA Logo and DLNA CERTIFIED are trademarks, service marks, or certification marks of the Digital Living Network Alliance.
Windows is a trademark or a registered trademark of Microsoft Corporation in the United States and other countries.
Skype, associated trade marks and logos and the "S" logo are trade marks of Skype Limited.
"Wi-Fi", "Wi-Fi Protected Setup", "WPA" and "WPA2" are marks or registered marks of the Wi-Fi Alliance.
 <p>Made for iPod iPhone</p>
<p>"Made for iPod", and "Made for iPhone" mean that an electronic accessory has been designed to connect specifically to iPod, or iPhone, respectively, and has been certified by the developer to meet Apple performance standards. Apple is not responsible for the operation of this device or its compliance with safety and regulatory standards. Please note that the use of this accessory with iPod, or iPhone may affect wireless performance. iPhone, iPod, iPod classic, iPod nano, and iPod touch are trademarks of Apple Inc., registered in the U.S. and other countries.</p>
gSOAP Public License 1.3
<p>Part of the software embedded in this product is gSOAP software.  Portions created by gSOAP are Copyright (C) 2001-2009 Robert A. van Engelen, Genivia inc. All Rights Reserved.  <b>THE SOFTWARE IN THIS PRODUCT WAS IN PART PROVIDED BY GENIVIA INC AND ANY EXPRESS OR IMPLIED WARRANTIES, INCLUDING, BUT NOT LIMITED TO, THE IMPLIED WARRANTIES OF MERCHANTABILITY AND FITNESS FOR A PARTICULAR PURPOSE ARE DISCLAIMED. IN NO EVENT SHALL THE AUTHOR BE LIABLE FOR ANY DIRECT, INDIRECT, INCIDENTAL, SPECIAL, EXEMPLARY, OR CONSEQUENTIAL DAMAGES (INCLUDING, BUT NOT LIMITED TO, PROCUREMENT OF SUBSTITUTE GOODS OR SERVICES; LOSS OF USE, DATA, OR PROFITS; OR BUSINESS INTERRUPTION) HOWEVER CAUSED AND ON ANY THEORY OF LIABILITY, WHETHER IN CONTRACT, STRICT LIABILITY, OR TORT (INCLUDING NEGLIGENCE OR OTHERWISE) ARISING IN ANY WAY OUT OF THE USE OF THIS SOFTWARE, EVEN IF ADVISED OF THE POSSIBILITY OF SUCH DAMAGE.</b></p>

<p>(1) MS/WMA  This product is protected by certain intellectual property rights of Microsoft Corporation and third parties. Use or distribution of such technology outside of this product is prohibited without a license from Microsoft or an authorized Microsoft subsidiary.</p>
<p>(2) MS/PlayReady/Final Product Labeling  This product contains technology subject to certain intellectual property rights of Microsoft. Use or distribution of this technology outside of this product is prohibited without the appropriate license(s) from Microsoft.</p>
<p>(3)MS/PlayReady/End User Notices  Content owners use Microsoft PlayReady™ content access technology to protect their intellectual property, including copyrighted content. This device uses PlayReady technology to access PlayReady-protected content and/or WMDRM-protected content. If the device fails to properly enforce restrictions on content usage, content owners may require Microsoft to revoke the device's ability to consume PlayReady-protected content. Revocation should not affect unprotected content or content protected by other content access technologies. Content owners may require you to upgrade PlayReady to access their content. If you decline an upgrade, you will not be able to access content that requires the upgrade.</p>
<p>(4) Vorbis  The software license is displayed when "License" in the Setup menu is selected. (↔ 36)</p>
<p>(5) FLAC  The software license is displayed when "License" in the Setup menu is selected. (↔ 36)</p>



This product incorporates the following software:

- (1) the software developed independently by or for Panasonic Corporation,
- (2) the software owned by third party and licensed to Panasonic Corporation,
- (3) the software licensed under the GNU General Public License, Version 2 (GPL v2),
- (4) the software licensed under the GNU LESSER General Public License, Version 2.1 (LGPL v2.1) and/or,
- (5) open sourced software other than the software licensed under the GPL v2 and/or LGPL v2.1

For the software categorized as (3) and (4), please refer to the terms and conditions of GPL v2 and LGPL v2.1, as the case may be at <http://www.gnu.org/licenses/old-licenses/gpl-2.0.html> and <http://www.gnu.org/licenses/old-licenses/lgpl-2.1.html>.

In addition, the software categorized as (3) and (4) are copyrighted by several individuals. Please refer to the copyright notice of those individuals at <http://panasonic.net/avc/oss/bdplayer/AWBPP12.html>

The GPL/LGPL software is distributed in the hope that it will be useful, but WITHOUT ANY WARRANTY, without even the implied warranty of MERCHANTABILITY or FITNESS FOR A PARTICULAR PURPOSE.

At least three (3) years from delivery of products, Panasonic will give to any third party who contacts us at the contact information provided below, for a charge no more than our cost of physically performing source code distribution, a complete machine-readable copy of the corresponding source code covered under GPL v2/LGPL v2.1.

Contact Information

[cdrequest.bdplayer@gg.jp.panasonic.com](mailto:cdrequest.bdplayer@gg.jp.panasonic.com)

Source code is also freely available to you and any other member of the public via our website below.  
<http://panasonic.net/avc/oss/bdplayer/AWBPP12.html>

For the software categorized as (5) includes as follows.

1. This product includes software developed by the OpenSSL Project for use in the OpenSSL Toolkit.  
(<http://www.openssl.org>)
2. This product includes software developed by the University of California, Berkeley and its contributors.
3. FreeType code.
4. The Independent JPEG Group's JPEG software.

Copyright 2004-2010 Verance Corporation. Cinavia™ is a Verance Corporation trademark. Protected by U.S. Patent 7,369,677 and worldwide patents issued and pending under license from Verance Corporation. All rights reserved.

# Limited Warranty (ONLY FOR U.S.A. AND PUERTO RICO)

Panasonic Consumer Marketing Company of North America,  
Division of Panasonic Corporation of North America  
One Panasonic Way, Secaucus, New Jersey 07094

## Panasonic Blu-ray and DVD Products Limited Warranty

### Limited Warranty Coverage (For USA and Puerto Rico Only)

If your product does not work properly because of a defect in materials or workmanship, Panasonic Consumer Marketing Company of North America (referred to as "the warrantor") will, for the length of the period indicated on the chart below, which starts with the date of original purchase ("warranty period"), at its option either (a) repair your product with new or refurbished parts, (b) replace it with a new or a refurbished equivalent value product, or (c) refund your purchase price. The decision to repair, replace or refund will be made by the warrantor.

Product or Part Name	Parts	Labor
Blu-ray Disc Player, Portable Blu-ray Disc Player	1 year	90 days
Blu-ray Home Theater System	1 year	1 year
DVD Player, Portable DVD Player	1 year	90 days
DVD Recorder	1 year	90 days
Rechargeable Batteries (pack)	90 days	Not Applicable

During the "Labor" warranty period there will be no charge for labor. During the "Parts" warranty period, there will be no charge for parts. This Limited Warranty excludes both parts and labor for non-rechargeable batteries, antennas, and cosmetic parts (cabinet). This warranty only applies to products purchased and serviced in the United States or Puerto Rico. This warranty is extended only to the original purchaser of a new product which was not sold "as is".

### Mail-In Service

For assistance in the U.S.A. and Puerto Rico in obtaining repairs, please ship the product prepaid to:

**Panasonic Exchange Center**  
4900 George McVay Drive  
Suite B  
McAllen, TX 78503  
[panacare@us.panasonic.com](mailto:panacare@us.panasonic.com)

When shipping the unit, carefully pack, include all supplied accessories listed in the Owner's Manual, and send it prepaid, adequately insured and packed well in a carton box. When shipping Lithium Ion batteries please visit our Web Site at [www.panasonic.com/BatteryHandling](http://www.panasonic.com/BatteryHandling) as Panasonic is committed to providing the most up to date information. Include a letter detailing the complaint, a return address and provide a daytime phone number where you can be reached. A valid registered receipt is required under the Limited Warranty.

**IF REPAIR IS NEEDED DURING THE WARRANTY PERIOD, THE PURCHASER WILL BE REQUIRED TO FURNISH A SALES RECEIPT/ PROOF OF PURCHASE INDICATING DATE OF PURCHASE, AMOUNT PAID AND PLACE OF PURCHASE. CUSTOMER WILL BE CHARGED FOR THE REPAIR OF ANY UNIT RECEIVED WITHOUT SUCH PROOF OF PURCHASE.**

### Limited Warranty Limits And Exclusions

This warranty ONLY COVERS failures due to defects in materials or workmanship, and DOES NOT COVER normal wear and tear or cosmetic damage. The warranty ALSO DOES NOT COVER damages which occurred in shipment, or failures which are caused by products not supplied by the warrantor, or failures which result from accidents, misuse, abuse, neglect, mishandling, misapplication, alteration, faulty installation, set-up adjustments, misadjustment of consumer controls, improper maintenance, power line surge, lightning damage, modification, introduction of sand, humidity or liquids,

commercial use such as hotel, office, restaurant, or other business or rental use of the product, or service by anyone other than a Factory Service Center or other Authorized Servicer, or damage that is attributable to acts of God.

**THERE ARE NO EXPRESS WARRANTIES EXCEPT AS LISTED UNDER "LIMITED WARRANTY COVERAGE".**

**THE WARRANTOR IS NOT LIABLE FOR INCIDENTAL OR CONSEQUENTIAL DAMAGES RESULTING FROM THE USE OF THIS PRODUCT, OR ARISING OUT OF ANY BREACH OF THIS WARRANTY.** (As examples, this excludes damages for lost time, travel to and from the servicer, loss of or damage to media or images, data or other memory or recorded content. The items listed are not exclusive, but for illustration only.) **ALL EXPRESS AND IMPLIED WARRANTIES, INCLUDING THE WARRANTY OF MERCHANTABILITY, ARE LIMITED TO THE PERIOD OF THE LIMITED WARRANTY.**

Some states do not allow the exclusion or limitation of incidental or consequential damages, or limitations on how long an implied warranty lasts, so the exclusions may not apply to you.

This warranty gives you specific legal rights and you may also have other rights which vary from state to state. If a problem with this product develops during or after the warranty period, you may contact your dealer or Service Center. If the problem is not handled to your satisfaction, then write to the warrantor's Consumer Affairs Department at the addresses listed for the warrantor.

**PARTS AND SERVICE, WHICH ARE NOT COVERED BY THIS LIMITED WARRANTY, ARE YOUR RESPONSIBILITY.**

### Customer Services Directory (United States and Puerto Rico)

Obtain Product Information and Operating Assistance; locate your nearest Dealer or Service Center; purchase Parts and Accessories; or make Customer Service and Literature requests by visiting our Web Site at:

<http://www.panasonic.com/help>  
or, contact us via the web at:

<http://www.panasonic.com/contactinfo>

You may also contact us directly at:

1-800-211-PANA (7262)

Monday-Friday 9am-9pm,

Saturday-Sunday 10am-7pm EST

For hearing or speech impaired TTY users, TTY: 1-877-833-8855

### Accessory Purchases (United States and Puerto Rico)

Purchase Parts, Accessories and Instruction Books online for all Panasonic Products by visiting our Web Site at:

<http://www.pstc.panasonic.com>

Or, send your request by E-mail to:

[tpcparts@us.panasonic.com](mailto:tpcparts@us.panasonic.com)

You may also contact us directly at:

1-800-332-5368 (Phone) 1-800-237-9080 (Fax Only)

(Monday-Friday 9am-9pm EST)

Panasonic National Parts Center

20421 84th Ave S., Kent, WA 98032

(We accept Visa, MasterCard, Discover Card, American Express)

For hearing or speech impaired TTY users, TTY: 1-866-605-1277

As of January 2012

### User memo:

DATE OF PURCHASE \_\_\_\_\_  
DEALER NAME \_\_\_\_\_  
DEALER ADDRESS \_\_\_\_\_  
TELEPHONE NUMBER \_\_\_\_\_

The model number and serial number of this product can be found on either the back or the bottom of the unit. Please note them in the space provided below and keep for future reference.

MODEL NUMBER \_\_\_\_\_

SERIAL NUMBER \_\_\_\_\_

# Limited Warranty (Only for CANADA)

## Panasonic Canada Inc.

5770 Ambler Drive, Mississauga, Ontario L4W 2T3

### PANASONIC PRODUCT - LIMITED WARRANTY

Panasonic Canada Inc. warrants this product to be free from defects in material and workmanship under normal use and for a period as stated below from the date of original purchase agrees to, at its option either (a) repair your product with new or refurbished parts, (b) replace it with a new or a refurbished equivalent value product, or (c) refund your purchase price. The decision to repair, replace or refund will be made by Panasonic Canada Inc.

**Technics Audio Product - One (1) year, parts and labour**  
**Panasonic BD/DVD Product - One (1) year, parts and labour**  
**Panasonic Audio Receivers - One (1) year, parts and labour**  
**Home Theater Systems Product - One (1) year, parts and labour**

This warranty is given only to the original purchaser, or the person for whom it was purchased as a gift, of a Panasonic brand product mentioned above sold by an authorized Panasonic dealer in Canada and purchased and used in Canada, which product was not sold "as is", and which product was delivered to you in new condition in the original packaging.

**IN ORDER TO BE ELIGIBLE TO RECEIVE WARRANTY SERVICE HEREUNDER, A PURCHASE RECEIPT OR OTHER PROOF OF DATE OF ORIGINAL PURCHASE, SHOWING AMOUNT PAID AND PLACE OF PURCHASE IS REQUIRED**

#### LIMITATIONS AND EXCLUSIONS

This warranty **ONLY COVERS** failures due to defects in materials or workmanship, and **DOES NOT COVER** normal wear and tear or cosmetic damage. The warranty **ALSO DOES NOT COVER** damages which occurred in shipment, or failures which are caused by products not supplied by Panasonic Canada Inc., or failures which result from accidents, misuse, abuse, neglect, mishandling, misapplication, alteration, faulty installation, set-up adjustments, misadjustment of consumer controls, improper maintenance, power line surge, lightning damage, modification, introduction of sand, humidity or liquids, commercial use such as hotel, office, restaurant, or other business or rental use of the product, or service by anyone other than an Authorized Servicer, or damage that is attributable to acts of God.

Dry cell batteries are also excluded from coverage under this warranty.

THIS EXPRESS, LIMITED WARRANTY IS IN LIEU OF ALL OTHER WARRANTIES, EXPRESS OR IMPLIED, INCLUDING ANY IMPLIED WARRANTIES OF MERCHANTABILITY AND FITNESS FOR A PARTICULAR PURPOSE. IN NO EVENT WILL PANASONIC CANADA INC. BE LIABLE FOR ANY SPECIAL, INDIRECT OR CONSEQUENTIAL DAMAGES RESULTING FROM THE USE OF THIS PRODUCT OR ARISING OUT OF ANY BREACH OF ANY EXPRESS OR IMPLIED WARRANTY. (As examples, this warranty excludes damages for lost time, travel to and from the Authorized Servicer, loss of or damage to media or images, data or other memory or recorded content. This list of items is not exhaustive, but for illustration only.)

In certain instances, some jurisdictions do not allow the exclusion or limitation of incidental or consequential damages, or the exclusion of implied warranties, so the above limitations and exclusions may not be applicable. This warranty gives you specific legal rights and you may have other rights which vary depending on your province or territory.

#### WARRANTY SERVICE

For product operation and information assistance, please contact:

#### **PRODUCT OPERATION ASSISTANCE**

Customer Care Centre: Telephone #: 1-800-561-5505  
Fax #: (905) 238-2360  
Email link: "Support → contact us → email" on [www.panasonic.ca](http://www.panasonic.ca)

#### **PRODUCT REPAIRS**

Please locate your nearest Authorized Servicentre.

Link: "Support → Panasonic Servicentre® locator" on [www.panasonic.ca](http://www.panasonic.ca)

#### **IF YOU SHIP THE PRODUCT TO A SERVICENTRE**

Carefully pack and send prepaid, adequately insured and preferably in the original carton.  
Include details of the defect claimed, and proof of date of original purchase.

# Index

<b>A</b>	<b>Audio</b>				
	Changing audio .....	20			
	Language .....	28, 33			
<b>B</b>	<b>BD-Live</b> .....	21			
<b>D</b>	<b>DLNA</b> .....	27			
<b>F</b>	<b>File format</b> .....	46			
	<b>Firmware update</b> .....	16			
<b>I</b>	<b>iPod/iPhone</b> .....	22			
<b>L</b>	<b>LAN</b> .....	14			
	<b>Language</b>				
	Audio .....	33			
	Menu .....	34			
	On-screen .....	34			
	Soundtrack .....	28			
	Subtitle .....	28, 33			
<b>M</b>	<b>Media Renderer</b> .....	27			
	<b>Multi User Mode</b> .....	19			
<b>N</b>	<b>Network</b>				
	Connection .....	14			
	Setting .....	15, 34			
<b>P</b>	<b>Pop-up menu</b> .....	20			
<b>Q</b>	<b>Quick Start</b> .....	36			
<b>R</b>	<b>Radio</b> .....	25			
	<b>Re-master</b> .....	30			
	<b>Restore Default Settings</b> .....	36			
	<b>Resume play function</b> .....	20			
<b>S</b>	<b>Subtitle</b> .....	28, 33			
<b>U</b>	<b>USB device</b> .....	7			
<b>V</b>	<b>VIERA Connect</b> .....	26			
	<b>VIERA Link™ “HDAVI Control™”</b> .....	23			
<b>W</b>	<b>Wireless LAN</b> .....	14			
	24p .....	29, 32			
	3D .....	21			

## Information on Disposal in other Countries outside the European Union



This symbol is only valid in the European Union. If you wish to discard this product, please contact your local authorities or dealer and ask for the correct method of disposal.

	<b>CAUTION</b> RISK OF ELECTRIC SHOCK DO NOT OPEN	
<p>CAUTION: TO REDUCE THE RISK OF ELECTRIC SHOCK, DO NOT REMOVE SCREWS. NO USER-SERVICEABLE PARTS INSIDE. REFER SERVICING TO QUALIFIED SERVICE PERSONNEL</p>		



The lightning flash with arrowhead symbol, within an equilateral triangle, is intended to alert the user to the presence of uninsulated "dangerous voltage" within the product's enclosure that may be of sufficient magnitude to constitute a risk of electric shock to persons.



The exclamation point within an equilateral triangle is intended to alert the user to the presence of important operating and maintenance (servicing) instructions in the literature accompanying the appliance.



As an ENERGY STAR® Partner,\* Panasonic has determined that this product meets the ENERGY STAR® guidelines for energy efficiency.

\* For Canada only: The word "Participant" is used in place of the word "Partner".

Panasonic Consumer Marketing  
Company of North America,  
Division of Panasonic Corporation  
of North America

One Panasonic Way, Secaucus,  
New Jersey 07094  
<http://www.panasonic.com>

Panasonic Canada Inc.

5770 Ambler Drive  
Mississauga, Ontario  
L4W 2T3  
[www.panasonic.ca](http://www.panasonic.ca)

En

VQT3X51-2  
F1211SB2022