

**ROTINA 35
ROTINA 35 R**

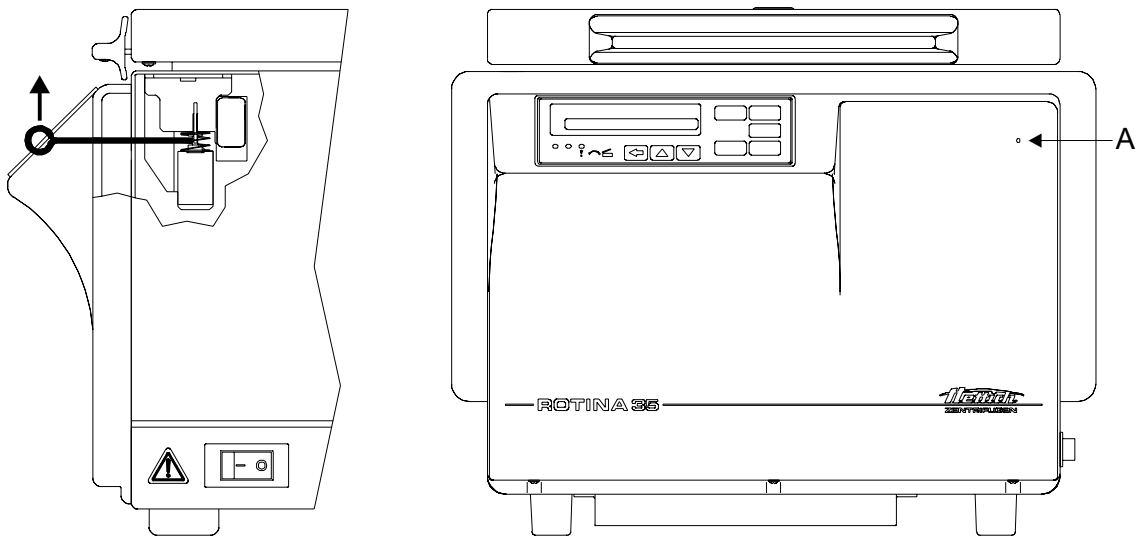

Fig. 1

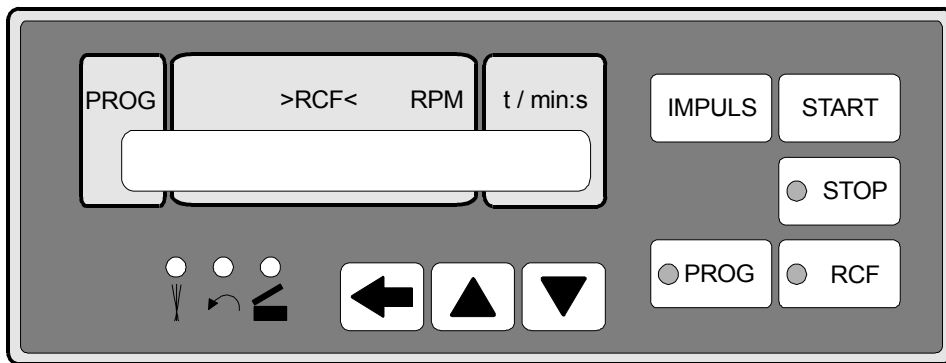

Fig. 2 ROTINA 35

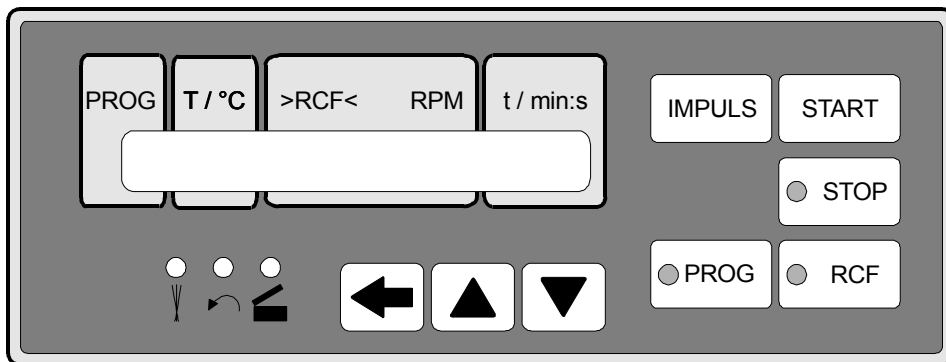

Fig. 3 ROTINA 35 R



**EG-Konformitätserklärung
EC Conformity Declaration
Déclaration de conformité CE
Dichiarazione di conformità alle norme CEE**

Andreas Hettich GmbH & Co. KG • Gartenstraße 100 • D-78532 Tuttlingen • Germany

Das bezeichnete Gerät entspricht den aufgeführten EG-Richtlinien und Normen.

The named device complies with specified EC guidelines and standards.

L'appareil ci-dessous satisfait aux directives CE et aux normes mentionnées.

L'apparecchio indicato è conforme alle direttive e norme CEE previste

Geräteart, Type of device, Type d'appareil, Tipo di apparecchio:

Laborzentrifuge, Laboratory centrifuge, Centrifugeuse de laboratoire, Centrifuga da laboratorio

Typenbezeichnung, Type designation, Désignation de modèle, Contrassegno tipo:

ROTINA 35, ROTINA 35 R

EG-Richtlinien/Normen, EC guidelines/standards, Directives CE/Normes, Direttive/Norme CEE:

98/37/EG, 89/336/EWG, 91/263/EWG, 92/31/EWG, 93/68/EWG, 73/23/EWG

EN 55011, EN 50082-1

EN 61010-1, EN 61010-2-20

Tuttlingen, 12.06.2003

ppa. H. Eberle



ROTINA 35 / ROTINA 35 R

Ⓝ DE	Bedienungsanleitung.....	1
Ⓝ EN	Operating Instructions	10
Ⓝ FR	Mode d'emploi.....	19
Ⓝ IT	Istruzioni per l'uso	28

Inhaltsverzeichnis

1	Verwendungszweck.....	2
2	Sicherheitshinweise.....	2
3	Hinweissymbole.....	3
4	Lieferumfang.....	3
5	Auspacken der Zentrifuge.....	3
6	Inbetriebnahme.....	3
7	Deckel öffnen und schließen.....	3
7.1	Deckel öffnen.....	3
7.2	Deckel schließen.....	3
8	Ein- und Ausbau des Rotors.....	4
9	Beladen des Rotors.....	4
10	Winkelrotoren aerosoldicht verschließen.....	4
11	Bedien- und Anzeigeelemente.....	4
11.1	Symbole des Bedienfeldes.....	4
11.2	Tasten des Bedienfeldes.....	4
11.3	Einstellmöglichkeiten.....	5
12	Zentrifugations-Parameter eingeben.....	5
13	Programmierung.....	5
13.1	Programm-Eingabe / -Änderung.....	5
13.2	Programm-Abruf.....	5
14	Zentrifugation.....	6
14.1	Zentrifugation mit Zeitvorwahl.....	6
14.2	Dauerlauf.....	6
14.3	Kurzzeitzentrifugation.....	6
15	Not-Stop.....	6
16	Akustisches Signal.....	6
17	Betriebsstunden-Abfrage.....	7
18	Kühlung (nur bei Zentrifuge mit Kühlung).....	7
18.1	Standby-Kühlung.....	7
18.2	Vorkühlen des Rotors.....	7
19	Zentrifugation von Stoffen mit höherer Dichte.....	7
20	Rotor-Erkennung.....	7
21	Notentriegelung.....	7
22	Pflege und Wartung.....	8
22.1	Zentrifuge.....	8
22.2	Rotoren und Zubehör.....	8
22.2.1	Tragzapfen.....	8
22.3	Autoklavieren.....	8
22.4	Glasbruch.....	8
23	Störungen.....	9
24	Reparaturannahme von Zentrifugen.....	9
25	Anhang / Appendix.....	37
25.1	Technische Daten / Technical specification.....	37
25.2	Rotoren und Zubehör / Rotors and accessories.....	38

1 Verwendungszweck

Die Zentrifuge dient zum Trennen von Stoffen bzw. Stoffgemischen mit einer Dichte von max. 1,2 kg/dm³.

2 Sicherheitshinweise



- Die Zentrifuge ist nach dem Stand der Technik gebaut und betriebssicher.
 - Es können aber von ihr Gefahren für den Benutzer oder Dritte ausgehen, wenn sie nicht von geschultem Personal oder unsachgemäß oder zu nicht bestimmungsgemäßem Gebrauch eingesetzt wird.
- Vor Inbetriebnahme der Zentrifuge ist die Bedienungsanleitung zu lesen und zu beachten.
- Neben der Bedienungsanleitung und den verbindlichen Regelungen der Unfallverhütung sind auch die anerkannten fachtechnischen Regeln für sicherheits- und fachgerechtes Arbeiten zu beachten. Die Bedienungsanleitung ist um Anweisungen aufgrund bestehender nationaler Vorschriften des Verwenderlandes zur Unfallverhütung und zum Umweltschutz zu ergänzen.
- Die Zentrifuge ist so aufzustellen, dass sie standsicher betrieben werden kann.
- Die Zentrifuge darf während des Betriebs nicht bewegt oder angestoßen werden.
- Um Schäden durch Kondensat zu vermeiden, muss bei Wechsel von einem kalten in einen warmen Raum die Zentrifuge entweder 30 Minuten im kalten Raum warmlaufen oder mindestens 3 Stunden im warmen Raum aufwärmen, bevor sie an das Netz angeschlossen werden darf.
- Zentrifugiergefäße dürfen nur mit der vom Hersteller angegebenen maximalen Füllmenge befüllt werden.
 - Die Zentrifugiergefäße sind außerhalb der Zentrifuge zu füllen.
- Standard-Zentrifugiergefäße aus Glas sind belastbar bis RZB 4000 (DIN 58970 Teil 2).
- Zentrifugiergefäße müssen in den vom Hersteller freigegebenen Reduzierungen bzw. Gestellen zentrifugiert werden (siehe Kapitel "Anhang/Appendix, Rotoren und Zubehör/Rotors and accessories").
- Bei der Zentrifugation mit maximaler Drehzahl darf die Dichte der Stoffe oder Stoffgemische 1,2 kg/dm³ nicht überschreiten.
- Zentrifugationen mit unzulässiger Unwucht sind nicht erlaubt.
- Die Zentrifuge darf nicht in explosionsgefährdeten Räumen betrieben werden.
- Eine Zentrifugation mit:
 - brennbaren oder explosiven Materialien
 - Materialien, die chemisch mit hoher Energie miteinander reagieren ist verboten.
- Bei der Zentrifugation von gefährlichen Stoffen bzw. Stoffgemischen, die toxisch, radioaktiv oder mit pathogenen Mikroorganismen verseucht sind, sind durch den Benutzer geeignete Maßnahmen zu treffen. Ohne zusätzliche Maßnahmen, wie z.B. Deckel für Zentrifugierbecher mit zusätzlicher Abdichtung, oder Winkelrotoren mit Dichtring zwischen Deckel und Rotor ist eine Zentrifuge im Sinne der Norm EN 61010-2-20 nicht mikrobiologisch dicht. Bei Materialien der Risikogruppe II (siehe Handbuch "Laboratory Biosafety Manual" der Weltgesundheitsorganisation) ist ein Bio-Sicherheitssystem zu verwenden. Bei einem Bio-Sicherheitssystem verhindert eine Bioabdichtung (Dichtring) zwischen Gehänge und Deckel das Austreten von Tröpfchen und Aerosolen. Zur Zentrifugation können auch die im Handel erhältlichen Zentrifugiergefäße mit speziellen Schraubverschlüssen für gefährliche Substanzen verwendet werden. Bei Materialien einer höheren Risikogruppe muss mehr als eine Schutzvorkehrung vorgesehen sein, d.h. Zentrifugiergefäße mit speziellen Schraubverschlüssen müssen in einem Bio-Sicherheitssystem zentrifugiert werden.
- Lieferbare Bio-Sicherheitssysteme siehe Abschnitt "Anhang/Appendix, Rotoren und Zubehör/Rotors and accessories". Im Zweifelsfall sind entsprechende Informationen beim Hersteller einzuholen.
- Der Betrieb der Zentrifuge mit stark korrodierenden Stoffen, welche die mechanische Festigkeit von Rotoren, Gehängen und Zubehörteilen beeinträchtigen können, ist nicht erlaubt.
- Rotoren, Gehänge und Zubehörteile, die starke Korrosionsspuren oder mechanische Schäden aufweisen, dürfen nicht zur Zentrifugation verwendet werden.
- Reparaturen dürfen nur von einer vom Hersteller autorisierten Person ausgeführt werden.
- Es dürfen nur Originalersatzteile und zugelassenes Originalzubehör der Firma Hettich verwendet werden.
- Im Störfall bzw. bei der Notentriegelung nie in den sich drehenden Rotor greifen.
- Die Zentrifuge ist ein Gerät der Gruppe 3 der Medizinischen Geräteverordnung MedGV.
- Sicherheitsbestimmungen nach:
 - IEC 1010-1/-2
 - DIN - EN61010 Teil 1,2
- Die Sicherheit und Zuverlässigkeit der Zentrifuge ist nur dann gewährleistet, wenn:
 - die Zentrifuge nach der Bedienungsanleitung betrieben wird.
 - die elektrische Installation, am Aufstellungsort der Zentrifuge, den Anforderungen von IEC Festlegungen entspricht.
 - vorgeschriebene Prüfungen nach UVV-VBG7z durch einen Sachkundigen durchgeführt werden.
- Bei Zentrifugen für Robotereinsatz sind unbedingt die Hinweise für den Schlüsselschalter zu beachten.

Bei Nichteinhaltung dieser Hinweise kann beim Hersteller kein Gewährleistungsanspruch geltend gemacht werden.

3 Hinweissymbole



Achtung Dokumentation beachten!



Rotor der Zentrifuge gleichmäßig beladen.
Alle Rotorplätze müssen belegt sein.



Zentrifugiergefäße nicht in der Zentrifuge füllen.

4 Lieferumfang

- 1 Anschlusskabel
- 1 Sechskant-Stiftschlüssel
- 1 Entriegelungsstift
- 1 Schmierfett für Tragzapfen
- 1 Bedienungsanleitung
- 1 Hinweisblatt Transportsicherung

Rotor(en) und das entsprechende Zubehör werden je nach Bestellung mitgeliefert.

5 Auspacken der Zentrifuge

- Den Karton nach oben abheben und die Polsterung entfernen.
- Die Zentrifuge, mit der angemessenen Anzahl von Helfern, an beiden Seiten anheben und auf den Labortisch stellen.



Nicht an der Frontblende anheben.

6 Inbetriebnahme

- Gemäß der Laborgerätenorm EN 61010-2-20 muss in der Hausinstallation ein Notausschalter zur Trennung der Netzversorgung im Fehlerfall angebracht sein.
Dieser Schalter muss abseits der Zentrifuge angebracht sein, vorzugsweise außerhalb des Raumes, in dem sich die Zentrifuge befindet, oder neben dem Ausgang dieses Raumes.
- Die Zentrifuge an einem geeigneten Platz standsicher aufstellen und nivellieren. Bei der Aufstellung ist der geforderte Sicherheitsbereich, gemäß IEC 1010-2-2, von 300 mm um die Zentrifuge herum, zu beachten.



Während die Zentrifuge in Betrieb ist dürfen sich keine Personen und Gefahrstoffe im Sicherheitsbereich befinden.

- Lüftungsöffnungen dürfen nicht zugestellt werden.
Es muss ein Lüftungsabstand von 300 mm um die Lüftungsschlitze oder Lüftungsöffnungen eingehalten werden.
- Prüfen ob die Netzspannung mit der Angabe auf dem Typenschild übereinstimmt.
- Die Zentrifuge mit dem Anschlusskabel an eine genormte Netzsteckdose anschließen.
- Den Netzschalter einschalten. Schalterstellung "I".
Der Maschinentyp und die Programmversion werden angezeigt und nach 8 s erfolgt die Anzeige der zuletzt benutzten Zentrifugierdaten.
- Den Deckel öffnen.
- Die Transportsicherung entfernen, siehe Hinweisblatt " Transportsicherung".

7 Deckel öffnen und schließen

7.1 Deckel öffnen

- Die Griffleiste am Deckel nach oben schwenken. Die LED  erlischt.
- Den Deckel öffnen.



Der Deckel lässt sich nur öffnen, wenn die Zentrifuge eingeschaltet ist und der Rotor stillsteht.
Sollte dies nicht möglich sein, siehe Kapitel "Notentriegelung".

7.2 Deckel schließen

- Den Deckel auflegen und die Griffleiste am Deckel nach unten schwenken. Die LED  leuchtet.



Den Deckel nicht zuschlagen.

8 Ein- und Ausbau des Rotors

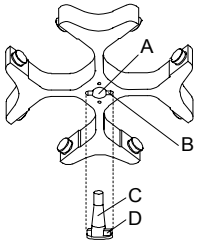

Fig. 4

- Die Motorwelle (C) und die Bohrung des Rotors (A) reinigen und anschließend die Motorwelle leicht einfetten. Schmutzpartikel zwischen der Motorwelle und dem Rotor verhindern einen einwandfreien Sitz des Rotors und verursachen einen unruhigen Lauf.
- Den Rotor vertikal auf die Motorwelle aufsetzen. Der Mitnehmer der Motorwelle (D) muss sich in der Nut des Rotors (B) befinden. Auf dem Rotor ist die Ausrichtung der Nut gekennzeichnet.
- Die Spannmutter des Rotors mit dem mitgelieferten Schlüssel durch Drehen im Uhrzeigersinn anziehen.
- Den Rotor auf festen Sitz prüfen.
- Lösen des Rotors: Die Spannmutter durch Drehen entgegen dem Uhrzeigersinn lösen und bis zum Abhebe-Druckpunkt drehen. Nach Überwindung des Abhebe-Druckpunkts löst sich der Rotor vom Konus der Motorwelle. Die Spannmutter drehen, bis sich der Rotor von der Motorwelle abheben lässt.

9 Beladen des Rotors

- Bei Ausschwingrotoren müssen alle Rotorplätze mit Gehängen belegt sein.
- Die Rotoren und Gehänge dürfen nur symmetrisch beladen werden. Zugelassene Kombinationen siehe Kapitel "Anhang/Appendix, Rotoren und Zubehör/Rotors and accessories".
- Bei Behältern mit Gummieinlagen muss sich unter den Zentrifugiergefäßen immer die gleiche Anzahl von Gummieinlagen befinden.
- Die Zentrifugiergefäße immer außerhalb der Zentrifuge befüllen.
- Es darf beim Füllen und beim Ausschwingen der Gehänge keine Flüssigkeit in den Schleuderraum gelangen.
- Um die Gewichtsunterschiede innerhalb der Zentrifugiergefäße möglichst gering zu halten, ist auf eine gleichmäßige Füllhöhe in den Gefäßen zu achten.
- Auf jedem Rotor ist das Gewicht der zulässigen Füllmenge angegeben. Dieses Gewicht darf nicht überschritten werden.

10 Winkelrotoren aerosoldicht verschließen

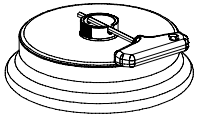

Fig. 5

Um Aerosoldichtigkeit zu gewährleisten, müssen die Deckel von aerosoldichten Winkelrotoren mit Hilfe des mitgelieferten Schlüssels festgeschraubt werden.

Zum Festschrauben oder Lösen des Deckels den mitgelieferten Schlüssel durch die Bohrung im Deckel stecken, siehe Fig. 5.

Lieferbare aerosoldichte Winkelrotoren siehe Kapitel "Anhang/Appendix, Rotoren und Zubehör/Rotors and accessories".

11 Bedien- und Anzeigeelemente

Bitte die Rückseite des Deckblattes aufschlagen.

Fig. 2, Fig. 3: Anzeige- und Bedienfeld

11.1 Symbole des Bedienfeldes



Unwuchtanzeige. Die Unwuchtanzeige leuchtet, wenn der zulässige Gewichtsunterschied innerhalb der Beladung des Rotors überschritten wurde.



Rotationsanzeige. Die Rotationsanzeige leuchtet während des Zentrifugationslaufes, solange der Rotor dreht.



Deckelanzeige. Die Deckelanzeige leuchtet wenn der Deckel geschlossen und verriegelt ist. Während des Zentrifugationslaufes erlischt die Deckelanzeige.

Bedienfehler bzw. auftretende Störungen werden im Display symbolisiert (siehe Kapitel "Störungen").

11.2 Tasten des Bedienfeldes



Wähltaste zum Anwählen der einzelnen Parameter.
Durch jeden weiteren Tastendruck wird der nachfolgende Parameter angewählt.



Durch Drücken der Pfeiltasten wird der Wert eines zuvor angewählten Parameters erhöht oder verkleinert. Bei Gedrückthalten einer Pfeiltaste erhöht oder verkleinert sich der Wert mit zunehmender Geschwindigkeit.



Zentrifugationslauf starten. Die Rotationsanzeige  leuchtet.
Übernahme von Eingaben und Änderungen.



Zentrifugationslauf beenden.
Der Rotor läuft mit vorgewählter Bremsstufe aus. Die LED in der Taste leuchtet bis der Rotor stillsteht.
Zweimaliges Drücken der Taste löst den NOT-STOP aus.



Anwählen der RCF-Anzeige.
Die LED in der Taste leuchtet.



Kurzzeitzentrifugation.
Der Zentrifugationslauf erfolgt, solange die Taste gedrückt gehalten wird.



Speichern und Abrufen von Programmen.
Durch jeden weiteren Tastendruck wird das nachfolgende Programm angezeigt (1 - 2 - 3 - #)

11.3 Einstellmöglichkeiten

t/min	Einstellbar von 1 - 99 min, in 1 min-Schritten.
t/sec	Einstellbar von 1 - 59 s, in 1 Sekunden-Schritten.
∞	Dauerlauf.
RPM	Drehzahl. Einstellbar ist ein Zahlenwert von 500 RPM bis zur maximalen Drehzahl des Rotors. Maximale Drehzahl des Rotors siehe Kapitel "Anhang/Appendix, Rotoren und Zubehör/Rotors and accessories". Einstellbar von 500 RPM bis 10000 RPM in 10er Schritten und ab 10000 RPM bis zur maximalen Drehzahl in 100er Schritten.
RAD/mm	Zentrifugierradius. Eingabe in mm. Zentrifugierradius siehe Kapitel "Anhang/Appendix, Rotoren und Zubehör/Rotors and accessories". Die Eingabe des Radius ist nur möglich, wenn die RCF-Anzeige angewählt ist (LED in der Taste leuchtet).
RCF	Relative Zentrifugalbeschleunigung. Einstellbar ist ein Zahlenwert, der eine Drehzahl zwischen 500 RPM und der maximalen Drehzahl des Rotors ergibt. Einstellbar bis 100 in 1er Schritten und ab 100 in 10er Schritten. Der RCF-Wert wird automatisch auf den Drehzahlschritt auf- bzw. abgerundet. Die Eingabe der RCF ist nur möglich, wenn die RCF-Anzeige angewählt ist (LED in der Taste leuchtet).
	Anlaufstufen 1 - 9. Stufe 9 = kürzeste Anlaufzeit, Stufe 1 = längste Anlaufzeit.
	Bremsstufen 0 - 9. Stufe 9 = kürzeste Auslaufzeit, Stufe 1 = lange Auslaufzeit, Stufe 0 = längste Auslaufzeit (ungebremster Auslauf).
T/°C	Temperatur-Sollwert (nur bei Zentrifuge mit Kühlung). Einstellbar von -20°C bis +40°C, in 1°C-Schritten. Die tiefste erreichbare Temperatur ist rotorabhängig (siehe Kapitel "Anhang/Appendix, Rotoren und Zubehör/Rotors and accessories").
PROG	Programm-Nummer. Es können 3 Programme gespeichert werden (Programmplätze 1 - 2 - 3). Der Programmplatz # dient als Zwischenspeicher für geänderte Einstellungen.

12 Zentrifugations-Parameter eingeben



Wird nach der Anwahl oder während der Eingabe von Parametern 8 Sekunden lang keine Taste gedrückt, werden in der Anzeige wieder die vorherigen Werte angezeigt. Die Eingabe der Parameter muss dann erneut durchgeführt werden.

- Mit der Taste die RPM- oder RCF-Anzeige anwählen. Ist die RCF-Anzeige angewählt, so leuchtet die LED in der Taste .
- Mit der Taste die gewünschten Parameter anwählen und mit den Tasten einstellen. Um das Symbol ∞ einzustellen müssen die Parameter **t/min** und **t/sec** mit der Taste auf Null gestellt werden.
- Nach der Eingabe aller Parameter die Taste drücken, um die Einstellungen auf Programmplatz # zu speichern. Als Bestätigung wird kurzzeitig ***** ok ***** angezeigt.



Die Daten auf Programmplatz # werden bei jeder Eingabe von Parametern und Drücken der Taste überschrieben.

13 Programmierung

13.1 Programm-Eingabe / -Änderung

- Mit der Taste die RPM- oder RCF-Anzeige anwählen. Ist die RCF-Anzeige angewählt, so leuchtet die LED in der Taste .
- Mit der Taste die gewünschten Parameter anwählen und mit den Tasten einstellen.
- Mit der Taste den Parameter **PROG** anwählen und mit den Tasten den gewünschten Programmplatz einstellen. Die LED in der Taste leuchtet.
- Die Taste drücken, um die Einstellungen auf dem gewünschten Programmplatz zu speichern. Als Bestätigung wird kurzzeitig ***** ok ***** angezeigt.

13.2 Programm-Abruf

- Den gewünschten Programmplatz durch Drücken der Taste anwählen. Die Zentrifugations-Daten des angewählten Programmplatzes werden angezeigt.
- Die Parameter können durch Drücken der Taste überprüft werden.

14 Zentrifugation



Wird der zulässige Gewichtsunterschied innerhalb der Beladung des Rotors überschritten, schaltet der Antrieb während des Anlaufs ab, die Unwuchtanzeige leuchtet auf und **IMBALANCE** wird angezeigt.

Ist die Drehzahl im angewählten Programm höher als die maximale Drehzahl des Rotors, kann kein Zentrifugationslauf gestartet werden. Es wird **N > ROTOR MAX** angezeigt (siehe Kapitel "Störungen").

Ein Zentrifugationslauf kann jederzeit durch Drücken der Taste **STOP** abgebrochen werden.

Während des Zentrifugationslaufes können alle Parameter angewählt und geändert werden (siehe Kapitel "Zentrifugations-Parameter eingeben").

Mit der Taste **RCF** kann jederzeit zwischen der RPM- und RCF-Anzeige umgeschaltet werden. Wird mit der RCF-Anzeige gearbeitet, ist die Eingabe des Zentrifugerradius notwendig.

Wird **OPEN** **OFFNEN** angezeigt, so ist eine weitere Bedienung der Zentrifuge erst nach einmaligem Öffnen des Deckels möglich.

- Den Netzschalter einschalten. Schalterstellung I.
- Den Rotor beladen und den Zentrifugendeckel schließen.

14.1 Zentrifugation mit Zeitvorwahl

- Zeit einstellen oder ein Programm mit Zeitvorwahl abrufen (siehe Kapitel "Zentrifugations-Parameter eingeben" oder "Programm-Abruf").
- Die Taste **START** drücken. Die Rotationsanzeige  leuchtet solange der Rotor dreht.
- Nach Ablauf der Zeit oder bei Abbruch des Zentrifugationslaufes durch Drücken der Taste **STOP**, erfolgt der Auslauf mit der angewählten Bremsstufe. Die Bremsstufe wird angezeigt.

Während des Zentrifugationslaufes werden die Drehzahl des Rotors oder der daraus resultierende RCF-Wert, die Proben-Temperatur (nur bei Zentrifuge mit Kühlung), und die verbleibende Zeit angezeigt.

14.2 Dauerlauf

- Symbol ∞ einstellen oder ein Dauerlauf-Programm abrufen (siehe Kapitel "Zentrifugations-Parameter eingeben" oder "Programm-Abruf").
- Die Taste **START** drücken. Die Rotationsanzeige  leuchtet solange der Rotor dreht. Die Zeitählung beginnt bei 00:00.
- Die Taste **STOP** drücken um den Zentrifugationslauf zu beenden. Der Auslauf erfolgt mit der angewählten Bremsstufe. Die Bremsstufe wird angezeigt.

Während des Zentrifugationslaufes werden die Drehzahl des Rotors oder der daraus resultierende RCF-Wert, die Proben-Temperatur (nur bei Zentrifuge mit Kühlung), und die gelaufene Zeit angezeigt.

14.3 Kurzzeitzentrifugation

- Die Taste **IMPULS** gedrückt halten. Die Rotationsanzeige  leuchtet solange der Rotor dreht.
- Die Taste **IMPULS** wieder loslassen um den Zentrifugationslauf zu beenden. Der Auslauf erfolgt mit der angewählten Bremsstufe. Die Bremsstufe wird angezeigt.

Während des Zentrifugationslaufes werden die Drehzahl des Rotors oder der daraus resultierende RCF-Wert, die Proben-Temperatur (nur bei Zentrifuge mit Kühlung), und die gelaufene Zeit angezeigt.

15 Not-Stop

- Die Taste **STOP** 2x drücken.

Beim Not-Stop erfolgt der Auslauf mit Bremsstufe 9 (kürzeste Auslaufzeit). Die Bremsstufe 9 wird angezeigt. War die Bremsstufe 0 vorgewählt, so ist die Auslaufzeit technisch bedingt länger als mit Bremsstufe 9.



16 Akustisches Signal

Das akustische Signal ertönt:

- bei Auftreten einer Störung im 3 s-Intervall.
- nach Beendigung des Zentrifugationslaufes und Stillstand des Rotors im 30 s-Intervall.





Durch Öffnen des Deckels oder Drücken einer beliebigen Taste wird das akustische Signal beendet.

Das Signal nach Beendigung des Zentrifugationslaufes kann, bei Stillstand des Rotors, folgendermaßen aktiviert oder deaktiviert werden:

- Die Taste  8 s gedrückt halten.
Nach 8 s erscheint **SOUND / BELL** in der Anzeige.
- Mit der Taste  oder  **OFF** (aus) oder **ON** (ein) einstellen.
- Die Taste **START** drücken um die Einstellung zu speichern.
Als Bestätigung wird kurzzeitig ***** ok ***** angezeigt.

17 Betriebsstunden-Abfrage

Die Abfrage der Betriebsstunden ist nur bei Stillstand des Rotors möglich.

- Die Taste  8 s gedrückt halten.
Nach 8 s erscheint **SOUND / BELL** in der Anzeige.
- Die Taste  nochmals drücken.
Die Betriebsstunden (**CONTROL:**) der Zentrifuge werden angezeigt.
- Zum Verlassen der Betriebsstunden-Abfrage die Taste  oder  drücken.

18 Kühlung (nur bei Zentrifuge mit Kühlung)

Der Temperatur-Sollwert kann von -20°C bis +40°C eingestellt werden. Die tiefste erreichbare Temperatur ist rotorabhängig (siehe Kapitel "Anhang/Appendix, Rotoren und Zubehör/Rotors and accessories").

18.1 Standby-Kühlung

Bei Stillstand des Rotors und geschlossenem Deckel wird der Schleuderraum auf die vorgewählte Temperatur gekühlt. Im Display wird der Temperatur-Sollwert angezeigt.

18.2 Vorkühlen des Rotors

Zum schnellen Vorkühlen des unbeladenen Rotors und des Zubehörs, empfiehlt sich ein Zentrifugationslauf mit den Einstellungen Dauerlauf und einer Drehzahl von ca. 20% der maximalen Drehzahl des Rotors.

19 Zentrifugation von Stoffen mit höherer Dichte

Die Rotoren sind so konstruiert, dass sie bei angegebener Nenndrehzahl Stoffe mit einer durchschnittlichen homogenen Dichte von max. 1,2 kg/dm³ zentrifugieren können. Stoffe mit einer höheren Dichte müssen mit reduzierter Drehzahl zentrifugiert werden.

Die erlaubte Drehzahl lässt sich nach folgender Formel berechnen:

$$\text{Reduzierte Drehzahl (n}_{\text{red}}) = \sqrt{\frac{1,2}{\text{höhere Dichte}}} \times \text{Nenndrehzahl}$$

z.B.: RPM 4000, Dichte 1,6 kg/dm³



$$n_{\text{red}} = \sqrt{\frac{1,2}{1,6}} \times 4000 = 3464 \text{ RPM}$$

Bei eventuellen Unklarheiten ist Auskunft beim Hersteller einzuholen.

20 Rotor-Erkennung

Nach jedem Start eines Zentrifugationslaufes wird der eingesetzte Rotor erkannt.

Nach einem Rotorwechsel schaltet der Antrieb ab und die maximale Drehzahl sowie der Rotorcode des Rotors werden kurzzeitig angezeigt.

Anschließend wird  OPEN  OEFFNEN angezeigt und eine weitere Bedienung der Zentrifuge ist erst nach einmaligem Öffnen des Deckels möglich.

Wenn nach einem Rotorwechsel die maximale Drehzahl des Rotors kleiner als die eingestellte Drehzahl ist, wird die Drehzahl auf die maximale Drehzahl des Rotors begrenzt.

21 Notentriegelung

Bei einem Stromausfall kann der Deckel nicht geöffnet werden. Es muss eine Notentriegelung von Hand durchgeführt werden.



Zur Notentriegelung die Zentrifuge vom Netz trennen.
Den Deckel nur bei Stillstand des Rotors öffnen.

Bitte die Rückseite des Deckblattes aufschlagen.

- Den Entriegelungsstift (siehe Lieferumfang) waagrecht in die Bohrung einführen (Fig. 1, A). Den Entriegelungsstift so weit hineinschieben, bis sich beim nach oben Drücken des Stiftes die Griffleiste nach oben schwenken lässt.
- Den Deckel öffnen.

22 Pflege und Wartung



Vor der Reinigung den Netzstecker ziehen.

Bevor ein anderes als das vom Hersteller empfohlene Reinigungs- oder Dekontaminationsverfahren angewandt wird, hat sich der Benutzer beim Hersteller zu vergewissern, dass das vorgesehene Verfahren das Gerät nicht schädigt.

- Es sind Reinigungs- oder Desinfektionsmittel zu verwenden, die im pH-Bereich 6 - 8 liegen. Alkalische Reinigungsmittel mit einem pH-Wert > 8 sind zu vermeiden.
- Um Korrosionserscheinungen durch Reinigungs- oder Desinfektionsmittel zu vermeiden sind die speziellen Anwendungshinweise vom Hersteller des Reinigungs- oder Desinfektionsmittels unbedingt zu beachten.

22.1 Zentrifuge

- Das Gehäuse der Zentrifuge und den Schleuderraum regelmäßig säubern und bei Bedarf mit Seife oder einem milden Reinigungsmittel und Wasser reinigen. Dies dient zum einen der Hygiene und es verhindert Korrosion durch anhaftende Verunreinigungen.
- Bei Bildung von Kondenswasser den Schleuderraum, durch Auswischen mit einem saugfähigen Tuch, trocknen.
- Gelangt infektiöses Material in den Schleuderraum, so ist dieser umgehend zu desinfizieren.
- Die Gummidichtung des Schleuderraums nach jeder Reinigung leicht einfetten.

22.2 Rotoren und Zubehör

- Um einer Korrosion und Materialveränderungen vorzubeugen müssen die Rotoren und die Zubehörteile regelmäßig mit Seife oder einem milden Reinigungsmittel und Wasser gereinigt werden. Die Reinigung wird mindestens einmal wöchentlich, noch besser nach jedem Gebrauch empfohlen.
- Sind der Rotor oder die Zubehörteile durch pathogenes oder radioaktives Material verunreinigt, so muss eine geeignete Reinigung durchgeführt werden.
- Die Rotoren und Zubehörteile müssen unmittelbar nach der Reinigung getrocknet werden.
- Winkelrotoren, Behälter und Gehänge aus Aluminium sind nach dem Trocknen leicht einzufetten (Hettich-Schmierfett Best.-Nr. 4051).
- Bei aerosoldichten Rotoren und Bio-Sicherheitssystemen (siehe Kapitel "Anhang/Appendix, Rotoren und Zubehör/Rotors and accessories") sind die Dichtungsringe regelmäßig (wöchentlich) zu prüfen und zu reinigen. Bei Anzeichen von Rissbildung, Versprödung oder Abnutzung ist der Dichtungsring sofort auszutauschen.
- Um Korrosion infolge Feuchtigkeit zwischen Rotor und Motorwelle zu verhindern, sollte der Rotor mindestens einmal im Monat ausgebaut, gereinigt und die Motorwelle leicht gefettet werden.
- Die Rotoren und die Zubehörteile sind monatlich auf Korrosionsschäden zu überprüfen.



Rotoren und Zubehör dürfen bei Anzeichen von Verschleiß oder Korrosion nicht mehr verwendet werden.

22.2.1 Tragzapfen

Bei Ausschwingrotoren müssen die Tragzapfen regelmäßig gefettet werden (Hettich-Schmierfett Nr. 4051), um ein gleichmäßiges Ausschwingen der Gehänge zu gewährleisten.

22.3 Autoklavieren

Ausschwingrotoren, Winkelrotoren aus Aluminium und das Zubehör können bei 121°C (20 min) autoklaviert werden.



Die Deckel der Rotoren und Behälter müssen vor dem Autoklavieren abgenommen werden.

Das Autoklavieren beschleunigt den Alterungsprozess von Kunststoffen. Außerdem kann es bei Kunststoffen Farbveränderungen verursachen.

22.4 Glasbruch

- Bei Glasbruch sind die Glassplitter und ausgelaufenes Zentrifugiergut aus dem Schleuderraum und aus den Behältern oder Bohrungen der Behälter sorgfältig zu entfernen.
- Die Gummieinlagen ersetzen.



Die Gummieinlagen der Behälter müssen nach einem Glasbruch ersetzt werden, denn verbleibende Glassplitter in Gummieinlagen verursachen weiteren Glasbruch.

- Handelt es sich um infektiöses Material so ist umgehend eine Desinfektion durchzuführen.

23 Störungen

Lässt sich der Fehler nach der Störungstabelle nicht beheben, und erscheint nach NETZ-RESET die Fehlermeldung erneut in der Anzeige, so ist der Hettich-Kundendienst zu benachrichtigen.

Bitte den Zentrifugentyp und die Werknummer angeben. Beide Werte sind auf dem Typenschild der Zentrifuge ersichtlich.

NETZ-RESET: - Netzschalter AUS, länger 10s.
- Netzschalter EIN.

Anzeige		Ursache	Beseitigung
keine Anzeige	---	- keine Spannung. - Auslösen der Überstromsicherung.	- Versorgungsspannung überprüfen. - Netzschalter EIN.
TACHO - ERROR	01	- Tacho defekt.	- Deckel öffnen.
	02	- Kein Rotor eingebaut. - Motor, Umrichter, Antrieb defekt.	- Rotor von Hand drehen. - NETZ-RESET, beim Einschalten muss sich der Rotor drehen.
IMBALANCE	---	Unwucht an der Motorachse durch Gewichtsunterschieden in der Rotorbestückung.	- Deckel öffnen. - Unwucht beseitigen.
CONTROL - ERROR	04, 06 - 09	Fehler Deckelverriegelung	- Deckel öffnen. - NETZ-RESET
N > MAX	05	Überdrehzahl	
N < MIN	13	Unterdrehzahl	
ROTORCODE	10	Fehler Rotorcodierung	
MAINS INTERRUPT	---	Netzunterbrechung, Zentrifugation nicht beendet	- Deckel öffnen. - Taste START drücken.
VERSIONS-ERROR	12	Keine Übereinstimmung der Elektronik-Komponenten	- Deckel öffnen. - NETZ-RESET
CONTROL-ERROR	21 - 27	Fehler / Defekt Steuergerät	
SER I/O - ERROR	30 - 38	Fehler / Defekt Schnittstelle	
° C * - ERROR	50 - 56	Fehler / Defekt Kühlung	
LOCK - ERROR	57	Fehler / Defekt Programm-Verriegelung	
FU / CCI - ERROR	60 - 83	Fehler / Defekt Motorsteuerung	
N > ROTOR-MAX	---	Drehzahl im angewählten Programm größer als die maximale Drehzahl des Rotors.	- Drehzahl überprüfen und korrigieren.

24 Reparaturannahme von Zentrifugen

Wird die Zentrifuge zur Reparatur an den Hersteller zurückgesandt, so muss diese, zum Schutz von Personen, Umwelt und Material, vor dem Versand dekontaminiert und gereinigt werden.

Eine Annahme von kontaminierten Zentrifugen behalten wir uns vor.

Anfallende Kosten für Reinigungs- und Desinfektionsmaßnahmen werden dem Kunden in Rechnung gestellt.

Wir bitten dafür um Ihr Verständnis.

Weitere Informationen finden Sie auf unserer Homepage <http://www.HettichLab.com>

Contents

1	Intended application	11
2	Notes on safety	11
3	Warning symbols	12
4	Delivery checklist.....	12
5	Unpacking the centrifuge.....	12
6	Initial operation	12
7	Opening and closing the lid	12
7.1	Opening the lid.....	12
7.2	Closing the lid	12
8	Installation and removal of the rotor	13
9	Loading the rotor	13
10	Making angle rotors aerosol-proof.....	13
11	Control and display elements	13
11.1	Control panel symbols	13
11.2	Control panel pushbuttons (keys)	13
11.3	Adjustment possibilities.....	14
12	Entering centrifugation parameter	14
13	Programming.....	14
13.1	Programme input/alteration.....	14
13.2	Programme recall.....	14
14	Centrifugation	15
14.1	Centrifugation with pre-set time	15
14.2	Continuous run.....	15
14.3	Short-term centrifugation	15
15	Emergency Stop.....	15
16	Acoustic Signal.....	15
17	Recall hours of operation.....	16
18	Cooling (only in centrifuges with cooling)	16
18.1	Standby-cooling	16
18.2	Pre-cooling the rotor	16
19	Centrifugation of materials with higher density	16
20	Rotor Identification.....	16
21	Emergency release.....	16
22	Maintenance and servicing	17
22.1	Centrifuge	17
22.2	Rotors and Attachments	17
22.2.1	Supporting lugs	17
22.3	Autoclaving	17
22.4	Broken glass	17
23	Faults.....	18
24	Acceptance of the centrifuges for repair	18
25	Anhang / Appendix	37
25.1	Technische Daten / Technical specification	37
25.2	Rotoren und Zubehör / Rotors and accessories	38

1 Intended application

The centrifuge is used for separating substances or mixtures with a density of up to max. 1.2 kg/dm³.

2 Notes on safety



- This centrifuge is a state-of-the-art piece of equipment which is extremely safe to operate.
 - However, it can lead to danger for users or others if used by untrained staff, in an inappropriate way or for a purpose other than that it was designed for.
- Before the initial operation of your centrifuge you should read and pay attention to the operating instructions.
- Along with the operating instructions and the legal regulations on accident prevention, you should also follow the recognised professional regulations for working in a safe and professional manner.

These operating instructions should be read in conjunction with any other instructions concerning accident prevention and environmental protection based on the national regulations of the country where the device is to be used.
- The centrifuge should be installed on a good, stable base.
- The centrifuge must not be moved or knocked during operation.
- To avoid damage due to condensate, when changing from a cold to a warm room the centrifuge must either run hot in the cold room for 30 minutes, or warm up for 3 hours in the warm room, before connecting to the mains.
- Centrifuge containers must not be filled beyond the capacity specified by the manufacturer.
 - Centrifuge containers should only be filled outside the centrifuge.
- Standard centrifuge containers of glass will not stand RCF values exceeding 4000 (DIN 58970, pg. 2)
- Centrifuge containers may only be centrifuged with accessories (reducing adapters, frames, suspensions, etc.) authorised by the manufacturer (see section "Anhang/Appendix, Rotoren und Zubehör/Rotors and accessories").
- When centrifuging with maxim revolutions per minute the density of the materials or the material mixtures may not exceed 1.2 kg/dm³.
- The centrifuge may only be operated when the balance is within the bounds of acceptability.
- The centrifuge must not be operated in areas subject to danger of explosions.
- The centrifuge must not be used with:
 - inflammable or explosive materials
 - materials that react with one another producing a lot of energy.
- If users have to centrifuge hazardous materials or compounds contaminated with toxic, radioactive or pathogenic micro-organisms, they must take appropriate measures.

Without additional proceedings (like an additional bioseal between bucket and lid of bucket or angle rotor with a special bioseal between rotor and lid) a centrifuge is not a biosafety system in accordance to the regulation EN 61010-2-20. In the case of material belonging to risk group II (see the World Health Organisation's "Laboratory Biosafety Manual") they should employ a biosafety system. Under this system small drips and aerosols are prevented from escaping by a bioseal (packing ring) located between the hanger and the lid. Centrifuge containers with special screw caps, as obtainable through trade suppliers, can also be used for hazardous substances.

In the case of materials from the higher risk groups greater safety provision is required than the arrangements described above. In a biosafety system, centrifuge containers with special screw caps must be used.
- For further details of available biosafety systems see section "Anhang/Appendix, Rotoren und Zubehör/Rotors and accessories". If in doubt, you should obtain relevant information from the manufacturer.
- The centrifuge must not be operated with highly corrosive substances which could impair the mechanical integrity of rotors, hangers and accessories.
- Any rotors, hangers or accessories showing clear signs of corrosion or mechanical defects must not be used for centrifuging.
- Repairs must only be carried out by personnel authorised to do so by the manufacturer.
- Only original spare parts and original accessories licensed by the Hettich company are allowed to be utilised.
- In case of fault or emergency release, never touch the rotor before it has stopped turning.
- This centrifuge is classified in Germany as a Group 3 device according to the *Medizinische Geräteverordnung MedGV* (the regulations on medical equipment).
- It conforms to safety regulations based on:
 - IEC 1010-1/-2
 - DIN - EN61010 Parts 1and 2
- The safe operation and reliability of the centrifuge can only be guaranteed if:
 - the centrifuge is operated in accordance with the operating instructions,
 - the electrical installation on the site where the centrifuge is installed conforms to the demands of IEC stipulations,
 - prescribed tests to UVV-VBG7z are carried out by an expert.
- With centrifuges for robotic use please pay attention to the notes of the key operated switch.

No claim under guarantee will be considered by the manufacturer unless the above instructions have been adhered to.

3 Warning symbols



Caution! Follow instructions carefully.



Load centrifuge rotor evenly.
All positions on rotor must be filled.



Do not fill centrifuge containers inside the centrifuge.

4 Delivery checklist

- 1 Connecting cable
- 1 Hex. pin driver
- 1 Release pin
- 1 Lubricating grease for supporting lugs
- 1 Operating instructions
- 1 Notes on moving the equipment safely

The rotor(s) and associated accessories are included in the delivery in the quantity ordered.

5 Unpacking the centrifuge

- Lift the carton upward and remove the padding.
- Lift the centrifuge on both sides with an appropriate number of helpers and place it on the laboratory table.



Do not lift by the front panel.

6 Initial operation

- According to the laboratory instrument standards EN 61010-2-20 an emergency switch to separate power supply in the event of a failure must be installed in the building electrical system.
This switch has to be placed remote from the centrifuge, preferred outside of the room in which the centrifuge is installed or near by the exit of this room.
- Position the centrifuge in a stable and level manner in a suitable place. When setting up the equipment, care should be taken to provide the required safety area of 300 mm around the centrifuge in accordance with IEC 1010-2-2.



While the centrifuge is in operation no individuals and hazardous materials are allowed to be in the safety zone.

- Do not place any object in front of the ventiduct.
Keep a ventilation area of 300 mm around the ventiduct.
- Check whether the mains voltage tallies with the statement on the type plate.
- Connect the centrifuge with the connection cable to a standard mains socket.
- Turn on the mains switch. Switch position "I".
The type of machine and programme version will be displayed, and after 8 seconds the last utilised centrifuging data will be displayed.
- Open the lid.
- Remove the transport safety device (see instruction sheet on "Moving the equipment safely").

7 Opening and closing the lid

7.1 Opening the lid

- Swing handle rail on the lid upwards. The  LED will now go off.
- Open the lid.



The lid can only be opened when the centrifuge is switched on and the rotor is at rest. If it cannot be opened under these circumstances, see the section on "Emergency release".

7.2 Closing the lid

- Place the lid and swing handle rail on the lid downward. The  LED will come on.



Do not bang the lid shut.

8 Installation and removal of the rotor

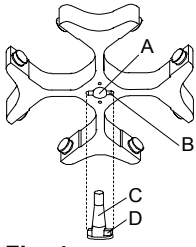

Fig. 4

- Clean the motor shaft (C) and the rotor drilling (A), and lightly grease the motor shaft afterwards. Dirt particles between the motor shaft and the rotor hinder a perfect seating of the rotor and cause an irregular operation.
- Place the rotor vertically on the motor shaft. The motor shaft dog (D) has to fit in the rotor slot (B). The alignment of the groove is labelled on the rotor.
- Tighten the rotor tension nut with the supplied wrench by turning in a clockwise direction.
- Check the rotor for firm seating.
- Loosening the rotor: Loosen the tension nut by turning in a counter clockwise direction, and turning until the working point for lifting. After passing the working point for lifting the rotor is loosened from the motor shaft cone. Turn the tension nut until the rotor is able to be lifted from the motor shaft.

9 Loading the rotor

- With swing-out rotors all rotor positions must be lined with hangers.
- The rotors and hangers may only be loaded symmetrically. For authorised combinations see Chapter "Anhang/Appendix, Rotoren und Zubehör/Rotors and accessories".
- In containers with rubber inserts, the same number of rubber inserts must always be among the centrifuge containers.
- Always fill the centrifuge containers outside of the centrifuge.
- No liquid should be allowed to enter the centrifugal chamber during filling and swinging out of the hangers.
- In order to maintain the weight differences within the centrifuge container as marginal as possible, a consistent fill level in the containers is to be heeded.
- The weight of the permissible filling quantity is specified on each rotor. This weight may not be exceeded.

10 Making angle rotors aerosol-proof

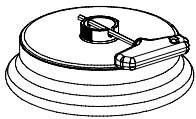

Fig. 5

To guarantee aerosol-proofness, the lids of aerosol-proof angle rotors must be screwed down using the spanner provided.

To screw down or loosen the lid, insert the provided spanner through the hole in the lid, see Fig. 5.

For available aerosol-proof angle rotors, please see chapter "Anhang/Appendix, Rotoren und Zubehör/Rotors and accessories".

11 Control and display elements

Please turn to the rear side of this cover sheet.

Fig. 2, Fig. 3: Display and control panel

11.1 Control panel symbols



Unbalance display. The unbalance display lights up if the permissible weight difference within the rotor loading has been exceeded.



Rotation display. The rotation display lights up during the centrifugation run as long as the rotor is turning.



Lid display. The lid display lights up if the lid is closed and locked. During the centrifugation run the lid display is extinguished.

Operating errors or any occurring disturbances are symbolised in the display (see Chapter "Faults").

11.2 Control panel pushbuttons (keys)



Selection control key for selection of specific parameter.
The subsequent parameter is selected by every further keystroke.



By pushing the arrow keys the value of a previously selected parameter is increased or decreased. By keeping an arrow key depressed the value is increased or decreased with increasing speed.



Start the centrifugation run. The rotation display  lights up.
Acquisition of input and changes.



Stop the centrifugation run.
The rotor runs down with pre-selected brake step. The LED in the key lights up until the rotor stops.
Pushing the key twice triggers the EMERGENCY STOP.



Selecting the RCF display.
The LED in the key lights up.



Short-term centrifugation.
The centrifugation run is effected as long as the key is held down.



Storing and recalling programmes.
The subsequent programme is displayed by every further keystroke (1 - 2 - 3 - #).

11.3 Adjustment possibilities

t/min	Adjustable from 1 - 99 min. in 1-min. intervals.
t/sec	Adjustable from 1 - 59 sec. in 1-sec. intervals.
∞	Continuous run.
RPM	Revolutions per minute. A numerical value from 500 RPM up to the maximum speed of the rotor can be set. Maximum speed of the rotor, see Chapter "Anhang/Appendix, Rotoren und Zubehör/Rotors and accessories". Adjustable from 500 RPM to 10000 RPM in steps of 10 and from 10000 RPM up to the maximum speed in steps of 100.
RAD/mm	Centrifugation radius. Input in mm. For centrifugation radius see Chapter "Anhang/Appendix, Rotoren und Zubehör/Rotors and accessories". The input of the radius is only possible if the RCF display is selected (LED in the key lights up).
RCF	Relative Centrifugal Acceleration. A numerical value can be set, which gives a speed between 500 RPM and the maximum speed of the rotor. Adjustable up to 100 in intervals of 1, and from 100 in intervals of 10. The RCF value is automatically rounded up or rounded down with regard to the RPM interval. The input of the RCF is only possible if the RCF display is selected (LED in the key lights up).
	Starting steps 1 - 9. Step 9 = shortest starting time, Step 1 = longest starting time.
	Brake steps 0 - 9. Step 9 = shortest run-down time, Step 1 = long run-down time, Step 0 = longest run-down time (brakeless run-down).
T/°C	Temperature Set Point (only in centrifuges with cooling). Adjustable from -20°C to +40°C, in 1°C intervals. The lowest obtainable temperature depends on the rotor (see Chapter "Anhang/Appendix, Rotoren und Zubehör/Rotors and accessories").
PROG	Programme Number. 3 programmes can be stored (programme positions 1 - 2 - 3). The programme position # serves as temporary storage for altered adjustments.

12 Entering centrifugation parameter



If no key is pressed for 8 seconds long after the selection or during the input of parameters, the previous values will be shown in the display. The input of parameter then has to be executed again.

- Select the RPM or RCF display with the key . If the RCF display is selected, the LED in the key lights up.
- Select the desired parameter with the key , and adjust with the keys .
- In order to adjust the symbol ∞ , the parameters **t/min** and **t/sec** must be set to zero with the key .
- After input of all parameters, press the key in order to store the adjustments on the programme position #. As confirmation, ***** ok ***** will be displayed for a short period.



The data on the programme position # will be overwritten with every input of parameters and pressing of the key .

13 Programming

13.1 Programme input/alteration

- Select the RPM or RCF display with the key . If the RCF display is selected, the LED in the key lights up.
- Select the desired parameter with the key , and adjust with the keys .
- Select the parameter **PROG** with the key , and set the desired programme position with the keys . The LED in the key lights up.
- Press the key in order to store the adjustments to the desired programme position. As confirmation, ***** ok ***** will be displayed for a short period.

13.2 Programme recall

- Select the desired programme position by pressing the key .
- The centrifugation data of the selected programme position will be displayed.
- The parameters can be checked by pressing the key .

14 Centrifugation



If the permissible weight difference within the rotor loading has been exceeded, the drive shuts down during the start-up, the unbalance display lights up, and **IMBALANCE** is displayed.

If the speed in the selected program is higher than the maximum speed of the rotor, it will not be possible to start a centrifugation run. **N > ROTOR MAX** will be displayed (see Chapter "Faults").

A centrifugation run can be stopped at any time by pushing the key **STOP**.

All parameters can be selected and altered during the centrifugation run (see Chapter "Entering centrifugation parameter").

You can switch-over at any time between the RPM and RCF display with the key **RCF**. The input of the centrifugation radius is necessary if you are working with the RCF display.

If **OPEN** or **OEFFNEN** is displayed, a further operation of the centrifuge is only possible after opening the lid once.

- Turn on the mains switch. Switch position I.
- Load the rotor and close the centrifuge lid.

14.1 Centrifugation with pre-set time

- Adjusting time or recall a programme with pre-set time (see Chapter "Entering centrifugation parameter" or "Programme recall").
- Press the key **START**. The rotation display  lights up as long as the rotor is turning.
- After expiration of the time or with truncation of the centrifugation run by pushing the key **STOP**, the run-down is effected with the selected brake step. The brake step is displayed.

During the centrifugation run the rotational speed of the rotor or the subsequently resulting RCF value, the sample temperature (only in centrifuges with cooling) and the remaining time will be displayed.

14.2 Continuous run

- Adjusting the symbol ∞ or recall a continuous run programme (see Chapter "Entering centrifugation parameter" or "Programme recall").
- Press the key **START**. The rotation display  lights up as long as the rotor is turning. The time metering begins at 00:00.
- Press the key **STOP** in order to stop the centrifugation run. The run-down is effected with the selected brake step. The brake step is displayed.

During the centrifugation run the rotational speed of the rotor or the subsequently resulting RCF value, the sample temperature (only in centrifuges with cooling) and the expired time will be displayed.

14.3 Short-term centrifugation

- Hold down the key **IMPULS**. The rotation display  lights up as long as the rotor is turning.
- Let go of the key **IMPULS** again in order to stop the centrifugation run. The run-down is effected with the selected brake step. The brake step is displayed.

During the centrifugation run the rotational speed of the rotor or the subsequently resulting RCF value, the sample temperature (only in centrifuges with cooling) and the expired time will be displayed.

15 Emergency Stop

- Press the key **STOP** twice.

With Emergency Stop the run-down is effected with brake step 9 (shortest run-down time). Brake step 9 is displayed. If brake step 0 was pre-selected, the run-down time is technically longer than with brake step 9.



16 Acoustic Signal

The acoustic signal sounds:

- Upon the appearance of a disturbance in 3 second intervals.
- After completion of a centrifugation run and rotor standstill in 30 second intervals.





The acoustic signal is stopped by opening the lid or pressing any key.

The signal can be activated or deactivated after completion of the centrifugation run (if the rotor is at standstill) in the following manner:

- Hold down the key  for 8 seconds.
After 8 seconds, **SOUND / BELL** appears in the display.
- Set **OFF** or **ON** with the key  or .
- Press the key **START** in order to store the setting.
As confirmation, ***** ok ***** will be displayed for a short period.

17 Recall hours of operation

Recall hours of operation is only possible during rotor standstill.

- Hold down the key  for 8 seconds.
After 8 seconds, **SOUND / BELL** appears in the display.
- Press the key  once again.
The centrifuge's hours of operation (**CONTROL:**) are displayed.
- Press the key  or  to exit the hours of operation recall.

18 Cooling (only in centrifuges with cooling)

The temperature set-point can be adjusted from -20°C to +40°C. The lowest obtainable temperature is dependent on the rotor (see Chapter "Anhang/Appendix, Rotoren und Zubehör/Rotors and accessories").

18.1 Standby-cooling

With rotor standstill and closed lid the centrifugal chamber is cooled to the pre-selected temperature. The temperature set-point is shown in the display.

18.2 Pre-cooling the rotor

For rapid pre-cooling of the unloaded rotor and the accessories, it is recommended that the centrifuge is run with the continuous running settings and a speed of ca. 20% of the maximum rotor speed.

19 Centrifugation of materials with higher density

The rotors are designed to centrifuge substances up to a maximum mean homogenous density of 1.2 kg/dm³ when rotating at the stated speed.

Denser substances must be centrifuged at lower speed.

The permissible speed can be calculated using the following formula:

$$\text{Reduced speed (n}_{\text{red}}) = \sqrt{\frac{1.2}{\text{Greater density}}} \times \text{Rated speed}$$

e.g.: RPM 4000, density 1.6 kg/dm³



$$n_{\text{red}} = \sqrt{\frac{1.2}{1.6}} \times 4000 = 3464 \text{ RPM}$$

If in doubt you should obtain clarification from the manufacturer.

20 Rotor Identification

After every start of a centrifugation run the rotor utilised is identified.

After the rotor has been changed, the drive switches off and the maximum speed and the rotor code are displayed briefly.

Afterwards,  OPEN  OEFFNEN is displayed and further operation of the centrifuge is only possible after opening the lid once.

If, following a rotor change, the maximum speed of the rotor is less than the set speed, the speed is limited to the maximum speed of the rotor.

21 Emergency release

The lid cannot be opened during power failure. An emergency release has to be executed by hand.



For emergency release disconnect the centrifuge from the network.
Open the lid only during rotor standstill.

Please turn to the rear side of the cover sheet.

- Insert the release pin (see scope of supply) horizontally into the hole (Fig. 1, A). Push the release pin in until, when the pin is pushed up, the handle can be swung up.
- Open the lid.

22 Maintenance and servicing



Pull the mains plug before cleaning.

Before any other cleaning or decontamination process other than that recommended by the manufacturer is applied, the user has to check with the manufacturer that the planned process does not damage the device.

- Cleaning agents and disinfectants which lie in the pH range 6 – 8 are to be utilised. Alkaline cleaning agents with a pH value > 8 are to be avoided.
- In order to prevent appearances of corrosion through cleaning agents or disinfectants, the application guide from the manufacturer of the cleaning agent or disinfectant are absolutely to be heeded.

22.1 Centrifuge

- Regularly clean the centrifuge housing and the centrifugal chamber; and if necessary, clean with soap or a mild cleaning agent and water. For one thing, this services purposes of hygiene, and it also prevents corrosion through adhering impurities.
- In the event of condensation water formation, dry the centrifugal chamber by wiping out with an absorbent cloth.
- If infectious materials penetrates into the centrifugal chamber this is to be disinfected immediately.
- Lightly grease the rubber seal of the centrifugal chamber after every cleaning.

22.2 Rotors and Attachments

- Rotors and accessory parts must be regularly cleaned with soap or a mild cleaning agent and water in order to prevent corrosion and changes of material. Cleaning is recommended at least once a week, even better after every usage.
- If the rotor or accessory parts are contaminated by pathogenic or radioactive material, a suitable cleaning has to be executed.
- The rotors and accessory parts must be dried immediately after cleaning.
- Angle rotors, containers and hangers made of aluminium are to be lightly greased after drying (Hettich Lubricating Grease Order No. 4051).
- With aerosol-sealed rotors and bio safety systems (see Chapter "Anhang/Appendix, Rotoren und Zubehör/Rotors and accessories") the sealing rings are to be checked and cleaned regularly (weekly). The sealing ring is to be replaced immediately upon indication of crack formation, embrittlement or abrasive wear.
- In order to prevent corrosion as a result of moisture between the rotor and the motor shaft, the rotor should be disassembled and cleaned at least once a month, and the motor shaft should be lightly greased.
- The rotors and accessory parts are to be checked on a monthly basis for corrosion damage.



Rotors and attachments may no longer be utilised upon indication of wear and tear or corrosion.

22.2.1 Supporting lugs

With swing-out rotors the supporting lugs must be regularly lubricated (Hettich Lubricating Grease No. 4051) in order to ensure consistent swinging out of the hangers.

22.3 Autoclaving

Swing-out rotors, angle rotors made of aluminium and accessory parts can be autoclaved at 121°C (20 min).



The lids of the rotors and containers must be removed before autoclaving.

Autoclaving accelerates the ageing process of plastics. In addition, it can cause colour alterations in plastics.

22.4 Broken glass

- In the event of broken glass the glass splinters and leaking centrifugal material are to be carefully removed from the centrifugal chamber and from the containers or container drillings.
- Replace the rubber inserts.



The rubber inserts of the container must be replaced after breakage of glass, because any remaining glass splinters in the rubber cores could cause further breakage of glass.

- If this concerns infectious material, a disinfection process is to be executed immediately.

23 Faults

If the error is not able to be eliminated according to the fault chart, and if the error message appears once again in the display after MAINS-RESET, the Hettich Customer Service Department is to be notified.

Please state the type of centrifuge and the factory serial number. Both values are visible on the centrifuge type plate.

MAINS RESET: - Mains switch OFF for longer than 10 secs.
- Mains switch ON.

Message / fault		Cause	Remedy
No display	---	- No voltage. - Overvoltage protection tripped out.	- Check supply voltage. - Mains switch ON.
TACHO - ERROR	01	- Faulty speedometer.	- Open lid.
	02	- No rotor installed. - Defective motor, frequency converter or drive.	- Turn rotor manually. - MAINS-RESET when power is switched on, rotor should turn.
IMBALANCE	---	Imbalance about motor axis through weight differential in rotor assembly.	- Open lid. - Correct imbalance.
CONTROL - ERROR	04, 06 - 09	Error in lid locking or lid closure.	- Open lid. - MAINS-RESET
N > MAX	05	Rotation too fast	
N < MIN	13	Rotation too slow	
ROTORCODE	10	Incorrect rotor coding	
MAINS INTERRUPT	---	Power failure, centrifuging not properly completed	- Open lid. - Push START button.
VERSIONS-ERROR	12	Mismatch between electronic components	- Open lid. - MAINS-RESET
CONTROL-ERROR	21 - 27	Error / defective control unit	
SER I/O - ERROR	30 - 38	Error / defective interface	
° C * - ERROR	50 - 56	Error / defective cooling	
LOCK - ERROR	57	Error / defective program locking	
FU / CCI - ERROR	60 - 83	Error / defective motor control	
N > ROTOR-MAX	---	Speed in the selected program greater than the maximum speed of the rotor.	- Check the set speed. Reduce the set speed

24 Acceptance of the centrifuges for repair

If the centrifuge is returned to the manufacturer for repair, it must be decontaminated and cleaned to protect persons, environment and material.

We reserve the right to accept contaminated centrifuges.

Costs incurred for cleaning and disinfection are to be charged to the customer.

We ask for your understanding in this matter.

You will find further information on our homepage: <http://www.HettichLab.com>

Table des matières

1	Utilisation	20
2	Consignes de sécurité	20
3	Symboles utilisés	21
4	Composition de la livraison	21
5	Déballer la centrifugeuse	21
6	Mise en service	21
7	Ouvrir et fermer le couvercle	21
7.1	Ouvrir le couvercle	21
7.2	Fermer le couvercle	22
8	Montage et démontage du rotor	22
9	Chargement du rotor	22
10	Fermer le rotor à orientation libre de manière étanche aux aérosols	22
11	Organes de commande et indicateurs	22
11.1	Icônes de la console de commande	22
11.2	Touches de la console de commande	22
11.3	Possibilités de réglage	23
12	Saisie des paramètres de centrifugation	23
13	Programmation	23
13.1	Saisie / Modification de programme	23
13.2	Appel de programme	24
14	Centrifugation	24
14.1	Centrifugation avec sélection de temps préalable	24
14.2	Centrifugation continue	24
14.3	Centrifugation rapide	24
15	Arrêt d'urgence	24
16	Signal sonore	25
17	Interrogation du compteur de durée de fonctionnement	25
18	Refroidissement (uniquement sur centrifugeuse avec refroidissement)	25
18.1	Refroidissement en veilleuse	25
18.2	Pré-refroidissement du rotor	25
19	Centrifugation de substances à haute densité	25
20	Identification de rotor	25
21	Déverrouillage d'urgence	25
22	Entretien et maintenance	26
22.1	Centrifugeuse	26
22.2	Rotors et accessoires	26
22.2.1	Goupilles de fixation	26
22.3	Autoclavage	26
22.4	Bris de verre	26
23	Défauts	27
24	Réparation des centrifugeuses	27
25	Anhang / Appendix	37
25.1	Technische Daten / Technical specification	37
25.2	Rotoren und Zubehör / Rotors and accessories	38

1 Utilisation

La centrifugeuse est utilisée pour la centrifugation de matières ou de mélanges d'une densité maximale de 1,2 kg/dm³.

2 Consignes de sécurité



- La centrifugeuse a été construite conformément à l'état actuel de la technique et son fonctionnement est sûr.
 - Elle peut cependant présenter des dangers pour l'utilisateur ou des tiers si son utilisation n'est pas confiée à un personnel dûment formé, est inadéquate ou non conforme à sa destination.
- Il importe de lire et de respecter le mode d'emploi avant la mise en service de la centrifugeuse.
- Outre le mode d'emploi et les réglementations contraignantes relatives à la prévention des accidents, il importe également de respecter les règles spécifiques et communément admises en matière de sécurité et de travail. Le mode d'emploi doit être complété des dispositions nationales applicables à la prévention des accidents et à la protection de l'environnement.
- Veiller à la stabilité de la centrifugeuse.
- Pendant le fonctionnement, la centrifugeuse ne devra pas être déplacée ou être heurtée.
- Afin d'éviter des endommagements par du condensat, la centrifugeuse devra, lors du passage d'un local froid dans un local chaud, tourner pour s'échauffer 30 minutes dans le local froid ou se réchauffer, avant de pouvoir la connecter au secteur, au moins pendant 3 heures dans le local chaud.
- Les récipients de centrifugation ne peuvent être remplis qu'à la capacité indiquée par le fabricant.
 - Les récipients de centrifugation doivent être remplis à l'extérieur de la centrifugeuse.
- Des récipients standard de centrifugation en verre sont résistants jusqu'à un ACR de 4000 (DIN 58970, partie_2).
- Les récipients (tubes, bouteilles) ne doivent être centrifugés qu'avec des accessoires (réducteurs, nacelles, portoirs, etc.) autorisés par le constructeur (voir chapitre "Anhang/Appendix, Rotoren und Zubehör/Rotors and accessories").
- Dans le cas de la centrifugation à la vitesse maximale, la densité des substances et des mélanges de substances ne doit pas excéder 1,2 kg/dm³.
- Il est interdit de procéder à des centrifugations en présence de défauts d'équilibrage.
- Il est interdit d'utiliser la centrifugeuse dans des locaux présentant des risques d'explosion.
- Il est interdit de procéder à des centrifugations :
 - avec des matières inflammables ou explosives,
 - avec des matières susceptibles de réagir chimiquement ou de dégager d'importantes quantités d'énergie.
- En cas de centrifugation de substances dangereuses ou de substances mixtes toxiques, radioactives ou contaminées par des micro-organismes pathogènes, il incombe à l'utilisateur de prendre les mesures ad hoc. Sans dispositif additionnel (tel qu'un joint d'étanchéité entre béccher et couvercle ou un joint spécial entre rotor angulaire et son couvercle) une centrifugeuse n'est pas un dispositif de sécurité biologique selon la norme EN 61010-2-20.

Pour ce qui concerne les matières classées dans le groupe à risques II (voir le manuel "Laboratory Biosafety Manual" publié par l'Organisation Mondiale de la Santé), il est nécessaire de mettre en oeuvre un système de sécurité biologique. Dans un tel système, un joint biologique (bague d'étanchéité) placé entre les supports et le capot empêchera la fuite de gouttelettes et d'aérosols. Pour la centrifugation, il est également possible de se procurer dans le commerce des récipients de centrifugation dotés de fermetures à visser spéciales et destinés au traitement de substances dangereuses.

Pour le traitement de matières classées dans des groupes à risques supérieurs, il est nécessaire de mettre en oeuvre des mesures de sécurité complémentaires, en d'autres termes, des récipients de centrifugation dotés d'une fermeture à visser spéciale doivent être centrifugés dans un système à sécurité biologique.
- Pour ce qui concerne les systèmes à sécurité biologique, voir le chapitre "Anhang/Appendix, Rotoren und Zubehör/Rotors and accessories". Dans le doute vous pouvez obtenir les informations auprès du fabricant.
- Il est interdit de centrifuger des matières fortement corrosives pouvant réduire la résistance mécanique des rotors, des supports et des accessoires.
- Les rotors, supports et accessoires présentant d'importantes traces de corrosion ou des dommages mécaniques ne peuvent pas être utilisés pour la centrifugation.
- Les réparations ne peuvent être effectuées que par une personne autorisée à cet effet par le fabricant.
- Utiliser uniquement les pièces de rechange originales et les accessoires d'origine homologués par les Etablissements Hettich.
- En cas de défaillance ou en cas de déverrouillage d'urgence, ne jamais intervenir dans l'appareil lorsque le rotor tourne.
- La centrifugeuse est un appareil du Groupe 3 mentionné dans le décret allemand relatif aux appareils médicaux (MedGV).
- Les consignes de sécurité sont conformes aux normes :
 - IEC 1010-1/-2
 - DIN - EN61010 Partie 1,2
- La sécurité et la fiabilité de la centrifugeuse seront uniquement garanties si :
 - la centrifugeuse est utilisée conformément aux instructions du mode d'emploi,
 - l'installation électrique du site de la centrifugeuse est conforme aux prescriptions IEC,

- les contrôles prescrits selon UVV-VBG7z sont effectués par un personnel spécialisé averti.
- Pour les centrifugeuses robotisées veuillez absolument considérer les indications pour l'interrupteur à clé.

Le non respect des présentes consignes exclut tout recours à la garantie.

3 Symboles utilisés



Attention, suivre les consignes du mode d'emploi !



Charger le rotor de la centrifugeuse de manière uniforme.
Tous les emplacements du rotor doivent être occupés.



Ne pas remplir les pots de centrifugation dans la centrifugeuse.

4 Composition de la livraison

- 1 Câble de connexion
- 1 Clé mâle coudée
- 1 Tige de déverrouillage
- 1 Graisse pour tourillon porteur
- 1 Mode d'emploi
- 1 Fiche de consignes pour le transport

Le(s) rotor(s) et accessoires correspondant sont livrés selon les spécifications de la commande.

5 Déballer la centrifugeuse

- Soulever le carton et retirer le matériau d'amortissement.
- Avec un nombre suffisant d'aides, soulever la centrifugeuse sur les deux faces et la déposer sur la table de laboratoire.



Ne pas saisir sur le tableau de commande frontal pour soulever.

6 Mise en service

- Aux termes de la norme EN sur les laboratoires EN 61010-2-20, l'installation locale doit être équipée d'un interrupteur d'arrêt d'urgence pour sectionner l'alimentation du secteur en cas de défaut. Cet interrupteur doit être éloigné de la centrifugeuse, de préférence hors de la pièce dans laquelle est la centrifugeuse ou près de la porte.
- Placer la centrifugeuse sur un emplacement approprié de manière à ce qu'elle soit stable et mettre de niveau. Veiller à préserver une zone de sécurité de 300 mm autour de la centrifugeuse, conformément à la norme IEC 1010-2-2.



Personne ni aucune substance dangereuse ne doit se trouver dans l'enceinte de sécurité de la centrifugeuse pendant le fonctionnement.

- Ne pas placer d'objet devant la grille de ventilation.
Ménager un espace de ventilation de 300 mm autour de la grille.
- Vérifier que la tension de secteur est identique à la mention de la plaque signalétique.
- Raccorder la centrifugeuse à une prise de secteur normalisée au moyen du câble de connexion.
- Activer l'interrupteur de secteur. Amener l'interrupteur en position "I".
L'afficheur donne le type de la machine et la version de programme ; après 8 s, les informations sur la dernière utilisation de la centrifugeuse sont affichées.
- Ouvrir le capot.
- Enlever la sécurité de transport (voir la fiche de consignes "Sécurité de transport").

7 Ouvrir et fermer le couvercle

7.1 Ouvrir le couvercle

- Faire pivoter la baguette de la poignée du couvercle vers le haut. La DEL  s'éteint.
- Ouvrir le capot.



Le capot ne peut être ouvert que lorsque la centrifugeuse est sous tension et que le rotor est à l'arrêt. Dans les autres cas, voir le chapitre, "Déverrouillage d'urgence".

7.2 Fermer le couvercle

- Poser le couvercle dessus et faire pivoter la baguette de la poignée du couvercle vers le bas. La DEL  s'allume.



Ne pas laisser tomber le couvercle pour le fermer.

8 Montage et démontage du rotor

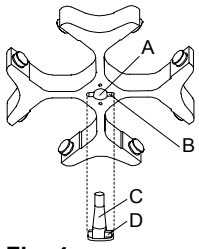

Fig. 4

- Nettoyer l'arbre d'entraînement (C) et l'alésage du rotor (A) et enduire ensuite l'arbre d'entraînement d'une pellicule de graisse. Les particules d'impuretés entre l'arbre d'entraînement et le rotor réduisent la stabilité d'assise du rotor et provoquent un fonctionnement irrégulier.
- Enfiler le rotor à la verticale sur l'arbre d'entraînement. Le taquet de l'arbre d'entraînement (D) doit être logé dans la rainure du rotor (B). L'orientation de la rainure est indiquée sur le rotor.
- Serrer l'écrou de fixation du rotor avec la clé de la livraison en tournant dans le sens horloger.
- Vérifier la stabilité d'assise du rotor.
- Démontage du rotor : Desserrer l'écrou de fixation par rotation dans le sens anti-horloger jusqu'à ce que le rotor puisse être détaché par pression. En exerçant une légère pression, détacher le rotor du cône de l'arbre d'entraînement. Dévisser l'écrou de fixation jusqu'à ce que le rotor soit détaché de l'arbre d'entraînement.

9 Chargement du rotor

- Toutes les positions de rotor doivent être équipées de balanciers dans le cas des rotors à balanciers.
- Le chargement des rotors et des balanciers doit être nécessairement symétrique. Pour les combinaisons possibles, voir le Chapitre "Anhang/Appendix, Rotoren und Zubehör/Rotors and accessories".
- Dans le cas des récipients à garniture de caoutchouc, les récipients de centrifugation doivent avoir le même nombre de garnitures dans la partie inférieure.
- Les récipients de centrifugation doivent toujours être remplis hors de la centrifugeuse.
- Aucun liquide ne doit parvenir dans le bol de centrifugeuse pendant le remplissage et le déplacement des balanciers.
- La hauteur de remplissage des récipients sera autant que possible égale pour maintenir les différences de poids entre les récipients de centrifugation aussi réduites que possible.
- Le poids du volume de remplissage autorisé est indiqué sur chaque rotor. Il est interdit de dépasser cette tare.

10 Fermer le rotor à orientation libre de manière étanche aux aérosols

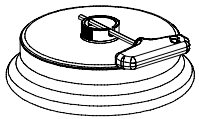

Fig. 5

Afin de garantir une étanchéité aux aérosols, les couvercles de rotors à orientation libre étanches aux aérosols doivent être bloqués à l'aide la clé jointe à la livraison.

Pour bloquer ou desserrer le couvercle, introduire la clé jointe dans le forage du couvercle, voir Fig.5.

Rotors à orientation libre disponibles, voir chapitre "Anhang/Appendix, Rotoren und Zubehör/Rotors and accessories".

11 Organes de commande et indicateurs

Ouvrir la partie arrière de la plaque de recouvrement.

Fig. 1, Fig. 2: Console des indicateurs et organes de commande

11.1 Icônes de la console de commande



Indicateur de déséquilibre. L'indicateur de déséquilibre s'allume lorsque la différence de poids autorisée est dépassée pour le chargement du rotor.



Indicateur de rotation. L'indicateur de rotation s'allume pendant la centrifugation et reste allumé tant que le rotor tourne.



Indicateur de couvercle. L'indicateur de couvercle s'allume lorsque le couvercle est fermé et verrouillé. L'indicateur de couvercle s'éteint pendant la centrifugation.

Les erreurs de commande et les défauts sont signalés par des icônes sur l'afficheur (voir le Chapitre "Défauts").

11.2 Touches de la console de commande



Touche de sélection des différents paramètres.
Les paramètres sont sélectionnés l'un après l'autre en appuyant sur la touche.





Incrémenter/Décroître la valeur du paramètre sélectionné précédemment en appuyant sur les touches fléchées. Le maintien de l'action sur la touche fléchée entraîne la modification rapide des valeurs.







Démarrer la centrifugation. L'indicateur de rotation  s'allume.
Transfert des entrées et modifications.



Stopper la centrifugation.
Le rotor est décéléré à la vitesse de freinage sélectionnée. La diode lumineuse incorporée dans la touche reste allumée jusqu'à ce que le rotor soit immobilisé. L'ARRET D'URGENCE est activé en appuyant deux fois sur la touche.







-  Sélection de l'indicateur RCF.
La diode lumineuse incorporée dans la touche s'allume.
-  Centrifugation rapide.
La centrifugation est exécutée tant que l'action est maintenue sur la touche.
-  Sauvegarde et appel de programmes.
Les programmes sont sélectionnés dans l'ordre l'un après l'autre en appuyant sur la touche (1 - 2 - 3 - #).



11.3 Possibilités de réglage

- t/min Réglage de 1 à 99 min, par incréments de 1 min.
- t/sec Réglage de 1 à 59 s, par incréments de 1 seconde.
- ∞ Fonctionnement continu.
- RPM Vitesse. Il est possible de régler une valeur numérique comprise entre 500 RPM et la vitesse de rotation maximale du rotor. Pour la vitesse maximale de rotation du rotor, se reporter au chapitre "Anhang/Appendix, Rotoren und Zubehör/Rotors and accessories". Paramétrable de 500 RPM à 10000 RPM par intervalles de 10 et à partir de 10000 RPM jusqu'à la vitesse maximale de rotation, par intervalles de 100.
- RAD/mm Rayon de centrifugation. Valeurs en mm. Pour la saisie de rayon de centrifugation, voir le Chapitre "Anhang/Appendix, Rotoren und Zubehör/Rotors and accessories". La saisie du rayon n'est possible que lorsque l'indicateur RCF a été sélectionné (la diode incorporée dans la touche  s'allume).
- RCF Accélération relative de centrifugation. Il est possible de régler une valeur numérique dont découle une vitesse de rotation située entre 500 RPM et la vitesse maximale de rotation du rotor. Réglage par incréments de 1 jusqu'à 100, par incréments de 10 à partir de 100. La valeur RCF est arrondie automatiquement au chiffre supérieur/inférieur en fonction de l'incrément de vitesse. La saisie de RCF n'est possible que lorsque l'indicateur RCF est sélectionné (la diode incorporée dans la touche  s'allume).
-  Etages de montée en puissance de 1 à 9. Etage 9 = temps de montée en puissance le plus court, étage 1 = temps de montée en puissance le plus long.
-  Etages de décélération de 0 à 9. Etage 9 = temps de décélération le plus court, étage 1 = étage de décélération long, étage 0 = étage de décélération le plus long (décélération par inertie, sans freinage).
- T/°C Valeur de température de consigne (uniquement sur centrifugeuse avec refroidissement). Réglage de -20 °C à +40 °C, par incréments de 1 °C. La température la plus basse pouvant être établie est fonction du rotor (voir le Chapitre "Anhang/Appendix, Rotoren und Zubehör/Rotors and accessories").
- PROG Numéro de programme. Il est possible de sauvegarder 3 programmes (positions de programme 1 - 2 - 3). La position de programme # sert de mémoire temporaire pour la modification des réglages.

12 Saisie des paramètres de centrifugation











 Après sélection de paramètres et pendant la sélection des paramètres, l'indicateur bascule sur les valeurs précédentes si aucune action n'exécute sur les touches pendant 8 secondes. Il est alors nécessaire de recommencer la saisie des paramètres.

- Sélectionner l'indicateur RPM ou RCF en appuyant sur la touche  La diode incorporée dans la touche  s'allume après sélection de l'indicateur RCF.
 - Sélectionner les paramètres souhaités en appuyant sur la touche  et ajuster en appuyant sur les touches  
- Pour ajuster sur l'icône ∞, les paramètres **t/min** et **t/sec** doivent être forcés sur zéro en appuyant sur la touche 
- Après entrée de tous les paramètres, appuyer sur la touche  pour sauvegarder les réglages sur la position de programme #. La saisie est confirmée par affichage de ***** ok ***** pendant un instant.

 Les données de la position de programme # sont écrasées par entrée de paramètres et en appuyant sur la touche .

13 Programmation

13.1 Saisie / Modification de programme

- Sélectionner l'indicateur RPM ou RCF en appuyant sur la touche . La diode incorporée dans la touche  s'allume après sélection de RCF.
- Sélectionner les paramètres souhaités en appuyant sur la touche  et ajuster en appuyant sur les touches  
- Sélectionner le paramètre **PROG** en appuyant sur la touche  et régler la position de programme souhaitée en appuyant sur les touches   La diode incorporée dans la touche  s'allume.
- Appuyer sur la touche  pour sauvegarder les réglages sur la position de programme souhaitée. La saisie est confirmée par affichage de ***** ok ***** pendant un instant.

13.2 Appel de programme

- Sélectionner la position de programme souhaitée en appuyant sur la touche **PROG**. Les informations de centrifugation de la position de programme sélectionné sont affichées.
- Vérifier les paramètres en appuyant sur la touche **←**.

14 Centrifugation



L'entraînement est stoppé en phase de montée en puissance si la différence de tare admissible a été dépassée pendant le chargement du rotor, l'indicateur de déséquilibre s'allume et la mention **IMBALANCE** est affichée.

Si la vitesse de rotation du programme sélectionné est supérieure à la vitesse de rotation maximale du rotor, aucun processus de centrifugation ne peut être lancé. La mention **N > ROTOR MAX** est affichée (voir le Chapitre "Défauts").

La centrifugation peut être stoppée n'importe quand en appuyant sur la touche **STOP**.

Il est possible de sélectionner et de modifier tous les paramètres pendant la centrifugation (voir le Chapitre "Saisie des paramètres de centrifugation").

Il est possible de basculer n'importe quand sur l'indicateur RPM et RCF en appuyant sur la touche **RCF**. Pour travailler avec l'indicateur RCF, il est nécessaire d'entrer le brayon de centrifugation.

Après affichage de **OPEN** / **OEFFNEN** (= OUVRIR) la commande de centrifugeuse n'est possible qu'après avoir ouvert le couvercle une fois.

- Mettre la centrifugeuse sous tension. Amener l'interrupteur en position I.
- Charger le rotor et fermer le couvercle de centrifugeuse.

14.1 Centrifugation avec sélection de temps préalable

- Régler le temps et appeler un programme avec sélection de temps préalable (voir le Chapitre "Saisie des paramètres de centrifugation" ou "Appel de programme").
- Appuyer sur la touche **START**. L'indicateur de rotation  reste allumé pendant toute la durée de fonctionnement du rotor.
- La décélération selon l'étage de freinage sélectionné est exécutée après écoulement du temps ou interruption de la centrifugation en appuyant sur la touche **STOP**. L'étage de freinage est affiché.

Pendant la centrifugation, l'afficheur donne la vitesse du rotor ou la valeur RCF résultants, la température des échantillons (uniquement sur centrifugeuse avec refroidissement) et la durée restante.

14.2 Centrifugation continue

- Ajuster sur l'icône ∞ ou appeler un programme de centrifugation continue (voir le Chapitre "Saisie des paramètres de centrifugation" ou "Appel de programme").
- Appuyer sur la touche **START**. L'indicateur de rotation  reste allumé pendant toute la durée de fonctionnement du rotor. Le compte du temps commence à 00:00.
- Pour stopper la centrifugation, appuyer sur la touche **STOP**. La décélération est exécutée selon l'étage de freinage sélectionné. L'étage de freinage est affiché.

Pendant la centrifugation, l'afficheur donne la vitesse du rotor ou la valeur RCF résultants, la température des échantillons (uniquement sur centrifugeuse avec refroidissement) et la durée restante.

14.3 Centrifugation rapide

- Appuyer sur la touche **IMPULS** et maintenir l'action. L'indicateur de rotation  reste allumé pendant toute la durée de fonctionnement du rotor.
- Pour stopper la centrifugation rapide, cesser l'action sur la touche **IMPULS**. La décélération est exécutée selon l'étage de freinage sélectionné. L'étage de freinage est affiché.

Pendant la centrifugation, l'afficheur donne la vitesse du rotor ou la valeur RCF résultants, la température des échantillons (uniquement sur centrifugeuse avec refroidissement) et la durée restante.

15 Arrêt d'urgence

- Appuyer 2 fois sur la touche **STOP**

La décélération est exécutée sur l'étage 9 (temps de décélération le plus court) en cas d'arrêt d'urgence L'étage de freinage 9 est affiché.

Si l'étage de freinage 0 a été sélectionné, la décélération est plus longue, pour des raisons technique, que pour l'étage de freinage 9.



16 Signal sonore

Le signal sonore retentit :

- en présence d'un défaut à un intervalle de 3 s.
- au terme de la centrifugation et après immobilisation du rotor, à un intervalle de 30 s.





Le signal sonore cesse après ouverture du couvercle, en appuyant sur une touche quelconque.

Pour activer / désactiver le signal sonore après la centrifugation, alors que le rotor est immobilisé, procéder comme suit :

- Appuyer sur la touche  pendant 8 s.
Après 8 s, la mention **SOUND / BELL** est affichée.
- En appuyant sur la touche  ou  **OFF** (arrêt) ou **ON** (marche) selon le réglage de votre choix.
- Appuyer sur la touche **START** pour sauvegarder le réglage.
La saisie est confirmée par affichage de ***** ok ***** pendant un instant.

17 Interrogation du compteur de durée de fonctionnement

Il n'est possible d'interroger le compteur de durée de fonctionnement qu'à l'arrêt du rotor.

- Appuyer sur la touche  pendant 8 s.
Après 8 s, la mention **SOUND / BELL** est affichée.
- Appuyer une nouvelle fois sur la touche .
La durée de fonctionnement (**CONTROL:**) de la centrifugeuse est affichée.
- Pour quitter l'interrogation du compteur de durée de fonctionnement, appuyer sur la touche  ou .

18 Refroidissement (uniquement sur centrifugeuse avec refroidissement)

La température de consigne peut être réglée sur une plage de -20 °C à +40 °C. Le minimum de température possible est fonction du rotor (voir le Chapitre "Anhang/Appendix, Rotoren und Zubehör/Rotors and accessories").

18.1 Refroidissement en veilleuse

A l'arrêt du rotor et lorsque le couvercle est fermé, le bol de centrifugeuse est refroidi à la température sélectionnée. La température de consigne est indiquée sur l'afficheur.

18.2 Pré-refroidissement du rotor

Afin de garantir une prérefrigération rapide du rotor à l'état non chargé et des accessoires utilisés, il est recommandé de sélectionner un processus de centrifugation avec les paramétrages du fonctionnement en continu et une vitesse de rotation d'environ 20% de la vitesse de rotation maximale du rotor.

19 Centrifugation de substances à haute densité

Les rotors sont conçus pour centrifuger à vitesse de rotation nominale des matières à densité homogène moyenne maximale de 1,2 kg/dm³. Les matières à densités plus élevées doivent être centrifugées à vitesse plus lente.

La vitesse de rotation autorisée se calcule de la manière suivante:

$$\text{Vitesse de centrifugation lente (n}_{\text{red}}) = \sqrt{\frac{1,2}{\text{densité supérieure}}} \times \text{Vitesse de rotation nominale}$$

Exemple: RPM 4000, densité 1,6 kg/dm³

$$n_{\text{red}} = \sqrt{\frac{1,2}{1,6}} \times 4000 = 3464 \text{ RPM}$$

En cas d'incertitude, prendre contact avec le fabricant.

20 Identification de rotor

Après démarrage de chaque cycle de centrifugation, la machine exécute une routine d'identification du rotor utilisé.

Suite à un changement de rotor, le système d'entraînement est désactivé et le programme affiche brièvement la vitesse de rotation maximale, ainsi que le code du rotor.

L'afficheur visualise ensuite les mentions  OPEN  OEFFNEN (= OUVRIER); il n'est alors possible d'utiliser la centrifugeuse qu'après avoir ouvert le couvercle.

Suite à un changement de rotor, si la vitesse maximale de rotation du rotor est inférieure à la vitesse de rotation paramétrée, la vitesse de rotation est limitée à la vitesse maximale de rotation du rotor.

21 Déverrouillage d'urgence

En cas de panne de courant, le couvercle ne peut pas être ouvert. Il est nécessaire d'exécuter un déverrouillage manuel.



Avant d'exécuter le déverrouillage manuel, retirer la fiche de l'alimentation.
Attendre que le rotor est à l'arrêt pour ouvrir le couvercle.

Ouvrir la partie arrière de la plaque de recouvrement.

- Introduire la goupille de déverrouillage horizontalement (voir étendue de la livraison) dans le forage (Fig. 1, A). Introduire la goupille de déverrouillage aussi loin jusqu'à ce qu'en appuyant vers le haut, la barre de maniement se laisse pivoter vers le haut.
- Ouvrir le capot.

22 Entretien et maintenance



Retirer la prise de secteur avant de nettoyer.

Avant d'utiliser une procédure de nettoyage ou de décontamination autre que celle recommandée par le fabricant, l'utilisateur vérifiera auprès du fabricant que la procédure prévue n'endommage pas l'appareil.

- Utiliser des agents de nettoyage et de désinfection de pH entre 6 et 8. Ne pas utiliser les agents de nettoyage alcalins d'un pH > 8.
- Respecter impérativement les consignes spéciales d'utilisation données par le fabricant des agents de nettoyage et de désinfection, afin de prévenir la corrosion par les agents de nettoyage et de désinfection.

22.1 Centrifugeuse

- Nettoyer régulièrement le carter de la centrifugeuse et le bol de la centrifugeuse ; si nécessaire, utiliser le savon ou un agents de nettoyage doux. Ces opérations sont nécessaires pour garantir l'hygiène et pour prévenir la corrosion par la présence durable d'impuretés.
- Sécher le bol avec un chiffon absorbant en cas de dépôt d'eau de condensation dans le bol de la centrifugeuse.
- Le bol de la centrifugeuse doit être nettoyé immédiatement dans le cas où un matériau infectieux a pénétré dans le bol de la centrifugeuse.
- Enduire d'un film de graisse le joint en caoutchouc du bol de centrifugeuse au terme de chaque nettoyage.

22.2 Rotors et accessoires

- Les rotors et les accessoires doivent être nettoyés régulièrement au savon ou avec un agent de nettoyage doux et à l'eau pour prévenir la corrosion et la déformation des matériaux. Exécuter le nettoyage au moins une fois par semaine, l'idéal étant de nettoyer après chaque utilisation.
- Un nettoyage approprié sera exécuté dans le cas où le rotor et les accessoires ont été contaminés par un matériau pathogène ou radioactif.
- Sécher les rotors et les accessoires immédiatement après le nettoyage.
- Enduire d'une pellicule de graisse les rotors inclinés, les récipients et la suspension en aluminium après séchage (graisse de lubrification Hettich, n° de référence 4051).
- Vérifier régulièrement les bagues d'étanchéité (une fois par semaine) sur les rotors étanches aux aérosols et les systèmes de sécurité biologiques (voir le chapitre "Anhang/Appendix, Rotoren und Zubehör/Rotors and accessories"). Changer immédiatement la bague d'étanchéité si elle présente des marques de fissuration, de friabilité et d'usure.
- Déposer le rotor au moins une fois par mois, nettoyer et enduire l'arbre d'entraînement d'une pellicule de graisse pour prévenir la corrosion par la présence d'humidité entre le rotor et l'arbre d'entraînement.
- Vérifier une fois par mois que les rotors et les accessoires ne sont pas endommagés par la corrosion.



Les rotors et les accessoires usés et endommagés par la corrosion ne doivent plus être utilisés.

22.2.1 Goupilles de fixation

Les goupilles de fixation des rotors à amortissement doivent être graissées régulièrement (graisse de lubrification Hettich n° 4051) de manière à assurer le balancement régulier de la suspension.

22.3 Autoclavage

Les rotors à balancier, les rotors inclinés en aluminium et les accessoires peuvent être autoclavés à 121 °C (20 min).



Avant l'autoclavage, déposer le couvercle des rotors et du récipient.

L'autoclavage provoque l'accélération du vieillissement des plastiques et peut provoquer des décolorations des plastiques.

22.4 Bris de verre

- En cas de bris de verre, retirer soigneusement les débris de verre et la matière centrifugée qui s'est échappée du bol de centrifugeuse, des récipients et les alésages de récipient .
- Changer les garnitures de caoutchouc.



Il est nécessaire de changer les garnitures de caoutchouc des récipients après bris de verre car les morceaux de verre restant provoquent de nouvelles casses.

- S'il s'agit d'un matériau infectieux, exécuter immédiatement une désinfection.

23 Défauts

Prévenir le service après-vente Hettich s'il est impossible d'éliminer le défaut au moyen du tableau des défauts et si le message de défaut est toujours affiché après REINITIALISATION RESEAU.

Vous aurez l'obligeance de mentionner le modèle de centrifugeuse et le numéro d'usine. Les deux sont marqués sur la plaque signalétique de la centrifugeuse.

REINITIALISATION RESEAU: - Commutateur principal ARRÊT, > 10s.
- Commutateur principal MARCHE.

Message / Erreur		Origine	Solution
Pas de message	---	- Pas de tension - Déclenchement du fusible protecteur contre surintensité	- Contrôler la tension d'alimentation - Secteur en marche
TACHO - ERROR	01	- Tachymètre défectueux.	- Ouvrir le capot.
	02	- Absence de rotor. - Moteur, convertisseur, entraînement défectueux.	- Tourner le rotor manuellement. - REINITIALISER RESEAU, le rotor doit tourner lors de la mise sous tension.
IMBALANCE	---	Défaut d'équilibrage à l'arbre-moteur en raison de différences de poids dans l'équipement du rotor.	- Ouvrir le capot. - Corriger l'équilibrage.
CONTROL - ERROR	04, 06 - 09	Erreur du verrouillage ou de la fermeture du capot.	- Ouvrir le capot. - REINITIALISER RESEAU
N > MAX	05	Survitesse	
N < MIN	13	Vitesse trop basse	
ROTORCODE	10	Erreur codage du rotor	
MAINS INTERRUPT	---	Coupure réseau, centrifugation inachevée	
VERSIONS-ERROR	12	Pas de correspondance entre les composants électroniques	- Ouvrir le capot. - REINITIALISER RESEAU
CONTROL-ERROR	21 - 27	Erreur / défautuosité de la commande	
SER I/O - ERROR	30 - 38	Erreur / défautuosité de l'interface	
° C * - ERROR	50 - 56	Erreur / défautuosité du refroidissement	
LOCK - ERROR	57	Erreur / défautuosité verrouillage du programme	
FU / CCI - ERROR	60 - 83	Erreur / défautuosité de la commande du moteur	- Vérifier la vitesse du programme sélectionnée - Corriger la vitesse du programme sélectionnée
N > ROTOR-MAX	---	Vitesse de rotation paramétrée dans le programme sélectionné supérieure à la vitesse maximale de rotation du rotor.	

24 Réparation des centrifugeuses

Dans le cas où la centrifugeuse est expédiée au fabricant pour réparation, elle doit être décontaminée et nettoyée avant expédition, dans le but d'assurer la protection des personnes, de l'environnement et du matériel.

Nous nous réservons le droit de refuser les centrifugeuses contaminées.

Nous facturons au client les frais de nettoyage et de désinfection.

Vous voudrez bien manifester votre compréhension pour cette réglementation.

Vous trouverez d'autres informations sur notre page Internet : <http://www.HettichLab.com>

Indice

1	Funzione della centrifuga	29
2	Indicazioni inerenti la sicurezza	29
3	Simboli relativi alle indicazioni	30
4	Contenuto della fornitura	30
5	Disimballo della centrifuga.....	30
6	Messa in funzione.....	30
7	Apertura e chiusura del coperchio	30
7.1	Apertura del coperchio	30
7.2	Chiusura del coperchio	30
8	Installazione e disinstallazione del rotore	31
9	Carico del rotore.....	31
10	Chiudere i rotori ad angolo a tenuta ermetica in modo da impedire la fuoriuscita di aerosol.....	31
11	Elementi di operazione e visualizzazione	31
11.1	Simboli del display	31
11.2	Tasti del display	31
11.3	Possibilità di regolazione	32
12	Inserire i parametri di centrifugazione.....	32
13	Programmazione	32
13.1	Inserimento/Variatione del programma	32
13.2	Richiamo del programma	32
14	Centrifugazione	33
14.1	Centrifugazione con tempo preimpostato	33
14.2	Corsa continua.....	33
14.3	Centrifugazione breve.....	33
15	Arresto di emergenza	33
16	Segnale acustico	33
17	Consultazione delle ore di funzionamento.....	33
18	Raffreddamento (solo per centrifuga con raffreddamento).....	34
18.1	Raffreddamento-Standby.....	34
18.2	Pre-raffreddamento del rotore.....	34
19	Centrifugazione di materiali con elevata densità	34
20	Riconoscimento del rotore	34
21	Sblocco di emergenza	34
22	Pulizia e manutenzione	35
22.1	Centrifuga	35
22.2	Rotori ed accessori	35
22.2.1	Perni di trascinamento	35
22.3	Mantenere in autoclave.....	35
22.4	Rottura del vetro	35
23	Guasti	36
24	Accettazione di centrifughe da riparare	36
25	Anhang / Appendix	37
25.1	Technische Daten / Technical specification	37
25.2	Rotoren und Zubehör / Rotors and accessories	38

1 Funzione della centrifuga

La centrifuga serve alla separazione di sostanze, ovvero di miscele di sostanze dalla densità di max. 1,2 kg/dm³.

2 Indicazioni inerenti la sicurezza



- La centrifuga è costruita in base all'attuale livello tecnologico e le regole di sicurezza conosciute.
 - La centrifuga può essere tuttavia fonte di pericolo per l'operatore o per terzi, se non viene utilizzata da personale appositamente addestrato o se viene utilizzata in modo improprio o non conforme alla destinazione.
- Prima di mettere in funzione la centrifuga si devono leggere ed osservare le istruzioni per l'uso.
- Oltre alle istruzioni per l'uso, si devono osservare anche i regolamenti, relativi alla protezione antinfortunistica ed i regolamenti tecnici, riconosciuti in materia di sicurezza del lavoro. Le istruzioni per l'uso vanno completate dalle norme nazionali in vigore nel paese d'impiego, relative alla protezione antinfortunistica ed alla tutela ambientale.
- La centrifuga deve venire posizionata in modo sicuro.
- Durante l'esercizio bisogna evitare di muovere la centrifuga o di urtarvi contro.
- Per evitare danni causati dalla condensa, quando la centrifuga viene portata da un ambiente freddo in un ambiente caldo bisogna portare la centrifuga a temperatura d'esercizio mettendola in funzione per 30 minuti nell'ambiente freddo oppure farla riscaldare per almeno 3 ore nell'ambiente caldo prima di collegarla alla rete.
- Il carico massimo dei recipienti della centrifuga deve corrispondere alle indicazioni del costruttore.
 - I recipienti devono essere riempiti fuori dalla centrifuga.
- Lo standard dei recipienti di vetro centrifugati sono da caricare fino a RCF 4000 (DIN 58970 capoverso 2).
- I contenitori della centrifuga possono essere utilizzati solo con accessori (riduttori, basi e sospensioni) approvati dal costruttore (vedere sezione "Anhang/Appendix, Rotoren und Zubehör/Rotors and accessories").
- In caso di centrifugazione con massimo numero di giri, la densità dei materiali o delle miscele di materiali non deve superare il valore di composizione di 1,2 kg/dm³.
- Non è consentito l'uso di centrifughe non bilanciate in modo regolamentare.
- Non è consentito il funzionamento della centrifuga in locali esposti al pericolo di esplosioni.
- E' proibito l'uso di una centrifuga con:
 - materiali infiammabili od esplosivi
 - materiali che possono reagire chimicamente tra loro con forte energia.
- Se vengono centrifugate sostanze pericolose o miscele di sostanze contaminate da micro organismi tossici, radioattivi o patogeni, l'utente dovrà prendere opportuni provvedimenti in materia. Senza l'aggiunta di coperchi sigillati sui rotori o contenitori, la centrifuga non può essere considerata a tenuta di aerosol in accordo al regolamento internazionale EN 61010-2-20.

Nel caso di materiali appartenenti al gruppo a rischio II (vedi manuale "Laboratory Biosafety Manual" dell'Organizzazione mondiale per la salute) si deve utilizzare un sistema di sicurezza biologico. La guarnizione biologica (guarnizione ad anello) di questo sistema di sicurezza biologico impedisce la fuoriuscita delle goccioline e degli aerosol tra la sospensione ed il coperchio. Per la centrifugazione si possono inoltre utilizzare i recipienti normalmente reperibili, dotati di tappi speciali a vite per sostanze pericolose.

Se vengono centrifugati materiali appartenenti ad un gruppo a rischio superiore, si dovrà attuare più di un provvedimento di sicurezza, ossia i recipienti dotati di tappi speciali a vite devono essere centrifugati in un sistema di sicurezza biologico.
- Per quanto riguarda i sistemi biologici di sicurezza fornibili, rimandiamo al capitolo "Anhang/Appendix, Rotoren und Zubehör/Rotors and accessories". Nel dubbio chiedere maggiori informazioni al produttore o importatore.
- Non è consentito il funzionamento della centrifuga con sostanze altamente corrosive che possono pregiudicare la resistenza meccanica dei rotori, delle sospensioni e degli accessori.
- Rotori, sospensioni ed accessori che presentano tracce di corrosione o guasti meccanici non devono essere usati per centrifugare.
- Gli interventi di riparazione devono essere effettuati esclusivamente da una persona autorizzata dal costruttore.
- Devono essere impiegati solo ed esclusivamente pezzi di ricambio originali ed accessori autorizzati della ditta Hettich.
- In caso di guasto, ovvero del ripristino d'emergenza, non si deve assolutamente toccare il rotore.
- La centrifuga è un'apparecchiatura del gruppo 3 della Disposizione medica sulle apparecchiature MedGV.
- Norme di sicurezza in conformità con
 - IEC 1010-1/-2
 - DIN - EN61010 parte 1,2
- La sicurezza e l'affidabilità della centrifuga sono garantite solo se:
 - la centrifuga funziona in conformità con le istruzioni per l'uso
 - l'installazione elettrica sul luogo di posizionamento della centrifuga risponde ai requisiti previsti dalla IEC
 - i controlli previsti in base a UVV-VBG7z vengono eseguiti da un perito esperto in materia.
- Usando la centrifuga per sistemi automatici (ROTANTA 46 robotic) porre attenzione alle note sull'uso della chiave di accesso.

Non si possono far valere diritti di garanzia presso il costruttore in caso di mancata osservanza delle presenti indicazioni.

3 Simboli relativi alle indicazioni



Attenzione: attenersi alla documentazione!



Caricare in modo uniforme il rotore della centrifuga.
Tutti i posti dei rotori devono essere assegnati.



Non riempire nella centrifuga i contenitori centrifuganti.

4 Contenuto della fornitura

- 1 cavo elettrico
- 1 chiave a forcella
- 1 Chiave di sblocco
- 1 grasso per perni portanti
- 1 istruzioni per l'uso
- 1 istruzioni per la sicurezza durante il trasporto

Rotore/i e i corrispondenti accessori vengono forniti in base alla commessa.

5 Disimballo della centrifuga

- Levare il cartone verso l'alto e togliere l'imbottitura.
- Con il numero adeguato di persone, sollevare la centrifuga da entrambi i lati e riporla sul tavolo di laboratorio.



Non sollevarla dalla copertura anteriore.

6 Messa in funzione

- In base alla normativa per gli strumenti di laboratorio EN 61010-2-20 gli impianti domestici devono essere provvisti di apposito sezionatore d'emergenza per l'interruzione della rete in caso di guasto. L'interruttore deve essere posizionato distante dalla centrifuga, preferibilmente al di fuori della stanza in cui è posizionata la centrifuga o vicino all'uscita.
- Porre la centrifuga in un posto adatto e livellarla. Per il posizionamento, si deve rispettare il settore di sicurezza richiesto dalla IEC 1010-2-2, di 300 mm attorno alla centrifuga.



Durante il funzionamento della centrifuga non si devono trovare persone o sostanze pericolose entro l'area di sicurezza.

- Non posizionare alcun oggetto in prossimità delle griglie di ventilazione. Mantenere un'area di ventilazione di 300 mm, intorno al condotto.
- Verificare se la tensione di rete sia adatta all'indicazione riportata nella targhetta con i dati caratteristici.
- Collegare la centrifuga ad una spina standard di rete tramite il cavo di collegamento.
- Accendere l'interruttore di rete. Posizione di accensione "I".
Il tipo di apparecchio e la versione del programma vengono segnalati e dopo 8 sec. seguono gli ultimi dati di centrifugazioni impiegati.
- Aprire il coperchio.
- Rimuovere la protezione per il trasporto, vedi le istruzioni per la sicurezza durante il trasporto".

7 Apertura e chiusura del coperchio

7.1 Apertura del coperchio

- Tirare verso l'alto la barra d'impugnatura sita sul coperchio. Il LED  si spegne.
- Aprire il coperchio.



E' possibile aprire il coperchio solo se la centrifuga è accesa ed il rotore è fermo.
Se non dovesse essere possibile, vedi capitolo "Sblocco di emergenza".

7.2 Chiusura del coperchio

- Appoggiare il coperchio e abbassare la barra d'impugnatura sita sul coperchio. Si accende il LED .



Non chiudere il coperchio sbattendolo.

8 Installazione e disinstallazione del rotore

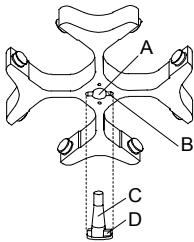

Fig. 4

- Pulire l'albero motore (C) ed il foro del rotore (A), successivamente lubrificare leggermente l'albero motore. Particelle di sporco tra l'albero motore ed il rotore impediscono un normale funzionamento del rotore e causano un movimento rumoroso.
- Porre il rotore in senso verticale sull'albero motore. Il meccanismo di trascinamento dell'albero motore (D) deve trovarsi nella scanalatura del rotore (B). Sul rotore è segnato l'allineamento della scanalatura.
- Stringere il dado di registrazione di tensione del rotore con l'aiuto della chiave inclusa nel cartone, ruotandola in senso orario.
- Verificare che il rotore sia fissato.
- Disinstallare il rotore: svitare il dado di registrazione di tensione, ruotandolo in senso anti-orario fino a che non abbia raggiunto il punto di completo svitamento. Con il punto di svitamento completo, il rotore si può smontare dal cono dell'albero motore. Girare il dado di registrazione di tensione fino a che diventi possibile smontare il rotore dall'albero motore.

9 Carico del rotore

- Nel caso di rotori oscillanti, tutti i siti del rotore devono essere muniti di ganci.
- I rotori ed i ganci devono essere caricati esclusivamente in modo simmetrico. Per le combinazioni permesse vedere capitolo "Anhang/Appendix, Rotoren und Zubehör/Rotors and accessories".
- Nel caso di contenitori con inserimenti in gomma, deve essere sempre mantenuto lo stesso numero di inserimenti in gomma sotto i contenitori di centrifugazione.
- Riempire i recipienti della centrifuga all'esterno della centrifuga stessa.
- Fare attenzione che non giunga alcuna sostanza liquida nella camera di centrifugazione durante il carico ed l'oscillazione dei ganci.
- Per limitare al massimo le differenze di peso all'interno dei contenitori di centrifugazione, bisogna fare attenzione che siano riempiti tutti in modo uguale.
- Su ogni rotore è indicato il peso della quantità di riempimento consentita. Tale peso non deve mai essere superato.

10 Chiudere i rotori ad angolo a tenuta ermetica in modo da impedire la fuoriuscita di aerosol

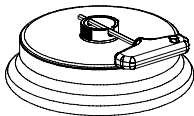

Fig. 5

Per garantire la tenuta di aerosol, i coperchi di rotori anti aerosol devono essere avvitati mediante la chiave compresa nella fornitura.

Per avvitare o allentare il coperchio, introdurre la chiave compresa nella fornitura nel foro nel coperchio, vedi Fig. 5.

Per i rotori ad angolo anti-aerosol disponibili, vedi capitolo "Anhang/Appendix, Rotoren und Zubehör/Rotors and accessories".

11 Elementi di operazione e visualizzazione

Aprire il retro della copertina

Fig. 2, Fig. 3: Display

11.1 Simboli del display



Indicazione di squilibrio. L'indicazione di squilibrio si illumina nel caso in cui la differenza di peso permessa nel carico del rotore sia stata superata.



Indicazione di rotazione. L'indicazione di rotazione si illumina durante la centrifugazione, fino a che il rotore giri.



Indicazione del coperchio. L'indicazione del coperchio si illumina quando il coperchio è chiuso e serrato. Durante la centrifugazione, l'indicazione del coperchio si spegne.

Errori di operazione (o guasti riscontrati) vengono segnalati nel display (vedere capitolo "Guasti").

11.2 Tasti del display







Tasto di selezione per selezionare i singoli parametri. Premendo successivamente questo tasto viene selezionato il parametro successivo.







Premendo i tasti con la freccia viene aumentato o diminuito il valore di un parametro selezionato precedentemente. Tenendo un tasto con la freccia premuto, si può aumentare o diminuire il valore più rapidamente.



Iniziare la centrifugazione. L'indicazione di rotazione  si illumina. Accettazione di inserimenti e modificazioni.







-  **STOP** Finire la centrifugazione.
Il rotore rallenta gradualmente con il livello di frenatura preselezionato. Il segnale luminoso rimane acceso fino a che il rotore non si arresta.
Per attivare L'ARRESTO DI EMERGENZA, premere due volte questo tasto.
-  **RCF** Selezionare l'indicazione RCF.
Il segnale luminoso nel tasto è acceso.
-  **IMPULS** Centrifugazione breve.
La centrifugazione avviene fino a che il tasto viene tenuto premuto.
-  **PROG** Salvare e richiamare i programmi.
Premendo successivamente il tasto, compaiono i programmi successivi (1 - 2 - 3 - #)



11.3 Possibilità di regolazione

- t/min Regolabile da 1 a 99 min, in passi da 1 min.
- t/sec Regolabile da 1 a 59 s, in passi da 1 sec.
- ∞ Corsa continua
- RPM Numero di giri. È impostabile un valore numerico di 500 rpm fino al numero di giri massimo del rotore. Per il numero di giri massimo del rotore, vedi capitolo "Anhang/Appendix, Rotoren und Zubehör/Rotors and accessories". Regolabile da 500 rpm a 10000 rpm ad intervalli di 10 e, a partire da 10000 rpm, fino al numero di giri massimo ad intervalli di 100.
- RAD/mm Raggio di centrifugazione. Inserimento in mm. Per il raggio di centrifugazione, vedere capitolo "Anhang/Appendix, Rotoren und Zubehör/Rotors and accessories". L'inserimento del raggio è possibile solo se l'indicazione RCF è selezionata (il segnale luminoso del tasto  è acceso).
- RCF Acceleramento relativo della centrifuga. È impostabile un valore numerico con il quale si ottiene un numero di giri compreso tra 500 rpm ed il numero di giri massimo del rotore. Regolabile fino a 100 in passi da 1 e da 100 in passi da 10. Il valore RCF viene automaticamente arrotondato per eccesso o per difetto al passo del numero di giri. L'inserimento del RCF è possibile solo se l'indicazione RCF è stata selezionata (il segnale luminoso del tasto  è acceso).
-  Livelli di inizio 1 - 9. Livello 9 = tempo di avvio più breve, livello 1 = tempo di avvio più lungo
-  Livelli di frenatura 0 - 9. Livello 9 = tempo di arresto più breve, livello 1 = tempo di arresto più lungo
Livello 0 = tempo di arresto più lungo (arresto non frenato).
- T/°C Valore nominale di temperatura (solo per centrifuga con raffreddamento). Regolabile da -20°C fino a +40°C, in passi da 1°C. La temperatura minima raggiungibile dipende dal rotore (vedere capitolo "Anhang/Appendix, Rotoren und Zubehör/Rotors and accessories").
- PROG Numero del programma. Possono essere salvati 3 programmi (Memoria programmi 1 - 2 - 3). La posizione di memoria programma # funge da memoria transitoria per impostazioni modificate.

12 Inserire i parametri di centrifugazione











 Nel caso in cui, dopo aver selezionato oppure durante l'inserimento di parametri, non venga premuto per 8 secondi alcun tasto, vengono indicati i valori precedenti. L'inserimento dei parametri deve essere poi eseguita nuovamente.

- Con il tasto  selezionare l'indicazione RPM oppure RCF. Se l'indicazione RCF è stata selezionata il segnale luminoso del tasto  è acceso.
- Selezionare con il tasto  i parametri desiderati e regolare con i tasti  .
Per regolare il simbolo ∞ i parametri **t/min** e **t/sec** devono essere messi a zero con il tasto .
- Dopo l'inserimento di tutti i parametri, premere il tasto  per salvare gli inserimenti nella memoria di programma #. Per conferma, viene indicata per alcuni secondi la dicitura ***** ok *****.

 I dati sulla posizione di memoria programma # vengono sovrascritti con ogni nuovo inserimento di parametri e premendo il tasto .

13 Programmazione

13.1 Inserimento/Variatione del programma

- Selezionare con il tasto  le indicazioni RPM oppure RCF. Se l'indicazione RCF è stata selezionata, il segnale luminoso del tasto  è acceso.
- Selezionare con il tasto  il parametro desiderato e regolare con i tasti  .
- Selezionare con il tasto  il parametro **PROG** e regolare con i tasti   la posizione di memoria programma desiderata. Il segnale luminoso del tasto  è acceso.
- Premere il tasto  per salvare le impostazioni nella posizione di memoria programma desiderata. Per conferma viene indicata per alcuni secondi la dicitura ***** ok *****.

13.2 Richiamo del programma

- Selezionare la posizione di memoria programma desiderata con il tasto **◻PROG**.
I dati di centrifugazione della posizione di memoria programma selezionata vengono indicati.
- I parametri possono essere verificati tramite il tasto **◀**.

14 Centrifugazione



Nel caso in cui la differenza di peso permissibile nel caricamento del rotore venga superata, si ferma l'azionamento durante l'avvio, si illumina l'indicazione di squilibrio e compare la dicitura **IMBALANCE**.

Se il numero di giri nel programma selezionato è più elevato del numero di giri massimo del rotore, non è possibile avviare un ciclo di centrifugazione. Compare la dicitura **N > ROTOR MAX** (vedere capitolo "Guasti").

Una corsa di centrifugazione può essere interrotta in ogni momento premendo il tasto **◻STOP**.

Durante la corsa di centrifugazione, può essere selezionato e modificato ogni tipo di parametro (vedere capitolo "Inserire i parametri di centrifugazione").

Con il tasto **◻RCF** è possibile commutare in ogni momento le indicazioni RPM e RCF. Se viene usata l'indicazione RCF, è necessario inserire il raggio di centrifugazione.

Se compaiono le diciture **◀ OPEN ▶ OEFFNEN (=APRIRE)**, è possibile un'operazione della centrifuga solo dopo aver aperto una volta il coperchio.

- Accendere l'interruttore di rete. Posizione di accensione I.
- Caricare il rotore e chiudere il coperchio della centrifuga.

14.1 Centrifugazione con tempo preimpostato

- Selezionare il tempo oppure richiamare un programma con tempo preimpostato (vedere capitolo "Inserire i parametri di centrifugazione" oppure "Richiamo del programma").
- Premere il tasto **◻START** drücken. L'indicazione di rotazione **↻** è accesa fino a che il rotore gira.
- Passato il tempo o con l'interruzione della corsa di centrifugazione premendo il tasto **◻STOP**, avviene l'arresto con il livello di frenatura selezionato. Il livello di frenatura viene indicato.

Durante la corsa di centrifugazione compaiono il numero di giri del rotore, il valore RCF risultante, la temperatura delle provette (solo per centrifuga con raffreddamento) ed il tempo rimanente.

14.2 Corsa continua

- Impostazione il simbolo ∞ oppure richiamare il programma di corsa continua (vedere capitolo "Inserire i parametri di centrifugazione" oppure "Richiamo del programma").
- Premere il tasto **◻START**. L'indicazione di rotazione **↻** illumina fino a che il rotore gira. Il conteggio del tempo inizia da 00:00.
- Premere il tasto **◻STOP** per terminare la centrifugazione. L'arresto avviene con il livello di frenatura selezionato. Il livello di frenatura viene indicato.

Durante la centrifugazione compaiono il numero di giri del rotore, il valore RCF risultante, la temperatura delle provette (solo per centrifuga con raffreddamento) ed il tempo intercorso.

14.3 Centrifugazione breve

- Tenere premuto il tasto **◻IMPULS**. L'indicazione di rotazione **↻** illumina fino a che il rotore gira.
- Togliere il dito dal tasto **◻IMPULS** per terminare la corsa di centrifugazione. L'arresto avviene con il livello di frenatura selezionato. Il livello di frenatura viene indicato.

Durante la centrifugazione compaiono il numero di giri del rotore, il valore RCF risultante, la temperatura delle provette (solo per centrifuga con raffreddamento) ed il tempo rimanente.

15 Arresto di emergenza

- Premere 2 volte il tasto **◻STOP**.

Con l'arresto di emergenza l'arresto avviene con il livello di frenatura 9 (arresto più breve). Il livello di frenatura 9 viene indicato.

Con il livello di frenatura preimpostato sullo 0, il tempo di arresto, per motivi tecnici, è superiore a quello raggiunto con il livello di frenatura 9.

16 Segnale acustico

Il segnale acustico si attiva quando:

- con il verificarsi di un guasto con intervallo di 3 sec
- dopo il terminare della corsa di centrifugazione e arresto del rotore con intervallo di 30 secondi





Aperto il coperchio oppure premendo un tasto qualsiasi, il segnale acustico cessa.

Il segnale che si attiva in seguito alla cessazione della corsa di centrifugazione, può essere attivato o disattivato, raggiunto l'arresto del rotore, in modo seguente:

- Tenere premuto il tasto **◻** per 8 secondi.
Dopo 8 sec. compare la dicitura **SOUND / BELL**.
- Impostare con il tasto **▲** oppure **▼** **OFF** (disinserito) oppure **ON** (inserito).
- Premere il tasto **◻START** per salvare le impostazioni. Per conferma, compare per alcuni secondi la dicitura ***** ok *****.

17 Consultazione delle ore di funzionamento

La consultazione delle ore di funzionamento è possibile solo con rotore in posizione di arresto.

- Tenere premuto il tasto  per 8 secondi.
Dopo 8 sec. Compare la dicitura **SOUND / BELL**.
- Premere nuovamente il tasto .
Compaiono le ore di funzionamento della centrifuga (**CONTROL:**).
- Per uscire dalla consultazione delle ore di funzionamento premere il tasto  oppure .

18 Raffreddamento (solo per centrifuga con raffreddamento)

Il valore nominale di temperatura può essere selezionata da -20°C fino a +40°C. La temperatura minima raggiungibile dipende dal rotore (vedere capitolo "Anhang/Appendix, Rotoren und Zubehör/Rotors and accessories").

18.1 Raffreddamento-Standby

Con l'arresto del rotore e coperchio chiuso, la camera di centrifugazione viene raffreddata alla temperatura selezionata. Nel display compare il valore nominale di temperatura.

18.2 Pre-raffreddamento del rotore

Per una rapida preraffrigerazione del rotore non carico e degli accessori è consigliabile effettuare un ciclo di centrifugazione con le impostazioni funzionamento continuo ed un numero di giri all'incirca del 20% del numero di giri massimo del rotore.

19 Centrifugazione di materiali con elevata densità

I rotori sono costruiti in modo da poter centrifugare delle sostanze dalla densità mediamente omogenea di max. 1,2 kg/dm³, con il numero di giri indicato.

Sostanze di maggiore densità devono essere centrifugate con un numero di giri ridotto.

Il numero di giri consentito si calcola con la formula seguente:

$$\text{numero di giri ridotto (n}_{\text{red}}) = \sqrt{\frac{1,2}{\text{densità maggiore}}} \times \text{numero di giri nominale}$$

p.es.: RPM 4000, densità 1,6 kg/dm³



$$n_{\text{red}} = \sqrt{\frac{1,2}{1,6}} \times 4000 = 3464 \text{ RPM}$$

In caso di dubbio, rivolgersi al costruttore per maggiori informazioni.

20 Riconoscimento del rotore

Con l'inizio di ogni corsa di centrifugazione, avviene il riconoscimento del rotore installato.

Dopo un cambio del rotore, il motore si spegne e vengono brevemente visualizzati il numero di giri massimo ed il codice del rotore.

Infine compare la dicitura  OPEN  OEFFNEN (=APRIRE), in seguito è possibile impiegare nuovamente la centrifuga solo dopo aver aperto una volta il coperchio.

Se dopo un cambio del rotore il numero di giri massimo del rotore è inferiore al numero di giri impostato, la velocità viene limitata al numero di giri massimo del rotore.

21 Sblocco di emergenza

In caso di mancanza di corrente non si può aprire il coperchio. Deve essere effettuata manualmente uno sblocco di emergenza.



Per lo sblocco di emergenza, disconnettere la centrifuga dalla rete elettrica.
Aprire il coperchio solo con l'arresto del rotore.

Aprire il retro della copertina.

- Introdurre il perno di sblocco (vedi materiale fornito) orizzontalmente nel foro (Fig. 1, A). Spingere dentro il perno di sblocco fino a che, quando si spinge il perno verso l'alto, sia possibile ribaltare la maniglia verso l'alto.
- Aprire il coperchio.

22 Pulizia e manutenzione



Prima della pulizia, staccare la presa di corrente.

Prima di iniziare un procedimento di pulizia e decontaminazione diverso da quello consigliato dal produttore, l'utilizzatore deve accertarsi presso il produttore che tale procedimento previsto non rechi danno all'apparecchio.

- Devono essere impiegati detersivi e disinfettanti con valore PH compreso tra 6 e 8. Evitare detersivi alcalini con valore PH superiore di 8.
- Seguire attentamente le indicazioni speciali del produttore sull'impiego di detersivi e disinfettanti, al fine di evitare qualsiasi fenomeno di corrosione.

22.1 Centrifuga

- Pulire costantemente il contenitore della centrifuga e della camera di centrifugazione e impiegare all'occorrenza sapone o detersivo delicato con acqua. Ciò serve da un lato per l'igiene e dall'altro lato per evitare la corrosione causata da impurità incrostate.
- In caso di formazione di acqua di condensa, asciugare la camera di centrifugazione pulendola con un panno assorbente
- In presenza di materiale infettivo nella camera di centrifugazione si deve disinfettarla immediatamente.
- Lubrificare leggermente la guarnizione in gomma della camera di centrifugazione dopo averla pulita.

22.2 Rotori ed accessori

- Per prevenire la corrosione o delle alterazioni del materiale, i rotor e gli elementi accessori devono essere puliti regolarmente con sapone oppure con un detersivo delicato e acqua. Si consiglia una pulizia settimanale oppure meglio dopo ogni utilizzo.
- In caso di sporco costituito da materiale patogeno o radioattivo nel rotore o nelle parti accessorie, bisogna effettuare una pulizia idonea.
- Dopo la pulizia, i rotor e le parti accessorie devono essere immediatamente asciugati.
- Rotori angolari, contenitori e ganci in alluminio devono essere leggermente lubrificati dopo l'asciugatura (Grasso lubrificante Hettich, no. d'ord. 4051).
- In caso di rotor a tenuta di aerosol e di sistemi di Bio-Sicurezza (vedi capitolo "Anhang/Appendix, Rotoren und Zubehör/Rotors and accessories"), gli anelli di tenuta devono essere controllati e puliti regolarmente (settimanalmente). In presenza di crepe, parti fragili o logorio, l'anello di tenuta deve essere subito sostituito.
- Per evitare la corrosione causata dall'umidità tra il rotore e l'albero motore, si deve provvedere almeno una volta al mese di smontare il rotore, pulirlo e di lubrificare leggermente l'albero motore.
- Bisogna verificare mensilmente che i rotor e le parti accessorie non siano danneggiati dalla corrosione.



Rotori ed accessori non devono essere più utilizzati se presentano consumo o corrosione

22.2.1 Perna di trascinamento

In rotor oscillanti, i perni di trascinamento devono essere lubrificati regolarmente (Grasso lubrificante Hettich no. d'ord. 4051) per consentire un'oscillazione equilibrata dei ganci.

22.3 Mantenere in autoclave

I rotor oscillanti, rotor angolari in alluminio e gli accessori possono essere riposti in autoclave a 121°C (20 min.)



Il coperchio del rotore ed il contenitore devono essere staccati prima di essere riposti in autoclave.

La conservazione in autoclave accelera il processo di invecchiamento del materiale in plastica. Inoltre può causare variazioni di colore nel materiale in plastica.

22.4 Rottura del vetro

- In caso di rottura del vetro, ripulire con cautela ogni frammento ed il materiale di centrifugazione dalla camera di centrifugazione e dal contenitore oppure dai fori dei contenitori.
- Sostituire la guarnizione in gomma.



In caso di rottura del vetro, le guarnizioni in gomma del contenitore devono essere sostituite, poiché frammenti di vetro rimasti nella guarnizione causano ulteriori rotture del vetro.

- Nel caso di materiale infettivo, bisogna provvedere immediatamente ad una disinfezione.

23 Guasti

Se l'errore non può essere riparato secondo la tabella dei guasti e se, dopo aver attivato la funzione RESET-RETE, l'errore continui a persistere, si prega di contattare il nostro Servizio Clienti Hettich.

Pregasi comunicare il tipo di centrifuga ed il numero di fabbricazione che sono riportati nella targhetta con i dati caratteristici della centrifuga.

RESET RETE: - Premere interruttore OFF, oltre 10s.
- Premere interruttore ON.

Visualizzazione/guasto		Causa	Eliminazione
Nessuna visualizzazione	---	- Non c'è tensione. - Scatto fusibile sovraccorrente.	- Controllare alimentatore elettrico. - Interruttore di rete ON.
TACHO - ERROR	01	- Tachimetro difettoso	- Aprire il coperchio.
	02	- Rotore non installato - Motore, convertitore, azionatore difettosi.	- Far girare manualmente il rotore - RESET RETE, all'inserimento il rotore deve girare.
IMBALANCE	---	Squilibrio sull'asse motore dovuto a differenze di carico del rotore.	- Aprire il coperchio. - Eliminare lo squilibrio.
CONTROL - ERROR	04, 06 - 09	Errore blocco coperchio, ovvero chiusura coperchio.	- Aprire il coperchio. - RESET RETE
N > MAX	05	N° giri eccedente	
N < MIN	13	N° giri insufficiente	
ROTORCODE	10	Errore codifica rotore	
MAINS INTERRUPT	---	Interruzione di rete, centrifugazione non terminata	- Aprire il coperchio. - Premere tasto START .
VERSIONS-ERROR	12	Non c'è corrispondenza tra i componenti elettronici	- Aprire il coperchio. - RESET RETE
CONTROL-ERROR	21 - 27	Errore/guasto lato comandi	
SER I/O - ERROR	30 - 38	Errore/guasto interfaccia	
° C * - ERROR	50 - 56	Errore/guasto raffreddamento	
LOCK - ERROR	57	Errore/guasto blocco programma	
FU / CCI - ERROR	60 - 83	Errore/guasto controllo motore	
N > ROTOR-MAX	---	Il numero di giri nel programma selezionato è superiore al numero di giri massimo del rotore.	- Verificare e correggere la velocità nel programma selezionato.

24 Accettazione di centrifughe da riparare

Nel caso in cui la centrifuga debba essere rispedita al produttore per una eventuale riparazione, prima della spedizione deve essere decontaminata e pulita a fondo a salvaguardia delle persone, dell'ambiente e del materiale.

Ci riserviamo di accettare centrifughe contaminate.

Eventuali costi di pulizia e disinfezione verranno fatturati al cliente.

Contiamo a questo riguardo sulla vostra comprensione.











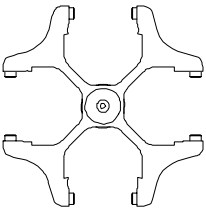

Per ulteriori informazioni cliccare sulla nostra homepage <http://www.HettichLab.com>











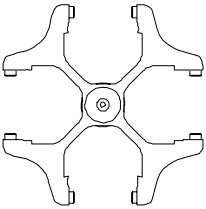

25 Anhang / Appendix

25.1 Technische Daten / Technical specification

Hersteller / Manufacturer	Hettich Zentrifugen D-78532 Tuttlingen				
Typenbezeichnung / Model	ROTINA 35		ROTINA 35 R		
Verkaufs-Nr. / Product no.	1705	1705-01	1710, 1710-20	1710-07	1710-01
Netzspannung / Mains voltage ($\pm 10\%$)	220-240 V 1~	110-127 V 1~	208-240 V 1~	220 V 1~	110-127 V 1~
Netzfrequenz / Mains frequency	50 – 60 Hz	50 – 60 Hz	50 Hz	60 Hz	60 Hz
Anschlusswert / Connected load	880 VA	760 VA	1300 VA	1300 VA	1500 VA
Stromaufnahme / Current consumption	4.2 A	7.8 A	6.5 A	6.5 A	13.5 A
Leistungsaufnahme / Power consumption	600 W	620 W	1100 W	1100 W	1200 W
Kältemittel / Refrigerant	----		R 404a		
Kapazität max. / Max. capacity	52 x 15 ml				
zulässige Dichte / Max. density	1.2 kg/dm ³				
Drehzahl / Speed RPM	15000				
Beschlg. / Force RCF	24400				
Kinetische Energie / Kinetic energy	18500 Nm		22000 Nm		
Prüfpflicht / Obligatory inspection	ja / yes				
Aufstellungsort / Environment – Umgebungstemp. / Ambient temperature – relative Feuchte / Relative humidity	2°C bis 40°C / 2°C up to 40°C		5°C bis 40°C / 5°C up to 40°C max. 80% bis 31°C, linear abnehmend bis zu 50% bei 40°C / max. 80% up to 31°C, descending in a linear pattern down to 50% at 40°C		
Probenerwärmung / Sample temp. rise	≤ 15 K		-----		
Geräteschutzklasse / Class of protection	I				
EMV / EMC – Störaussendung (Funkentstörung) / Emission (Radio interference suppression) – Störsicherheit / Immunity	ISM (Industrial Science Medicine) EN 55011 Klasse B / Class B FCC Class B EN 55011 Klasse B / Class B FCC Class B gemäß EN 50082-2 / according to EN 50082-2				
Geräuschpegel (rotorabhängig) / Noise level (dependent on rotor)	52 up to 66 dB(A)		46 up to 66 dB(A)		
Abmessungen / Dimensions • Breite / Width • Tiefe / Depth • Höhe / Height	468 mm 540 mm 380 mm		468 mm 695 mm 380 mm		
Gewicht ca. / Weight approx.	43.1 kg		70 kg		











25.2 Rotoren und Zubehör / Rotors and accessories



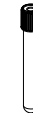







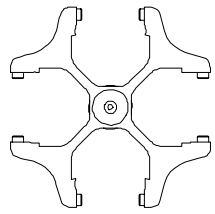

1724		1427 1424							
Ausschwingrotor 4-fach / Swing out rotor 4-times  ↙ 90°		Reduzierung / adapter							
		1357	1327	5529	5230	5237	5231	5232	5233
		Röhrchen / tube							
		Rhesus							
									
Kapazität / capacity	ml	1	3	6	7	9	15	25	50
Maße / dimensions	∅ x L	6 x 45	10 x 60	12 x 82	12 x 100	14 x 100	17 x 100	24 x 100	34 x 100
Anzahl p. Gestell / number p. frame		30	12	12	12	6	6	2	1
Anzahl p. Rotor / number p. rotor		120	48	48	48	24	24	8	4
Drehzahl / speed	RPM	5000	5000	5000	5000	5000	5000	5000	5000
RZB / RCF		4388	4360	4360	4276	4276	4276	4276	4276
Radius / radius	mm	157	156	156	153	153	153	153	153
 9 (97%)	sec	16	16	16	16	16	16	16	16
 9	sec	19	19	19	19	19	19	19	19
 0	sec	232	232	232	232	232	232	232	232
Temperatur / temperature	°C ¹⁾	-7	-7	-7	-7	-7	-7	-7	-7

1724		1427 1421							
Ausschwingrotor 4-fach / Swing out rotor 4-times  ↙ 90°		Gestell / frame							
		5278	5229		5230 ³⁾	1732 ³⁾		5279	
		Röhrchen / tube							
		Sarstedt	Sarstedt	Sarstedt	Sarstedt	Sarstedt	Sarstedt	Sarstedt	Sarstedt
									
Kapazität / capacity	ml	1,1 – 1,4	2,7 – 3	4	4,5 – 5	2,6 – 2,9	4,9	4 – 5,5	7,5 – 8,2
Maße / dimensions	∅ x L	8,5 x 66	11,5 x 66	11,5 x 84	11,5 x 92	13 x 65	13 x 90	15,3 x 75	15,3 x 92
Anzahl p. Gestell / number p. frame		12	12	12	12	8	8	8	8
Anzahl p. Rotor / number p. rotor		48	48	48	48	32	32	20	20
Drehzahl / speed	RPM	5000	5000	5000	5000	5000	5000	5000	5000
RZB / RCF		4416	4360	4360	4276	4360	4360	4416	4416
Radius / radius	mm	158	156	156	153	156	156	158	158
 9 (97%)	sec	16	16	16	16	16	16	16	16
 9	sec	19	19	19	19	19	19	19	19
 0	sec	232	232	232	232	232	232	232	232
Temperatur / temperature	°C ¹⁾	-7	-7	-7	-7	-7	-7	-7	-7

1) Tiefste erreichbare Temperatur bei maximaler Drehzahl und 1 Stunde Laufzeit (nur bei Kühlzentrifuge)
 3) nicht mit Deckel verschließbar

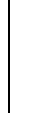









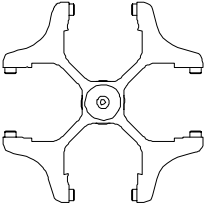

1) Lowest possible temperature during maximum speed and 1 hour running time (only with cooling centrifuges)
 3) not possible to close the lid











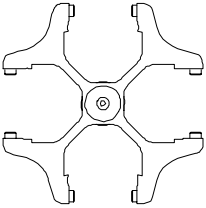

1724	1427 1421								
Ausschwingrotor 4-fach / Swing out rotor 4-times 									
	Reduzierung / adapter								
	5271 ohne Gummieinlage / without rubber insert	1731	5229	1732 ³⁾			5271	5231 ³⁾	1733 ³⁾
	Röhrchen / tube								
	Sarstedt	Sarstedt	Vacutainer	Vacutainer	Vacutainer	Vacutainer	Vacutainer	Vacutainer	0509
									
Kapazität / capacity ml	9 - 10	25	2	1,6 - 5	4 - 7	4 - 7	8,5 - 10	15	
Maße / dimensions Ø x L mm	16,5 x 92	25 x 92	10 x 64	13 x 75	13 x 100	16 x 75	16 x 100	17 x 120	
Anzahl p. Gestell/number p. frame	5	2	12	8	8	5	6	3	
Anzahl p. Rotor / number p. rotor	20	8	48	32	32	20	24	12	
Drehzahl / speed RPM	5000	5000	5000	5000	5000	5000	5000	5000	
RZB / RCF	4340	4332	4360	4360	4360	4304	4276	4472	
Radius / radius mm	154	155	156	156	156	154	153	160	
 9 (97%) sec	16	16	16	16	16	16	16	16	
 9 sec	19	19	19	19	19	19	19	19	
 0 sec	232	232	232	232	232	232	232	232	
Temperatur / temperature °C ¹⁾	-7	-7	-7	-7	-7	-7	-7	-7	

1724	1427 1421					1425				
Ausschwingrotor 4-fach / Swing out rotor 4-times 										
	Gestell / frame					Reduzierung / adapter				
	5276 ³⁾	5277	5273	1432	1433	1434		1431		
	Röhrchen / tube									
	0513	2078	0536	2078	0536	Rhesus				
										
Kapazität / capacity ml	50	1,5	2,0	1,5	2,0	1	3	6	7	9
Maße / dimensions Ø x L mm	29 x 115	11 x 38		11 x 38		6 x 45	10 x 60	12 x 82	12 x 100	14 x 100
Anzahl p. Gestell/number p. frame	1	9		12		36	14	12	12	7
Anzahl p. Rotor / number p. rotor	4	36		48		144	56	48	48	28
Drehzahl / speed RPM	5000	5000		5000		5000	5000	5000	5000	5000
RZB / RCF	4360	4388		4332		4304	4248	4248	4248	4248
Radius / radius mm	156	157		155		152	152	152	152	152
 9 (97%) sec	16	16		16		16	16	16	16	16
 9 sec	19	19		19		19	19	19	19	19
 0 sec	232	232		232		232	232	232	232	232
Temperatur / temperature °C ¹⁾	-7	-7		-7		-7	-9	-9	-9	-9

- 1) Tiefste erreichbare Temperatur bei maximaler Drehzahl und 1 Stunde Laufzeit (nur bei Kühlzentrifuge)
 3) nicht mit Deckel verschließbar











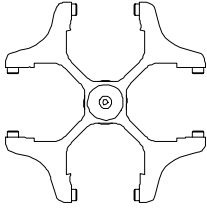

- 1) Lowest possible temperature during maximum speed and 1 hour running time (only with cooling centrifuges)
 3) not possible to close the lid

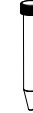









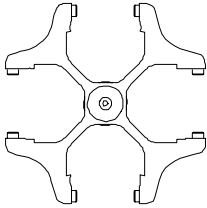

1724		1425								
Ausschwingrotor 4-fach / Swing out rotor 4-times  90°		Reduzierung / adapter				Gestell / frame				
		1431	1435	1436	1437	1458	1438			
		Röhrchen / tube								
										
Kapazität / capacity	ml	15	25	50	100	1,1 – 1,4	2,7 – 3	4	4,5 – 5	
Maße / dimensions	Ø x L	mm	17 x 100	24 x 100	34 x 100	44 x 100	8,5 x 66	11,5 x 66	11,5 x 84	11,5 x 92
Anzahl p. Gestell / number p. frame		7	2	1	1	9	7	7	7	
Anzahl p. Rotor / number p. rotor		28	8	4	4	36	28	28	28	
Drehzahl / speed	RPM	5000	5000	5000	5000	5000	5000	5000	5000	
RZB / RCF		4248	4248	4248	4248	4360	4248	4248	4248	
Radius / radius	mm	152	152	152	152	156	152	152	152	
 9 (97%)	sec	16	16	16	16	16	16	16	16	
 9	sec	19	19	19	19	19	19	19	19	
 0	sec	232	232	232	232	232	232	232	232	
Temperatur / temperature	°C ¹⁾	-7	-7	-7	-7	-9	-9	-9	-9	

1724		1425								
Ausschwingrotor 4-fach / Swing out rotor 4-times  90°		Gestell / frame								
		1438		1461			1439	1440	1438	
		Röhrchen / tube								
										
Kapazität / capacity	ml	2,6 – 2,9	4,9	3,2 – 6	4 – 5,5	7,5 – 8,5	9 – 10	25	2	
Maße / dimensions	Ø x L	mm	13 x 65	13 x 90	15,3 x 57	15,3 x 75	15,3 x 92	16,5 x 92	25 x 92	10 x 64
Anzahl p. Gestell / number p. frame		7	7	4	4	4	4	1	7	
Anzahl p. Rotor / number p. rotor		28	28	16	16	16	16	4	28	
Drehzahl / speed	RPM	5000	5000	5000	5000	5000	5000	5000	5000	
RZB / RCF		4248	4248	4360	4360	4360	4248	4248	4248	
Radius / radius	mm	152	152	156	156	156	152	152	152	
 9 (97%)	sec	16	16	16	16	16	16	16	16	
 9	sec	19	19	19	19	19	19	19	19	
 0	sec	232	232	232	232	232	232	232	232	
Temperatur / temperature	°C ¹⁾	-9	-9	-9	-9	-9	-9	-9	-9	

1) Tiefste erreichbare Temperatur bei maximaler Drehzahl und 1 Stunde Laufzeit (nur bei Kühlzentrifuge)











1) Lowest possible temperature during maximum speed and 1 hour running time (only with cooling centrifuges)

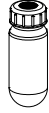
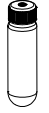

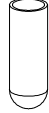

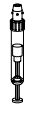





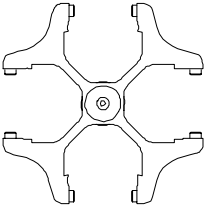

1724		1425								
Ausschwingrotor 4-fach / Swing out rotor 4-times  90°		Gestell / frame								
		1438		1441		1736	1443	1737	1444	
		Röhrchen / tube								
		Vacutainer	Vacutainer	Vacutainer	Vacutainer	0509	0513	Falcon	2078	0536
										
Kapazität / capacity	ml	1,6 – 5	4 – 7	4 – 7	8,5 – 10	15	50	50	1,5	2,0
Maße / dimensions	∅ x L mm	13 x 75	13 x 100	13 x 75	13 x 100	17 x 120	29 x 115	29 x 115	11 x 38	
Anzahl p. Gestell/number p. frame		7	7	7	7	4	1	1	9	
Anzahl p. Rotor / number p. rotor		28	28	28	28	16	4	4	36	
Drehzahl / speed	RPM	5000	5000	5000	5000	5000	5000	5000	5000	
RZB / RCF		4248	4248	4248	4248	4416	4416	4416	4220	
Radius / radius	mm	152	152	152	152	158	158	148	151	
 9 (97%)	sec	16	16	16	16	16	16	16	16	
 9	sec	19	19	19	19	19	19	19	19	
 0	sec	252	252	252	252	252	252	252	252	
Temperatur / temperature	°C ¹⁾	- 9	- 9	- 9	- 9	- 9	- 9	- 9	- 9	

1724		1430				1382						
Ausschwingrotor 4-fach / Swing out rotor 4-times  90°		Reduzierung / adapter										
		1339		1343		1383		1329		1330		1331
		Röhrchen / tube										
		Rhesus										
												
Kapazität / capacity	ml	1	3	6	7	9	15	25	50			
Maße / dimensions	∅ x L mm	6 x 45	10 x 60	12 x 82	12 x 100	14 x 100	17 x 100	24 x 100	34 x 100			
Anzahl p. Gestell/number p. frame		27	9	5	5	4	4	1	1			
Anzahl p. Rotor / number p. rotor		108	36	20	20	16	16	4	4			
Drehzahl / speed	RPM	5000	5000	5000	5000	5000	5000	5000	5000			
RZB / RCF		4416	4444	4388	4388	4332	4332	4165	4137			
Radius / radius	mm	158	159	157	157	155	155	149	148			
 9 (97%)	sec	16	16	16	16	16	16	16	16			
 9	sec	19	19	19	19	19	19	19	19			
 0	sec	232	232	232	232	232	232	232	232			
Temperatur / temperature	°C ¹⁾	- 10	- 10	- 10	- 10	- 10	- 10	- 10	- 10			

1) Tiefste erreichbare Temperatur bei maximaler Drehzahl und 1 Stunde Laufzeit (nur bei Kühlzentrifuge)

1) Lowest possible temperature during maximum speed and 1 hour running time (only with cooling centrifuges)



1724		1430				1382			
Ausschwingrotor 4-fach / Swing out rotor 4-times  		Reduzierung / adapter							
		1396	4416	4417	0761	1457	1383		
		Röhrchen / tube							
		0547	0546	0545		Sarstedt	Sarstedt	Sarstedt	Sarstedt
									
Kapazität / capacity	ml	85	50	30	100	1,1 – 1,4	2,7 – 3	4	4,5 - 5
Maße / dimensions	Ø x L mm	38 x 106	29 x 107	26 x 95	44 x 100	8,5 x 66	11,5 x 66	11,5 x 66	11,5 x 92
Anzahl p. Gestell / number p. frame		1	1	1	1	7	5	5	5
Anzahl p. Rotor / number p. rotor		4	4	4	4	28	20	20	20
Drehzahl / speed	RPM	5000	5000	5000	5000	5000	5000	5000	5000
RZB / RCF		4444	4472	4193	4360	4388	4388	4388	4388
Radius / radius	mm	159	160	150	156	157	157	157	157
 9 (97%)	sec	16	16	16	16	16	16	16	16
 9	sec	19	19	19	19	19	19	19	19
 0	sec	232	232	232	232	232	232	232	232
Temperatur / temperature	°C ¹⁾	- 10	- 10	- 10	- 10	- 10	- 10	- 10	- 10

1724		1430				1382			
Ausschwingrotor 4-fach / Swing out rotor 4-times  		Gestell / frame							
		1383	1459		1329	1330	1383		
		Röhrchen / tube							
		Sarstedt	Sarstedt	Sarstedt	Sarstedt	Sarstedt		Vacutainer	Vacutainer
									
Kapazität / capacity	ml	2,6 – 2,9	4,9	4- 5,5	7,5 – 8,2	9 - 10	25	2	1,6 – 5
Maße / dimensions	Ø x L mm	13 x 65	13 x 90	15,3 x 75	15,3 x 92	16,5 x 92	25 x 92	10 x 64	13 x 75
Anzahl p. Gestell / number p. frame		5	5	4	4	4	1	5	5
Anzahl p. Rotor / number p. rotor		20	20	16	16	16	4	20	20
Drehzahl / speed	RPM	5000	5000	5000	5000	5000	5000	5000	5000
RZB / RCF		4388	4388	4388	4388	4332	4165	4388	4399
Radius / radius	mm	157	157	157	157	155	149	157	157
 9 (97%)	sec	16	16	16	16	16	16	16	16
 9	sec	19	19	19	19	19	19	19	19
 0	sec	232	232	232	232	232	232	232	232
Temperatur / temperature	°C ¹⁾	- 10	- 10	- 10	- 10	- 10	- 10	- 10	- 10

1) Tiefste erreichbare Temperatur bei maximaler Drehzahl und 1 Stunde Laufzeit (nur bei Kühlzentrifuge)



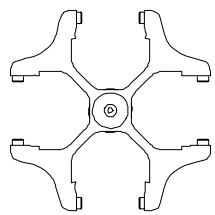







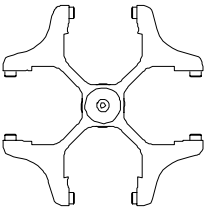



1) Lowest possible temperature during maximum speed and 1 hour running time (only with cooling centrifuges)









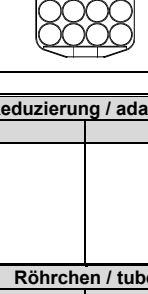
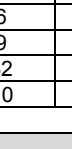

1724		1430			1382				
Ausschwingrotor 4-fach / Swing out rotor 4-times  $\angle 90^\circ$		Gestell / frame							
		1383	1348		1347	1384	1351	0765 Gummi- einlage / Rubber insert	
		Röhrchen / tube							
		Vacutainer	Vacutainer	Vacutainer	0509	0513	2078	0536	VK 0534 Chrombadröhrchen Chromium-bath tubes Skal. 10µl-300µl, 15ml, 30ml VK 0535 Deckel (Gummi) Lid (rubber)
Kapazität / capacity	ml	4 - 7	4 - 7	8,5 - 10	15	50	1,5	2,0	30
Maße / dimensions	∅ x L	mm	13 x 100	16 x 75	16 x 100	17 x 120	29 x 115	11 x 38	44 x 105
Anzahl p. Gestell/number p. frame		5	4	4	1	1	5	1	
Anzahl p. Rotor / number p. rotor		20	16	16	4	4	20	4	
Drehzahl / speed	RPM	5000	5000	5000	5000	5000	5000	5000	
RZB / RCF		4388	4388	4388	4528	4528	4193	4332	
Radius / radius	mm	157	157	157	162	162	150	155	
9 (97%)	sec	16	16	16	16	16	16	16	
9	sec	19	19	19	19	19	19	19	
0	sec	232	232	232	232	232	232	232	
Temperatur / temperature	°C ¹⁾	- 10	- 10	- 10	- 10	- 10	- 10	- 10	













1724		1429			
Ausschwingrotor 4-fach / Swing out rotor 4-times  $\angle 90^\circ$					
		Reduzierung / adapter			
		Röhrchen / tube			
Kapazität / capacity	ml	5	5	6	
Maße / dimensions	∅ x L	mm	13,5 x 75	12 x 75	12 x 82
Anzahl p. Gestell/number p. frame		19	19	19	
Anzahl p. Rotor / number p. rotor		76	76	76	
Drehzahl / speed	RPM	5000	5000	5000	
RZB / RCF		4081	4081	4081	
Radius / radius	mm	146	146	146	
9 (97%)	sec	16	16	16	
9	sec	19	19	19	
0	sec	232	232	232	
Temperatur / temperature	°C ¹⁾	- 10	- 10	- 10	



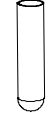



1) Tiefste erreichbare Temperatur bei maximaler Drehzahl und 1 Stunde Laufzeit (nur bei Kühlzentrifuge)

1) Lowest possible temperature during maximum speed and 1 hour running time (only with cooling centrifuges)

1724		1734							
Ausschwingrotor 4-fach / Swing out rotor 4-times 									
		Reduzierung / adapter							
		Röhrchen / tube							
				Vacutainer		Vacutainer		Sarstedt	
									
Kapazität / capacity	ml	9	15	1,6 - 5	4 - 7	4 - 7	8,5 - 10	2,6 - 2,9	4,9
Maße / dimensions	∅ x L mm	14 x 100	17 x 100	13 x 75	13 x 100	16 x 75	16 x 100	13 x 65	13 x 90
Anzahl p. Gestell/number p. frame		12	12	12	12	12	12	12	12
Anzahl p. Rotor / number p. rotor		48	48	48	48	48	48	48	48
Drehzahl / speed	RPM	5000	5000	5000	5000	5000	5000	5000	5000
RZB / RCF		4388	4388	4388	4388	4388	4388	4388	4388
Radius / radius	mm	157	157	157	157	157	157	157	157
 9 (97%)	sec	16	16	16	16	16	16	16	16
 9	sec	19	19	19	19	19	19	19	19
 0	sec	232	232	232	232	232	232	232	232
Temperatur / temperature	°C ¹⁾	- 10	- 10	- 10	- 10	- 10	- 10	- 10	- 10

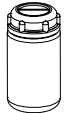
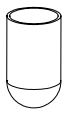









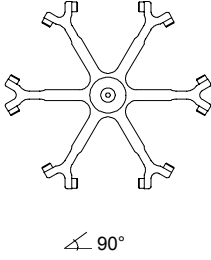

1724		1734				
Ausschwingrotor 4-fach / Swing out rotor 4-times 						
		Reduzierung / adapter				
		Röhrchen / tube				
				Sarstedt		Sarstedt
						
Kapazität / capacity	ml	4 - 5,5	7,5 - 8,2	9 - 10	3,2 - 4	15
Maße / dimensions	∅ x L mm	15,3 x 75	15,3 x 92	16,5 x 92	15,3 x 57	17 x 120
Anzahl p. Gestell/number p. frame		12	12	12	12	6
Anzahl p. Rotor / number p. rotor		48	48	48	48	24
Drehzahl / speed	RPM	5000	5000	5000	5000	5000
RZB / RCF		4388	4388	4388	3550	4388
Radius / radius	mm	157	157	157	127	157
 9 (97%)	sec	16	16	16	16	16
 9	sec	19	19	19	19	19
 0	sec	232	232	232	232	232
Temperatur / temperature	°C ¹⁾	- 10	- 10	- 10	- 10	- 10





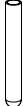





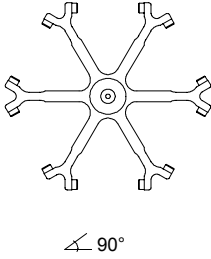

1794		1790								
Ausschwingrotor 4-fach / Swing out rotor 4-times 										
		Reduzierung / adapter								
		5126	5125	1793	5124	5122	5133	5121	5120	
		Röhrchen / tube								
		0523	0526	0513	0521	0519	0509	0507	0578	
										
Kapazität / capacity	ml	100	80	50	50	25	15	15	7	
Maße / dimensions	∅ x L	mm	40 x 115	44 x 100	30 x 115	34 x 100	24 x 100	17 x 120	17 x 100	12 x 100
Anzahl p. Gestell/number p. frame		1	1	2	1	4	4	7	12	
Anzahl p. Rotor / number p. rotor		4	4	8	4	16	16	28	48	
Drehzahl / speed	RPM	4000	4000	4000	4000	4000	4000	4000	4000	
RZB / RCF		2665	2665	2808	2683	2647	2808	2719	2719	
Radius / radius	mm	149	149	157	150	148	157	152	152	
 9 (97%)	sec	16	16	16	16	16	16	16	16	
 9	sec	20	20	20	20	20	20	20	20	
 0	sec	246	246	246	246	246	246	246	246	
Temperatur / temperature	°C ¹⁾	- 8	- 8	- 8	- 8	- 8	- 8	- 8	- 8	

1794		1790								
Ausschwingrotor 4-fach / Swing out rotor 4-times 										
		Reduzierung / adapter								
		5128	6319 ohne Gummi / without rubber							
		Röhrchen / tube								
			5127	0530 / 1791 Einlage / Insert						
										
Kapazität / capacity	ml	6	250	250						
Maße / dimensions	∅ x L	mm	12 x 82	62 x 122		65 x 115				
Anzahl p. Gestell/number p. frame		12	1	1						
Anzahl p. Rotor / number p. rotor		48	4	4						
Drehzahl / speed	RPM	4000	4000	4000						
RZB / RCF		2719	2808	2808						
Radius / radius	mm	152	157	157						
 9 (97%)	sec	16	16	16						
 9	sec	20	20	20						
 0	sec	246	246	246						
Temperatur / temperature	°C ¹⁾	- 8	- 8	- 8						

1) Tiefste erreichbare Temperatur bei maximaler Drehzahl und 1 Stunde Laufzeit (nur bei Kühlzentrifuge)











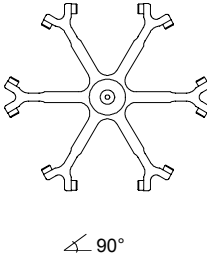

1) Lowest possible temperature during maximum speed and 1 hour running time (only with cooling centrifuges)





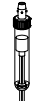



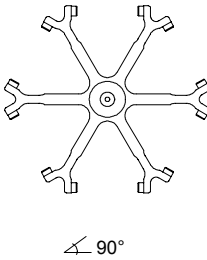

1726		1345	1346	1366			1369	1370		
Ausschwingrotor 6-fach / Swing out rotor 6-times 		Reduzierung / adapter								
				1327	1326	1357	5277			
		Röhrchen / tube								
						Rhesus	2078	0536	0507	0500
										
Kapazität / capacity	ml	45	20	3	4	1	1,5	2,0	15	9
Maße / dimensions	Ø x L	mm	31 x 100	21 x 100	10 x 60	12 x 60	6 x 45	11 38	17 x 100	14 x 100
Anzahl p. Gestell / number p. frame		1	2	12	12	30	9	4	5	
Anzahl p. Rotor / number p. rotor		6	12	72	72	180	54	24	30	
Drehzahl / speed	RPM	4000	4000	4000	4000	4000	4000	4000	4000	
RZB / RCF		2719	2719	2290	2290	2308	2308	2701	2701	
Radius / radius	mm	152	152	128	128	129	129	151	141	
 9 (97%)	sec	16	16	16	16	16	16	16	16	
 9	sec	20	20	20	20	20	20	20	20	
 0	sec	210	210	210	210	210	210	210	210	
Temperatur / temperature	°C ¹⁾	- 13	- 13	- 10	- 10	- 10	- 10	- 10	- 13	

1726		1372	1741						
Ausschwingrotor 6-fach / Swing out rotor 6-times 									
		Reduzierung / adapter							
			0701 Gummi- einlage / Rubber inlay	0701 Gummi- einlage / Rubber inlay	---	---		0701 Gummi- einlage / Rubber inlay	
		Röhrchen / tube							
			Sarstedt	Sarstedt	Sarstedt	Sarstedt	Vacutainer		
									
Kapazität / capacity	ml	5	9	1,1 – 1,4	4	4,5 – 5	4,9	4 – 7 ml	
Maße / dimensions	Ø x L	mm	12 x 75	14 x 100	8,5 x 66	11,5 x 84	11,5 x 92	13 x 90	13 x 100
Anzahl p. Gestell / number p. frame		17	10	10	10	6	10	6	
Anzahl p. Rotor / number p. rotor		102	60	60	60	36	60	36	
Drehzahl / speed	RPM	4000	4000	4000	4000	4000	4000	4000	
RZB / RCF		2522	2733	2773	2808	2808	2808	2773	
Radius / radius	mm	141	155	155	157	157	157	155	
 9 (97%)	sec	16	16	16	16	16	16	16	
 9	sec	20	20	20	20	20	20	20	
 0	sec	210	210	210	210	210	210	210	
Temperatur / temperature	°C ¹⁾	- 10	- 9	- 9	- 9	- 9	- 9	- 9	

1) Tiefste erreichbare Temperatur bei maximaler Drehzahl und 1 Stunde Laufzeit (nur bei Kühlzentrifuge)

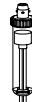
1) Lowest possible temperature during maximum speed and 1 hour running time (only with cooling centrifuges)

1726		1742							
Ausschwingrotor 6-fach / Swing out rotor 6-times  $\sphericalangle 90^\circ$									
		Reduzierung / adapter							
		---	0716 Gummieinlage / Rubber inlay		---	1743	---	1744	
		Röhrchen / tube							
	0507	Vacutainer	Vacutainer	Vacutainer	Sarstedt	Sarstedt	Sarstedt		
									
Kapazität / capacity	ml	15	1,6 - 5	4 - 7	8,5 - 10	3,2 - 4	2,6 - 2,9	4 - 5,5	
Maße / dimensions	Ø x L	mm	17 x 100	13 x 75	16 x 75	16 x 100	15,3 x 57	13 x 65	15,3 x 75
Anzahl p. Gestell/number p. frame		7	7	7	7	7	7	7	
Anzahl p. Rotor / number p. rotor		42	42	42	42	42	42	42	
Drehzahl / speed	RPM	4000	4000	4000	4000	4000	4000	4000	
RZB / RCF		2808	2683	2683	2808	2254	2808	2576	
Radius / radius	mm	157	150	150	157	126	157	144	
 9 (97%)	sec	16	16	16	16	16	16	16	
 9	sec	20	20	20	20	20	20	20	
 0	sec	210	210	210	210	210	210	210	
Temperatur / temperature	°C ¹⁾	-9	-9	-9	-9	-9	-9	-9	









1726		1742		1745		1746			
Ausschwingrotor 6-fach / Swing out rotor 6-times  $\sphericalangle 90^\circ$									
		Reduzierung / adapter							
		---	---	---	---	---	---		
		Röhrchen / tube							
	Sarstedt	Sarstedt	0509		Sarstedt				
									
Kapazität / capacity	ml	7,5 - 8,2	9 - 10	15	25	25	50		
Maße / dimensions	Ø x L	mm	15,3 x 92	16,5 x 92	17 x 120	24 x 100	25 x 92	34 x 100	
Anzahl p. Gestell/number p. frame		7	7	3 *)	2	2	1		
Anzahl p. Rotor / number p. rotor		42	42	18	12	12	6		
Drehzahl / speed	RPM	4000	4000	4000	4000	4000	4000		
RZB / RCF		2808	2808	2808	2808	2808	2808		
Radius / radius	mm	157	157	157	157	157	157		
 9 (97%)	sec	16	16	16	16	16	16		
 9	sec	20	20	20	20	20	20		
 0	sec	210	210	210	210	210	210		
Temperatur / temperature	°C ¹⁾	-9	-9	-9	-9	-9	-9		

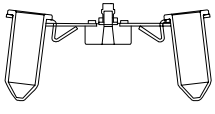

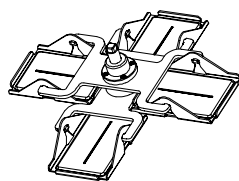

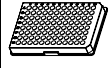
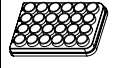





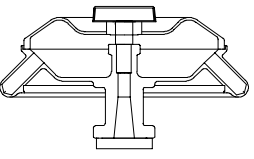

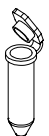

1) Tiefste erreichbare Temperatur bei maximaler Drehzahl und 1 Stunde Laufzeit (nur bei Kühlzentrifuge)

*) im Gehänge nur die mittlere Reihe belegen

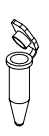
1) Lowest possible temperature during maximum speed and 1 hour running time (only with cooling centrifuges)

*) in the middle

1717				1725		4325	
Ausschwingrotor 10-fach / Swing out rotor 10-times  		Reduzierung / adapter		Ausschwingrotor 4-fach / Swing out rotor 4-times  		Mikrotiterplatte / Microtiter-plates	
		1462					
		Röhrchen / tube				Kultuplatte / Culture-plates	
		0513	0509				
Kapazität / capacity ml		50	15				
Maße / dimensions Ø x L mm		29 x 115					
Anzahl p. Gestell/number p. frame						1	
Anzahl p. Rotor / number p. rotor		10				4	
Drehzahl / speed RPM		5000				4000	
RZB / RCF		4556				2147	
Radius / radius mm		163				120	
 9 (97%) sec		15				16	
 9 sec		19				18	
 0 sec		206				182	
Temperatur / temperature °C ¹⁾		- 6				- 16	

1714											
Winkelrotor 30-fach / Angle rotor 30-times 		Reduzierung / adapter									
		---	2031	2023	2023	2024	2024				
		    									
		Röhrchen / tube									
2078	0536	---	---	---	---						
     											
Kapazität / capacity ml		1,5	2,0	0,8	0,5	0,4	0,2				
Maße / dimensions Ø x L mm		11 x 38	11 x 38	8 x 45	8 x 30	6 x 45	6 x 18				
Anzahl p. Gestell/number p. frame		---									
Anzahl p. Rotor / number p. rotor		30									
Drehzahl / speed RPM		15000									
RZB / RCF		23646									
Radius / radius mm		94									
 9 (97%) sec		15									
 9 sec		15									
 0 sec		241									
Temperatur / temperature °C ¹⁾		0									

1) Tiefste erreichbare Temperatur bei maximaler Drehzahl und 1 Stunde Laufzeit (nur bei Kühlzentrifuge)



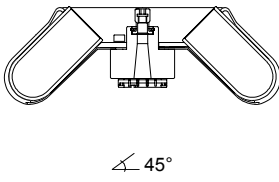
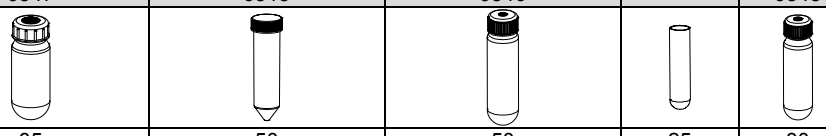

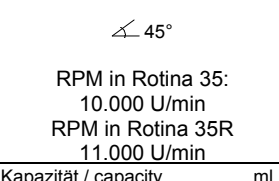
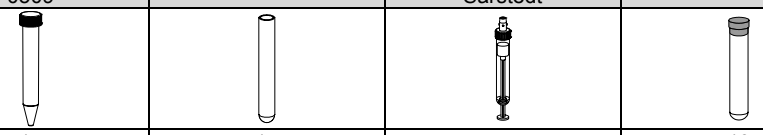
1) Lowest possible temperature during maximum speed and 1 hour running time (only with cooling centrifuges)





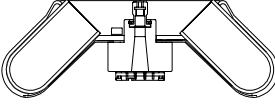
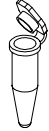
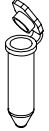

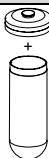

1720																	
Winkelrotor 6-fach / Angle rotor 6-times																	
										Reduzierung / adapter							
 $\angle 45^\circ$ RPM in Rotina 35: 10.000 U/min RPM in Rotina 35R: 11.000 U/min										---		1454		1446		1447	
										Röhrchen / tube							
										0547		0513		0546		0545	
										Kapazität / capacity ml		85		50		50	
Maße / dimensions \varnothing x L mm		38 x 106		29 x 115		29 x 107		24 x 100		26 x 95							
Anzahl p. Gestell/number p. frame				1		1		1									
Anzahl p. Rotor / number p. rotor		6		6		6		6		6							
Drehzahl / speed RPM		10000		11000		10000		11000		10000		11000					
RZB / RCF		13416		16233		13081		15828		12857		15557		12298		14881	
Radius / radius mm		120		117		115		110									
9 (97%) sec		56		58		56		58		56		58					
9 sec		57		58		57		58		57		58					
0 sec		780		960		780		960		780		960					
Temperatur / temperature $^\circ\text{C}^{1)}$		- 1		- 1		- 1		- 1		- 1		- 1					

1720																	
Winkelrotor 6-fach / Angle rotor 6-times																	
										Reduzierung / adapter							
 $\angle 45^\circ$ RPM in Rotina 35: 10.000 U/min RPM in Rotina 35R: 11.000 U/min										1466		1451				1448	
										Röhrchen / tube							
										0509				Sarstedt			
										Kapazität / capacity ml		15		15		7,5	
Maße / dimensions \varnothing x L mm		17 x 120		17 x 100		15,3 / 16,5 x 92		16 x 80									
Anzahl p. Gestell/number p. frame		1		1		1		2									
Anzahl p. Rotor / number p. rotor		6		6		6		12									
Drehzahl / speed RPM		10000		11000		10000		11000		10000		11000					
RZB / RCF		12857		15557		12633		15286		12633		15286					
Radius / radius mm		115		113		113		113									
9 (97%) sec		56		58		56		58		56		58					
9 sec		57		58		57		58		57		58					
0 sec		780		960		780		960		780		960					
Temperatur / temperature $^\circ\text{C}^{1)}$		- 1		- 1		- 1		- 1		- 1		- 1					

1) Tiefste erreichbare Temperatur bei maximaler Drehzahl und 1 Stunde Laufzeit (nur bei Kühlzentrifuge)

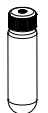







1) Lowest possible temperature during maximum speed and 1 hour running time (only with cooling centrifuges)

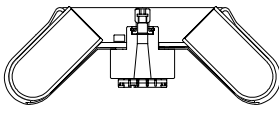





1720									
Winkelrotor 6-fach / Angle rotor 6-times  $\angle 45^\circ$ RPM in Rotina 35: 10.000 U/min RPM in Rotina 35R: 11.000 U/min		Reduzierung / adapter							
		1449							
		Röhrchen / tube							
		2078 	0536 						
Kapazität / capacity	ml	1,5	2,0						
Maße / dimensions	Ø x L	11 x 38							
Anzahl p. Gestell / number p. frame		4							
Anzahl p. Rotor / number p. rotor		24							
Drehzahl / speed	RPM	10000	11000						
RZB / RCF		12857	15557						
Radius / radius	mm	115							
 9 (97%)	sec	56	58						
 9	sec	57	58						
 0	sec	780	960						
Temperatur / temperature	°C ¹⁾	- 1							

1792									
Winkelrotor 6-fach / Angle rotor 6-times  $\angle 45^\circ$ RPM in Rotina 35: 10.000 U/min RPM in Rotina 35R: 11.000 U/min		Reduzierung / adapter							
		---		---		1454		1446	
		Röhrchen / tube							
		0539 /0538 	0549 	0547 		0513 		0546 	
Kapazität / capacity	ml	94		85		50		50	
Maße / dimensions	Ø x L	38 x 106		38 x 106		29 x 115		29 x 107	
Anzahl p. Gestell / number p. frame		---		---		1		1	
Anzahl p. Rotor / number p. rotor		6		6		6		6	
Drehzahl / speed	RPM	10000	11000	10000	11000	10000	11000	10000	11000
RZB / RCF		13640	16504	13640	16504	13304	16098	13081	15828
Radius / radius	mm	122		122		119		117	
 9 (97%)	sec	53	56	53	56	53	56	53	56
 9	sec	53	56	53	56	53	56	53	56
 0	sec	930	1040	930	1040	930	1040	930	1040
Temperatur / temperature	°C ¹⁾	1		1		1		1	

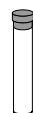
1) Tiefste erreichbare Temperatur bei maximaler Drehzahl und 1 Stunde Laufzeit (nur bei Kühlzentrifuge)











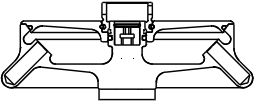



1) Lowest possible temperature during maximum speed and 1 hour running time (only with cooling centrifuges)



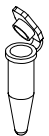



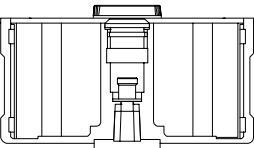

1792																			
<p>Winkelrotor 6-fach / Angle rotor 6-times</p>  <p>∠ 45°</p> <p>RPM in Rotina 35: 10.000 U/min RPM in Rotina 35R 11.000 U/min</p>										Reduzierung / adapter									
										1447		1466		1451		1451			
										Röhrchen / tube									
										0545		0509				Sarstedt			
																			
Kapazität / capacity	ml	25 / 30		15		15		7,5											
Maße / dimensions	∅ x L mm	24 x 100 / 26 x 95		17 x 120		17 x 100		15,3 / 16,5 x 92											
Anzahl p. Gestell/number p. frame		1		1		1													
Anzahl p. Rotor / number p. rotor		6		6		6													
Drehzahl / speed	RPM	10000	11000	10000	11000	10000	11000	10000	11000										
RZB / RCF		12522	15151	13081	15828	12857	15557	12857	15557										
Radius / radius	mm	112		117		115		115											
 9 (97%)	sec	53	56	53	56	53	56	53	56										
 9	sec	53	56	53	56	53	56	53	56										
 0	sec	930	1040	930	1040	930	1040	930	1040										
Temperatur / temperature	°C ¹⁾	1		1		1		1											

1792																			
<p>Winkelrotor 6-fach / Angle rotor 6-times</p>  <p>∠ 45°</p> <p>RPM in Rotina 35: 10.000 U/min RPM in Rotina 35R 11.000 U/min</p>										Reduzierung / adapter									
										1448		1449							
										Röhrchen / tube									
												2078		0536					
																			
Kapazität / capacity	ml	10		1,5		2,0													
Maße / dimensions	∅ x L mm	16 x 80		11 x 38															
Anzahl p. Gestell/number p. frame		2		4															
Anzahl p. Rotor / number p. rotor		12		24															
Drehzahl / speed	RPM	10000	11000	10000	11000														
RZB / RCF		12857	15557	13081	15828														
Radius / radius	mm	115		117															
 9 (97%)	sec	53	56	53	58														
 9	sec	53	56	53	56														
 0	sec	930	1040	930	1040														
Temperatur / temperature	°C ¹⁾	1		1															

1) Tiefste erreichbare Temperatur bei maximaler Drehzahl und 1 Stunde Laufzeit (nur bei Kühlzentrifuge)







1) Lowest possible temperature during maximum speed and 1 hour running time (only with cooling centrifuges)

1789								
Winkelrotor 30-fach / Angle rotor 30-times   45° aerosoldicht / aerosol-proof		Reduzierung / adapter						
		---	2031	2023	2023	2024	2024	
								
		Röhrchen / tube						
		---	2078	---	---	---		
								
Kapazität / capacity	ml	2,0	1,5	0,8	0,5	0,4	0,2	
Maße / dimensions	∅ x L mm	11 x 38	11 x 38	8 x 45	8 x 45	6 x 45	6 x 18	
Anzahl p. Gestell/number p. frame								
Anzahl p. Rotor / number p. rotor		30	30	30	30	30	30	
Drehzahl / speed	RPM	15000	15000	15000	15000	15000	15000	
RZB / RCF		24400	24400	24000	24000	24000	24000	
Radius / radius	mm	97	97	97	97	97	97	
 9 (97%)	sec	25	25	25	25	25	25	
 9	sec	28	28	28	28	28	28	
 0	sec	455	455	455	455	455	455	
Temperatur / temperature	°C ¹⁾							

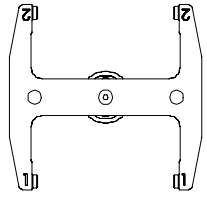
1711		1377		1379		1378	
Topfrotor 6-fach / Pot rotor 6-times  RPM in Rotina 35: 12.000 U/min RPM in Rotina 35R 14.000 U/min		Reduzierung / adapter					
		Röhrchen / tube					
		2078	0536				
							
Kapazität / capacity	ml	1,5	2,0	0,5	0,8	0,4	
Maße / dimensions	∅ x L mm	11 x 38		8 x 30	8 x 45	6 x 45	
Anzahl p. Gestell/number p. frame		10		21	21	32	
Anzahl p. Rotor / number p. rotor		60		126	126	192	
Drehzahl / speed	RPM	12000	14000	12000	14000	12000	14000
RZB / RCF		12075	16435	12075	16435	12075	16435
Radius / radius	mm	75		75	75	75	
 9 (97%)	sec	16	25	16	25	16	25
 9	sec	18	28	18	28	18	28
 0	sec	355	402	355	402	355	402
Temperatur / temperature	°C ¹⁾	- 2		- 2	- 2	- 2	

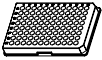
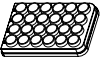
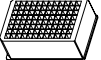
1) Tiefste erreichbare Temperatur bei maximaler Drehzahl und 1 Stunde Laufzeit (nur bei Kühlzentrifuge)











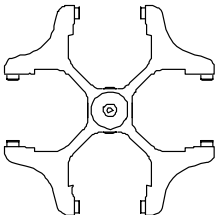

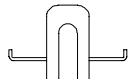



1) Lowest possible temperature during maximum speed and 1 hour running time (only with cooling centrifuges)

1713		1735		
Ausschwingrotor 2-fach / Swing out rotor 2-times				
				
				
		Microtiterplatten/ Microtiter-plates	Kulturplatten / Culture plates	Deepwellplatten/ Deepwell plates
				
Kapazität / capacity	ml			
Maße / dimensions	Ø x L	mm		
Anzahl p. Gestell/number p. frame		4	2	1
Anzahl p. Rotor / number p. rotor		8	4	2
Drehzahl / speed	RPM	4000	4000	4000
RZB / RCF		1968	1968	1968
Radius / radius	mm	110	110	110
 9 (97%)	sec	17	17	17
 9	sec	31	31	31
 0	sec	430	430	430
Temperatur / temperature	°C ¹⁾	- 15	- 15	- 15











Standard-Zentrifugiergefäße aus Glas sind belastbar bis RZB 4000 (DIN 58970 Teil 2) /

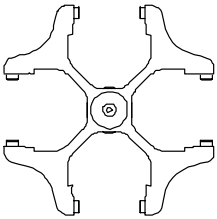

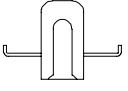



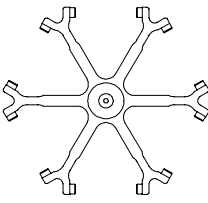

Standard centrifuge containers of glass will not stand RCF values exceeding 4000 (DIN 58970 pg. 2)

1724		1452							
Ausschwingrotor 4-fach / Swing out rotor 4-times									
									
		Spannplatte / slide carrier							
						 ²⁾			
		Zyto-Kammer / cyto chamber							
		1663	1664	1665	1666	1667	1668	1663	1664
									
Kapazität / capacity	ml	1	2	4	8	3 x 2	4 x 1	1	2
Maße / dimensions	Ø / A	mm ²	6,2 / 30	8,7 / 60	12,4 / 120	17,5 / 240	8,7 / 60	6,2 / 30	8,7 / 60
Anzahl p. Gestell/number p. frame		1	1	1	1	1	1	2	2
Anzahl p. Rotor / number p. rotor		4	4	4	4	4	4	8	8
Filterkarten / filter cards		1675	1675	1675	1676	1677	1678	1692	1692
Drehzahl / speed	RPM	5000	5000	5000	5000	5000	5000	5000	5000
RZB / RCF		3186	3186	3186	3186	3186	3186	3186	3186
Radius / radius	mm	114	114	114	114	114	114	114	114
 9 (97%)	sec	16	16	16	16	16	16	16	16
 9	sec	19	19	19	19	19	19	19	19
 0	sec	232	232	232	232	232	232	232	232
Temperatur / temperature	°C ¹⁾	- 17	- 17	- 17	- 17	- 17	- 17	- 17	- 17

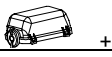
1) Tiefste erreichbare Temperatur bei maximaler Drehzahl und 1 Stunde Laufzeit (nur bei Kühlzentrifuge)
 2) Objektträger nur belastbar bis RZB 1100

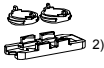









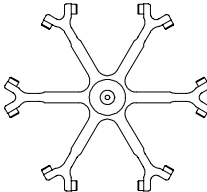

1) Lowest possible temperature during maximum speed and 1 hour running time (only with cooling centrifuges)
 2) Object carrier will not stand RCF values exceeding 1100











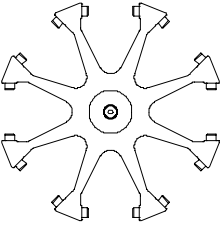





1724		1452									
Ausschwingrotor 4-fach / Swing out rotor 4-times  											
		aerosoldicht / aerosol-proof									
		Spannplatte / slide carrier									
		1670  2)				1285  ohne Deckel / without lid 1661					
		Zyto-Kammer / cyto chamber									
		1665	1666	1667	1668						
Kapazität / capacity	ml	4	8	3 x 2	4 x 1						
Maße / dimensions	Ø / A mm ²	12,4 / 120	17,5 / 240	8,7 / 60	6,2 / 30						
Anzahl p. Gestell / number p. frame		2	2	2	2	6					
Anzahl p. Rotor / number p. rotor		8	8	8	8	24					
Filterkarten / filter cards		1692	1691	1694	1693						
Drehzahl / speed	RPM	5000	5000	5000	5000	5000					
RZB / RCF		3186	3186	3186	3186						
Radius / radius	mm	114	114	114	114						
 9 (97%)	sec	16	16	16	16	16					
 9	sec	19	19	19	19						
 0	sec	232	232	232	232						
Temperatur / temperature	°C ¹⁾	- 17	- 17	- 17	- 17						

1726		1661				1660			
Ausschwingrotor 6-fach / Swing out rotor 6-times  		 +							
		Spannplatte / slide carrier							
		1662 				1670  2)			
		Zyto-Kammer / cyto chamber							
				1663	1664	1665	1666	1667	1668
Kapazität / capacity	ml	1	2	4	8	3 x 2	4 x 1	1	2
Maße / dimensions	Ø / A mm ²	6,2 / 30	8,7 / 60	12,4 / 120	17,5 / 240	8,7 / 60	6,2 / 30	6,2 / 30	8,7 / 60
Anzahl p. Gestell / number p. frame		1	1	1	1	1	1	2	2
Anzahl p. Rotor / number p. rotor		6	6	6	6	6	6	12	12
Filterkarten / filter cards		1675	1675	1675	1676	1677	1678	1692	1692
Drehzahl / speed	RPM	4000	4000	4000	4000	4000	4000	4000	4000
RZB / RCF		1986	1986	1986	1986	1986	1986	1986	1986
Radius / radius	mm	111	111	111	111	111	111	111	111
 9 (97%)	sec	16	16	16	16	16	16	16	16
 9	sec	20	20	20	20	20	20	20	20
 0	sec	210	210	210	210	210	210	210	210
Temperatur / temperature	°C ¹⁾	- 13	- 13	- 13	- 13	- 13	- 13	- 13	- 13

- 1) Tiefste erreichbare Temperatur bei maximaler Drehzahl und 1 Stunde Laufzeit (nur bei Kühlzentrifuge)
- 2) Objektträger nur belastbar bis RZB 1100









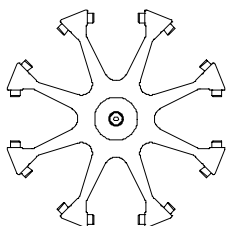

- 1) Lowest possible temperature during maximum speed and 1 hour running time (only with cooling centrifuges)
- 2) Object carrier will not stand RCF values exceeding 1100

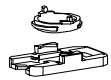
1726		1661 1660				1660	1680		
Ausschwingrotor 4-fach / Swing out rotor 4-times  ↙ 90°		 +							
									Spannplatte / slide carrier
		1670  2)				1285 		1662	
		Zyto-Kammer / cyto chamber							
		1665	1666	1667	1668		1671	1672	1673
									
Kapazität / capacity	ml	4	8	3 x 2	4 x 1	Objektträger	[1] 0,5	[1] 0,5	[1] 0,5
Maße / dimensions Ø / A	mm ²	12,4 / 120	17,5 / 240	8,7 / 60	6,2 / 30	26 / 76	6,2 / 30	8,7 / 60	12,4 / 120
Anzahl p. Gestell/number p. frame		2	2	2	2	6	1	1	1
Anzahl p. Rotor / number p. rotor		12	12	12	12	36	6	6	6
Filterkarten / filter cards		1692	1691	1694	1693		[1] 1696	[1] 1696	[1] 1696
Drehzahl / speed	RPM	4000	4000	4000	4000	4000	4000	4000	4000
RZB / RCF		1986	1986	1986	1986		1986	1986	1986
Radius / radius	mm	111	111	111	111		101	101	101
 9 (97%)	sec	16	16	16	16		16	16	16
 9	sec	20	20	20	20		20	20	20
 0	sec	210	210	210	210		210	210	210
Temperatur / temperature	°C ¹⁾	- 13	- 13	- 13	- 13		-13	-13	-13

1748		1661 1660							
Ausschwingrotor 8-fach / Swing out rotor 8-times 		 + 							
		1662 				1670  2)			
		Zyto-Kammer / cyto chamber							
		1663	1664	1665	1666	1667	1668	1663	1664
									
Kapazität / capacity	ml	1675	1675	1675	1676	1677	1678	1692	1692
Maße / dimensions Ø / A	mm ²	1	2	4	8	3 x 2	4 x 1	1	2
Anzahl p. Gestell/number p. frame		6,2 / 30	8,7 / 60	12,4 / 120	17,5 / 240	8,7 / 60	6,2 / 30	6,2 / 30	8,7 / 60
Anzahl p. Rotor / number p. rotor		1	1	1	1	1	1	2	2
Filterkarten / filter cards		8	8	8	8	8	8	16	16
Drehzahl / speed	RPM	4000	4000	4000	4000	4000	4000	4000	4000
RZB / RCF		2397	2397	2397	2397	2397	2397	2397	2397
Radius / radius	mm	134	134	134	134	134	134	134	134
 9 (97%)	sec	16	16	16	16	16	16	16	16
 9	sec	20	20	20	20	20	20	20	20
 0	sec	210	210	210	210	210	210	210	210
Temperatur / temperature	°C ¹⁾	- 13	- 13	- 13	- 13	- 13	- 13	- 13	- 13

1) Tiefste erreichbare Temperatur bei maximaler Drehzahl und 1 Stunde Laufzeit (nur bei Kühlzentrifuge)
 2) Objektträger nur belastbar bis RZB 1100
 [1] Einschritt-Methode

1) Lowest possible temperature during maximum speed and 1 hour running time (only with cooling centrifuges)
 2) Object carrier will not stand RCF values exceeding 1100
 [1] One-step methode

1748		1661		1660		1660		1680			
Ausschwingrotor 8-fach / Swing out rotor 8-times 				+							
		Spannplatte / slide carrier									
		1670				1285		1662			
											
		Zyto-Kammer / cyto chamber									
		1665	1666	1667	1668			1671	1672	1673	
											
Kapazität / capacity	ml	4	8	3 x 2	4 x 1	Objekträger	[1] 0,5	[1] 0,5	[1] 0,5		
Maße / dimensions	Ø / A mm ²	12,4 / 120	17,5 / 240	8,7 / 60	6,2 / 30	26 / 76	6,2 / 30	8,7 / 60	12,4 / 120		
Anzahl p. Gestell / number p. frame		2	2	2	2	6	1	1	1		
Anzahl p. Rotor / number p. rotor		16	16	16	16	48	8	8	8		
Filterkarten / filter cards		1692	1691	1694	1693		[1] 1696	[1] 1696	[1] 1696		
Drehzahl / speed	RPM	4000	4000	4000	4000		4000	4000	4000		
RZB / RCF		2397	2397	2397	2397		2218	2218	2218		
Radius / radius	mm	134	134	134	134		124	124	124		
 9 (97%)	sec	16	16	16	16		16	16	16		
 9	sec	20	20	20	20		20	20	20		
 0	sec	210	210	210	210		210	210	210		
Temperatur / temperature	°C ¹⁾	- 13	- 13	- 13	- 13		-13	-13	-13		

1) Tiefste erreichbare Temperatur bei maximaler Drehzahl und 1 Stunde Laufzeit (nur bei Kühlzentrifuge)

2) Objekträger nur belastbar bis RZB 1100

[1] Einschritt-Methode

1) Lowest possible temperature during maximum speed and 1 hour running time (only with cooling centrifuges)

2) Object carrier will not stand RCF values exceeding 1100

[1] One-step methode

Technische Änderungen vorbehalten! / Technical alterations reserved!