

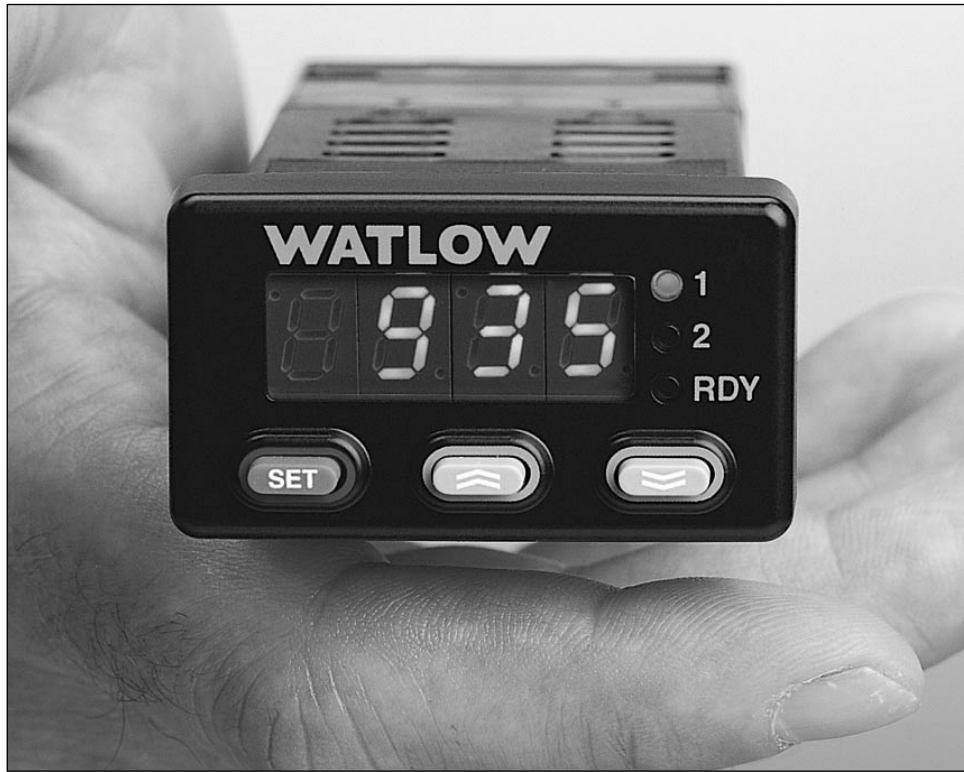

Series 935A

User's Manual



Temperature Controller with Countdown Timer



U.S. English

1241 Bundy Boulevard, P.O. Box 5580, Winona, Minnesota USA 55987-5580
Phone: +1 (507) 454-5300, Fax: +1 (507) 452-4507, <http://www.watlow.com>

0600-0015-0000 Rev L
January 2002
Supersedes: 0600-0015-0000 Rev K

\$15.00



Safety Alert
CAUTION or
WARNING

Safety Information in this Manual

Note, caution and warning symbols appear throughout this book to draw your attention to important operational and safety information.

A “NOTE” marks a short message to alert you to an important detail.

A “CAUTION” safety alert appears with information that is important for protecting your equipment and performance.

A “WARNING” safety alert appears with information that is important for protecting you, others and equipment from damage. Pay very close attention to all warnings that apply to your application.

The  symbol (an exclamation point in a triangle) precedes a general CAUTION or WARNING statement.

The  symbol (a lightning bolt in a lightning bolt in a triangle) precedes an electric shock hazard CAUTION or WARNING safety statement.



Electrical Shock
Hazard

CAUTION or
WARNING

Technical Assistance

If you encounter a problem with your Watlow controller, review all configuration information to verify that your selections are consistent with your application: inputs; outputs; alarms; limits; etc. If the problem persists after checking the above, you can get technical assistance by calling your local Watlow representative (see back cover of this manual), or in the U.S., dial +1 (507) 454-5300. For technical support, ask for an Applications Engineer.

Please have the following information available when you call:

- Complete model number
- All configuration information
- User’s Manual
- Diagnostic menu readings

Warranty and return information is on the inside back cover of this manual.

Your Comments

Your comments or suggestions on this manual are welcome. Please send them to the Technical Literature Team, Watlow Winona, 1241 Bundy Boulevard, P.O. Box 5580, Winona, Minnesota, 55987-5580 U.S.; Telephone: +1 (507) 454-5300; fax: +1 (507) 452-4507.

Copyright January 2002 by Watlow Winona, Inc., with all rights reserved. (2190)



Where to find it...

Table of Contents

Item	Page
Introduction	2
How Keys Work	4
Begin Controlling	6
Set Point Change	7
Simple Error / Response	8
Software Map; Learn	9
Operations Menu; Learn	10
PID Menu; Learn	12
Configuration Menu; Learn	16
Lockout Functions	18
Setting Up Inputs and Outputs	20
Remote Set Point	22
Front Panel Lockout	23
Alarms; Learn	24
Alarms; Setting and Clearing	26
Timer; Learn	28
Timer; Setting	30
Timer Example	31
Auto-tuning	32
PID Fine tuning	33
Calibrating	34
Errors and Troubleshooting	36
Mounting	38
Dimensions	39
Installing	40
Terminal Block Removal	41
Wiring	42
Wiring Examples	44
Glossary	46
Index	48
Specifications	50
Ordering Information	51
Declaration of Conformity	52
Software Map	55
How to Reach Us	back cover

Table Numbers

Table Numbers	Page
1 Output Functions	3
2 Error Messages and Action	8
3 Software Organization	9
4 Operations Menu Overview	11
5 PID Menu Overview	14
6 Configuration Overview	16
7 Lockout Options	19
8 Setting Inputs and Outputs	21
9 Using Front Panel Lock	23
10 Alarm Functions	25
11 More Alarm Functions	27
12 Timer Functions/Settings	29
13 Error Codes and Actions	37
14 Troubleshoot Outputs	37
15 Input Range Information	51

Figure Numbers

Figure Numbers	Page
1 Input and Output Overview	3
2 Front Panel Functions	5
3 Begin Controlling	6
4 Changing the Set Point	7
5 Remote Set Point Wiring	22
6 Front Panel Lock Wiring	23
7 Auto-tuning	32
8 Calibrating	34
9 Panel Cut-out Dimensions	38
10 Knockout Template	38
11 Dimensions	39
12 Case Top View and Collar	40
13 NEMA 4X/IP65 Seal	40
14 Terminal Block Removal	41
15 Wiring	42
16 System Wiring Example	44
17 Ladder Diagram Example	45



Introduction

Welcome to the Watlow Series 935A!

General Description

The Series 935A is a temperature controller with countdown timer for industrial, commercial, or scientific applications. It offers 1/32 DIN panel-mounting, digital indication, single temperature sensor input from a thermocouple or RTD, and dual control outputs. Outputs may operate in combinations of heat or cool, and alarm or timer.

Special Features

- Easy to use operator interface and user's manual
- Compact panel footprint; 1/32 DIN size
- Water and corrosion proof; IP65/NEMA 4X rated
- Reliable; built to UL, CUL approved safety standards with a three year warranty
- Accuracy with economy
- Universal power supply for worldwide application

Unique Features

The Series 935A Output 1 can be configured as a remote set point input for a multi-loop control system, or, as an alternative, that output can be a front panel lock with your switch to further reinforce the 935A's lockout capability. The Series 935A timer functions include heat/timer or cool/timer countdown modes in hours:minutes or minutes:seconds.

Figure 1 - Series 935A Input and Output Overview



Single Input

Type J, K, T, N, S, E Thermocouple, 1° RTD, or 0.1° RTD

Output 1

Switched dc

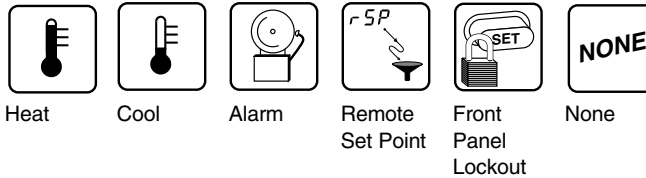

Output 2

Electromechanical Relay, Switched dc or Solid-state Relay

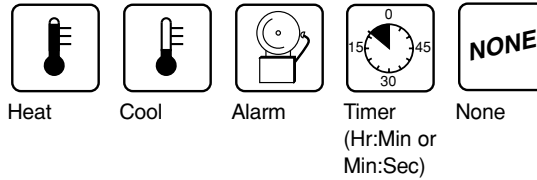

- The function of Output 1 determines the options available for Output 2.
- First select the function of Output 1. Refer to the table (right), then select the function of Output 2.

Table 1 - Valid Output Functions

First select Output 1:	Then select Output 2:
Heat	None, Cool, Alarm, Timer
Cool	None, Heat, Alarm, Timer
Alarm	None, Heat, Cool
Remote Set Point	Heat, Cool
Front Panel Lock	Heat, Cool, Alarm
None	Heat, Cool, Alarm



Read or change





You can simply:

- Read the normally displayed actual temperature,

or...

- Press and hold **SET** to read the set point,

or...

1. Press and hold  and  simultaneously for three seconds to move to a software menu.
2. Press and hold **SET** to display a choice or value.
3. While continuing to press **SET**, press  or  to choose new data or select a new value.
4. Release **SET** and the arrow key to complete the change.

NOTE: The normally displayed actual temperature and set point can be altered to show different combinations of actual temperature, set point temperature, or time in hours:minutes or minutes:seconds. See **dISP** p. 16.

Figure 2 - Series 935A Front Panel Functions

Seven-segment alphanumeric display:

- Shows process value, set point information, time, or
- Shows prompt name or value, depending on the key combination pressed.

Set Key: SET

- Configurable to shift between normally-displayed value and set values. See **DISP**, p.16.
- Clears a latched alarm.

LED 1:



Lit when Output 1 is active.

LED 2:

Lit when Output 2 is active.

RDY:

Lit when the process temperature is inside the timer ready band.

**Up /  (Increment)
Down /  (Decrement) Arrow Key:**

- Selects new information when Set Key is pressed.
- Steps through software menus and parameters.
- Starts and stops the timer.

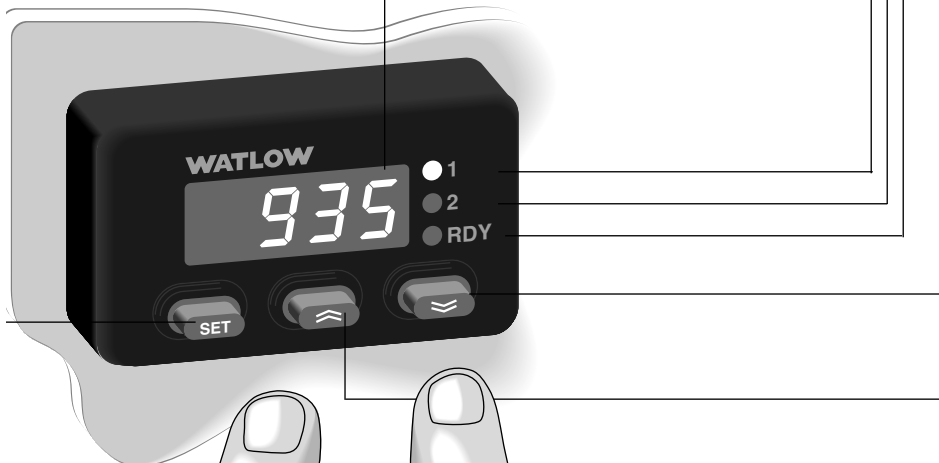

- To set up the control, go to the Easy Software Map, p. 9.



Begin Controlling

1. Apply power to the system.

A properly-wired Series 935A will begin controlling the thermal system as soon as you apply power to it.

2. Look at the Series 935A's display. It is reading actual temperature, set point temperature, or time.

- To change set point, go to p. 7.
- The Series 935A will auto-tune when you tell it to, go to p. 32.
- If you see an error, go to p. 8.

Figure 3 - Begin Controlling

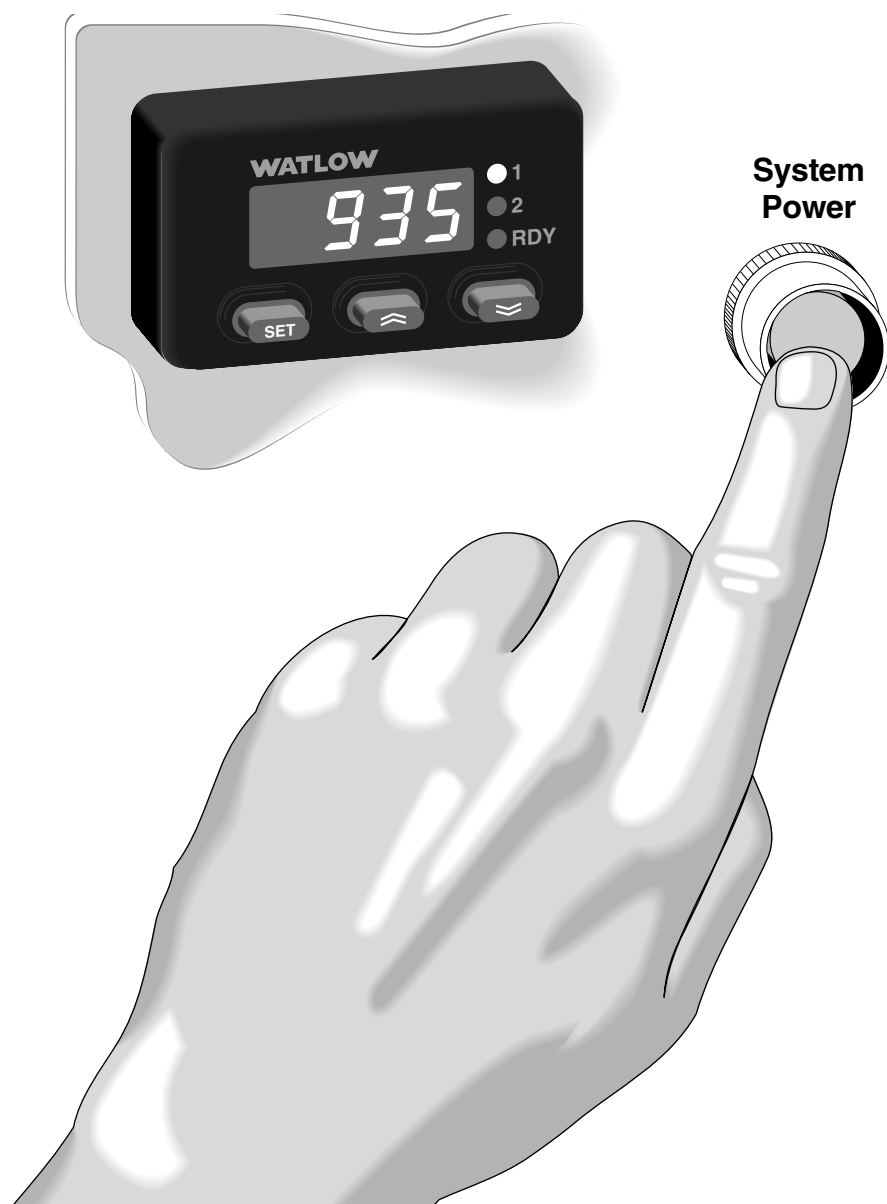



Change Set Point

Your Series 935A displays the actual process temperature when it comes from the factory. You can change it to normally display the set point or time. Go to p. 16, see **DISP.**

1. Press and hold **SET**.
2. Press one of the arrow keys to alter the set point either upward or downward.
3. Release **SET** to complete the change.

Figure 4 - Changing the Set Point













Respond to a simple error

If You See An Error Code:

1. Be aware that most errors are input (sensor) related.
2. Read the table below and follow its recommendations.

Table 2 - Error messages and recommended action

Display	Probable Cause	Recommended Action
	Reversed thermocouple connection + to -.	Change the sensor leads on Terminals 1 and 2.
	Sensor type mismatch or open RTD.	Go to  prompt, check selection (see p. 20), or check RTD, replace as necessary.
	Sensor type mismatch.	Go to  prompt, check selection (see p. 20).
	Open Thermocouple, bad connection, or broken wire.	Check the sensor, replace as necessary.
	Electrical noise.	Cycle power to system. See if error clears. Check system for electrical interference.
	Control is inoperable.	Check for line voltage at terminals 7 and 8.

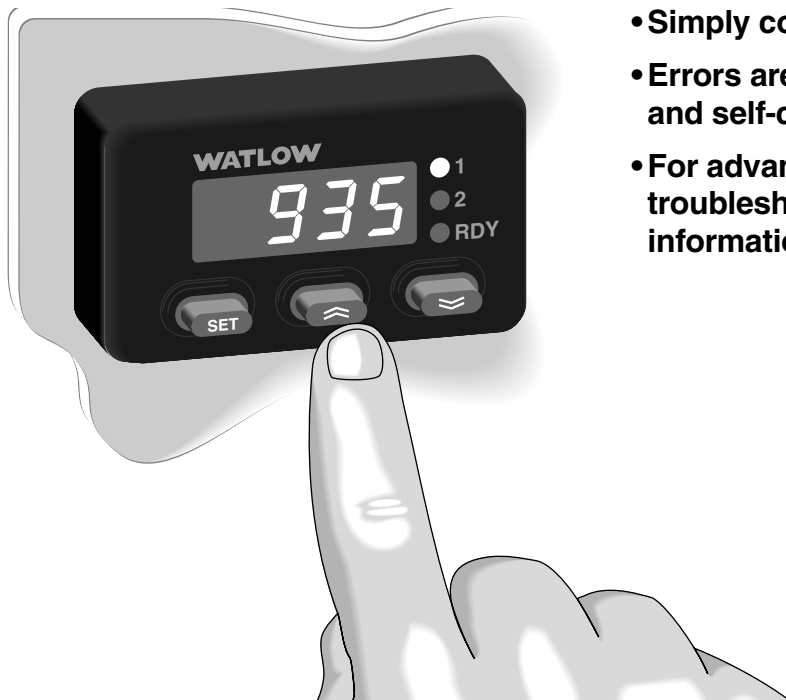

- Simply correct the cause.
- Errors are non-latching and self-clearing.
- For advanced error and troubleshooting information, go to p. 37.

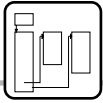

Learn the Software Map

Software Organization

- The Series 935A has three primary menus in addition to a normal display.
- The software reverts to the normal display after 60 ± 5 sec.

Table 3 - Software Organization

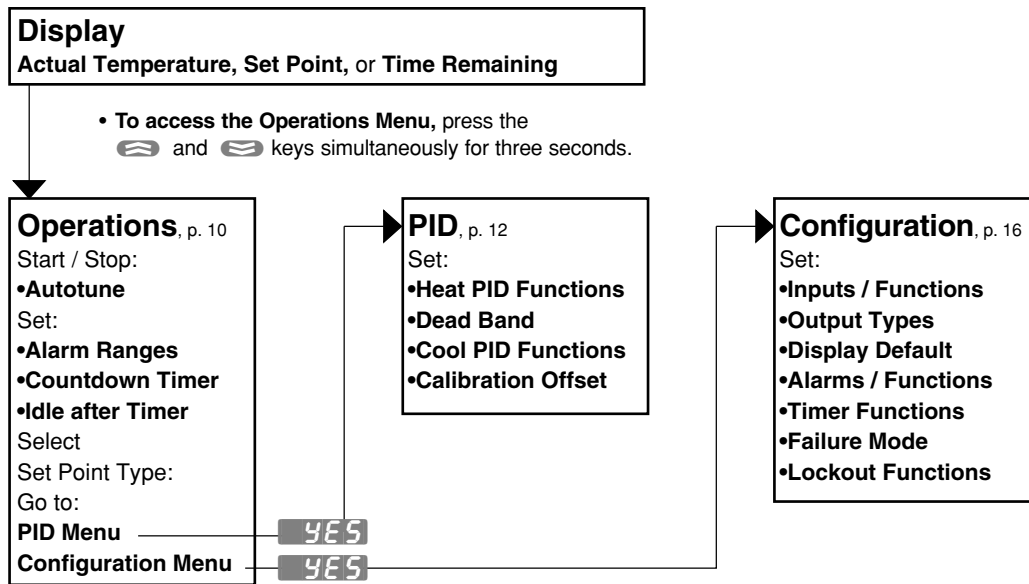

- At the or prompt, press and hold the key, and the or key to select . Release the keys to move to the new menu.

Navigation Example

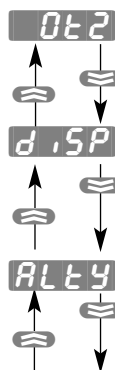

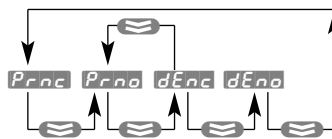

- Move through each menu with the or key.
- Make changes by pressing and holding the key, and then the or key to select a new choice or value. Release the keys to complete the change.



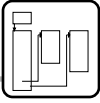























- To exit any menu: Press and hold the and keys for three seconds, or the display will revert to normal display after 60 ± 5 seconds.



Learn the Operations Menu

The Series 935A Operations Menu is the first menu you encounter when you press the  and  keys simultaneously for three seconds. The Operations Menu provides a location to initiate the following actions or complete the following tasks:

- **Auto-tune** : Start or stop the auto-tuning process. Auto-tuning selects a set of viable proportional, integral, and derivative values for heat and/or cool output.
- **Alarm Points**,  and : Select the values for the high alarm point and the low alarm point. Alarm points, dependent on sensor type high and low ranges, reside in the Operations Menu for easy access.
- **Timer Countdown Time** : Select a countdown time value between 00:00 and 99:59 hours:minutes or minutes:seconds. Time interval choices  and  reside in the Configuration Menu for Output 2.
- **Idle Set Point** :  or an adjustable value between  and . Choose to have the Idle Set Point track , or equal, the Primary Set Point; or select an Idle Set Point value in °F or °C between the range low  and range high  values. The Idle Set Point is active both before and after the timing sequence. The normal or Primary Set Point controls during the timing sequence.
- **Local/Remote Set Point** ,  or : Choose to maintain control with the Primary  (local) Set Point, or to enable the Remote  Set Point if the Output 1  choice equals Remote Set Point .
- **Go to the PID Menu** : Choose  to proceed to the PID Menu.
- **Go to the Configuration Menu** : Choose  to proceed to the Configuration Menu.

The table on the next page presents this information in graphic form.

NOTE: Not every prompt listed here or on p. 11 in the Operations Menu will appear in your unit. Prompts vary with lockout function and output set-up. Whether or not prompts appear in the Operations Menu depends on two features of the Series 935A:

- Lockout function; the Lockout Tag  function masks prompts from view in the various menus. (If you cannot see a prompt, you can make no change.) See Using Lockout Functions, p. 18, for more information.
- Output 1 and 2 Configuration; some outputs are mutually exclusive. For example, if Output 1 is Alarm, then Output 2 cannot be Timer. Therefore, the Operations menu will have no timer-related prompts. See the Valid Output Functions Table, p. 3, or Setting Up Inputs and Outputs, p. 20.

Table 4 - Operations Menu Overview

To enter the Operations Menu, press the  and  keys simultaneously for three seconds.

Auto-tune - Start the auto-tune action to automatically select a set of viable PID values; **tune** will flash during auto-tuning.

Aut **no** **YES**
 NO YES

Alarm Low - Select a low alarm point, adjustable between Off, Range Low and Alarm High.

ALD **Ah1**
 Alarm High

Alarm High - Select a high alarm point, adjustable between Alarm Low and Range High, or OFF.

Ah1 **ALD**
 Alarm Low

Countdown Timer - Select a countdown time duration.

tP7r **0000** **9959**
 00:00 to 99:59 Hrs:Min or Min:Sec

Idle Set Point Type - Choose to track set point, or select a separate idle set point adjustable between Range Low and Range High. When **0L1** = **tP7r** or **tP7S**, view the idle set point from the set point display with a three second **SET** press.

IdLE **tP7r** **rl** **rh**
 Track Range Range
 Set Low High
 Point

Local / Remote Set Point - Choose to use the remote set point input.

L-r **L** **r**
 Local Remote

PID Menu - Go to the PID Menu.

Pid **no** **YES**
 NO YES

Configuration Menu - Go to the Configuration Menu.

CnF9 **no** **YES**
 NO YES

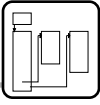

Learn the PID Menu

Choose the PID Strategy

You may rely solely on the Auto-tune **AUT** function (p. 32) and factory defaults to determine PID values for your system, or you may use auto-tuning and additional manual adjustments. You must select dead band **db** and calibration offset **CAL** values manually.

The Series 935A PID Menu is the first sub-menu you encounter after moving to the Operations Menu. The PID Menu provides a software location to select the individual heat or cool proportional band, hysteresis, and cycle time values; and the dead band, integral, derivative, and calibration offset values.

To go to the PID Menu:

1. Go first to the Operations Menu by pressing **⇐** and **⇒** simultaneously for three seconds.
2. Scroll through the Operations Menu with **⇒** until you see the **P id** prompt.
3. While pressing **SET** to display **no**, choose **YES** with **⇐** or **⇒**.
4. Release **SET** to see the first PID prompt.

NOTE: Access to the PID Menu and the prompts there varies with lockout function and output set-up. The PID Menu is locked out when the 935A leaves the factory.

- Lockout function; the Lockout Tag **LRG** function masks menus from view (if you cannot see a prompt, you can make no change). See Using Lockout Functions, p. 18.
- Output set-up; you must choose **HEAT** or **COOL** in either Output 1 or Output 2 to have access to the PID Menu. With a **HEAT** only choice, **COOL** prompts are not visible, and vice versa. See the Valid Output Functions Table, p. 3, or Setting Up Inputs and Outputs, p. 20.

NOTE: Proportional Band, Integral, Derivative, Dead Band, and Calibration Offset values are adjustable in whole or tenth °F or °C, depending on input type **IN and **C_F** Celsius/Fahrenheit Configuration Menu choices.**

Set the PID Menu Values

- **Proportional Band, Heat and Cool** `Pb_h` and `Pb_c`: Select a value (degrees) to set up band on either side (\pm) of the Primary Set Point in which the heat and/or cool proportioning function(s) will be active.
For on/off control, set `Pb_h` or `Pb_c` = 0.
Range: 0 to 999°F/555°C, or 0.0 to 999.0°F/555.0°C
Default: 25°F/17°C, or 25.0°F/17.0°C
- **Hysteresis, Heat and Cool** `hys_h` and `hys_c`: For use with on/off control only. Select the value (degrees) for the process variable change required to re-energize the control heat and/or cool output.
For ON/off control, set `Pb_h` or `Pb_c` = 0.
Range: 1 to 999°F/555°C, or 0.1 to 999.0°F/555.0°C
Default: 3°F/2°C, or 3.0°F/2.0°C
- **Cycle Time**, `ct_h` and `ct_c`: Select the value (seconds) required for the heat and/or cool output(s) to complete a full ON through off cycle.
Range: Switched dc/Solid State Relay: 0.1 to 60.0 seconds
Default: 5.0 seconds
Range: Electromechanical Relay: 5.0 to 60.0 seconds
Default: 30.0 seconds
- **Dead Band** `db`: Dead Band adjusts the effective cool set point above the primary set point by the Dead Band value in degrees. This creates a band between the heating and cooling proportional bands where only integral and derivative activity will occur. For more information on Dead Band fine tuning, go to p. 33.
Range: 0 to 999°F/555°C, or 0.0 to 999.0°F/555.0°C
Default: 0°
- **Integral** `it`: Select a value (minutes/repeat) for the integral function. Integral is the inverse of Reset; $It(\text{value}) = 1/\text{Reset}(\text{value})$.
Range: 0.00 to 99.99 minutes/repeat
Default: 5.00 minutes/repeat
- **Derivative** `de`: Select a value (minutes) for the derivative function.
Range: 0.00 to 9.99 minutes
Default: 0.00 minutes
- **Calibration Offset** `cal`: Eliminates the difference between the displayed process temperature and the actual process temperature value.
Range: -999 to 9999°F/C, or -99.9 to 999.9F/C
Default: 0°

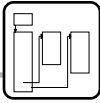

Learn the PID Menu - Details

Table 5 - PID Menu Overview

Set-Up Heat

Proportional Band Heat - Select a heat proportional band value.

Pb h	0 999	0 555	0.0 999.0	0.0 555.0
	0°F to 999°F, or	0°C to 555°C, or	0.0°F to 999.0°F, or	0.0°C to 555.0°C

Hysteresis Heat - Select a heat ON/off control switching hysteresis.

hYSh	1 999	1 555	0.1 999.0	0.1 555.0
	1°F to 999°F, or	1°C to 555°C, or	0.1°F to 999.0°F, or	0.1°C to 555.0°C

Cycle Time Heat - Select a cycle time for the heat output.

Ct h	0.1 60.0	5.0 60.0
	0.1 to 60.0 seconds (SSR or Switched dc)	5.0 to 60.0 seconds (Electromechanical Relay)

Dead Band - Select a dead band value.

db	0 999	0 555	0.0 999.0	0.0 555.0
	0°F to 999°F, or	0°C to 555°C, or	0.0°F to 999.0°F, or	0.0°C to 555.0°C

Set-Up Cool

Proportional Band Cool - Select a cool proportional band value.

Pb c	0 999	0 555	0.0 999.0	0.0 555.0
	0°F to 999°F, or	0°C to 555°C, or	0.0°F to 999.0°F, or	0.0°C to 555.0°C

Hysteresis Cool - Select a cool ON/off control switching hysteresis.

hYSc	1 999	1 555	0.1 999.0	0.1 555.0
	1°F to 999°F, or	1°C to 555°C, or	0.1°F to 999.0°, or	0.1°C to 555.0°C

Cycle Time Cool - Select a cool output cycle time.

Ct c	0.1 60.0	5.0 60.0
	0.1 to 60.0 seconds (SSR or Switched dc)	5.0 to 60.0 seconds (Electromechanical Relay)

Set-Up General

Integral Function - Select an integral value.

 0.00 to 99.99 minutes/repeat





Derivative Function - Select a derivative value.

 0.00 to 9.99 minutes

Calibration Offset - Select a calibration offset value.

 -999° to 9999°F or C or -99.9° to 999.9°F or C

Note: Access to the PID Menu and the prompts there varies with lockout function and output set-up. The PID Menu is locked out when the 935A leaves the factory.

- Lockout function; the Lockout Tag  function masks menus from view (if you cannot see a prompt, you can make no change). See Using Lockout Functions, p. 18.
- Output set-up; you must choose  or  in either Output 1 or Output 2 to have access to the PID Menu. With a  only choice,  prompts are not visible, and vice versa. See the Valid Output Functions Table, p. 3, or Setting Up Inputs and Outputs, p. 20.

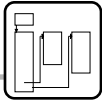

Learn the Configuration Menu

The Configuration Menu is the second sub-menu in the Operations Menu. Use it to set Inputs, Ranges, Output Types, Alarms, Timer, Failure Mode, and Lockouts.

To go to the Configuration Menu:

1. Go first to the Operations Menu by pressing and simultaneously for three seconds.
2. Scroll through the Operations Menu with until you see the **[nF9]** prompt.
3. While holding **SET** to display **no**, choose **YES** with or .
4. Release **SET** to see the first **[nF9]** prompt, **in**.
5. To leave the Configuration Menu, press and for 3 seconds.

Table 6 - Configuration Menu Overview

Input Type - Choose sensor type. See p. 21 for sensor ranges.	
	J t/c K t/c T t/c N t/c E t/c S t/c 1.0° RTD 0.1° RTD
Celsius/Fahrenheit - Choose displayed unit of measure.	
	°F °C
Input Range Low - Select lowest displayable set point. Ranges, p. 21.	
	Select a value (lowest displayable set point) between Input Type Range Low and Input Range High.
Input Range High - Select highest displayable set point. Ranges, p. 21.	
	Select a value (highest displayable set point) between Input Type Range High and Input Range Low.
Output 1 Function - Choose Output 1 type; see Valid Outputs Table, p. 21.	
	Heat Cool Alarm Remote Set Point Front Panel Lock None
Output 2 Function - Choose Output 2 type (dependent on Output 1 choice).	
	Heat Cool Alarm Timer Hr./Min. Timer Min./Sec None
Display Default - Choose the primary (last 2 characters) and secondary (first 2 characters) default displays. Press SET to toggle to the secondary display for 15 seconds.	
	No secondary Actual temp. Actual temp. Set point temp. Actual temp. Time remaining Time remaining Actual temp. Time remaining Set point temperature
Alarm Type - Choose alarm type with output action.	
	Process normally closed Process normally open Deviation normally closed Deviation normally open



Using Lockout Functions

Configuration Menu

ln
Input Type
C_F
Celsius/Fahrenheit
rL
Input Range Low
rH
Input Range High
0E1 ✓
Output 1 Function
0E2
Output 2 Function
dISP
Display Default
ALtY
Alarm Type
AhYS
Alarm Hysteresis
LAt
Alarm Latch
SIL
Alarm Silencing
FAIL
Failure Mode
tIP7
Timer Function
StEt
Start Timer
rdY
Timer Ready Band
St
Signal Time
SLOC ✓
Set Point Lockout
tA9 ✓
Lockout Tag

The Series 935A offers three different security, or “lockout,” options. Set up one or all three lockout options in the Configuration Menu.



- **Front Panel Lock** **FPL** uses a control output as an input for an external hardware switch; it requires wiring, see p. 23. Choose Front Panel Lock **FPL** as an exclusive Output 1 choice. Output 2 offers heat, cool, or alarm.
- **Choose Set Point Lock** **SLOC** as the simplest lockout option. It locks the Primary Set Point from change, but not from view.
- **Choose the Security Tag** **tA9** as a means of masking the Series 935A software menus from view. By selecting all or part of the four-digit binary acronym, **PCOA** (Proportional / Configuration / Operation / Auto-tune), you can choose to mask those items from view, and therefore from change. For example: In the Configuration Menu **tA9** set-up, if you can see the P, the operator cannot see the PID menu.
- Exceptions to **PCOA tA9** are:
 - “C” does not lock out **tA9**.
 - “O” does not lock out **CnF9**.



WARNING: When Output 1 is a Front Panel Lock 0E1 = FPL, the output is energized! Do not connect a power switching device to Output 1; injury or death or damage to equipment or property could result.

Table 7 - Series 935A Lockout Options

Three Lockout Options



Front Panel Lockout



Set Point Lockout

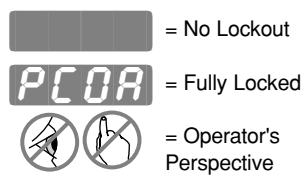

Security Tag



	FPL	no	YES	P	C	O	A
View Process	Yes	Yes	Yes	Yes	Yes	Yes	Yes
View Set Point	Yes	Yes	Yes	Yes	Yes	Yes	Yes
Change Set Point	No	Yes	No	Yes	Yes	Yes	Yes
Auto-tune	No	Yes	Yes	Yes	Yes	Yes	No
View, Change Operation Menu	No	Yes	Yes	Yes	Yes	No	Yes
View, Change Configuration Menu (except tag)	No	Yes	Yes	Yes	No	Yes	Yes
View, Change PID	No	Yes	Yes	No	Yes	Yes	Yes

Note: Front Panel Lockout requires an external hardware switch. For **FPL** set-up and wiring information, see p. 23. For more wiring information, see p. 43.

P = PID Menu
 C = Configuration Menu (except **tA9**)
 O = Operations Menu (except **CnF9**)
 A = Auto-tune



Setting Inputs and Outputs

Configuration Menu

ln ✓
Input Type
C_F ✓
Celsius/Fahrenheit
rL ✓
Input Range Low
rH ✓
Input Range High
0E1 ✓
Output 1 Function
0E2 ✓
Output 2 Function
dISP ✓
Display Default
ALTY
Alarm Type
RhYS
Alarm Hysteresis
LAe
Alarm Latch
SIL
Alarm Silencing
FAIL
Failure Mode
tTR
Timer Function
StT
Start Timer
rdY
Timer Ready Band
St
Signal Time
SLOC
Set Point Lockout
LAG
Lockout Tag

Key Input/Output Set-up Information

- All initial input and output set-up occurs in the Configuration Menu.
- The 935A requires a thermocouple or RTD input connection to the S1 and S2 Terminals, including when using the remote set point **rSP** option.
- Remote Set Point **rSP** is a second input, wired to OT1 Terminals 3 and 4.
- Indication of °C or °F units of measure occurs only in the **C_F** prompt.
- Sensor input type minimum and maximum range (see p. 51) is further defined with Range Low **rL** and Range High **rH** to set the working span of set points and remote set point scaling.
- Output 1 and Output 2 configure the prime functions of the Series 935A, they are the “golden” prompts.
- Output 1 must be heat or cool to use Output 2 as a timer.
- Remote Set Point **rSP** enables Output 1 to act as an input for 0-5V (dc) from another controller or a transmitter.
- Front Panel Lock **FPL** requires an external switch and 62Ω 0.5 watt resistor wired in parallel on Output 1. Switch open = unlocked; closed = locked. See p. 23.
- Output 2 sets timer interval in hours:minutes **tTR** or minutes:seconds **tTS**.
- Display Default **dISP** lets you choose the primary (last 2 characters) and secondary (first 2 characters) default displays. Press **SET** to toggle to the secondary display for 15 seconds.

- Ac** = Normal Display: Actual Temperature
Secondary: None
- AcSP** = Normal Display: Set Point Temperature
Secondary: Actual Temperature
- Acti** = Normal Display: Time Remaining
Secondary: Actual Temperature
- tAc** = Normal Display: Actual Temperature
Secondary: Time Remaining
- tSP** = Normal Display: Set Point Temperature
Secondary: Time Remaining

Note: Access to Configuration Menu varies with lockout function. See p. 19.

Table 8 - Setting Inputs and Outputs

Input Type - Choose sensor type.

In **J** **H** **t** **n** **E** **S** **rtd** **rt.d**
 J t/c K t/c T t/c N t/c E t/c S t/c 1.0° RTD 0.1° RTD

Input Range Information

J t/c:	32	to	1382°F	or	0	to	750°C
K t/c:	-328	to	2282°F	or	-200	to	1250°C
T t/c:	-328	to	662°F	or	-200	to	350°C
N t/c:	32	to	2282°F	or	0	to	1250°C
S t/c:	32	to	2642°F	or	0	to	1450°C
E t/c:	-328	to	1470°F	or	-200	to	799°C
1° RTD (DIN):	-328	to	1292°F	or	-200	to	700°C
0.1° RTD:	-99.9	to	999.9°F	or	-99.9	to	700.0°C

Celsius/Fahrenheit - Choose displayed unit of measure.

C **F** **°F** **°C**
 °F °C

Input Range Low - Select lowest displayable Set Point, dependent on **In**.

rl **In** **rh** Select a value (lowest displayable set point) between Input Type Range Low and Input Range High.

Input Range High - Select highest displayable Set Point, dependent on **In**.

rh **rl** **In** Select a value (highest displayable set point) between Input Type Range High and Input Range Low.

Output 1 Function - Choose Output 1 type.

0t1 **hEAt** **COOL** **ALAr** **rSP** **FPL** **nonE**
 Heat Cool Alarm Remote Front None
 Set Panel
 Point Lock

- The function of Output 1 determines the options available for Output 2.
- First select the function of Output 1. Refer to the table (right), then select the function of Output 2.

Valid Output Functions

First select Output 1:	Then select Output 2:
Heat	None, Cool, Alarm, Timer
Cool	None, Heat, Alarm, Timer
Alarm	None, Heat, Cool
Remote Set Point	Heat, Cool
Front Panel Lock	Heat, Cool, Alarm
None	Heat, Cool, Alarm

Output 2 Function - Choose Output 2 type (dependent on Output 1 choice).

0t2 **hEAt** **COOL** **ALAr** **tHr** **tMnS** **nonE**
 Heat Cool Alarm Timer Timer None
 Hr./Min. Min./Sec

Display Default - Choose the primary (last 2 characters) and secondary (first 2 characters) default displays. Press **SET** to toggle to the secondary display for 15 seconds.

dISP **Ac** **AcSP** **Act** **tAc** **tSP**
 No secondary Actual temperature Actual temperature Time remaining Time remaining
 Actual temperature Set point temperature Time remaining Actual temperature Set point temperature



Set Up Remote Set Point Input

Configuration Menu

- in**
Input Type

- C-F**
Celsius/Fahrenheit

- rl** ✓
Input Range Low

- rh** ✓
Input Range High

- 0t1** ✓
Output 1 Function

- 0t2**
Output 2 Function

- disp**
Display Default

- fail**
Failure Mode

- slck**
Set Point Lockout

- tag**
Lockout Tag

- Operations Menu**

- Aut**
Auto-tune

- L-r** ✓
Local / Remote

- Pid**
PID

- CnF9**
Configuration

To Set Up Remote Set Point...

1. Wire the control per the example below and the information on p. 42-45.
2. Go to **CnF9**, make **in** and **C-F** choices, then
3. Make **in** and **C-F** choices, then
4. Scale the 0-5V_{rms} (dc) input with **rl** and **rh**.
5. Go to **0t1**, and choose **rSP**.
6. Go to the Operations Menu; **L-r**, choose **r**.

Output 1



Local / Remote



- Remote Set Point is scaled by **rh** and **rl**.
- 0V input results in a set point of **rl**.
- 5V input results in a set point of **rh**.
- Adjust **rl** and **rh** to match your input to desired set point adjustment.
- The Remote Set Point will display instead of Primary Set Point.
- Auto-tune always uses the Primary Set Point.
- Deviation Alarm uses the active Set Point.

Figure 5 - Remote Set Point Wiring

See p. 42-45 for more wiring information.

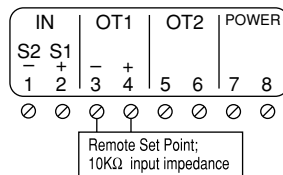

NOTE: Sensor required on Terminals 1 and 2.



WARNING: All wiring and fusing must conform to local and national electric codes. Contact local authorities for further information. Failure to comply with electric codes could result in injury or death, or damage to property.



Set Up Front Panel Lockout

Configuration Menu

<code>ln</code>	Input Type
<code>C_F</code>	Celsius/Fahrenheit
<code>rl</code>	Input Range Low
<code>rh</code>	Input Range High
<code>OT1</code> ✓	Output 1 Function
<code>OT2</code>	Output 2 Function
<code>DISP</code>	Display Default
⋮	
<code>FRIL</code>	Failure Mode
<code>TIPT</code>	Timer Function
<code>Start</code>	Start Timer
<code>rdy</code>	Timer Ready Band
<code>St</code>	Signal Time
<code>SLOC</code>	Set Point Lockout
<code>LR9</code>	Lockout Tag

To Set Up Front Panel Lock...

1. Install an external switch.
2. Wire the control per the example below and the information on p. 42-45.
3. Go to `CF9`, then `OT1`, and choose `FPL`.

Table 9 - Using Front Panel Lock

	<code>OT1 = FPL</code>
<code>OT1</code> <code>FPL</code>	
View Process	Yes
View Set Point	Yes
Change Set Point	No
Auto-tune	No
Reset Alarm	Yes
View or Change Operation Menu (Except Config. Menu)	No
View or Change Configuration Menu (Except Tag)	No
View or Change PID Menu	No

Figure 6 - Front Panel Lock Wiring

See p. 43 for more wiring information.

(Closed switch = locked)

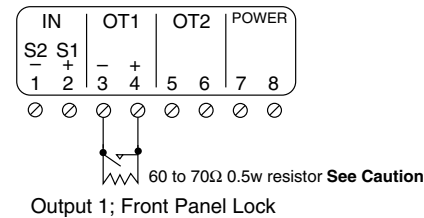

WARNING: When Output 1 is a Front Panel Lock `OT1 = FPL`, the output is energized! Do not connect a power switching device to Output 1; injury or death, or damage to equipment or property could result.



CAUTION: Failure to install a 60 to 70Ω, 0.5 watt resistor across the customer-supplied Front Panel Lock switch will cause the panel to lock out even when the switch is open. Injury to personnel, or damage to equipment or property could result.



Learning Alarms

Configuration Menu

In	
Input Type	
C_F	
Celsius/Fahrenheit	
rL	
Input Range Low	
rH	
Input Range High	
0t1	
Output 1 Function	
0t2	
Output 2 Function	
dISP	
Display Default	
ALTY ✓	
Alarm Type	
AHYS ✓	
Alarm Hysteresis	
LAL ✓	
Alarm Latch	
SIL ✓	
Alarm Silencing	
FAIL	
Failure Mode	
Operations Menu	
Aut	
Auto-tune	
ALO ✓	
Alarm Range Low	
AHI ✓	
Alarm Range High	
PID	
PID	
Configuration	

Alarms signal an excursion from normal operating conditions. In general, audible alarms or lights connected to alarm outputs will signal a problem. In the 935A the front panel LED “1” or “2” indicates an alarm with **HI** or **LO** flashing on the main display.























- **Process alarms** use absolute high and low values to trigger an alarm. Use this alarm type if your process may be subject to temperatures that it must not exceed. Use **AHI** and **ALO** to set alarm points at or near these values. See Table 10: **ALTY**, next page.
- **Deviation alarms** are triggered by a deviation from the set point. The alarm high value **AHI** is the deviation above set point, and the low value **ALO** is the deviation below set point. Whenever the set point is adjusted, the alarm settings are relative to that value. Deviation alarms use the currently controlling set point, whether primary, remote, idle, or 90% of primary, during auto-tuning. See Table 10: **ALTY**, next page.
- **Normally Open, dENO or PRNO, Alarms** energize the alarm output when an alarm condition occurs, and de-energize it when cleared. Use this type to activate external devices such as audible alarms or lights. See Table 10: **ALTY**, next page.
- **Normally Closed, dENC or PRNC, Alarms** de-energize the alarm output when an alarm condition occurs, and energize it when cleared. Use this type as a “deadman” switch where system continuity is required for operation. See Table 10: **ALTY**, next page.

For example, by running the control output through the alarm output, you can set a normally closed process alarm to disable the process when the process exceeds the alarm set point. The alarm output will be off when power is off.

- **Alarm Hysteresis** sets a point the process must pass on a return (from an alarm condition excursion) to the **ALO** and **AHI** points before the alarm can clear. This prevents the alarm output from “chattering” if the process is hovering around the alarm set point. See Table 10: **AHYS**, next page.
- **Latching Alarms** require the operator to clear them with a **B** press after the process returns to a safe, or non-alarm condition. Non-latching alarms self-clear. See Table 11: **LAL**, p. 27.
- **Silenced Alarms** provide a means to clear the alarm output with a **SET** press even if the alarm condition still exists. The flashing **HI** or **LO** message will persist until the alarm condition ceases. See Table 11: **SIL**, p. 27. If **SIL** = **YES**, alarms are disabled (no message or output) on startup until the safe area is reached.
- **Alarm High and Low Points, AHI and ALO**, in the Operations menu determine where alarms will trigger. Alarm hysteresis **AHYS** determines where an alarm condition clears. See Table 11, page 27.
- To Clear an Alarm that is latched or “silence-able” requires the operator to press the **SET** key after the process returns to a safe, or non-alarm condition. Non-latching alarms self-clear. See Table 11: **LAL** and **SIL**, p. 27.

Table 10 (p. 25) and Table 11 (p. 27) illustrate the Series 935A alarm features.

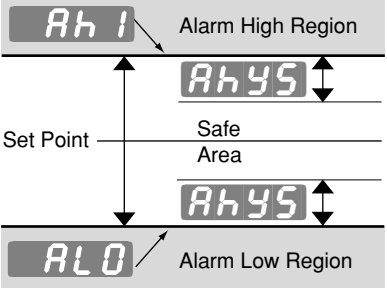
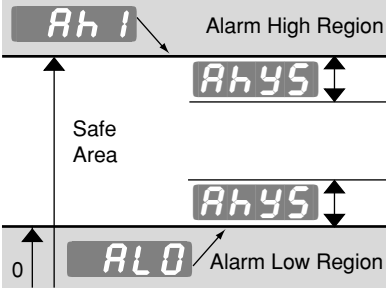
Table 10 - Alarm Functions

 Alarm Type →	Deviation Alarm		Process Alarm	
	 Deviation normally closed	 Deviation normally open	 Process normally closed	 Process normally open
Non-Alarm State LED off Alarm Output:				
Alarm State LED on Alarm Output Status:				
Silenced-Alarm State LED off Alarm Output Status:				
Power-Off State LED off Alarm Output Status:				
Function A deviation alarm tracks set point. A process alarm is a fixed value, independent of set point.				
	Alarm Hysteresis is the change in the process variable (actual) required to clear the alarm relay after an alarm occurs.			



Setting Alarms

Configuration Menu

In
Input Type

C_F
Celsius/Fahrenheit

rL
Input Range Low

rH
Input Range High

Out 1
Output 1 Function

Out 2
Output 2 Function

DISP
Display Default

ALTY ✓
Alarm Type

AHYS ✓
Alarm Hysteresis

LAE ✓
Alarm Latch

SIL ✓
Alarm Silencing

FAIL
Failure Mode

Operations Menu

Aut
Auto-tune

ALO ✓
Alarm Range Low

AHI ✓
Alarm Range High

PID
PID

CFG
Configuration

1. Plan an alarm strategy. What do you want to happen when an alarm occurs?
2. Wire the appropriate control output, Output 1 or Output 2, and associated switching and annunciators. See p. 42-45 for wiring information.
3. Go to the 935A's Configuration Menu **CFG**. See p. 16.
4. Set either Output 1 **Out 1** or Output 2 **Out 2** as the **ALTY** output.
5. Set Alarm Type **ALTY**.
6. Set alarm hysteresis **AHYS**.
7. Set alarm latching **LAE**.
8. Set alarm silencing **SIL**.
9. Set a failure mode **FAIL**. See p. 36-37.
10. Go to the 935A's Operation Menu. See p.10.
11. Set the alarm high and low **ALO** and **AHI** points.
12. Test and adjust the alarm system.
13. Document the alarm settings and system.



CAUTION: Verify, in Table 10, p. 25, the alarm state / alarm output condition you want before making the Alarm Type **ALTY** choice. Failure to do so could result in damage to equipment and property.



WARNING: Do not rely on the Series 935A alarms to provide redundant temperature limit control. Use correctly specified, properly installed temperature limit controls instead. Failure to do so could result in injury, death or damage to equipment and property. (See accompanying Watlow Bulletin 89.4.3.)









To Clear a Series 935A Alarm

In general, press the **SET** key to clear a latched or 'silence-able' (**SIL** = **YES**) alarm.

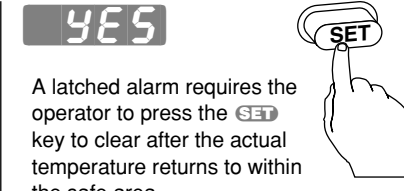
Ultimately, the system process value must return within the safe area for the alarm to remain clear. Non-latching alarms self-clear.

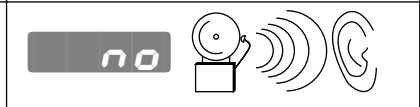
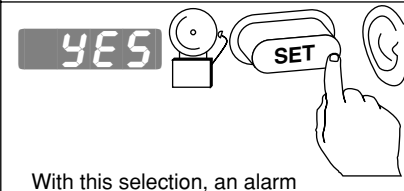
Table 11 (below) and Table 10 (p. 25) illustrate the Series 935A alarm features.

Table 11 - Alarm Functions

 <p>Latching alarm</p>	 <p>An unlatched alarm self-clears when actual temperature returns to within the safe area.</p>	 <p>A latched alarm requires the operator to press the SET key to clear after the actual temperature returns to within the safe area.</p>
 <p>Silence alarm</p>	 <p>With this selection, an alarm cannot be silenced at the 935A front panel (unless the alarm is latched [LAL = YES], and the alarm condition no longer exists).</p>	 <p>With this selection, an alarm can be silenced by pressing the SET key. YES provides automatic alarm silencing on start up.</p>
 <p>Alarm Low</p>	<p>A value from input Range Low to Rh1.</p> <p>At the Range Low value, a  press displays OFF and Rh1 disables.</p>	
 <p>Alarm High</p>	<p>A value from ALo to input Range High</p> <p>At the Range High value, a  press displays OFF and Rh1 disables.</p>	

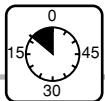

Learn the Countdown Timer

Configuration Menu

In	
Input Type	
C F	
Celsius/Fahrenheit	
rL	
Input Range Low	
rH	
Input Range High	
0t1	
Output 1 Function	
0t2 ✓	
Output 2 Function	
dISP ✓	
Display Default	
ALtY	
Alarm Type	
hYS	
Alarm Hysteresis	
•	
•	
tIPt ✓	
Timer Function	
StEt ✓	
Start Timer	
rdY ✓	
Timer Ready Band	
St ✓	
Signal Time	

Operations Menu

Aut	
Auto-tune	
tPTr ✓	
Countdown Timer	
IdLE ✓	
Idle	

- The timer requires Output 1 to work as either a heat or as a cool output.
- The 935A timer is a function of Output 2, which, depending on your unit's model number, can be either switched dc, electromechanical relay, or solid state relay.
- Hours: minutes (hh:mm) or minutes:seconds (mm:ss) choices reside in Output 2 **0t2**.
- Timer set-up occurs in two locations, in the Configuration Menu and the Operations Menu.
- **⏸** starts the timer.
- **⏹** stops the timer.
- **dISP** choices set up the timer display (see p. 16).
- LED colon flashes when timer runs.
LED colon ON steadily when timer is not running.

Configuration Menu set-up includes: (see p. 16)

- Output 1 **0t1**; heat **HEAt** or cool **COOL**.
- Output 2 **0t2**; timing interval, hours:minutes **tHPt**, or minutes:seconds **tPmS**.
- Timer (Output 2) function **tIPt** can perform one of four possible actions after timing:
 1. Turn ON, also called, "delay ON" **dLON**.
 2. Turn off, also called, "delay off" **dLOF**.
 3. Toggle ON, also called, "signal ON" **SOON**.
 4. Toggle off, also called, "signal off" **SOOF**.
- Start timer function **StEt** choices:
 1. Immediately start **IPtd**.
 2. Start once inside a ready band **rdY**.
 3. Start once inside a ready band, acknowledging **rdYA** with a **SET** press.
 4. Start immediately on control power up **PUDr** without waiting for the Ready Band temp. or a **⏸** press.
- Ready band width **rdY** above and below set point: degrees.
- Signal time **St** (if applicable) duration: seconds.

Operations Menu set-up includes: (see p. 10)

- Countdown Time **tPTr**: hours:minutes or minutes:seconds.
- Idle Set Point Type **IdLE**, two choices:
 1. Track primary set point (always controls at the set point value).
 2. Set an idle set point for control when not timing.

The next page presents this information in graphic format with additional detail.

Table 12 - Series 935A Timer Functions/Settings

Configuration Menu					
	<p>Timer set-up available only when = or </p> <p>Choose time in hr:min or min:sec.</p>				
<p>Output 2 Timer Output Function; Choose one of four possible output actions for the end of the timer / time periods.</p>	<table border="1"> <tr> <td> <p>Delay ON</p> <p>Output 2 is ON before timing; OFF during timing; ON after timing.</p> </td> <td> <p>Delay OFF</p> <p>Output 2 is OFF before timing; ON during timing; OFF after timing.</p> </td> <td> <p>Signal ON</p> <p>Output 2 is OFF before & during timing; ON after timing; then OFF.</p> </td> <td> <p>Signal OFF</p> <p>Output 2 is ON before & during timing; OFF after timing; then ON.</p> </td> </tr> </table>	<p>Delay ON</p> <p>Output 2 is ON before timing; OFF during timing; ON after timing.</p>	<p>Delay OFF</p> <p>Output 2 is OFF before timing; ON during timing; OFF after timing.</p>	<p>Signal ON</p> <p>Output 2 is OFF before & during timing; ON after timing; then OFF.</p>	<p>Signal OFF</p> <p>Output 2 is ON before & during timing; OFF after timing; then ON.</p>
<p>Delay ON</p> <p>Output 2 is ON before timing; OFF during timing; ON after timing.</p>	<p>Delay OFF</p> <p>Output 2 is OFF before timing; ON during timing; OFF after timing.</p>	<p>Signal ON</p> <p>Output 2 is OFF before & during timing; ON after timing; then OFF.</p>	<p>Signal OFF</p> <p>Output 2 is ON before & during timing; OFF after timing; then ON.</p>		
<p>Start Timer Function</p>	Timer starts immediately on a key press at the normal display without waiting for the Ready Band temperature. Timer only runs in the Ready Band. key starts timer sequence. Ready Acknowledge. key starts timer sequence. must be pressed once inside the Ready Band to start timer at the normal display. Timer starts immediately on control power up without waiting for the Ready Band temperature or a press. See p. 61.				
<p>Timer Ready Band</p>	<ul style="list-style-type: none"> • = 0, Disables Ready feature. • The RDY front panel LED is lit inside Ready Band for all Timer Start functions. 				
<p>Signal Time</p>	<p>Sets the signal time from 00:01 to 99:59 min:sec to run after Timer.</p>				
Operations Menu					
	Timer Function OFF. Countdown Time 				
<p>Idle Set Point</p>	SP Idle <ul style="list-style-type: none"> • Idle is set point used when not timing. • If Trac selected Idle is the same as Set Point. • The Set Point value controls the process during the Timer sequence. 				

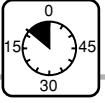

Setting the Countdown Timer

Configuration Menu

In
Input Type

C_F
Celsius/Fahrenheit

rL
Input Range Low

rh
Input Range High

0t1
Output 1 Function

0t2 ✓
Output 2 Function

d1SP ✓
Display Default

ALty
Alarm Type

AhYS
Alarm Hysteresis

•
•
•

t1P7 ✓
Timer Function

Strt ✓
Start Timer

rdy ✓
Timer Ready Band

St ✓
Signal Time

Operations Menu

Aut
Auto-tune

tP7r ✓
Countdown Timer

IdLE ✓
Idle

1. Plan a timer strategy.
2. Wire the Output 2 control output, associated switching devices and annunciators. See p. 42-45.
3. Go to the 935A's Configuration Menu **[CF9]**.
4. Choose the Output 2 **0t2** function as time; hrs:min **tHr7**, or time; min:sec **tP7S**.
5. Choose a display default **d1SP** (see page 16):
 - Actual Temperature only **Ac**
 - Actual; Set Point **AcSP**
 - Actual; Time **Actt**
 - Time; Actual **tAc**
 - Time; Set Point **tSP**
6. Choose a Timer Output Function **t1P7**:
 - Delay ON **dLon**
 - Delay off **dLoF**
 - Signal ON **S9on**
 - Signal off **S9oF**
7. Choose a start timer **Strt** function; either immediate **1P7d**, ready band **rdy**, Ready Acknowledge **rdyA**, or Power **PLUr**.
8. If you chose **rdy** or **rdyA**, then select a ready band **rdy** value.
9. If you chose **S9on** or **S9oF**, then select a signal time **St** value.
10. Go to the 935A's Operation Menu.
11. Set the countdown time **tP7r**.
12. Choose the idle set point **IdLE** to track **tAc** the primary set point, or select a separate idle set point value between the range high **rh** and range low **rL** values.
13. Run the system, and test the timer start with a **SET** press.
14. Document the timer settings and system.

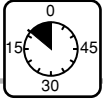

Timer Example

Convection Oven Application

Scenario

A master chef bakes bread at 350°F for 30 minutes. He wants the oven at the proper temperature with an indication when it is ready to begin baking. He isn't concerned if the oven is 10° cool at first. After he loads the oven, the chef wants to start the countdown time by pressing a key. When the baking time is complete, he wants a 10 second audible indication that the bread is done.

Recommended Control

A Series 935A-1CD0-000G control.

- Switched dc Output 1 wired to a dc input solid state relay (SSR) switches the heaters.
- Electromechanical relay Output 2 wired to an AC audible indicator provides “done” indication.

Configuration Menu Set-up

C_F =	°F	°F
d15P =	Act1	After a SET press, actual temperature appears for 15 seconds.
Out1 =	heat	Heating output
Out2 =	tr75	Time; minutes:seconds
tr75 =	5900	Output 2 turns ON briefly at the end of the timing cycle.
Setpt =	rdyR	Timer waits to countdown until temperature deviation from set point < rdy value and the SET key is pressed.
rdy =	10	Ready band; 10°F
St =	10	Output 2 turns ON for 10 sec. at the end of the timing cycle.

Operations Menu Set-up

tr75 =	3000	Bake time; 30 minutes
idle =	75	The set point temperature before a timing cycle starts and after a timing cycle completes.
Set Point =	350	°F

Operator/Control Actions

- With the oven "idling" at 75°F, the chef starts the preheat cycle with a **PRE** press. The display immediately shows 30:00 with the colon ON steadily. The RDY LED is off. Series 935A begins to control to the 350°F bake set point.
- As the actual oven temperature increases to within the Ready Band at 350°F ±10°F, the RDY LED turns on. The chef loads the oven and presses **B** to acknowledge the Ready Band and thereby start the bake cycle.
- Time starts counting down. Actual temperature displays for 15 seconds after the **SET** key is press. Then time displays with the colon flashing.
- If temperature deviates out of the Ready Band (less than 340°F or more than 360°F), timer countdown will pause, but will continue as soon as temperature re-enters the ready band.
- When time reaches 00:00, Output 2 turns on for 10 seconds sounding the audible indicator. The chef can stop the audible indicator by pressing **PRE**. The Series 935A then automatically shifts to the 75°F idle set point.



Auto-tuning

Operations Menu

Aut ✓
Auto-tune
ALO
Alarm Range Low
AhI
Alarm Range High
CTTr
Countdown Timer
IdLE
Idle
L-r
Local / Remote
Pid
PID
CF9
Configuration

Auto-tuning

Auto-tune automatically sets PID parameters for your system.

1. Press **≡** and **≡** for three seconds.
2. You'll see **Aut**.
3. Press and hold **SET**, then select **YES** with **≡** or **≡**. **tunE** will flash to indicate auto-tuning. Display reverts to normal after auto-tuning.
4. **Aut** = **no** stops auto-tuning.

Figure 7 - Auto-tuning the Series 935A

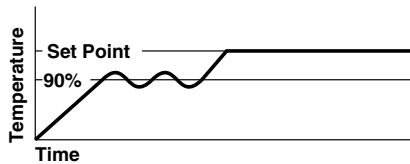

Auto-tuning occurs at 90% of set point in less than or equal to 85 minutes.

NOTE:

Aut is not visible at factory default.



CAUTION:

Successful Series 935A auto-tuning requires 3 oscillations thru the 90% set point in 85 min. or less. If the system cannot perform the oscillations in that time, the control will revert to the previous PID values.

NOTE:

Manual tuning is a slow procedure, taking from minutes to hours to obtain optimum value.

Manual Tuning

For optimum performance, tune the Series 935A to your thermal system. The settings here are for a broad spectrum of applications; your system may have different requirements.

Tune heating outputs at a set point above ambient temperature.

Tune cooling outputs at a set point below ambient temp.

1. Apply power to the 935A and enter a set point. In the Operations Menu, **Aut** must = **no**. Begin with these Configuration Menu settings:
Pb h = **1**, **Ie** = **000**, **de** = **000**,
Ct h = **5.0**, **cal** = **0**.
2. Proportional Band Adjustment: Gradually increase **Pb h** until the upper display temp. stabilizes at a constant value.
3. Integral Adjustment: Gradually decrease **Ie** from 30.00 until the display temperature begins to oscillate or "hunt." Then slowly increase **Ie** until the upper display stabilizes again near set point.
4. Cycle Time Adjustment: Set **Ct h** as required. Faster cycle times sometimes achieve the best system control. However, if a mechanical contactor or solenoid is switching power to the load, a longer cycle time will minimize wear on relays.
5. Derivative Adjustment: Increase **de** to 0.10 minute. Then raise set point by 20° to 30°F, or 11° to 17°C. Observe approach to set point. If load temperature overshoots, increase **de** by 0.50 minute. Raise set point by 20 to 30°F, or 11 to 17°C and watch approach again. Repeat until system rises to new set point appropriately.
6. Calibration Offset Adjustment: Enter the **cal** offset value you want. Calibration offset adds or subtracts degrees from the value of the input signal.



Fine Tune the PID Settings

PID Menu

Set up Heat:

Pb h ✓
Proportional Band

HYSH ✓
Hysteresis

Ct h ✓
Cycle Time

db ✓
Dead Band

Set up Cool:

Pb c ✓
Proportional Band

HYSc ✓
Hysteresis

Ct c ✓
Cycle Time

Set up General:

It ✓
Integral

dE ✓
Derivative

CAL ✓
Calibration Offset

1. Set **Pb h** and **Ct h** in degrees.
2. If Proportional Band Heat **Pb h** = 0, Set Hysteresis Heat **HYSH**. The Series 935A will provide on/off control with the hysteresis value selected, and no proportioning action.
3. Proportional Bands should be decreased for tighter control but increased to eliminate oscillations.
4. Cycle Time Heat **Ct h** is limited to a minimum of 5.0 seconds for the electromechanical relay to help reduce wear. The electromechanical relay (D, Output 2) is not recommended for PID control. It is warranted to 100,000 contact closures only. Alarm or on/off control are appropriate applications for the Series 935A's electromechanical relay output.
5. Set Dead Band **db** to adjust the effective cool set point above the primary set point by the dead band value in degrees. In cool/heat applications, dead band prevents continuous cool output action by creating a buffer between heating and cooling output action.
6. Set **Pb c** and **Ct c** in degrees.
7. If Proportional Band Cool **Pb c** = 0, Set Hysteresis Heat **HYSc**. The Series 935A will provide on/off control with the hysteresis value selected, and no proportioning action.
8. Proportional Bands should be decreased for tighter control but increased to eliminate oscillations.
9. Cycle Time Heat **Ct c** is limited to a minimum of 5.0 seconds for the electromechanical relay to help reduce wear. The electromechanical relay (D, Output 2) is not recommended for PID control. It is warranted to 100,000 contact closures only. Alarm or on/off control are appropriate applications for the Series 935A's electromechanical relay output.
10. Set Integral **It** to eliminate droop in the system. Lower the value for more droop reduction. Adjustable from 0 to 99.9 minutes / repeat.
11. Set Derivative **dE** to prevent overshoot. Increasing the value slows the approach to set point. Adjustable from 0 to 9.99 minutes.
12. Calibration Offset **CAL** eliminates the difference between the displayed process temperature and the actual process temperature value.



Calibrating the 935A

Calibration Menu

tc50 ✓
tc00 ✓
tc ✓
r15 ✓
r380 ✓
rst ✓

Quick Calibration Restore:

Press all three keys simultaneously until **tc50** appears in the display, press **⇐** once and **rst** will appear in the display. Press and hold **SET**, the display will show **no**, press **⇐** to change display to **YES**. Press and hold **⇐** and **⇐** for 3 seconds to exit the **CAL** menu.

NOTE: Restore Factory Calibration

rst = YES restores factory calibration values to all calibration prompts.

Calibration requires a precision millivolt source with thermocouple compensation, an adjustable 0-10 volt source, and a decade resistance box.

- **tc50** and **tc00** calibrate the thermocouple span.
- **tc** calibrates the ambient compensation.
- **r380** and **r15** calibrate the RTD span.
- 0V is required when calibrating **tc00** and **r15** for remote set point calibration.
- 5V is required when calibrating **tc50** and **r380** for remote set point calibration.
- When calibrating, calibrate all points for consistency in results.
- Allow the unit to warm up for 15 minutes before calibrating.

Figure 8a - Thermocouple Calibration

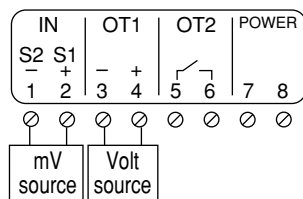

tc50

mV source = 50.000mV
Volt source = 5V

- Store TC counts at 50.000mV
- Store 5V remote set point counts for use with TC

tc00

mV source = 0.000mV
Volt source = 0V

- Store TC counts at 0.000mV
- Store 0V remote set point counts for use with TC

tc

mV source = Temp. Compensation
Volt source = 0V

- Store ambient counts at 32° F. Type J.

Figure 8b - RTD Calibration

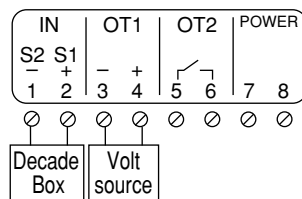

r15

Decade Box = 15.00 ohms
Volt source = 0V

- Store low end RTD counts
- Store 0V remote set point counts for use with RTD

r380

mV source = 380.00 ohms
Volt source = 5V

- Store high end RTD counts
- Store 5V remote set point counts for use with RTD

rst **no**
YES

- Restore factory calibration

Calibrating the 935A and Remote Set Point Input

Thermocouple and Remote Set Point Input Field Calibration Procedure

Equipment Required:

- Type “J” Reference Compensator with reference junction at 32°F/0°C, or Type “J” Thermocouple Calibrator set at 32°F/0°C.
- Precision millivolt source, 0-50mV min. range, 0.01mV resolution.

Set Up:

1. Connect 100-240~ (ac), or 24-28V \approx (ac/dc) to Terminal 7 and Terminal 8.
2. Connect the millivolt source to Terminal 1 negative and Terminal 2 positive.
3. Connect voltage source to Terminal 3 negative and Terminal 4 positive.
4. Apply power to the unit and allow it to warm up for 15 minutes.

Move to the Calibration Menu:

1. Press and simultaneously for 3 seconds.
2. Press or until **LnFg** is displayed.
Press and hold **SET** – press or to select **YES**, then release **SET**.
3. Press or until **LRg** is displayed.
Press and hold **SET**. Press or 8 times (display shall be blank).

Calibration: (Thermocouple)

1. Press and hold **SET**, , and simultaneously for 3 seconds until **LR50** is displayed.
2. Set the mV source to 50.00mV \approx (dc). Set the voltage source to 5.00V \approx (dc). Allow 10 seconds for sources to stabilize. Press and hold **SET**. Press or until **YES** appears. Release **SET**.
3. Press - **LR00** shall be displayed.
4. Set the mV source to 0.00 mV \approx (dc), set voltage source to 0.00V \approx (dc). Allow 10 seconds for sources to stabilize. Press and hold **SET**. Press or until **YES** appears. Release **SET**.
5. Press . **LR** shall be displayed.
6. Set the MV source to 0.00 mV (if using a temperature compensator). Set calibrator to 32°F/0°C.
Set voltage source to 0.00V. Allow 10 seconds for sources to stabilize.
Press and hold **SET**. Press or until **YES** is displayed. Release **SET**.

Calibration: (RTD)

Equipment Required:

- Precision Resistance Box with 0.01 Ω Resolution.
1. Remove thermocouple wires from Terminal 1 and Terminal 2.
 2. Connect S2 to terminal 1. Connect S1 to Terminal 2.
 3. Press . **LR15** shall be displayed.
 4. Connect voltage source to Terminal 3 negative and Terminal 4 positive.
 5. Set the Decade box to 15.00 Ω , set the voltage source to 0.00V (Allow 10 seconds for sources to stabilize). Press and hold **SET**.
Press or until **YES** appears. Release **SET**.
 6. Press - **LR380** shall be displayed.
 7. Set the decade box to 380.00 Ω , set the voltage source to 5.00V. (Allow 10 seconds for sources to stabilize). Press and hold **SET**.
Press or until **YES** appears. Release **SET**.
 8. Press and hold and for 3 seconds to Exit calibration menu.

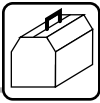

Errors and Troubleshooting

Configuration Menu

ln
Input Type
C-F
Celsius/Fahrenheit
rl
Input Range Low
rh
Input Range High
0t1
Output 1 Function
0t2
Output 2 Function
dISP
Display Default
ALtY
Alarm Type
AhYS
Alarm Hysteresis
LAe
Alarm Latch
SIL
Alarm Silencing
FAIL ✓
Failure Mode
t1P7
Timer Function
StEt
Start Timer
rdY
Timer Ready Band
St
Signal Time
SLOC
Set Point Lockout
LAG
Lockout Tag

Set up an input failure operation mode at the **FAIL** prompt in the **CONF9** menu; choose bumpless transfer **bPLS** for smooth output action transition to percent power control, or select a percent power output value.

FAIL **bPLS**

Bumpless Transfer

when errors occur, the control output will continue at a percent output learned while stable. Default = **bPLS**.

-100 **100**

Percent Power







(-100% to +100% , depending on heat/cool output configuration). The control will assume a specific output power when input errors occur.

- All except one of the possible displayed error messages are input related.
- If you see **ErS**, cycle power to the controller. If the error persists, call the factory.
- Be aware of the difference between U.S and European thermocouple color/colour codes.
- Reversed polarity input leads is one of the most common errors.
- Incorrect software input choice at the Configuration Menu **CONF9** input **ln** prompt is another common error.

When calling the factory for help, please have:

1. The model number of the control.
2. A photocopy of pages 55 to 62 with the settings from your control, if possible.
3. Specifications of devices directly interfaced with the control.

Table 13 - Error Codes and Actions

Display	Probable Cause	Recommended Action	
	Reversed thermocouple connection + to -.	Change the sensor leads on Terminals 1 and 2.	A-D under flow
	Sensor type mismatch or open RTD.	Go to In prompt, check selection (see p. 20), or check RTD, replace as necessary.	Sensor under range
	Sensor type mismatch.	Go to In prompt, check selection (see p. 20).	Sensor over range
	Open Thermocouple, bad connection, or broken wire.	Check the sensor, replace as necessary.	A-D over flow
	Electrical noise.	Cycle power to system. See if error clears. Check system for electrical interference.	
	Control is inoperable.	Check for line voltage at terminals 7 and 8.	

To Troubleshoot Sensor

- Remove sensor wires from Terminals 1 and 2.
- For a thermocouple sensor Series 935A, place a jumper wire on Terminals 1 and 2. Control should display the ambient temperature at the back of the control.
- For an RTD sensor Series 935A, place a 110 +/- 10Ω resistor on Terminals 1 and 2. The control should read 100Ω = 32°F, 110Ω = 77°F, 120Ω = 127°F.
- An RTD sensor Series 935A can be configured in software as if it were a thermocouple unit, and then tested as above.
- You can restore factory calibration , see p. 34-35.

Table 14 - Troubleshoot Control Outputs

When indications such as significant differences between set point and actual temperatures point to no output action, check output configurations as described on p. 23. Check wiring, p. 44.

Output	Measure Terminals	Load-on State	Load-off State
"C" Output 1	3 & 4	LED 1 on 3.0 to 7.0V ^{ac} (dc)	LED 1 off 0.0V ^{ac} (dc)
"C" Output 2	5 & 6	LED 2 on 3.0 to 7.0V ^{ac} (dc)	LED 2 off 0.0V ^{ac} (dc)
"D" Output 2	5 & 6	LED 2 on 0V ^{ac} (dc) Load sees line voltage	LED 2 off line voltage. Load sees 0V ^{ac} (dc)
"K" Output 2	5 & 6	LED 2 on <2V ^{ac} (dc) Load sees line voltage	LED 2 off line voltage Load sees 0V ^{ac} (dc)

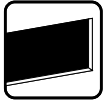

Mounting

Figure 9- Panel Cut-out Dimensions

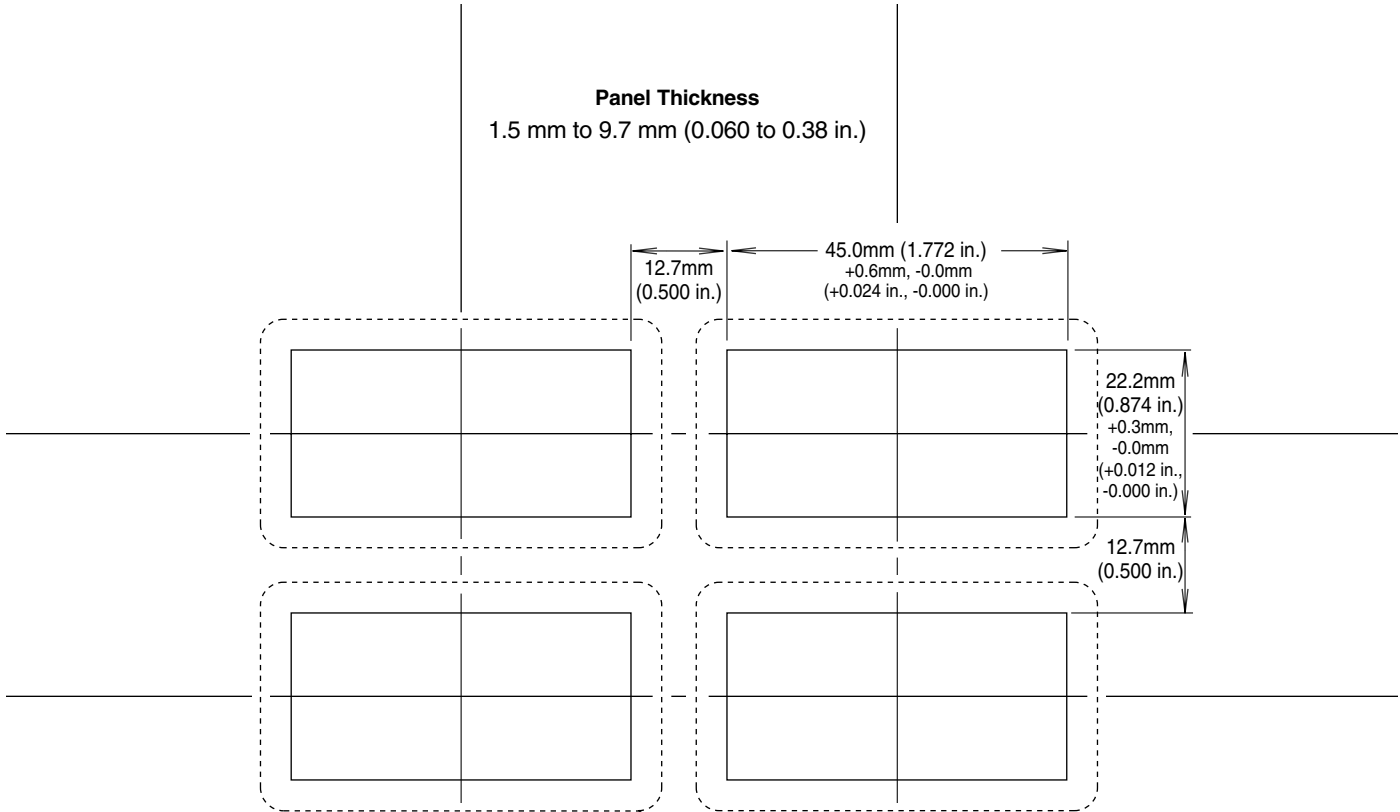
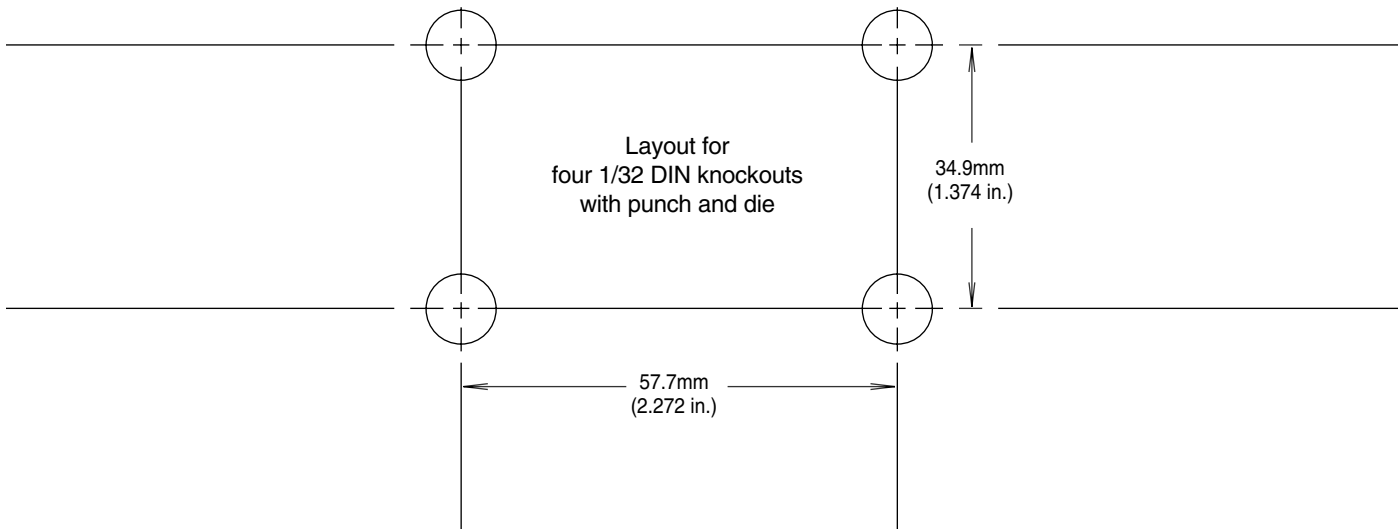

Figure 10- Mounting Layout for Knockouts



Greenlee Textron, Inc., Phone: 1-800-435-0786.
Catalog Number: 50740180; Available: 4-6 weeks, Greenlee distributor.



Dimensions

Figure 11- Series 935A Dimensions

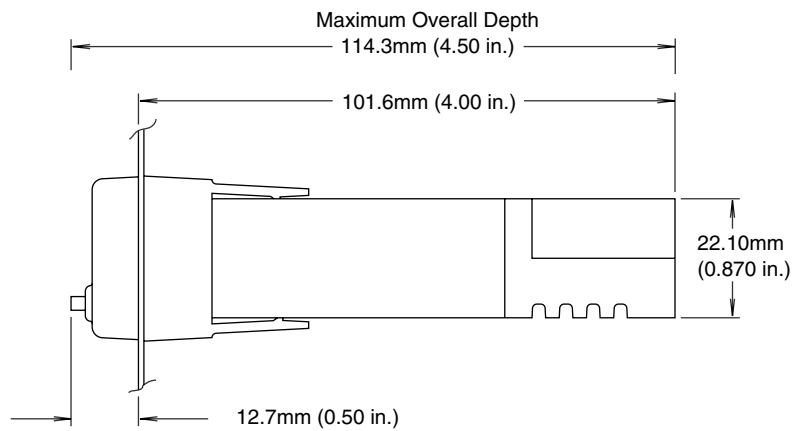
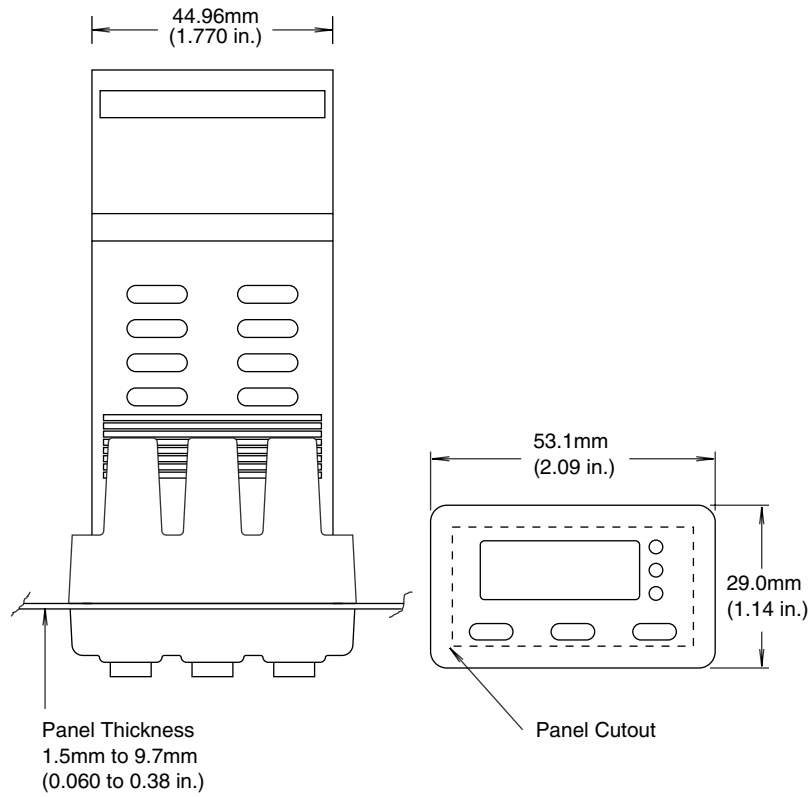

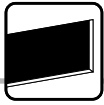

Installation Procedure

1. Make a panel cutout using the dimensions in Figure 9, p. 38.
2. Insert the 935A into the cutout. Check to see that the gasket is not twisted. Make sure the rounded side of the D-shaped external case gasket faces the panel surface, and the gasket is fully seated in its bezel channel. See Figure 12.
3. While pressing the bezel firmly against the panel, slide the mounting collar over the back of the control. The tabs on the collar must line up with the mounting ridges on the case for secure installation. See Figure 12 again.
4. Slide the collar firmly against the back of the panel, getting it as tight as possible. Make sure you cannot move the case within the cutout, if you can, you do not have a IP65/NEMA 4X seal!
5. Make sure you have a tight seal. Use your thumb to lock the tabs into place while pressing the case from side to side. Don't be afraid to apply enough pressure to install the control. The tabs on each side of the collar have teeth which latch into the ridges. See Figure 12. Each tooth is staggered at a different depth (from the front) so only one of the tabs on each side is ever locked into the ridges at any time.
6. Look at Figure 13; you see that the tabs on one side of the collar correspond with those on the opposite side. Be sure only the two corresponding tabs are locked in the ridges at the same time. If the matching tabs are not holding the case, no IP65/NEMA 4X seal exists. Make a visual check, or use your finger nail to pull out on each tab. The space between the bezel and panel must be 0 to 0.48 mm (0 to 0.019 in.).

Collar Removal

Slide a thin, wide tool (putty knife) under all three mounting tabs, top then bottom, while pushing forward on the back of the case.

Figure 12- Mounting, Case Top View and Collar Cross Section.

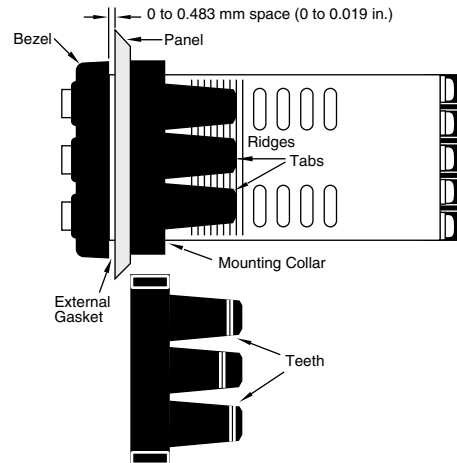
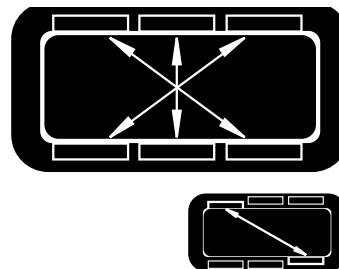

Figure 13- Case Rear View and IP65/NEMA 4X Seal Example



NOTE: To guarantee a proper IP65/NEMA 4X seal, make sure the gasket between the panel and the rim of the case is not twisted and is seated properly. Press firmly.

NOTE: Make sure the rounded side of the D-shaped external case gasket faces the panel surface, and the gasket is fully seated in its bezel channel. See Figure 12.



Terminal Block Removal

Figure 14- Terminal Block Removal Procedure

1. Press in on sides of cover to release the terminal cover hooks.

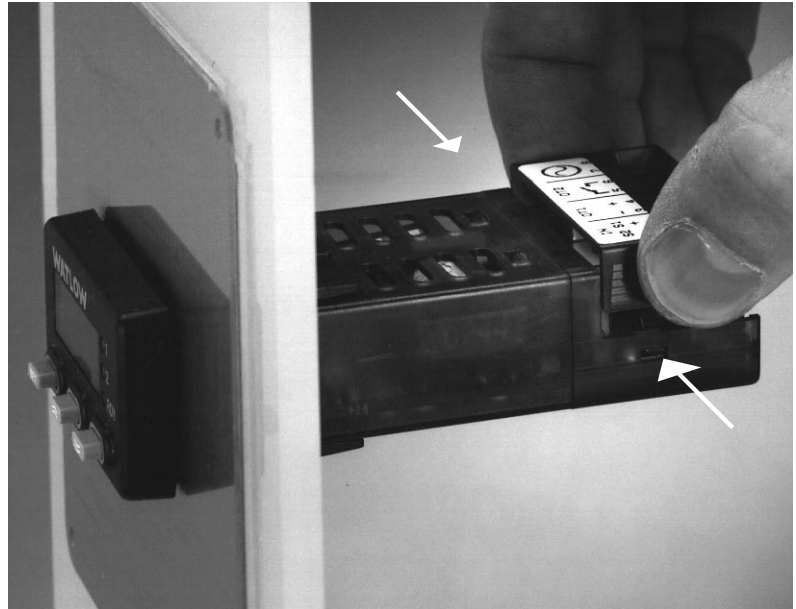

2. Move your grip rearward slightly, then lift the terminal cover straight up.

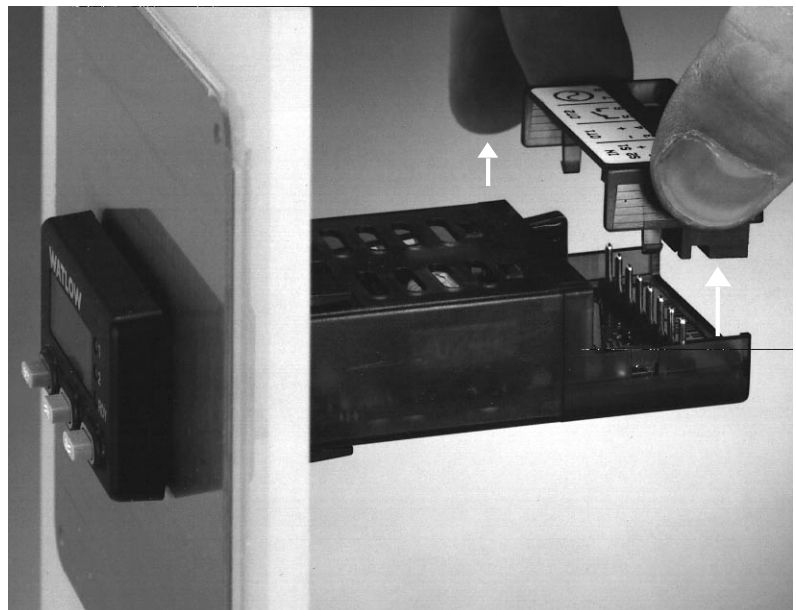



Wiring a 935A

Figure 15 - Wiring the Series 935A



WARNING: All electrical wiring and fusing must conform to local and national electric codes. Contact local authorities for further information. Failure to comply with electric codes could result in injury or death, or damage to property.

Power Wiring

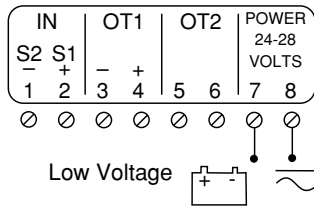
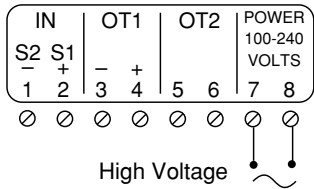

Input Wiring

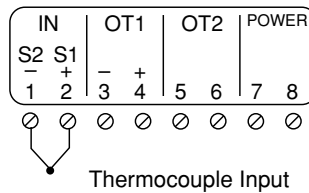
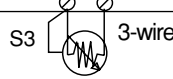
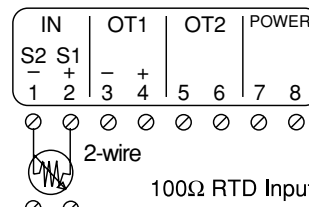
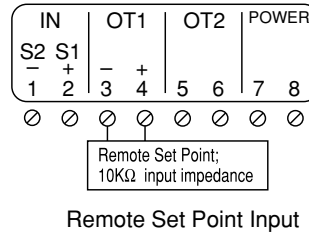

CAUTION: Using grounded thermocouples with non-isolated output switching devices could introduce ground loops into the control system, and possibly damage the controller and product.

NOTE: Torque terminals to 1.36 Nm (12 in lbs).



WARNING: All electrical wiring and fusing must conform to local and national electric codes. Contact local authorities for further information. Failure to comply with electric codes could result in injury or death, or damage to property.

Output 1 Wiring

Internal Circuitry

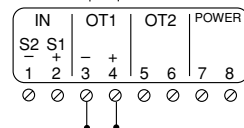
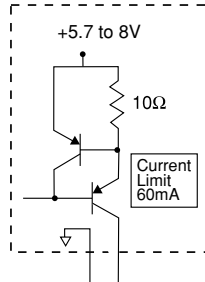

Output 1; Switched DC; "C"

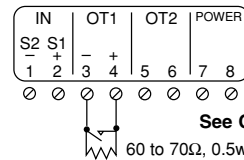

Output 1; Front Panel Lock

Output 2 Wiring

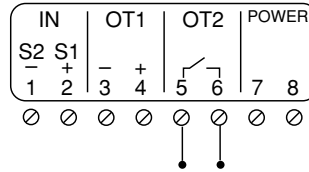

Output 2; Solid State Relay; "K"

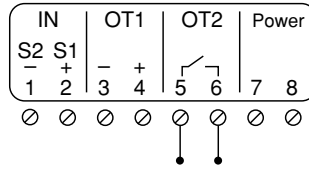

Output 2; Electromechanical Relay; "D"

Internal Circuitry

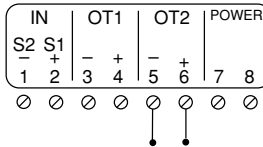
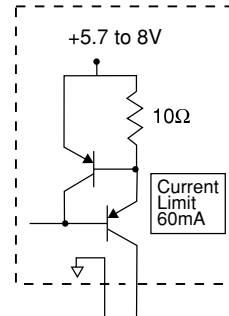

Output 2; Switched DC; "C"



CAUTION: Failure to install a 60 to 70Ω, 0.5w resistor across the customer-supplied Front Panel Lock switch will cause the panel to lock out even when the switch is open. Injury to personnel, or damage to equipment or property could result.



WARNING: When Output 1 is a Front Panel Lock $OT1 = FPL$, the output is energized! Do not connect a power switching device to Output 1; injury or death, or damage to equipment or property could result.

NOTE:

Switching inductive loads (relay coils, solenoids, etc.) with the mechanical relay or solid-state relay output options requires using an R.C. suppressor. Watlow carries the R.C. suppressor Quencharc brand name, which is a trademark of ITW Pakron. Watlow Part No. 0804-0147-0000.



System Wiring Examples

Figure 16 - Series 935A System Wiring Examples



WARNING: All electrical wiring and fusing must conform to local and national electric codes. Contact local authorities for further information. Failure to comply with electric codes could result in injury or death, or damage to property.

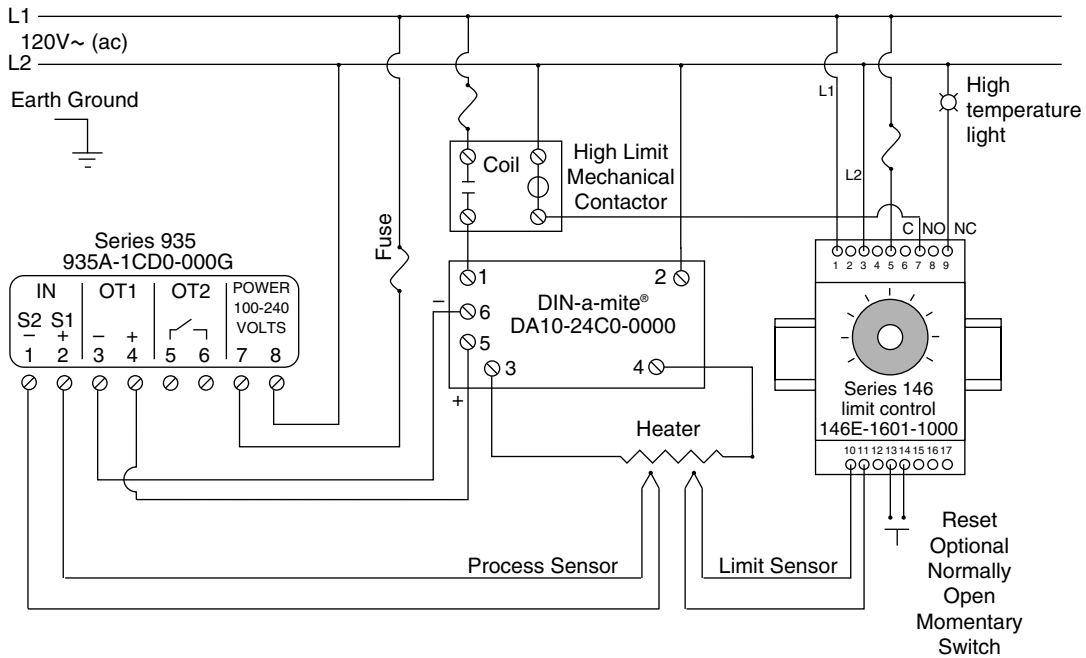

CAUTION: Using grounded thermocouples with non-isolated output switching devices could introduce ground loops into the control system, and possibly damage the grounder and product.

Figure 17 - Series 935A Ladder Diagram Wiring Example



WARNING: All electrical wiring and fusing must conform to local and national electric codes. Contact local authorities for further information. Failure to comply with electric codes could result in injury or death, or damage to property.

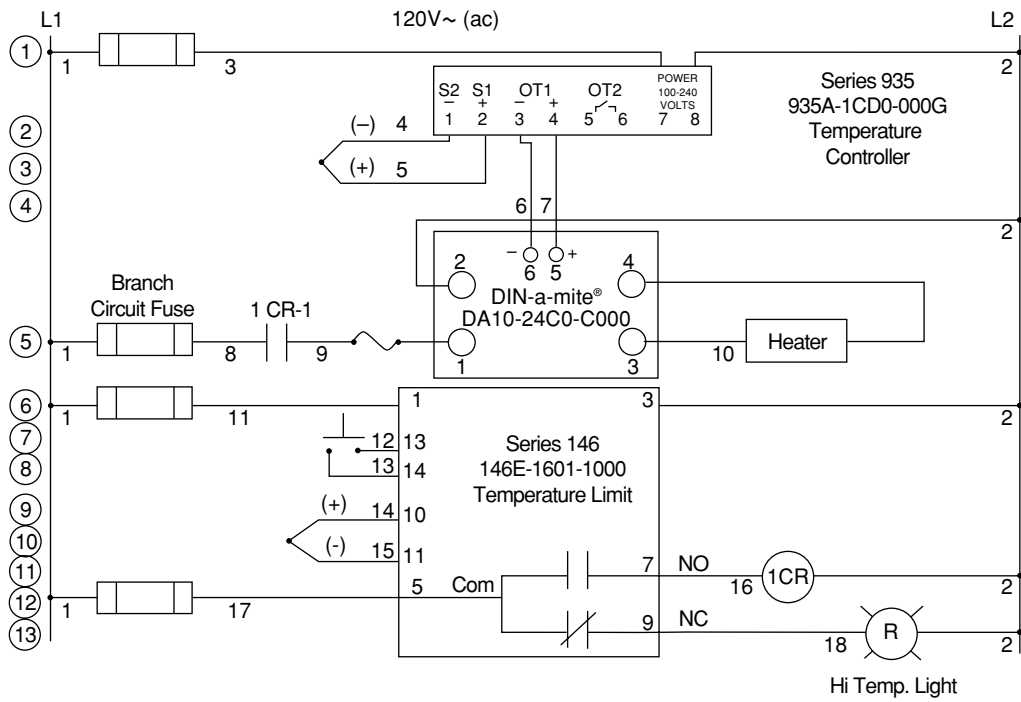



Glossary

Alarm

A condition, generated by the controller, indicating that the process has exceeded or fallen below the set or limit point.

Alarm Hysteresis

A change in the process variable required to re-energize the alarm output.

Ambient Temperature

Temperature surrounding the components of a thermal system.

Auto-tune

Automatically sets PID values to fit a particular thermal system.

Bumpless Transfer

When transferring from auto to manual operation, the control output(s) will maintain the same output level.

Calibration

Adjusting an instrument to a known value.

Configuration Menu

The second software sub menu of the Series 935A Operations Menu; provides a location to set inputs, ranges, output types, alarm type, timer function, failure mode, and lockout types.

Control Mode

The method of control, i.e. ON/OFF, time proportioning, PI, PID or manual.

Cycle Time

Time required for a control to complete one ON through OFF cycle.

Dead Band

Adjusts the effective cool set point above the primary set point by the dead band value in degrees. In cool/heat applications, dead band prevents continuous cool output action by creating a buffer between heating and cooling output action.

Delay OFF

A Series 935A timer output (Output 2) choice that turns the output OFF at the end of the countdown timer time.

Delay ON

A Series 935A timer output (Output 2) choice that turns the output ON at the end of the countdown timer time.

Derivative

Limits the rate of change of the process to eliminate overshoot in slow or lagging loads ($de=ra$).

Deviation Alarm

An offset value which tracks the set point. Process changes beyond this value register an alarm condition.

DIN-a-mite®

Watlow family of DIN rail-mounted SCR power controllers.

Droop

The difference between the set point and actual values once the system stabilizes.

Hysteresis

A change in the process variable required to re-energize the control or alarm output.

Idle Set Point

Desired control value before and after timing period.

Integral

Accumulates error to eliminate offset or droop ($I_t=1/re$).

Local Set Point

Primary set point, not remote.

ON/OFF

Control by turning the output full ON until set point is reached, and then turning OFF until the process error exceeds the hysteresis.

Operations Menu

Series 935A software menu; provides a location to start auto-tune, set alarm points, set countdown time, choose an idle or normal set point type, choose a local or remote set point input, and to go to the PID or Configuration Menus.

Overshoot

The amount a process variable exceeds set point before stabilizing.

Percent Power Control

Open loop control with output power set at a particular level.

PID

(Proportional, Integral, Derivative). A control mode: proportional action sets the system, integral reduces droop, derivative reduces overshoot and undershoot.

PID Menu

The first software sub menu of the Series 935A Operations Menu; provides a location to manually set values for proportional band, hysteresis, cycle time, integral, derivative, and calibration offset.

Process Alarm

A fixed value independent of set point. Process changes beyond this value register an alarm condition.

Process Error

The difference between the set point and the actual process.

Proportional

Output effort proportional to the error from set point. If the proportional band is 20° and the process is 10° below set point, the heat proportioned effort is 50%. The lower the P_b value, the higher the gain.

Proportional Band

A range in which a control's proportioning function is active (See PID).

Range

The area between two limits in which a quantity or value is measured. Usually expressed in terms of lower and upper limits.

Ready Acknowledge

A Series 935A countdown timer start choice that pre-initiates the timer with a down key press, and then starts it with a SET press when the actual temperature is within the Ready

Ready Band

Thermal area above and below primary set point in which the timer will count down.

Relay, Electromechanical

A power switching device that completes or interrupts a circuit by physically moving electrical contacts. Not recommended for PID control.

Remote Set Point

A 0-5V \Rightarrow (dc) input from another controller or other source.

RTD

Resistive Temperature Detector. A sensor whose resistance increases with increasing temperature. Set Point
The desired process value programmed into a control.

Signal

Any electrical transmittance that conveys information.

Signal OFF

A Series 935 timer output (Output 2) choice that toggles the output OFF, then ON at the end of the countdown timer cycle for a period equal to the signal time.

Signal ON

A Series 935 timer output (Output 2) choice that toggles the output ON, then OFF at the end of the countdown timer cycle for a period equal to the signal time.

Signal Time

Time duration the timer output will turn ON or OFF after a complete timing period.

SCR

Silicon controlled rectifier. A solid state device, or thyristor, with no moving parts, that is used in pairs to control AC voltages within one cycle. SCRs control voltage from a power source to the load by burst firing (also called zero-cross firing) or phase angle firing.

SSR

Solid State Relay. A solid state switching device that switches current ON and OFF. It has no moving parts.

Thermal System

A regulated environment consisting of a heat source, heat transfer medium, sensing device, a control instrument, and a redundant control device (limit).

Thermocouple

A temperature sensing device made by joining two dissimilar metals. This junction produces an electrical voltage in proportion to the difference in temperature between the hot junction and lead wire connection to the sensing device (cold junction).

Undershoot

The amount a process variable falls below set point before stabilizing.



Index

A			H	
Auto-tune AUT		10, 32	Hours/Minutes hPM	16, 28
Alarms			Hysteresis	
Alarm High Ah1		10, 24	Alarm AhYS	17, 24
Alarm Low ALD		10, 24	Heat hYSh	13
Alarm Type ALtY		24	Cool hYSc	13
Clearing Alarms		26, 27		
Deviation dEnc , dEno		24	I	
Hysteresis AhYS		24	Idle IdLE	10
Latch LAt		24	Idle Set Point Track trAc	10
Learning		24	Input Range Low rL	20
Process Prnc , Prno		24	Input Range High rh	20
Setting		26	Input Type In	21
Silencing SIL		24	Integral It	13
B			K	
Bumpless Transfer bPLS		36	Keys	5
C			L	
Calibration		34	Latch LAt	17, 24, 27
Factory Restore rSE		34	Local / Remote L-r	10
Calibration Offset CAL		13	Lockout Functions	18
Celsius / Fahrenheit C-F		20	Front Panel FPL	18, 23
Clearing Alarms		26, 27	Security Tag LAG	18
Configuration CnF9		16	Set Point SLOC	18
Cycle Time		13		
Heat Ct h		13	M	
Cool Ct c		13	Minutes/Seconds trTS	17, 28
			Mounting	38
D			O	
Dead Band db		13	Operations, Learning	10
Derivative dE		13	Ordering Information	51
Dimensions		38, 39	Output 1 Function OE1	3, 20
<i>DIN-a-mite</i> ® compatibility		44, 50, 51	Output 2 Function OE2	3, 20
Display Default dISP		16, 20		
			P	
E			PID Menu, Learning	12
Errors		8, 37	PID Settings, Tweaking	33
			Proportional Band	
F			Heat Pb h	13
Failure Mode FAIL		17, 36	Cool Pb c	13
Front Panel Lock FPL		20, 23		
			R	
G			Remote Set Point rSP	20, 22
Glossary		46		

S

Set Point	
Change	7
Local L-r	10
Lock SLOC	18
Range High rH	20
Range Low rL	20
Remote Set Point rSP	22
Remote L-r	22
Silencing Alarms	27
Software Maps	
Easy	9
Advanced	55-62
Specifications	50

T

Terminal Block Removal	41
Timer	
Countdown tPTr	10, 28-31
Delay off dLoF	17, 28
Delay on dLon	17, 28
Function tIPt	17, 28
Hours/Minutes tHtT	17, 28

Idle IdLE	17, 28
Minutes/Seconds tP7S	17, 28
Ready Band rdY	17, 28
Signal off SGoF	17, 28
Signal on SGon	17, 28
Signal Time St	17, 28
Start Timer StTt	17, 28
Immediate IP7d	17, 28
Ready Band rdY	17, 28
Ready Band-Acknowledge rdYA	17, 28
Tuning	
Auto-tuning	10, 32
Manual tuning	32
Troubleshooting	36

W

Wiring	42-43
Wiring Examples	44-45

- Height
- Length
- Width

Specifications

Specifications (2191)

Control Mode

- Auto-tune PID.
- PID, PD, PI, on/off.
- Countdown timer; hours:minutes, minutes:seconds.
- Timer output modes; Delay-off, Delay-on, Signal-off, Signal-on.

Agency Approvals

- UL/C-UL 508 Listed, File #E102269.
- IP65/NEMA 4X² rated front panel.
- CE approved:
 - 89/336/EEC Electromagnetic Compatibility Directive: EN61326 Industrial Immunity, Class A Emissions
 - 73/23/EEC Low-voltage Directive: EN 61010-1: 1993 Safety.

Operator Interface

- Single, seven-segment digital display, factory selectable red or green.
- Outputs/operation annunciators, three discrete LEDs.
- Three tactile feedback momentary switches.
- Front panel lock dry contact closure disables front panel operation.

Accuracy

- $\pm 0.25\%$ of span, ± 1 LSD, or
- Types S and T thermocouple @ $< 200^\circ\text{C}$, $\pm 0.32\%$ of span, ± 1 LSD, typical.

Ambient Rejection

- $< 0.15^\circ\text{C}/^\circ\text{C}$ rise in ambient, or
- Types S and T thermocouple, @ $< 0.47^\circ\text{C}/^\circ\text{C}$ rise in ambient typical.

Sensors/Inputs

- Sensor input sampling rate: 10 samples/second (10Hz).
- Type E, J, K, N, S and T thermocouple, grounded or ungrounded junction.
- RTD, 100 Ω platinum two-wire, DIN curve
- Remote set point input, field-selectable, 0-5V \approx (dc), scalable, 10k Ω input impedance. (Remote Input Option A only.)
- Remote timer start dry contact closure initiates timer start. (Remote Input Option B only.)

Input Range

Specified temperature ranges represent the controller's operational span.

Thermocouple

Type E	-200 to 799 $^\circ\text{C}$ (-328 to 1470 $^\circ\text{F}$)
Type J	0 to 750 $^\circ\text{C}$ (32 to 1382 $^\circ\text{F}$)
Type K	-200 to 1250 $^\circ\text{C}$ (-328 to 2282 $^\circ\text{F}$)
Type N	0 to 1250 $^\circ\text{C}$ (32 to 2282 $^\circ\text{F}$)
Type S	0 to 1450 $^\circ\text{C}$ (32 to 2642 $^\circ\text{F}$)
Type T	-200 to 350 $^\circ\text{C}$ (-328 to 662 $^\circ\text{F}$)

RTD Resolution Platinum 0.00385 Curve

1 $^\circ$	-200 to 700 $^\circ\text{C}$ (-328 to 1292 $^\circ\text{F}$)
0.1 $^\circ$	-128.8 to 537.7 $^\circ\text{C}$ (-199.9 to 999.9 $^\circ\text{F}$)

Control Output

- Output update rate: 1/second (1Hz).

1 Output/Remote Input

- Switched dc logic signal, 6V \approx (dc) @ 60mA nominal, short circuit protected, non-isolated. (Watlow DIN-a-mite[®] power controller compatible).

2 Output

- Switched dc logic signal, 6V \approx (dc) @ 60mA nominal, short circuit protected, non-isolated (Watlow DIN-a-mite[®] power controller compatible).
- Electromechanical¹ relay, Form A, 2A @ 30V \approx (dc) or, 240V \sim (ac), without contact suppression³. (Remote Input Option A only.)
- Solid-state relay, Form A, 0.5A, 24 to 264V \sim (ac), without contact suppression³. Off-state output impedance 31M Ω . (Remote Input Option A only.)

Output Cycle Time

- Switched dc and solid-state relay; 5.0 second default, 0.1 second minimum.
- Electromechanical relay; 30.0 second default, 5.0 second minimum.

Line Voltage/Power

- 100-240V \sim (ac) +10%, -15%; (85-264V \sim [ac]) 50/60Hz, $\pm 5\%$.
- 24-28V \approx (ac/dc) +10%, -15%; (20-31V \approx [ac/dc]) 50/60Hz, $\pm 5\%$. (Remote Input Option A only.)
- Fused internally (factory replaceable only) time-lag type, 2A, 250V.
- Power consumption 6VA maximum.
- Data retention upon power failure via non-volatile memory.
- Switching supply speed 45kHz, $\pm 5\text{kHz}$.

Operating Environment

- 0 to 65 $^\circ\text{C}$ (32 to 149 $^\circ\text{F}$).
- 0 to 90% RH, non-condensing.

Storage Temperature

- -40 to 85 $^\circ\text{C}$ (-40 to 185 $^\circ\text{F}$).

Terminals

- Touch-safe set screw type, accepts 0.5 to 4mm² (22 to 12 AWG wire). Torque to 0.1 Nm (4.5 in lbs).

Controller Weight

- 113 g (4.0 oz).

Shipping Weight

- 207 g (7.3 oz).

These specifications are subject to change without prior notice.

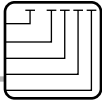

Ordering a 935A

Ordering Information (2192)

Single thermocouple or RTD (DIN) input, dual output, single display temperature control with time function and four digit display

935 -1C - 0

Remote Inputs

- A = Remote set point input, or front panel lock input in place of output #1
- B = Separate input for remote timer start, or front panel lock

Output 1/Remote Input

- C = Switched dc, logic signal, non-isolated; (Watlow *DIN-a-mite*® power controller compatible)
(Optionally used for remote set point input; or front panel lock input for Remote Input A option only.)

Output 2

- C = Switched dc, logic signal, non-isolated (Watlow *DIN-a-mite*® power controller compatible)
- D = Electromechanical relay ¹, Form A, 2A, 240V~ (ac), without contact suppression ³ (Remote Input A option only.)
- K = Solid-state relay, 0.5A, 24-264V~ (ac), without contact suppression ³ (Remote Input A option only.)

Power Supply

- 0 = 100 to 240V~ (ac) nominal (high voltage)
- 1 = 24 to 28V~ (ac/dc) nominal (low voltage) (Remote Input A option only.)

Custom Options

- 00 = None
- AA = No Watlow logo
- XX = Custom label or parameters

Display

- R = Red displays
- G = Green displays

Table 15 - Input Range Information

J t/c:	0 to 750°C	or	32 to 1382°F
K t/c:	-200 to 1250°C	or	-328 to 2282°F
T t/c:	-200 to 350°C	or	-328 to 662°F
N t/c:	0 to 1250°C	or	32 to 2282°F
S t/c:	0 to 1450°C	or	32 to 2642°F
E t/c:	-200 to 799°C	or	-328 to 1470°F
1° RTD (DIN):	-200 to 700°C	or	-328 to 1292°F
0.1° RTD:	-99.9 to 700.0°C	or	-99.9 to 999.9°F

- ¹ Electromechanical relays are warranted for 100,000 closures only. Solid-state switching devices are recommended for applications requiring fast cycle times or extended service life.
- ² To effect IP65 (NEMA 4X) rating requires a minimum mounting panel thickness of 1.5mm (0.06 inch) and a surface finish not rougher than 0.000812 mm (0.000032 in.).
- ³ When using this output to drive a solenoid, MDR or electromechanical relay (contactor), protect output with a Quencharc®. Order code number 0804-0147-0000. Refer to owner's manual for wiring information. Quencharc® is a registered trademark of ITW Paktron.

Declaration of Conformity

Series 935



WATLOW Winona, Inc.
1241 Bundy Boulevard
Winona, Minnesota 55987 USA

Declares that the following product: **English**

Designation: Series 935
Model Numbers: 935(A or B) – 1C(C, D or K)(0 or 1) – (Any four letters or numbers)
Classification: Temperature control, Installation Category II, Pollution degree II
Rated Voltage: 100 to 240 V~ (ac) or 24 to 28 V ≈ (ac or dc)
Rated Frequency: 50 or 60 Hz
Rated Power Consumption: 6 VA maximum

Meets the essential requirements of the following European Union Directives by using the relevant standards show below to indicate compliance.

89/336/EEC Electromagnetic Compatibility Directive
EN 61326:1997 With A1:1998 – Electrical equipment for measurement, control and laboratory use – EMC requirements (Industrial Immunity, Class A Emissions).

EN 61000-4-2:1996 With A1, 1998 – Electrostatic Discharge Immunity
EN 61000-4-3:1997 – Radiated Field Immunity
EN 61000-4-4:1995 – Electrical Fast-Transient / Burst Immunity
EN 61000-4-5:1995 With A1, 1996 – Surge Immunity
EN 61000-4-6:1996 – Conducted Immunity
EN 61000-4-11:1994 Voltage Dips, Short Interruptions and Voltage Variations Immunity
EN 61000-3-2:1995 With A1-3:1999 – Harmonic Current Emissions
EN 61000-3-3:1995 With A1:1998 – Voltage Fluctuations and Flicker

73/23/EEC Low-Voltage Directive
EN 61010-1:1993 With A1:1995 Safety Requirements of electrical equipment for measurement, control and laboratory use. Part 1: General requirements

déclare que le produit suivant : **Français**

Désignation : Série 935
Numéros de modèle : 935(A ou B) – 1C(C, D ou K)(0 ou 1) – (N'importe quelle combinaison de quatre lettres ou chiffres)
Classification : Régulation de température, Catégorie d'installation II, Degré de pollution II
Tension nominale : 100 à 240 V~ (c.a) ou 24 à 28 V ≈ (c.a ou c.c)
Fréquence nominale : 50 ou 60 Hz
Consommation d'alimentation nominale: 6 VA maximum

Répond aux normes essentielles des directives suivantes de l'Union européenne en utilisant les standards normalisés ci-dessous qui expliquent les normes auxquelles répondre :

Directive 89/336/CEE sur la compatibilité électromagnétique
EN 61326:1997 avec A1 :1998 – Matériel électrique destiné à l'étalonnage, au contrôle et à l'utilisation en laboratoire – Exigences CEM (Immunité industrielle, Émissions de catégorie A).

EN 61000-4-2:1996 Avec A1, 1998 – Immunité aux décharges électrostatiques
EN 61000-4-3:1997 – Immunité aux champs de radiation
EN 61000-4-4:1995 – Immunité contre les surtensions électriques rapides/ Rafale
EN 61000-4-5:1995 avec A1, 1996 – Immunité contre les surtensions
EN 61000-4-6:1996 – Immunité conduite
EN 61000-4-11:1994 Immunité contre les écarts de tension, interruptions courtes et variations de tension
EN 61000-3-2:1995 avec A1-3 :1999 – Émissions de courant harmoniques
EN 61000-3-3:1995 avec A1 :1998 – Fluctuations et vacillements de tension

Directive 73/23/CEE sur les basses tensions
EN 61010-1:1993 avec A1 :1995 Normes de sécurité du matériel électrique pour la mesure, le contrôle et l'utilisation en laboratoire. 1ère partie : Conditions générales

Erklärt, dass das folgende Produkt: **Deutsch**
Bezeichnung: Serie 935
Modell-Nummern: 935(A oder B) – 1C(C, D oder K)(0 oder 1) – (Beliebige vier Ziffern oder Buchstaben)
Klassifikation: Temperaturregler, Installationskategorie II, Verschmutzungsgrad II
Nennspannung: 100 bis 240 V~ (ac) oder 24 bis 28 V ≈ (AC oder DC)
Nennfrequenz: 50/60 Hz.
Nennstromverbrauch: 6 VA max.

Erfüllt die wichtigsten Normen der folgenden Anweisung(en) der Europäischen Union unter Verwendung des wichtigsten Abschnitts bzw. der wichtigsten Abschnitte die unten zur Befolgung aufgezeigt werden.

89/336/EEC Elektromagnetische Kompatibilitätsrichtlinie
EN 61326:1997 mit A1:1998 – Elektrisches Gerät für Messung, Kontrolle und Laborgebrauch – EMV-Anforderungen (Störfestigkeit Industriebereich, Klasse A Emissionen)

EN 61000-4-2:1996 mit A1, 1998 – Störfestigkeit gegen elektronische Entladung
EN 61000-4-3:1997 – Störfestigkeit gegen Strahlungsfelder
EN 61000-4-4:1995 – Störfestigkeit gegen schnelle Stöße/Burst
EN 61000-4-5:1995 mit A1, 1996 – Störfestigkeit gegen Überspannung
EN 61000-4-6:1996 – Geleitete Störfestigkeit
EN 61000-4-11:1994 Störfestigkeit gegen Spannungsabfall, kurze Unterbrechungen und Spannungsschwankungen
EN 61000-3-2:1995 mit A1-3:1999 – Harmonische Stromemissionen
EN 61000-3-3:1995 mit A1:1998 – Spannungsfuktationen und Flimmern

73/23/EEC Niederspannungsrichtlinie
EN 61010-1:1993 mit A1:1995 Sicherheitsanforderungen für elektrische Geräte für Messungen, Kontrolle und Laborgebrauch. Teil 1: Allgemeine Anforderungen

Declara que el producto siguiente: **Español**

Designación: Serie 935
Números de modelo: 935(A o B) – 1C(C, D o K)(0 o 1) – (Cualesquiera cuatro letras o números)
Clasificación: Control de temperatura, Categoría de instalación II, Grado de contaminación II
Voltaje nominal: 100 a 240 V~ (CA) o 24 a 28 V ≈(CA o CD)
Frecuencia nominal: 50 o 60 Hz
Consumo de energía nominal: 6 VA máximo

Cumple con los requisitos esenciales de las siguientes Directrices de la Unión Europea mediante el uso de las normas aplicables que se muestran a continuación para indicar su conformidad.

89/336/EEC Directriz de compatibilidad electromagnética
EN 61326:1997 CON A1:1998.– Equipo eléctrico para medición, control y uso en laboratorio – Requisitos EMC (Inmunidad industrial, Emisiones Clase A).

EN 61000-4-2:1996 con A1, 1998 – Inmunidad a descarga electrostática
EN 61000-4-3:1997 – Inmunidad a campo radiado
EN 61000-4-4:1995 – Inmunidad a incremento repentino/rápidas fluctuaciones eléctricas transitorias
EN 61000-4-5:1995 con A1, 1996 – Inmunidad a picos de voltaje o corriente
EN 61000-4-6:1996 – Inmunidad por conducción
EN 61000-4-11:1994 Inmunidad a caídas de voltaje, variaciones y pequeñas interrupciones de voltaje
EN 61000-3-2:1995 con A1-3:1999 – Emisiones de corriente armónica
EN 61000-3-3:1995 con A1:1998 – Fluctuaciones de voltaje y centelleo.

73/23/EEC Directriz de bajo voltaje
EN 61010-1:1993 con A1:1995 Requisitos de seguridad de equipo eléctrico para medición, control y uso en laboratorio. Parte 1: Requisitos generales

Jim Boigenzahn Winona, Minnesota, USA
Name of Authorized Representative Place of Issue
General Manager August, 2001
Title of Authorized Representative Date of Issue

Signature of Authorized Representative

Notes

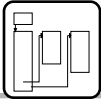

935A Software Map

Operations Menu

Prompt	Range	Default	Hidden if *	Your Settings
<input type="text" value="SP"/> Primary Set Point	<input type="text" value="rL"/> <input type="text" value="rH"/> Select a value, adjustable between Input Type Range Low and Input Type Range High.	75°F or 23°C	Appears always	
<input type="text" value="Aut"/> Auto-tune	<input type="text" value="no"/> <input type="text" value="YES"/> Choose YES to Auto-tune the 935A.	no	<input type="text" value="EA9"/> = <input type="text" value="A"/>	
<input type="text" value="AL0"/> Alarm Low	<input type="text" value="AHI"/> Select a value, adjustable between Range Low and Alarm High.	Type J Range Low	<input type="text" value="EA9"/> = <input type="text" value="0"/> ; or if <input type="text" value="OE1"/> and <input type="text" value="OE2"/> ≠ <input type="text" value="ALP7"/>	
<input type="text" value="AHI"/> Alarm High	<input type="text" value="rLO"/> Select a value, adjustable between Alarm Low and Range High.	Type J Range High	<input type="text" value="EA9"/> = <input type="text" value="0"/> ; or if <input type="text" value="OE1"/> and <input type="text" value="OE2"/> ≠ <input type="text" value="ALP7"/>	
<input type="text" value="EPT7"/> Countdown Timer	<input type="text" value="0000"/> Select a countdown time value, adjustable between 00:00 and 99:59 hrs:mins or min:sec.	0	<input type="text" value="EA9"/> = <input type="text" value="0"/> ; or if <input type="text" value="OE2"/> ≠ <input type="text" value="EhP7"/> or <input type="text" value="EPT5"/>	
<input type="text" value="idLE"/> Idle Set Point Type	<input type="text" value="ErAc"/> <input type="text" value="rL"/> <input type="text" value="rH"/> Choose an idle Set Point. Trac is an Idle Set Point equal to the Primary Set Point; or select a value between Input Type Range Low and Input Type Range High.	<input type="text" value="ErAc"/>	<input type="text" value="EA9"/> = <input type="text" value="0"/> ; or if <input type="text" value="OE2"/> ≠ <input type="text" value="EhP7"/> or <input type="text" value="EPT5"/>	

*NOTE:

All prompts, except and , are hidden if = .

Prompt	Range	Default	Hidden if *	Your Settings
L-r Local/Remote Set Point	<input type="text" value="L"/> <input type="text" value="r"/> Choose Local or Remote Set Point.	L	<input type="text" value="ERR"/> = <input type="text" value="0"/> ; or if <input type="text" value="DEL"/> ≠ <input type="text" value="rSP"/>	
Pid PID Menu	<input type="text" value="no"/> <input type="text" value="YES"/> Choose YES to move to the PID Menu.	no	<input type="text" value="ERR"/> = <input type="text" value="P"/>	
CONF Configuration Menu	<input type="text" value="no"/> <input type="text" value="YES"/> Choose YES to move to the Configuration Menu.	no	The front panel is locked out.	

Pb h Proportional Band Heat	<input type="text" value="0"/> <input type="text" value="999"/> <input type="text" value="0"/> <input type="text" value="555"/> <input type="text" value="0.0"/> <input type="text" value="999.0"/> <input type="text" value="0.0"/> <input type="text" value="555.0"/> Select a value in whole degrees (0°F to 999°F or 0°C to 555°C) or in tenths of degrees (0.0°F to 999.0°F or 0.0°C to 555.0°C).	25°F or 17°C	<input type="text" value="ERR"/> = <input type="text" value="P"/> ; or if <input type="text" value="DEL"/> and/or <input type="text" value="DEL"/> ≠ <input type="text" value="HERE"/>	
hYSh Hysteresis Heat	<input type="text" value="1"/> <input type="text" value="999"/> <input type="text" value="1"/> <input type="text" value="555"/> <input type="text" value="0.1"/> <input type="text" value="999.0"/> <input type="text" value="0.1"/> <input type="text" value="555.0"/> Select a value in whole degrees (1°F to 999°F or 1°C to 555°C) or in tenths of degrees (0.1°F to 999.0°F or 0.1°C to 555.0°C).	3°F or 2°C	<input type="text" value="ERR"/> = <input type="text" value="P"/> ; or if <input type="text" value="Pb h"/> ≠ 0	

Prompt	Range	Default	Hidden if *	Your Settings
ct h Cycle Time Heat	<input type="text" value="0.1"/> <input type="text" value="60.0"/> <input type="text" value="5.0"/> <input type="text" value="60.0"/> Select a value between 0.1 and 60.0 seconds (Solid-State Relay or Switched DC) or 5.0 and 60.0 seconds (Electromechanical Relay).	1.0 second	<input type="text" value="tR9"/> = <input type="text" value="P"/> or if <input type="text" value="Pb h"/> = 0	
<input type="text" value="db"/> Dead Band	<input type="text" value="0"/> <input type="text" value="999"/> <input type="text" value="0"/> <input type="text" value="555"/> <input type="text" value="0.0"/> <input type="text" value="999.0"/> <input type="text" value="0.0"/> <input type="text" value="555.0"/> Select a value in whole degrees (0°F to 999°F or 0°C to 555°C) or in tenths of degrees (0.0°F to 999.0°F or 0.0°C to 555.0°C).	0°F or 0°C	<input type="text" value="tR9"/> = <input type="text" value="P"/> or if <input type="text" value="DE1"/> = <input type="text" value="cool"/> and <input type="text" value="DE2"/> ≠ <input type="text" value="HERE"/> or if <input type="text" value="DE1"/> = <input type="text" value="HERE"/> and <input type="text" value="DE2"/> ≠ <input type="text" value="cool"/>	
<input type="text" value="Pb c"/> Proportional Band Cool	<input type="text" value="0"/> <input type="text" value="999"/> <input type="text" value="0"/> <input type="text" value="555"/> <input type="text" value="0.0"/> <input type="text" value="999.0"/> <input type="text" value="0.0"/> <input type="text" value="555.0"/> Select a value in whole degrees (0°F to 999°F or 0°C to 555°C) or in tenths of degrees (0.0°F to 999.0°F or 0.0°C to 555.0°C).	25°F or 17°C	<input type="text" value="tR9"/> = <input type="text" value="P"/> or if <input type="text" value="DE1"/> ≠ <input type="text" value="cool"/> and/or <input type="text" value="DE2"/> ≠ <input type="text" value="cool"/>	
<input type="text" value="hysc"/> Hysteresis Cool	<input type="text" value="1"/> <input type="text" value="999"/> <input type="text" value="1"/> <input type="text" value="555"/> <input type="text" value="0.1"/> <input type="text" value="999.0"/> <input type="text" value="0.1"/> <input type="text" value="555.0"/> Select a value in whole degrees (1°F to 999°F or 1°C to 555°C) or in tenths of degrees (0.1°F to 999.0°F or 0.1°C to 555.0°C).	3°F or 2°C	<input type="text" value="tR9"/> = <input type="text" value="P"/> or if <input type="text" value="Pb c"/> ≠ 0	

Prompt	Range	Default	Hidden if *	Your Settings
<p>CT c</p> <p>Cycle Time Cool</p>	<p>0.1 60.0</p> <p>5.0 60.0</p> <p>Select a value between 0.1 and 60.0 seconds (Solid-State Relay or Switched DC) or 5.0 and 60.0 seconds (Electromechanical Relay).</p>	5.0 seconds	<p>LAG = P;</p> <p>or if</p> <p>Pb c = 0</p> <p>or if</p> <p>Pb c is hidden</p>	
<p>IT</p> <p>Integral Function</p>	<p>0.0 99.99</p> <p>Select a value, adjustable between 0.0 and 99.99 minutes/repeat.</p>	5.00 minutes/repeat	<p>LAG = P;</p> <p>or if</p> <p>Pb h = 0;</p> <p>or if</p> <p>Pb h is hidden; and if Pb c = 0;</p> <p>or if</p> <p>Pb c is hidden</p>	
<p>dE</p> <p>Derivative Function</p>	<p>0.00 9.99</p> <p>Select a value, adjustable between 0.00 and 9.99 minutes.</p>	0 minutes	<p>LAG = P;</p> <p>or if</p> <p>Pb h = 0;</p> <p>or if</p> <p>Pb h is hidden; and if Pb c = 0;</p> <p>or if</p> <p>Pb c is hidden</p>	
<p>CAL</p> <p>Calibration Offset</p>	<p>-999 9999</p> <p>-99.9 999.9</p> <p>Select a value, adjustable between -999° and 9999°F or C or -99.9° and 999.9°F or C to eliminate a difference between the displayed temperature and the actual temperature.</p>	0°F or 0°C	<p>LAG = P</p>	

Prompt	Range	Default	Hidden if *	Your Settings
<input type="text" value="In"/> Input Type	<input type="text" value="J"/> J t/c <input type="text" value="H"/> K t/c <input type="text" value="E"/> T t/c <input type="text" value="N"/> N t/c <input type="text" value="E"/> E t/c <input type="text" value="S"/> S t/c <input type="text" value="rtd"/> 1.0°RTD <input type="text" value="rtd"/> 0.1°RTD	J	<input type="text" value="LR9"/> = <input type="text" value="C"/>	
<input type="text" value="C_F"/> Celsius/Fahrenheit	<input type="text" value="oF"/> <input type="text" value="oC"/> Choose to indicate temperature in °Fahrenheit or °Celsius.	F	<input type="text" value="LR9"/> = <input type="text" value="C"/>	
<input type="text" value="rL"/> Range Low	<input type="text" value="In"/> <input type="text" value="rh"/> Select a value between Input Type Range Low and Input Range High.	Type J range low value	<input type="text" value="LR9"/> = <input type="text" value="C"/>	
<input type="text" value="rh"/> Range High	<input type="text" value="rL"/> <input type="text" value="In"/> Select a value between Input Type Range High and Input Range Low.	Type J range high value	<input type="text" value="LR9"/> = <input type="text" value="C"/>	
<input type="text" value="OEt"/> Output 1 Function	<input type="text" value="HEAT"/> <input type="text" value="COOL"/> <input type="text" value="ALPN"/> <input type="text" value="rSP"/> <input type="text" value="FPL"/> <input type="text" value="nonE"/> Choose Heat, Cool, Alarm, Remote Set Point, Front Panel Lock or No output action.	heat	<input type="text" value="LR9"/> = <input type="text" value="C"/>	

Prompt	Range	Default	Hidden if *	Your Settings
DEL2 Output 2 Function	HEAT COOL ALARM THERM TIMER NONE Choose Heat, Cool, Alarm, Timer (Hrs:Min), Timer (Min:Sec) or No output action.	none	TAG = C	
DISP Display Default	Ac ACSP ACT1 IAc DISP Choose the primary (last 2 characters) and secondary (first 2 characters) Default displays. Press SET to toggle to the secondary display for 15 seconds.	Ac	TAG = C	
ALTY Alarm Type	Prnc Prnc DEnc DEnc Choose an alarm type: Process normally closed, Process normally open, Deviation normally closed or Deviation normally open.	Prnc	TAG = C ; or if DEL1 and/or DEL2 ≠ ALARM	
ALYS Alarm Hysteresis	1 999 1 555 0.1 999.0 0.1 555.0 Select a value in whole degrees (1°F to 999°F or 1°C to 555°C) or in tenths of degrees (0.1°F to 999.0°F or 0.1°C to 555.0°C).	3°F or 2°C	TAG = C ; or if DEL1 and/or DEL2 ≠ ALARM	

Prompt	Range	Default	Hidden if *	Your Settings
<input type="checkbox"/> LAL Alarm Latch	<input type="checkbox"/> no <input type="checkbox"/> YES Choose YES for a Latching Alarm.	no	<input type="checkbox"/> LAG = <input type="checkbox"/> C ; or if <input type="checkbox"/> OE1 and/or <input type="checkbox"/> OE2 ≠ ALPN	
<input type="checkbox"/> SIL Alarm Silencing	<input type="checkbox"/> no <input type="checkbox"/> YES Choose YES for a Silenced Alarm on start-up or silencing during operation.	no	<input type="checkbox"/> LAG = <input type="checkbox"/> C ; or if <input type="checkbox"/> OE1 and/or <input type="checkbox"/> OE2 ≠ ALPN	
<input type="checkbox"/> FAIL Input Failure Mode	<input type="checkbox"/> bPLS <input type="checkbox"/> -100 <input type="checkbox"/> 100 Choose Bumpless Transfer or Percent Power.	Bumpless	<input type="checkbox"/> LAG = <input type="checkbox"/> C ; or if <input type="checkbox"/> OE1 and <input type="checkbox"/> OE2 ≠ HERE or COOL	
<input type="checkbox"/> LOPN Timer Output Function	<input type="checkbox"/> dLoN <input type="checkbox"/> dLoF <input type="checkbox"/> S9oN <input type="checkbox"/> S9oF Choose Delay ON, Delay OFF, Signal ON, or Signal OFF.	Delay OFF	<input type="checkbox"/> LAG = <input type="checkbox"/> C ; or if <input type="checkbox"/> OE2 ≠ LOPN or LOFS	
<input type="checkbox"/> STRT Start Timer Function	<input type="checkbox"/> IPND <input type="checkbox"/> rdy <input type="checkbox"/> rdYA <input type="checkbox"/> PLJr Choose Immediate, Ready Band, Ready Band Acknowledge, or Power.	Immediate	<input type="checkbox"/> LAG = <input type="checkbox"/> C ; or if <input type="checkbox"/> OE2 ≠ LOPN or LOFS	
<input type="checkbox"/> rdy Timer Ready Band	<input type="checkbox"/> 0 <input type="checkbox"/> 999 <input type="checkbox"/> 0 <input type="checkbox"/> 555 <input type="checkbox"/> 0.0 <input type="checkbox"/> 999.0 <input type="checkbox"/> 0.0 <input type="checkbox"/> 555.0 If <input type="checkbox"/> STRT = <input type="checkbox"/> rdYA or <input type="checkbox"/> rdy , then select a value in whole degrees (0°F to 999°F or 0°C to 555°C) or in tenths of degrees (0.0°F to 999.0°F or 0.0°C to 555.0°C).	0°F or 0°C	<input type="checkbox"/> LAG = <input type="checkbox"/> C ; or if <input type="checkbox"/> OE2 ≠ LOPN or LOFS	

Prompt	Range	Default	Hidden if *	Your Settings
<input type="text" value="SE"/> Signal Time	<input type="text" value="1 99 9"/> If <input type="text" value="E 1P7"/> = <input type="text" value="59on"/> or <input type="text" value="59oF"/> , then select a value between 00:01 and 99:59 min:sec.	00:01	<input type="text" value="E A9"/> = <input type="text" value="C"/> ; or if <input type="text" value="E 1P7"/> ≠ <input type="text" value="59on"/> or <input type="text" value="59oF"/>	
<input type="text" value="SLOC"/> Set Point Lockout	<input type="text" value="no"/> <input type="text" value="YES"/> Choose YES to Lock the Primary Set Point.	no	<input type="text" value="E A9"/> = <input type="text" value="C"/>	
<input type="text" value="E A9"/> Lockout Tag	<input type="text" value="PCOR"/> <input type="text" value="COR"/> <input type="text" value="PCO"/> <input type="text" value="CO"/> <input type="text" value="PC A"/> <input type="text" value="C A"/> <input type="text" value="PC"/> <input type="text" value="C"/> <input type="text" value="P OR"/> <input type="text" value="OR"/> <input type="text" value="P O"/> <input type="text" value="O"/> <input type="text" value="P A"/> <input type="text" value="A"/> <input type="text" value="P"/> <input type="text" value=""/> Choose the menus/functions that will not be displayed, and therefore cannot be changed. P = PID Menu C = Configuration Menu (except tag) O = Operations Menu (except <input type="text" value="C nF9"/>) A = Auto-tune	P	Always appears	

Notes

Notes

About Watlow Winona

Watlow Winona is a U.S. division of Watlow Electric Manufacturing Company, St. Louis, Missouri, a manufacturer of industrial electric heating products since 1922. Watlow products include electric heaters, sensors, controllers and switching devices. The Winona operation has been designing solid-state electronic control devices since 1962, and has earned the reputation as an excellent supplier to original equipment manufacturers. These OEMs and end users depend upon Watlow Winona to provide compatibly engineered controls that they can incorporate into their products with confidence. Watlow Winona resides in a 100,000-square-foot marketing, engineering and manufacturing facility in Winona, Minnesota.

Warranty

The Watlow Series 935 is warranted to be free of defects in material and workmanship for 36 months after delivery to the first purchaser for use, providing that the units have not been misapplied. Since Watlow has no control over their use, and sometimes misuse, we cannot guarantee against failure. Watlow's obligations hereunder, at Watlow's option, are limited to replacement, repair or refund of purchase price, and parts which upon examination prove to be defective within the warranty period specified. This warranty does not apply to damage resulting from transportation, alteration, misuse, or abuse.

Returns

- Call or fax your distributor or the nearest Watlow sales office for best information about returns. (See outside back cover.)
- To return directly to Watlow Winona in the U.S., first call or fax Customer Service for a Return Material Authorization (RMA) number (telephone: +1 (507) 454-5300; fax: +1 (507) 452-4507).
- Put the RMA number on the shipping label, along with on a written description of the problem.
- A restocking charge of 20% of the net price is charged for all standard units returned to stock.

How to Reach Us



Quality and Mission Statement:

Watlow Winona will be the world's best supplier of superior measurement and control products, services, and systems, by exceeding the expectations of our customers, shareholders, and employees.

Your Authorized Watlow Distributor:

Europe:

Watlow GmbH
Industriegebiet Heidig
Lauchwasenstr. 1, Postfach 1165,
Kronau 76709 Germany
Telephone: +49 7253-9400 0
Fax: +49 7253-9400 44

Watlow France S.A.R.L.
Immeuble Somag, 16 Rue Ampère,
Cergy Pontoise CEDEX 95307 France
Telephone: +33 (1) 3073-2425
Fax: +33 (1) 3073-2875

Watlow Italy S.R.L.
Via Meucci 14
20094 Corsico MI
Italy
Telephone: +39 (02) 4588841
Fax: +39 (02) 458-69954

Watlow Limited
Robey Close, Linby Industrial Estate,
Linby Nottingham England, NG15 8AA
Telephone: +44 (0) 115 9640777
Fax: +44 (0) 115 9640071

Latin America:

Watlow de México
Av. Fundación #5,
Col. Parques Industriales,
Querétaro, Qro. México CP-76130
Telephone: +52 (442) 217-6235
Fax: +52 (442) 217-6403

Asia/Pacific:

Watlow Australia Pty., Ltd.
23 Gladstone Park Drive,
Tullamarine, Victoria 3043 Australia
Telephone: +61 (39) 335-6449
Fax: +61 (39)330-3566

Watlow China, Inc.
179, Zhong Shan Xi Road
Hong Qiao Cointek Bldg, Fl. 4, Unit P
Shanghai 200051 China
Telephone: +86 (21) 6229-8917
Fax: +86 (21) 6228-4654

Watlow Japan Ltd. K.K.
Azabu Embassy Heights 106,
1-11-12 Akasaka,
Minato-ku, Tokyo 107-0052 Japan
Telephone: +81 (03) 5403-4688
Fax: +81 (03) 5403-4646

Watlow Korea Co., Ltd.
Hanil Bldg., 3rd Floor
210-5 Yangje-Dong Seocho-Gu
Seoul, 137-130 Korea
Telephone: +82 (2) 575-9804
Fax: +82 (2) 575-9831

Watlow Malaysia Sdn Bhd
38B Jalan Tun Dr Awang
11900 Bayan Lepas
Penang Malaysia
Telephone: +60 (4) 641-5977
Fax: +60 (4) 641-5979

Watlow Singapore Pte. Ltd.
Ayer Rajah Crescent
#03-23 Ayer Rajah Industrial Estate
Singapore 139949
Telephone: +65 773 9488
Fax: +65 778 0323

Watlow Electric Taiwan
10F-1 No. 189
Chi-Shen 2nd Road,
Kaohsiung, Taiwan
Telephone: +886 (7) 288-5168
Fax: +886 (7) 288-5568