



Glow-worm

Instructions for Use

Ultracom₂ 35 Store

G.C. No. 47-019-15

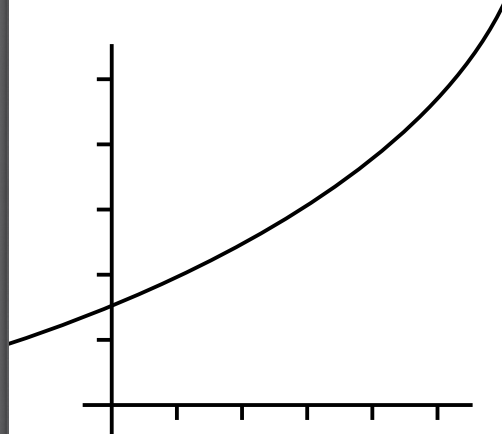

TABLE OF CONTENTS

READ CAREFULLY BEFORE USING

1	Read me	3
	1.1 Welcome	3
	1.2 Guarantee Pack	3
	1.3 Servicing	3
	1.4 Benchmark.....	4
	1.5 Quick reference guide.....	4
2	Introducing your appliance	5
	2.1 Appliance description	5
	2.2 Accessories.....	5
3	Product documentation	6
	3.1 Document storage	6
	3.2 Explanation of symbols.....	6
4	Safety	6
	4.1 What to do if you smell gas?	6
	4.2 Safety recommendations	6
	4.3 Safety regulations	7
5	Guarantee / Responsibility	8
	5.1 Detailed guarantee	8
	5.2 Appliance use / manufacturer responsibility	8
6	Recycling.....	9
	6.1 Appliance	9
	6.2 Packaging.....	9
7	Clearances.....	9

HOW TO USE YOUR APPLIANCE

8	Overview	10
	8.1 Display	10
	8.2 Switching On.....	11
	8.3 Turning off	11
	8.4 Description of control panel indicators.....	11
	8.5 User Controls	11

TABLE OF CONTENTS

ANY ASSISTANCE?

9	Fault Finding.....	13
10	Appliance safety devices.....	14
	10.1 Boiler Shutdown.....	14
	10.2 Protecting against frost.....	14
	10.3 Condensate Drain Blockage.....	14
	10.4 Safety Discharge Valve.....	14
11	Appliance maintenance and servicing.....	15
	11.1 Cleaning	15
	11.2 Regular servicing.....	15
	11.3 Spare Parts	15
	11.4 Sealed Water Systems	15
12	Tips for saving energy.....	16
13	Contact your after-sales organisation	16

READ CAREFULLY BEFORE USING**1 Read me****1.1 Welcome**

These instructions are an integral part of the boiler and must, to comply with the current issue of the Gas Safety (Installation and Use) Regulations, be left with the user.

Please ensure that the installer has fully completed the Benchmark Checklist in the rear pages of the installation instructions supplied with the product and that you have signed it to say that you have received a full and clear explanation of its operation. The installer is legally required to complete a commissioning checklist as a means of complying with the appropriate Building Regulations (England and Wales).

All installations must be notified to Local Area Building Control either directly or through a Competent Persons Scheme. A Building Regulations Compliance Certificate will then be issued to the customer who should, on receipt, write the Notification Number on the Benchmark Checklist.

- Please read these instructions and follow them carefully for the safe and economical use of your boiler.



Do not forget to read the chapters "Safety" and "Guarantee" where you will find important information for your safety.

1.2 Guarantee Pack

The pack contains the letter of introduction and the guarantee. The extended guarantee is supplied loose and we recommend that you should read it.

- Complete and return as soon as possible your guarantee registration card.

If your guarantee registration card is missing you can obtain a copy or record your registration by telephoning the Glow-worm Customer Service number 0800 073 2142.

1.3 Servicing

This product should be serviced regularly to optimise its safety, efficiency and performance. The service engineer should complete the relevant Service Record on the Benchmark Checklist after each service. The Benchmark Checklist may be required in the event of any warranty work and as supporting documentation relating to home improvements in the optional documents section of the Home Information Pack.

To ensure the continued efficient and safe operation of the boiler it is recommended that it is checked and serviced at regular intervals. The frequency of servicing will depend upon the site conditions and usage, but in general, once a year should be enough.

- To obtain service, please call your installer or Glow-worm's own service organisation.

1.4 Benchmark

Glow-worm is a licensed member of the Benchmark Scheme which aims to improve the standards of installation and commissioning of domestic heating and hot water systems in the UK and to encourage regular servicing to optimise safety, efficiency and performance.

Benchmark is managed and promoted by the Heating and Hotwater Industry Council.













- For more information visit www.centralheating.co.uk

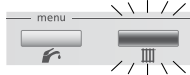
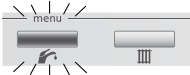
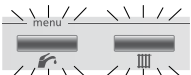

1.5 Quick reference guide

We designed this Quick reference guide so that you can start using your appliance right away.

This Quick reference guide assumes that the appliance have been installed and commissioned by a competent person.

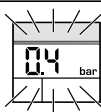
  ON / OFF		Green: appliance on
 Burner Operation		Yellow: burner operation
<p>Hot water Temperature controls</p>  <p style="text-align: center;">Domestic Hot water Function Button/Indicator</p> <p>ECO function  >3s</p>	<p>Heating Temperature controls</p>  <p style="text-align: center;">Central Heating Function Button/Indicator</p>	
 <p>Heating only</p>	 <p>Domestic Hot Water only</p>	 <p>Heating + Domestic Hot Water</p>
<p>Reset Symbol Displayed</p>   <p>Flash red: fault</p> <p>Press the reset button. If the appliance fails to reset and the CF0xx symbol displays, a further 2 attempts may be made. If fault persists, contact your installer or service provider.</p>	<p>Lack of water Symbol </p>  <p>If the CH pressure falls below 0.4 bar the display will flash the current pressure and the boiler will not operate. Contact your installer/service provider.</p>	

If the central heating (C.H.) pressure falls below 0.4 bar the display will flash the current pressure and below 0.3 bar the boiler will not operate, refer to fault finding section.

2 Introducing your appliance

2.1 Appliance description

The Ultracom₂ 35 Store is designed to provide central heating and instantaneous hot water. The pump, expansion vessel, storage tank and associated safety devices are all fitted within the boiler.

Intelligent controls are available as accessories from Glow-worm.

Contact your Installer or Glow-worm sales for further information.

The Ultracom₂ 35 Store boiler is an appliance that uses condensing technology, which recovers heat from the flue gases, this operating principle, consumes less energy and contributes to the reduction of your household CO₂ emissions.

This appliance is a room-sealed type equipped with a flue system for air supply and the removal of combustion products. This flue system offers the possibility to install the appliance in any room without the need for additional ventilation.

Installation and commissioning of the appliance should only be carried out by a competent person. They are responsible for the installation and the commissioning in accordance with standards in force.

You should also consult a competent person for maintenance and repair of the appliance as well as for any adjustment necessary.

The Energy Saving Trust Recommended logo

Only the most energy efficient products carry the Energy Saving Trust Recommended logo, making it a quick and easy way for you to identify products that have met the strictest criteria on energy efficiency. These products will cost you

less to run, contribute towards savings on your energy bills and help reduce carbon emissions.

The criteria is set by an independent panel and reviewed annually. In addition, the Energy Saving Trust tests a percentage of products every year, so you can rest assured that where there's a logo there's a smarter choice.

When you are purchasing a new product all you need to remember is to look for the Energy Saving Trust Recommended logo. For more information visit energysavingtrust.org.uk

The Energy Saving Trust

The Energy Saving Trust is a non-profit organisation that provides free, impartial advice tailored to help you save money and fight climate change by reducing carbon dioxide emissions from your home. Call 0800 512 012 for more information or visit energysavingtrust.org.uk



Certification mark

2.2 Accessories

For increased system compatibility and increased energy saving with intelligent control Glow-worm offer a range of controls dedicated to work using a unique communication system - eBus.

- For further details please contact your installer.

3 Product documentation

3.1 Document storage

- Make sure that this manual is stored close to your appliance for future reference. Should you move home ensure that this manual is close to this appliance for future reference by the new home owners.
- Read these instructions and follow them carefully for the safe and efficient use of your appliance.

No responsibility or liability can be accepted for damages caused by failure to follow the instructions in this manual.

3.2 Explanation of symbols



DANGER: Risk of injuries.



ATTENTION: Risk of damage to the appliance or to its surroundings.



IMPORTANT INFORMATION

4 Safety

4.1 What to do if you smell gas?

- isolate your gas supply at the gas emergency control valve.
- Eliminate all sources of ignition, i.e. smoking, blowlamps, hot air guns etc.
- do not operate electrical lights or switches, either on or off. Open all doors and windows, ventilate the area.
- open immediately windows and doors in order to ventilate the property.

- do not search for gas leaks with a naked flame.

- [call the gas suppliers emergency phone number: 0800 111 999](tel:0800111999)

- alert other building occupants.

4.2 Safety recommendations

You must comply with the following recommendations and safety instructions:

- Never perform any maintenance or repair of the appliance yourself. Only competent persons are allowed to work on the appliance.
- Never tamper with safety devices.
- Do not attempt to modify the appliance or its immediate surroundings as this may affect on the safe use of the appliance.
- Under no circumstances must the user interfere with or adjust sealed parts.
- Do not allow children to operate the appliance.
- Do not obstruct the flue system

Certain home improvements may adversely affect the operation of your appliance – you should consult your installer for advice before carrying out any work.

- Do not expose the appliance to high humidity.
- Do not use or store explosive or inflammable materials (e.g. petrol, aerosols, solvents, chlorine based detergents, paint, glue etc.) in the same room as the appliance. Under certain conditions, these substances can prove to be corrosive.
- Do not touch the heated surfaces of the appliance, such as outlet duct, hydraulic

connections, also after the appliance operation because, for a certain time, these surfaces may become hot. Any contact with them can cause burns.

- The hot water delivered by the appliance can be very hot. The appliance hot water temperature can be adjustable to suit your specific needs as part of the commissioning. Particular care must be taken should the system be used by young children, the very old and those with sensory loss. In these instances lower distribution temperatures should be used or the system protected by a tempering valve.

This appliance contains metal parts (components) and care should be taken when handling and cleaning, with particular regard to edges.

- In the case of any water leak, immediately turn off the cold water supply to the appliance and have the leak repaired by your competent person.
- Do not store or place articles on the appliance.

4.3 Safety regulations

Servicing/maintenance should be carried out by a **competent person** approved at the time by the Health and Safety Executive, in accordance with the rules in force in the countries of destination.

If this boiler is installed in a rented property in the UK there is a duty of care imposed on the owner of the property by the current issue of the Gas Safety (Installation and Use) Regulations, Section 35.

Gas Safety (Installation and Use) Regulations

In your own interests and that of safety, it is the Law that ALL gas appliances have been installed by a competent person approved

at the time by the Health and Safety Executive, in accordance with the current issue of these regulations.

Gas Category

This boiler is for use only on G20 natural gas but can be converted for use on G31 propane.

Electrical Connection

The boiler **MUST** be earthed.

The boiler **MUST** be connected to a permanent 230V ac, 50Hz supply, fused at 3A.

Connection of the whole electrical system of the boiler, including any heating controls, to the electrical supply must be through one common isolator.

The colours of three core flexible cable are, blue - neutral, brown - live, green and yellow - earth.

Testing and Certification

This boiler is certificated to the current issue of EN 483 for performance and safety.

It is important that no alteration is made to the boiler unless approved, in writing, by Glow-worm.

Any alteration not approved by Glow-worm, could invalidate the certification, boiler warranty and may also infringe the current issue of the statutory requirements.

CE Mark

This boiler meets the requirements of Statutory Instrument, No.3083 of the Boiler (Efficiency Regulations, and therefore is deemed to meet the requirements of Directive 92/42/EEC on the efficiency requirements for new hot water boilers fire with liquid or gaseous fuels.

Type test for purposes of Regulation 5 certified by: Notified body 1312.

Product/production certified by: Notified body 0086.

The CE mark on this appliance shows compliance with:

- Directive 2009/142/EEC on the approximation of the laws of the Member States relating to appliances burning gaseous fuels.
- Directive 2006/95/EEC on the harmonisation of the Laws of the Member States relating to electrical equipment designed for use within certain voltage limits.
- Directive 2004/108/EEC on the approximation of the Laws of the Member States relating to electromagnetic compatibility.



The CE mark shows that this appliance has been designed according to the safety techniques and rules in force. The compliance of this appliance with the relevant standards has been certified.

5 Guarantee / Responsibility

5.1 Detailed guarantee

Thank you for installing a new Glow-worm appliance in your home.

Glow-worm appliances are manufactured to the very highest standard so we are pleased to offer our customers a Comprehensive Guarantee.

This product is guaranteed for 24 months from the date of installation or 30 months from the date of manufacture, whichever is the shorter, for parts and labour.

The second year of the parts guarantee, from the beginning of the 13th month onwards after installation or manufacture, is conditional upon the boiler having been serviced by a competent person approved at the time by the Health and Safety Executive, in accordance with the manufacturer's recommendations. We strongly recommend regular servicing of your gas appliance, but where the condition is not met, any chargeable spare parts or components issued within the applicable guarantee period still benefit from a 12 month warranty from the date of issue by the manufacturer.

5.2 Appliance use / manufacturer responsibility

Servicing/maintenance should be carried out by a competent person approved at the time by the Health and Safety Executive, in accordance with the rules in force in the countries of destination.

The guarantee is applicable on the condition that:

- The appliance is installed by a competent person in accordance with installation instructions.
- The appliance is used for normal domestic purposes and in accordance with the manufacturer's operating and maintenance instructions.
- The appliance is serviced, maintained, by a competent person.
- The repair or replacement of parts during the guarantee period does not have the effect of extending the period.

The manufacturer has no responsibility whatsoever for any damage resulting from:

- Any defects or damage resulting from incorrect or poor installation,

inadequate servicing, or maladjustment of the gas or water used.

- Any defects in the system to which the appliance is connected.
- Any defects caused by inadequate frost protection.
- Any deterioration or maladjustment following changes in the nature or pressure of the gas or the water used, or a change in the characteristics of the electrical supply voltage.
- For further details, refer to your Terms and Conditions.



This appliance is intended to be installed only within the designated countries displayed on the type plate.

- It is the responsibility of parents, guardians and carers, that the appliance is protected away from persons under their care.

6 Recycling

This appliance contains many recyclable parts and should be disposed of according to the current regulations. The packaging should also be disposed of according to the current regulations.

6.1 Appliance



This symbol indicates that this appliance must not be disposed of with household waste, that it should be selectively collected for energy recovery, reuse or recycling.

- Take the appliance to an appropriate collection point.



By complying with this directive, you will contribute to the preservation of natural resources and the protection of human health.

6.2 Packaging

The competent person who installed the appliance must:

- sort the waste so as to separate those which can be recycled (cardboard, plastics...) from those that cannot.
- dispose of the waste in compliance with regulations in force.

7 Clearances

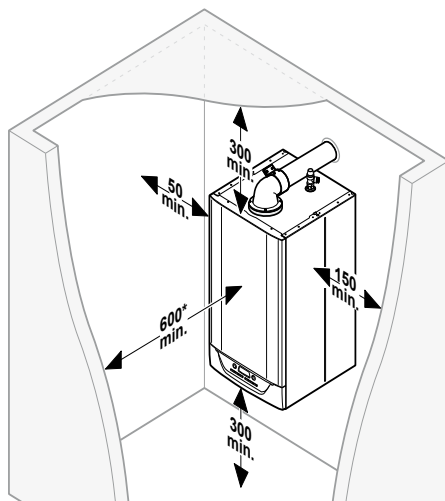

NOTE:

- * A removable compartment door can be placed a minimum 5 mm in front of appliance. A clearance of 600 mm is required from a fixed surface.

HOW TO USE YOUR APPLIANCE

8 Overview

8.1 Display

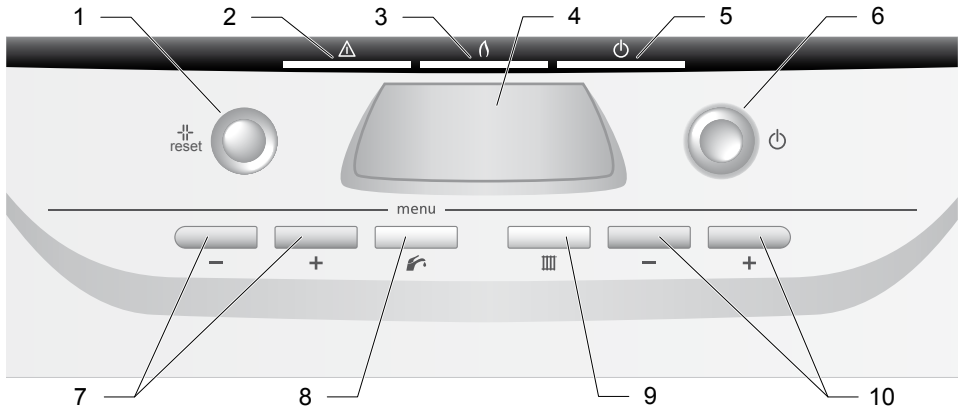

Key

- | | | | |
|---|---|----|--|
| 1 | Reset button | 8 | Domestic hot water function Button/Indicator |
| 2 | Fault indicator red LED | 9 | Central heating function Button/Indicator |
| 3 | Burner working indicator orange LED | 10 | Central heating temperature controls |
| 4 | Display | | |
| 5 | Appliance on indicator green LED | | |
| 6 | On/Off button | | |
| 7 | Domestic hot water temperature controls | | |

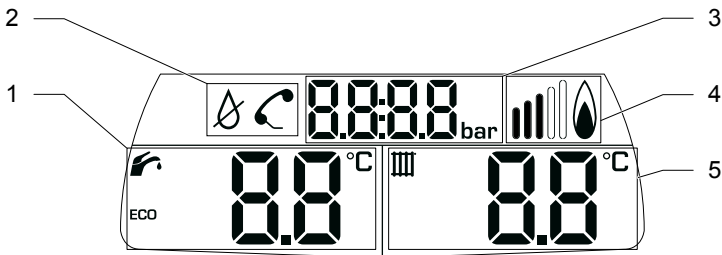

Key

- | | | | |
|---|---------------------------------|---|-----------------------------|
| 1 | Domestic hot water temperature | 4 | Burner operating indicator |
| 2 | Fault symbols | 5 | Central heating temperature |
| 3 | Central heating system pressure | | |

8.2 Switching On

Check that all isolating valves and the gas service cock on the appliance are open and that water flows from the hot water taps, close the taps.



Do not operate the boiler without water.

- Make sure that:
 - The appliance has electrical power,
 - The gas service cock is open
 - The mains water supply is turned on



If you are in any doubt about the boiler being filled with water contact your installer or Glow-worm's own service organisation using the telephone number shown in the chapter "Contact your after-sales organisation".

- Press the on/off button (6).

The control panel display turns on. After an initialisation cycle lasting a few seconds, the appliance is ready for use.

8.3 Turning off

- Press the on/off button (6).

The appliance is no longer powered and the display switches off.



If you intend to leave your property empty for a prolonged period, please refer to the Appliance Safety Devices section.

8.4 Description of control panel indicators

Working indicator	Steady green: appliance on
Burner on indicator	Steady yellow: burner working
Fault indicator	Flashing red: fault signal (see "Fault diagnosis" chapter)

8.5 User Controls

8.5.1 Selection of operating mode(s)

After each start-up, the appliance starts in "heating + hot water" mode.

To change the operating mode:

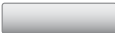
- Press the button  on the side to activate or deactivate the Hot Water mode.
- Press the button  on the side to activate or deactivate Heating mode.
 - Mode activated
 - ▶ the button lights up. White LED.
 - Mode deactivated
 - ▶ the button is not lit.

Heating + domestic hot water	
Heating only	
Domestic Hot water only	

- When **ECO** is not displayed the keep hot facility is activated
- The **ECO** mode corresponds to a minimum temperature for water storage in the tank. When it is reached, reheating starts automatically. This mode is used to reduce the number of times the tank is heated and thus the number of boiler start-ups.



IMPORTANT: The Climapro₂ RF can be used to time the keep hot facility.



IMPORTANT: When neither of the symbols are displayed, the boiler is in frost-protection mode.

8.5.2 Adjusting the domestic hot water temperature

- Press the buttons \oplus or \ominus of the function to adjust the temperature of domestic hot water.

	Temperature of the water (°C)
min.	45
recommended	50
max.	65

Keep hot facility function:

- Hold down the buttons \oplus and \ominus of the function to deactivate the **ECO** function.
- When **ECO** is displayed the keep hot facility is deactivated

8.5.3 Adjustment for the water temperature in the heating circuit

- Press the buttons \oplus or \ominus of the function to adjust the temperature of the water in the heating circuit.

	Temperature of the water (°C)
min.	10
recommended	50
max.	Pre-set by the installer

NOTE: If a Glow-worm outdoor sensor or Glow-worm intelligent controls are fitted, the temperature of the water in the heating circuit is calculated by the boiler.

- It is neither necessary nor possible to adjust it manually.
- Press briefly the buttons \oplus or \ominus of the function show the value of this temperature.

ANY ASSISTANCE?





9 Fault Finding

In this section fault codes that are displayed, which CAN be carried out by the USER to restore appliance operation (Corrective action: ...). Other fault codes MUST be solved by a competent person only.

- If after carrying out this basic advice and your appliance still does not work, leave it turned off and contact your competent person.



Like all condensing boilers it will produce a plume of condensation from the flue terminal in cool weather. This is due to the high efficiency and hence low flue gas temperature of the boiler. It is normal and not a fault indication.

Fault code	Possible causes	Solution
The appliance stops working	Electrical circuit interrupted	Check that there is no power cut and that the appliance is correctly connected. When electrical power comes back on, the appliance automatically comes back into service. If the fault persists, contact your Installation/Service company or Glow-worm Service.
	Fault	Press on the "reset" button. Wait for 5 seconds. If the fault persists and the symbol  appears, contact your Installation/Service company or Glow-worm Service.
	Lack of water in the installation (< 0.5 bars)	Open the filling tap located under the appliance until you obtain a pressure of between 0.8 and 1.2 bars on the indicator, refer to diagram overleaf. If refilling needs to be carried out too often, there may be a leak in your installation. In this case, contact your Installation/Service company or Glow-worm Service, to have your system checked.
	Excess water in the installation	With central heating off, open the vent (bleed screw) on a radiator to allow water to escape and reduce the pressure in the heating circuit, or contact your Installation/Service company or Glow-worm Service.
	Fault	Contact your Installation/Service company or Glow-worm Service.

10 Appliance safety devices

10.1 Boiler Shutdown

The boiler software is designed to recognise the potential for an overheat lockout and will shutdown before this happens.

- To restart the boiler, press the reset button, see chapter «Appliance use ▶ Overview».

If the boiler fails to resume normal operation and all external controls are calling for heat, then call your Installation/ Servicing company or Glow-worm service.

10.2 Protecting against frost

Appliance Protection

In case of the risk of frost:

- Make sure that the electrical and gas supply to the appliance is turned on.
- For an absence of several days, select the «frost protection» mode. In this mode, only the water pressure in the heating circuit is visible.

or

- Set the «holiday» mode in the external control.

The frost-protection system starts the appliance's pump when the temperature in the heating circuit goes below 12°C. The pump stops when the temperature of the water in the heating circuit reaches 15°C. If the temperature in the heating circuit goes below 7°C, the burner is lit until the temperature reaches 35°C.

If the boiler is in «Domestic Hot Water» mode only, the frost-protection system is also active.

System Protection

The boiler alone cannot ensure that the installation is protected against frost.

NOTE: Any other exposed areas of the system should be protected by a separate frost thermostat.

In case of prolonged absence, where power to the dwelling and the boiler is switched off, contact your Installation/ Servicing company or Glow-worm Service to have the installation drained or to have the heating circuit protected by adding an anti-freeze specially designed for heating systems.



CAUTION: *Your domestic water circuit (hot and cold) is not protected by the boiler.*

10.3 Condensate Drain Blockage

As a safety feature the boiler will stop working if the condensate drain becomes blocked. During freezing conditions this may be due to the forming of ice in the condensate drain external to the house.

- Release an ice blockage by the use of warm cloths on the pipe.

The boiler should then restart.

- Contact your Installation/ Servicing company or Glow-worm service if the fault persists.

10.4 Safety Discharge Valve

The safety discharge valve and discharge pipe is fitted to the boiler.

- If there is any discharge from the pipe, switch off the boiler electrical supply, then call your Installation/ Servicing company or Glow-worm service.

11 Appliance maintenance and servicing

11.1 Cleaning



Before cleaning turn the appliance off.

The appliance casing can be cleaned using a mild liquid detergent with a damp cloth, then a dry cloth to polish.



Do not use any form of abrasive or solvent cleaner as you may damage the paintwork.

11.2 Regular servicing

Regular servicing of the appliance is important to the prolonged, safe and efficient use of your appliance.



Incorrect or inadequate servicing can severely affect the safety of the appliance and can lead to injury.

We recommend that your appliance is serviced every year.

- Only use a competent person.

The service engineer should complete the relevant Service Record on the Benchmark Checklist after each service. The Benchmark Checklist may be required in the event of any warranty work and as supporting documentation relating to home improvements in the optional documents section of the Home Information Pack.

To obtain service, please call your installer or Glow-worm's own service organisation.

11.3 Spare Parts

In order to guarantee the safe and prolonged life of the product, insist that only the manufacturer's genuine spare parts are used.

- Do not use reconditioned or copy parts that have not been clearly authorised by Glow-worm.
- If replacement parts are required contact Glow-worm's own service organisation for advice using the telephone number below.

Tel: 01773 828100

or for approved stockist, visit www.glow-worm.co.uk.

- Please quote the name and model of the boiler.

The name and model badge is on the front case.

- If in doubt seek advice from the local gas company or Glow-worm's own service organisation using the telephone number below.

Tel: 01773 828100

11.4 Sealed Water Systems

The draining, refilling and pressurising **MUST** be carried out by a **competent person** approved at the time by the Health and Safety Executive.

- Contact Glow-worm's own service organisation using the telephone number below.

Tel: 01773 828100

12 Tips for saving energy

Your installer will be able to give energy saving advice about your system and its controls.

For energy saving advice you can contact the Energy Savings Trust for advice or visit www.energysavingtrust.org.uk who offer simple effective advice about saving energy.

Regular servicing of your boiler will help maintain its efficiency - servicing once a year is recommended.

Turn your thermostat down. Reducing your room temperature by 1°C could cut your heating bills by up to 10 percent. Set your heating and hot water at the time controller to come on only when required rather than all the time.

13 Contact your after-sales organisation

Customer service call

Tel: 01773 828100

Technical helpline

Tel: 01773 828300

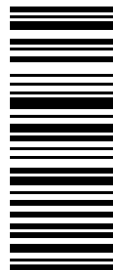

Subject to engineering changes

00200112186_PROTO_1001/11

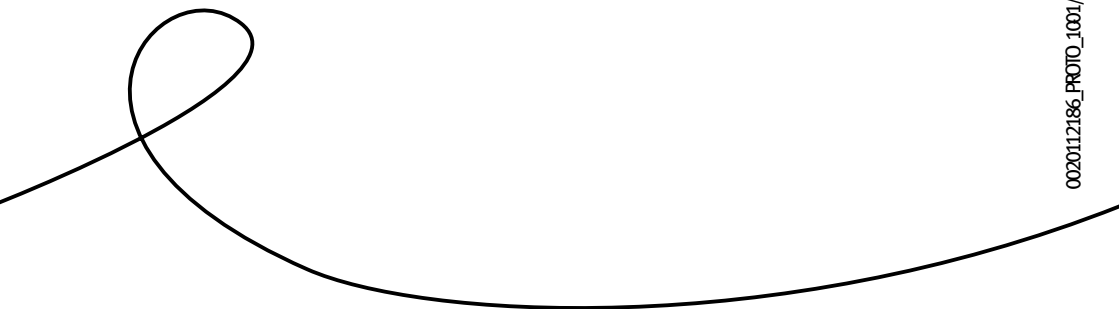

GLOW-WORM

Nottingham Road,
Belper, Derbyshire.
DE56 1JT

Because of our constant endeavour for
improvement, details may vary slightly
from those shown in these instructions.

Glow•worm

www.glow-worm.co.uk