

SAFETY & INSTRUCTION MANUAL

A Guide to the safe and proper use of Cherne Pneumatic Pipe Plugs

This manual covers Cherne
Pneumatic Plugs as follows:
Single Size Test-Ball® Plugs (8" & larger)
Multi-Size Test-Ball® Plugs (6" & larger)
Muni-Ball® Plugs
i-Series® Plugs
REMO® Plugs
BIG MOUTH® Plugs
AIR-LOC® Plugs
Factory Replaceable Sleeve
Large Pillow-Style Test Ball® Plugs

! WARNING
MUST READ THIS
MANUAL BEFORE
USING CHERNE
PNEUMATIC
PIPE PLUGS

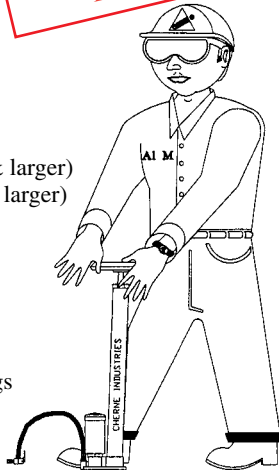

CHERNE INDUSTRIES INCORPORATED
5700 LINCOLN DRIVE
MINNEAPOLIS, MINNESOTA 55436-1695
PHONE: 1-800-843-7584
FAX: 1-800-843-7585

KEEP THIS MANUAL WITH PLUG FOR FUTURE REFERENCE

 **WARNING:** Plugs must be braced while in use.

Dedicated to the memory
of Allen D. Mathison
1946 – 1996

SAFETY INSTRUCTION MANUAL INDEX (REV 12)

I. GENERAL SAFETY AND USAGE INSTRUCTIONS (ENGLISH)	PAGE 5
II. ALLGEMEINE SICHERHEITS UND BEDIENUNGSANLEITUNGEN (GERMAN)	PAGE 6
III. SÉCURITÉ GÉNÉRALES ET INSTRUCTIONS D' UTILISATION (FRENCH)	PAGE 7
IV. ISTRUZIONI GENERALI SULLA SICUREZZA E L'USO (ITALIAN).....	PAGE 8
V. INSTRUCCIONES DE SEGURIDAD GENERAL Y USO (SPANISH)	PAGE 9
VI. 安全および使用上の一般説明 (JAPANESE)	PAGE 10
1. INTRODUCTION	PAGE 11
2. DETERMINE THE AMOUNT OF BACK PRESSURE THE PLUG MUST WITHSTAND FOR THE JOB OR APPLICATION	PAGE 12
3. DETERMINE THE USAGE TEMPERATURE AND THE MEDIA THE PLUG MUST WITHHOLD	PAGE 16
4. MEASURE THE PIPE AND SELECT THE PROPER PLUG AND RELATED EQUIPMENT	PAGE 17
5. CLEAN PLUG AND RELATED EQUIPMENT BEFORE EVERY USE AND INSPECT FOR DAMAGE.....	PAGE 20
6. SELECT AND USE PROPER SAFETY AND PROTECTIVE EQUIPMENT	PAGE 22
7. RECOMMENDED SAFETY PROCEDURES FOR ENTRANCE INTO MANHOLES AND OTHER CONFINED SPACES	PAGE 24
8. CLEAN PIPE BEFORE PLACING PLUG	PAGE 25
9. ATTACH INFLATION HOSE TO ENABLE PLUG INFLATION AND DEFLATION FROM OUTSIDE DANGER ZONE	PAGE 26

10. PROPER PLUG PLACEMENT IN PIPE	PAGE 28
11. PROVIDE A BACKUP SYSTEM FOR SAFETY	PAGE 32
12. PROPER PNEUMATIC PLUG INFLATION	PAGE 33
13. PROPER PNEUMATIC PLUG REMOVAL	PAGE 36
14. CLEAN AND INSPECT PLUG AFTER EVERY USE AND STORE PROPERLY	PAGE 38
15. SPECIAL CAUTION TO EMPLOYERS AND CONTRACTORS	PAGE 39
16. PRODUCT USAGE DATA.....	PAGE 40
17. SPECIAL USAGE INSTRUCTIONS FOR GRAVITY FLOW BYPASS APPLICATIONS	PAGE 52
18. LIMITED WARRANTY	PAGE 54

The Cherne products described in this manual may be covered by one or more of the following Patents and trademarks: US Patent Numbers 3,834,422 3,951,173 4,096,977 4,274,206 4,493,344 4,588,110 4,614,206 4,763,511 4,817,671 5,035,266 5,076,328 5,209,266 5,234,034 5,329,646 5,353,841 DES 300,350 DES 339,405 DES 350,704 DES 351,013 DES 358,871 DES 362,713 DES 369,652 DES 370,055 DES 370,715 (additional patents pending). Trademark Numbers 625,158 717,948 718,126 718,373 737,860 816,386 930,319 906,675 912,238 1,138,344 1,145,721 1,163,062 1,276,011 1,360,285 1,428,285 1,574,687 1,559,813 1,937,973 (additional trademarks pending). Additional foreign trademarks are not listed.

© Copyright 1991, 1992, 1998, 2000, 2007 All Rights Reserved, Cherne Industries Incorporated

I. GENERAL SAFETY & USAGE INSTRUCTIONS

1. DEATH, BODILY INJURY AND/OR PROPERTY DAMAGE MAY RESULT IF PLUG FAILS FOR ANY REASON.
2. READ AND UNDERSTAND THIS SAFETY INSTRUCTION MANUAL BEFORE USING PLUG.
3. MUST WEAR SAFETY GLASSES AND A HARD HAT.
4. DO NOT ENTER DANGER ZONE WHEN PLUG IS IN USE.
5. MEASURE PIPE DIAMETER BEFORE SELECTING PLUG.
6. INSPECT PLUG FOR DAMAGE BEFORE AND AFTER USE.
7. NEVER USE A PLUG IN A PIPE SIZE DIFFERENT FROM RECOMMENDED USAGE RANGE (REFER TO THIS SAFETY INSTRUCTION MANUAL).
8. ALWAYS ATTACH AN INFLATION EXTENSION HOSE SO PLUG CAN BE INFLATED AND DEFLATED FROM OUTSIDE THE DANGER ZONE.
9. NEVER REMOVE THE INFLATION HOSE UNTIL ALL BACK PRESSURE IS RELEASED AND THE PLUG IS DEFLATED.
10. MUST INFLATE PLUG TO THE PRESSURE SHOWN ON PLUG.
11. ALWAYS USE PROPERLY CALIBRATED PRESSURE GAUGES.
12. DO NOT EXCEED RECOMMENDED MAXIMUM ALLOWABLE BACK PRESSURE (REFER TO THIS SAFETY INSTRUCTION MANUAL).
13. ALWAYS RELEASE BACK PRESSURE FROM THE PIPE FIRST, BEFORE DEFLATING PLUG.

CALL 1-800-THE-PLUG OR 1-952-933-5501 IF ADDITIONAL CLARIFICATION IS REQUIRED.

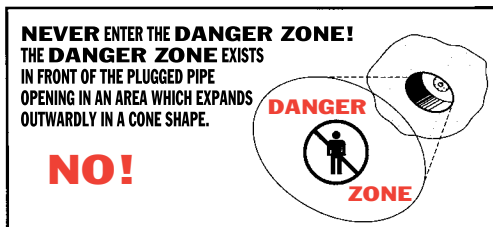

II. ALLGEMEINE SICHERHEITS UND BEDIENUNGSANLEITUNGEN

1. FALLS DER STÖPSEL AUS IRGEND EINEM GRUND VERSAGT, KANN DIES ZUM TOD, ZU VERLETZUNGEN UND/ODER ZU SACHSCHADEN FÜHREN.
2. LESEN SIE DIESES SICHERHEITSHANDBUCH DURCH, UND MACHEN SIE SICH MIT SEINEM INHALT VERTRAUT, BEVOR SIE DEN STÖPSEL BENUTZEN.
3. SICHERHEITSBRILLE UND SCHUTZHELM MÜSSEN GETRAGEN WERDEN.
4. DIE GEFAHRENZONE DARF NICHT BETRETEN WERDEN, WENN DER STÖPSEL BENUTZT WIRD.
5. MESSEN SIE DEN ROHRDURCHMESSER, BEVOR SIE DEN STÖPSEL WÄHLEN.
6. INSPIZIEREN SIE DEN STÖPSEL VOR UND NACH DEM GEBRAUCH AUF BESCHÄDIGUNGEN.
7. BENUTZEN SIE AUF KEINEN FALL EINEN STÖPSEL IN EINER ROHRGRÖSSE, DIE VOM EMPFOHLENE EINSATZBEREICH ABWEICHT (WIR VERWEISEN AUF DIESES SICHERHEITSHANDBUCH).
8. BEFESTIGEN SIE IMMER EINEN VERLÄNGERUNGSSCHLAUCH AM STÖPSEL, UM VON AUSSERHALB DER GEFAHRENZONE DEN DRUCK ERHÖHEN BZW. SENKEN ZU KÖNNEN.
9. ENTFERNEN SIE DEN VERLÄNGERUNGSSCHLAUCH AUF KEINEN FALL, WENN NICHT SÄMTLICHER RÜCKSTAU FREIGESETZT UND DER STÖPSEL ENTLEERT IST.
10. DER STÖPSEL MUSS AUF DEN AM STÖPSEL ANGEgebenEN WERT AUFGEBLASEN WERDEN.
11. BENUTZEN SIE IMMER ORDNUNGSGEMÄSS KALIBRIERTE MESSGERÄTE.
12. ÜBERSCHREITEN SIE NICHT DEN EMPFOHLENE MAXIMAL GESTATTETEN RÜCKSTAU (WIR VERWEISEN AUF DIESES SICHERHEITSHANDBUCH).
13. SETZEN SIE IMMER ZUERST DEN RÜCKSTAU AUS DEM ROHR FREI, BEVOR SIE DEN STÖPSEL ENTLEEREN.



III. SÉCURITÉ GÉNÉRALES ET INSTRUCTIONS D'UTILISATION

1. DES BLESSURES PHYSIQUES OU MORTELLES ET DOMMAGES À LA PROPRIÉTÉ PEUVENT ÊTRE CAUSÉS SI LE BOUCHON FAIT DÉFAUT POUR TOUTE RAISON.
2. LIRE ET COMPRENDRE CE MANUEL D'INSTRUCTION SUR LA SÉCURITÉ AVANT L'UTILISATION DU BOUCHON.
3. TOUJOURS PORTER DES LUNETTES DE SÉCURITÉ ET UN CASQUE PROTECTEUR.
4. NE PAS PÉNÉTRER DANS LA ZONE DE DANGER LORSQUE LE BOUCHON EST EN USAGE.
5. MESURER LE DIAMÈTRE DU TUYAU AVANT DE CHOISIR LE BOUCHON.
6. VÉRIFIER SI LE BOUCHON N'EST PAS ENDOMMAGÉ AVANT ET APRÈS L'UTILISATION
7. NE JAMAIS UTILISER UN BOUCHON POUR UN TUYAU DE GROSSEUR DIFFÉRENTE DU CHOIX RECOMMANDÉ (SE RÉFÉRER AU MANUEL D'INSTRUCTION SUR LA SÉCURITÉ).
8. TOUJOURS FIXER UN BOYAU DE RALLONGE DE GONFLEMENT DE FAÇON À CE QUE LE BOUCHON PUISSE ÊTRE GONFLÉ ET DÉGONFLÉ À L'EXTÉRIEUR DE LA ZONE DE DANGER.
9. NE JAMAIS RETIRER BOYAU DE GONFLEMENT TANT QUE TOUTE LA CONTRE-PRESSION NE SERA PAS DÉGAGÉE ET QUE LE BOUCHON NE SERA PAS DÉGONFLÉ.
10. GONFLER LE BOUCHON SELON LA PRESSION INDIQUÉE SUR CELUI-CI.
11. TOUJOURS UTILISER DE FAÇON APPROPRIÉE LES MANOMÈS CALBRÉS.
12. NE PAS DÉPASSER LA CONTRE-PRESSION MAXIMALE PERMISE ET RECOMMANDÉE (SE RÉFÉRER AU MANUEL D'INSTRUCTION SUR LA SÉCURITÉ).
13. TOUJOURS DÉGAGER LA CONTRE-PRESSION DU TUYAU EN PREMIER, AVANT DE DÉGONFLER LE BOUCHON.



IV. ISTRUZIONI GENERALI SULLA SICUREZZA E L'USO

1. DECESSO, LESIONI ALLE PERSONE E/O DANNI ALLE COSE POSSONO VERIFICARSI SE, PER UN MOTIVO QUALSIASI, IL TAPPO PNEUMATICO NON FUNZIONASSE CORRETTAMENTE.
2. LEGGERE E COMPRENDERE A FONDO IL PRESENTE MANUALE DI ISTRUZIONI SULLA SICUREZZA PRIMA DI USARE IL TAPPO PNEUMATICO.
3. È OBBLIGATORIO INDOSSARE OCCHIALI DI PROTEZIONE ED ELMETTO.
4. NON INTRODURSI NELLA ZONA DI PERICOLO MENTRE IL TAPPO PNEUMATICO È IN USO.
5. MISURARE IL DIAMETRO DELLA TUBATURA PRIMA DI SELEZIONARE IL TAPPO PNEUMATICO ADATTO.
6. ESAMINARE IL TAPPO PNEUMATICO PRIMA E DOPO L'USO PER RILEVARE GLI EVENTUALI DANNI DA ESSO SUBITI.
7. NON USARE MAI UN TAPPO PNEUMATICO SU UNA TUBATURA DI DIMENSIONI NON ELENATE TRA QUELLE CONSIGLIATE (CONSULTARE IL PRESENTE MANUALE DI ISTRUZIONI SULLA SICUREZZA).
8. COLLEGARE SEMPRE UN TUBO DI GONFIAMENTO DI PROLUNGA IN MODO CHE IL TAPPO PNEUMATICO POSSA ESSERE GONFIATO E SGONFIATO DALL'ESTERNO DELLA ZONA DI PERICOLO.
9. NON RIMUOVERE MAI IL TUBO DI GONFIAMENTO PRIMA DI AVER ELIMINATO TUTTA LA CONTROPRESSIONE E DI AVER SGONFIATO COMPLETAMENTE IL TAPPO PNEUMATICO.
10. È NECESSARIO GONFIARE IL TAPPO PNEUMATICO ALLA PRESSIONE MOSTRATA SUL TAPPO STESSO.
11. UTILIZZARE SEMPRE MANOMETRI CORRETTAMENTE CALIBRATI.
12. NON ECCEDERE LA CONTROPRESSIONE MASSIMA CONSENTITA (CONSULTARE IL PRESENTE MANUALE DI ISTRUZIONI SULLA SICUREZZA).
13. RILASCIARE SEMPRE LA CONTROPRESSIONE DALLA TUBATURA PER PRIMA, PRIMA DI SGONFIARE IL TAPPO PNEUMATICO.



V. INSTRUCCIONES DE SEGURIDAD GENERAL Y USO

1. SI EL TAPON FALLA POR CUALQUIER RAZON PUEDE PROVOCAR MUERTE, LESIONES CORPORALES Y/O DAÑOS A LA PROPIEDAD.
2. ANTES DE USAR EL TAPON LEA Y ENTIENDA ESTA MANUAL DE INSTRUCCIONES DE SEGURIDAD.
3. DEBE USAR GAFAS DE SEGURIDAD Y CASCO DURO.
4. NO ENTRE EN LA ZONA DE PELIGRO CUANDO ESTE EN USO EL TAPON.
5. MIDA EL DIAMETRO DE LA TUBERIA ANTES DE SELECCIONAR EL TAPON.
6. INSPECCIONE SI HAY DAÑOS EN EL TAPON ANTES Y DESPUES DE USARLO.
7. NUNCA USE UN TAPON EN UN TAMAÑO DE TUBERIA DIFERENTE DEL MARGEN DE USO RECOMENDADO (CONSULTE ESTE MANUAL DE INSTRUCCIONES DE SEGURIDAD).
8. SIEMPRE INSTALE UNA MANGUERA DE EXTENSION DE INFLACION DE MANERA QUE EL TAPON PUEDA INFLARSE Y DESINFLARSE DESDE FUERA DE LA ZONA DE PELIGRO.
9. NUNCA RETIRE LA MANGUERA DE INFLACION HASTA QUE SE LIBERE TODA LA PRESION ACUMULADA Y EL TAPON ESTE DESINFLADO.
10. DEBE INFLAR EL TAPON A LA PRESION ILUSTRADA EN EL TAPON.
11. SIEMPRE USE MEDIDORES DE PRESION CALIBRADOS EN FORMA CORRECTA.
12. NO SOBREPASE LA PRESION ACUMULADA PERMITIDA MAXIMA RECOMENDADA (CONSULTE ESTE MANUAL DE INSTRUCCIONES DE SEGURIDAD).
13. SIEMPRE LIBERE LA PRESION ACUMULADA DESDE LA TUBERIA PRIMERO, ANTES DE DESINFLAR EL TAPON.



VI.

安全および使用上の一般説明

1. 何等かの理由でプラグが正常に機能しない場合、死亡事故、怪我および/または器具の破損事故が生じる可能性があります。
2. この安全操作説明書を読んで理解してからプラグを使用するようにしてください。
3. 安全ゴーグルとヘルメットを必ず着用してください。
4. プラグの使用中は、危険帯域に入らないでください。
5. プラグを選択する前にパイプの直径を測定してください。
6. 使用前と後にプラグの損傷の有無をチェックしてください。
7. 指示されている使用範囲外のサイズのパイプには決してプラグを使用しないでください。
8. 常に膨張用延長ホースを取り付けて、危険帯域の外部からプラグの膨張収縮操作ができるようにしてください。
9. 全ての背圧が放出されプラグが収縮するまでは、膨張ホースを決して外さないでください。
10. プラグに記載されている圧力までプラグを膨張させる必要があります。
11. 常に正しく較正されている圧力計を使用してください。
12. 指示されている最大限の背圧を越えないでください（この安全操作説明書を参照）。
13. 必ず最初にパイプから背圧を放出し、次にプラグの空気を抜くようにしてください。

決して危険帯域に入らないでください！

危険帯域はプラグを挿入したパイプ口の前部で、円錐状に外側に広がった地域です。

入るな！

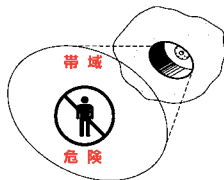

1. INTRODUCTION.

CAREFULLY READ, UNDERSTAND AND FOLLOW THE USAGE

INSTRUCTIONS OUTLINED IN THIS BOOKLET. The safety recommendations, principles and guidelines outlined in this manual apply to the use of all Cherne pneumatic pipe plugs. All Cherne products are designed, engineered and inspected with safety in mind. Cherne cannot control or predict the unlimited work place variables that can affect safety and usage conditions. Therefore safety must be your responsibility too! **THINK AND PRACTICE SAFETY WHENEVER YOU USE A PIPE PLUG!**

THANK YOU FOR PURCHASING AND USING CHERNE PNEUMATIC PLUGS AND ACCESSORIES.

The instructions and warnings in this manual are provided to assist you, our customer, to receive maximum benefit from the safe use of our products. This manual may be freely copied and distributed. Additional copies are available, at no charge, upon request. If you need additional copies or have questions call Cherne toll free at 1-800-843-7584 or fax toll free at 1-800-843-7585. Emergency assistance and emergency product shipment (surcharge applies to emergency after hours shipments) is also available through the toll free 1-800-843-7584 phone number 24 hours per day.

CHERNE WISHES TO EXPRESS THANKS TO THOSE WHO HAVE CONTRIBUTED TO THIS MANUAL.

If you have suggestions on how we can improve this manual or have additional data you think would be pertinent that should be added, please call Cherne toll free at 1-800-843-7584.

CHERNE PROVIDES TRAINING ASSISTANCE. If your organization (eg. Union School, Tech School, Sewage District, Trade Organization, etc.) provides training on a topic such as testing, product safety or a related topic, please contact us for help. Cherne will provide free training materials (eg. copies of testing standards, product catalogs, Safety Instruction Manuals, specification sheets, safety tags, etc.) to assist your presentation. Upon request, a company representative may assist in the presentation. Call Cherne toll free at 1-800-843-7584 to further discuss this assistance.



WARNING AN INHERENT DANGER EXISTS WITH ALL INFLATABLE PRODUCTS, ANY PRESSURIZED PIPELINE OR OTHER PRESSURE CONTAINMENT SYSTEMS! Every pneumatic plug, like tires, will eventually wear out and fail from continued use. Abuse and misuse will greatly accelerate this failure. Always protect against the eventuality of plug failure to prevent injury and property damage. If any conditions exist with equipment that may jeopardize the safety of yourself or others or if you are unsure about proper use, **DO NOT USE THE EQUIPMENT.** If you have any questions or think any unusual conditions exist that are not described in this booklet, consult your supervisor or safety director before proceeding. **FAILURE TO COMPLY WITH THESE SAFETY INSTRUCTIONS OR THOSE OF OSHA AND YOUR FEDERAL, STATE OR LOCAL GOVERNMENTS, MAY RESULT IN DEATH, SERIOUS BODILY INJURY AND/OR PROPERTY DAMAGE!**

2. DETERMINE THE AMOUNT OF BACK PRESSURE THE PLUG MUST WITHSTAND FOR THE JOB OR APPLICATION.

DETERMINE THE MAXIMUM BACK PRESSURE (the differential fluid pressure, either air or liquid, restrained by the plug) the plug must withstand before selecting a plug.

WATER BACK PRESSURE (hydrostatic back pressure) is measured in either feet-of-head (fluid height above centerline of the plug) or PSIG (Pounds Per Square Inch Gauge). **AIR BACK PRESSURE** (pneumatic back pressure) is measured in PSIG (Pounds Per Square Inch Gauge). See Conversion Table on page 15.

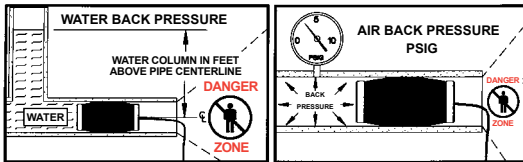

MAXIMUM ALLOWABLE BACK PRESSURE for each Cherne pneumatic pipeline plug is clearly outlined in the data section of this manual, Cherne catalogs and product specification sheets. Maximum back pressure ratings listed are for plugs installed in clean, dry pipe of nominal size. Usage of plugs in pipeline that varies from these conditions may reduce maximum allowable back pressure.

MAXIMUM BACK PRESSURE RATING - AIR VERSUS WATER. Pipeline plugs will normally hold (withstand) nearly equal back pressure for water pressure (hydrostatic pressure) or air pressure (pneumatic pressure). However, extra caution must be given when using a plug in an air pressure application. Air pressure is more likely to cause a pipeline plug to dislodge at high velocity.

EQUAL BACK PRESSURE MAY BE RESTRAINED FROM EITHER THE FRONT OR THE BACK OF THE PLUG. VACUUM IS NEGATIVE PRESSURE.

A plug's maximum allowable back pressure rating is independent of the direction the back pressure is applied. This also includes pressure caused by a vacuum which is equivalent to a negative pressure in the direction of the vacuum. Each 1" Hg (Mercury) of vacuum is approximately -0.5 PSIG of pressure. If pressure exists on one side of the plug and vacuum on the other side, the forces must be added to calculate total back pressure. A vacuum may be created by pumping water from either side of the plug and not venting the evacuated area.

NEVER ENTER THE DANGER ZONE. The approximate Danger Zone exists in front of the plugged pipe opening in an area which expands outwardly in a cone shape. The Danger Zone includes the entire area where a pipeline plug, any portions (fragments) thereof and/or any media (back pressure) restrained by the pipeline plug may be ejected from the pipeline should the plug rupture or dislodge for any reason. Although the Danger Zone described applies to normal usage conditions, the foreseeable Danger Zone increases as inflation pressure is increased, as back pressure builds and by possible ricochet effects from pipes, walls or other objects in the Danger Zone. The area of foreseeable Danger Zone may be reduced by the use of a backup system (refer to Section 11 of this manual).

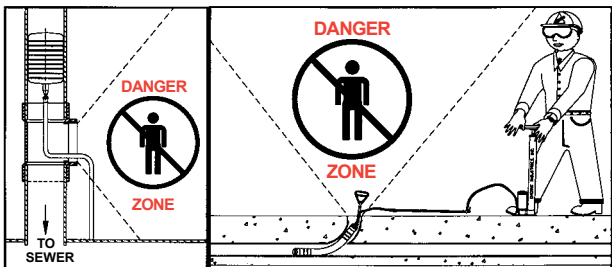

! DANGER NEVER ENTER INTO THE FORESEEABLE DANGER ZONE WHEN A PNEUMATIC PLUG IS INFLATED EVEN IF NO BACK PRESSURE EXISTS IN THE PIPE! IF YOU OR ANYONE ELSE IS IN THE DANGER ZONE AND THE PLUG FAILS OR DISLODGES FOR ANY REASON, FAILURE TO HEED THIS WARNING MAY RESULT IN DEATH, SERIOUS BODILY INJURY AND/OR PROPERTY DAMAGE!

MONITOR BACK PRESSURE DURING PLUG USE. Monitor water back pressure by attaching a calibrated pressure gauge or a vertical sight tube to the bypass of a Muni-Ball® plug. A gauge must be located at pipe centerline to accurately measure water pressure. Other applications may allow direct measurement of the water column height restrained by the plug. Air back pressure can be monitored by attachment of a calibrated pressure gauge to the plug bypass port using an extension hose. This allows accurate back pressure readings from a remote location outside of the Danger Zone.

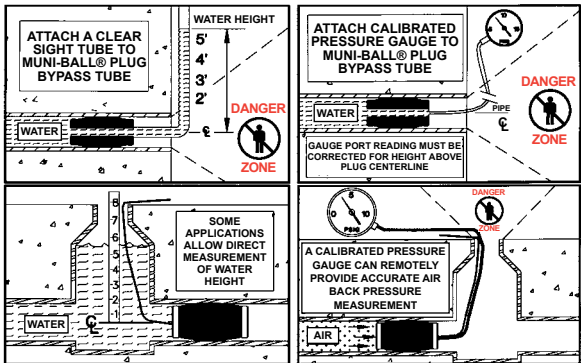

WATER WILL ACCUMULATE BEHIND ANY PLUG BLOCKING A FLOWING LINE. The flow will gradually increase the water column height behind the plug. Prior to installing a plug, the user must determine the maximum water height that may accumulate during plug use.

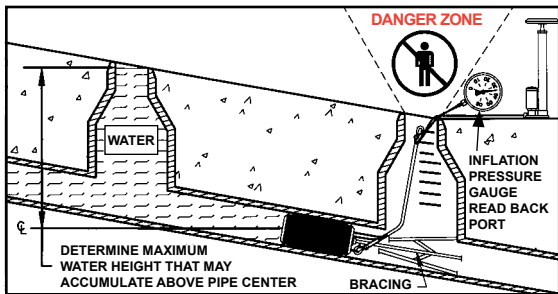

HOW TO CALCULATE PIPELINE FORCES AND PRESSURES.

A. MEASURE THE INSIDE DIAMETER OF THE PIPELINE IN INCHES.

B. DETERMINE THE MAXIMUM BACK PRESSURE. Air pressure is measured in PSIG (Pounds Per Square Inch Gauge). Water pressure is calculated by determining the height of water column in feet above the center line of the pipe. Water height is multiplied by (0.43) to yield water pressure in PSIG. A FEET-OF-WATER-HEAD TO PSIG conversion table is also provided (see Table 1, next page).

C. CALCULATE THE PIPE AREA IN SQUARE INCHES. Area of a circle (square inches) = [Diameter (in inches) x Diameter (in inches) x 3.1416 (pi)] / 4.

D. CALCULATE THE FORCE THE PLUG MUST WITHSTAND. FORCE = PIPE AREA (in square inches) x PRESSURE (PSIG).

EXAMPLE: A plug must hold a (10) foot column of water above the centerline of a 60" diameter pipe.

PIPE AREA = [60" (dia.) x 60" (dia.) x 3.1416 (pi)] / 4 = 2,827 square inches.

PRESSURE = 10 Feet of Water x 0.43 PSIG/Foot = 4.3 PSIG

PIPE AREA (2,827 square inches) x PRESSURE (4.3 PSIG) = FORCE = 12,157 pounds.

CONVERSION TABLE
FEET-OF-WATER-HEAD TO PSIG
(Pounds Per Square Inch Gauge)

FT.-OF-HEAD	PSIG	FT.-OF-HEAD	PSIG	FT.-OF-HEAD	PSIG	FT.-OF-HEAD	PSIG
1	= 0.43	16	= 6.93	31	= 13.42	46	= 19.92
2	= 0.87	17	= 7.36	32	= 13.86	47	= 20.35
3	= 1.30	18	= 7.79	33	= 14.29	48	= 20.78
4	= 1.73	19	= 8.23	34	= 14.72	49	= 21.22
5	= 2.16	20	= 8.66	35	= 15.15	50	= 21.65
6	= 2.60	21	= 9.09	36	= 15.59	51	= 22.08
7	= 3.03	22	= 9.53	37	= 16.02	52	= 22.52
8	= 3.46	23	= 9.96	38	= 16.45	53	= 22.95
9	= 3.90	24	= 10.39	39	= 16.89	54	= 23.38
10	= 4.33	25	= 10.82	40	= 17.32	55	= 23.82
11	= 4.77	26	= 11.26	41	= 17.75	56	= 24.25
12	= 5.20	27	= 11.69	42	= 18.19	57	= 24.68
13	= 5.63	28	= 12.12	43	= 18.62	58	= 25.11
14	= 6.06	29	= 12.56	44	= 19.05	59	= 25.55
15	= 6.49	30	= 12.99	45	= 19.49	60	= 25.98

TABLE 1

 **WARNING** NEVER EXCEED THE PLUG'S BACK PRESSURE RATING! Maximum recommended back pressure ratings listed are for plugs installed in clean, dry pipe. Other pipe conditions, such as a pipe with debris or foreign substances on its surface, may significantly reduce back pressure holding capabilities. Harmful foreign substances may include grease, mold, algae, sand and/or any other material that prevents solid contact between the plug and the pipe wall. Pipe made from material having a low coefficient of friction, such as polyethylene, or new pipe having traces of release agent used as part of the manufacturing process may also reduce the back pressure holding capabilities. Corrugated piping will also reduce back pressure holding capabilities (by 50%—see page 18). IF SUCH CONDITIONS EXIST, IMMEDIATELY NOTIFY YOUR SUPERVISOR OR SAFETY DIRECTOR AND TAKE APPROPRIATE CORRECTIVE ACTION SUCH AS CLEANING BEFORE PROCEEDING! FAILURE TO HEED THIS WARNING MAY CAUSE PLUG DISLODGE­MENT WHICH MAY RESULT IN DEATH, SERIOUS BODILY INJURY AND/OR PROPERTY DAMAGE!

 **WARNING** TREMENDOUS FORCES MAY BE RESTRAINED INSIDE OF AND BY PIPELINE PLUGS WHEN THE PLUGS ARE INFLATED AND USED! Total force exerted on a pipeline plug is directly proportional to both the pressure and the pipeline area (refer to formula and example, page 14). ANY BARRIER OR BLOCKING DEVICE USED TO RESTRAIN THE PLUG IN A PIPELINE MUST BE PROPERLY DESIGNED AND CONSTRUCTED TO SAFELY WITHSTAND THE HIGH FORCES INVOLVED! FAILURE TO USE PROPER BRACING MAY RESULT IN DEATH, SERIOUS BODILY INJURY AND/OR PROPERTY DAMAGE (SEE PAGE 32)!

3. DETERMINE THE USAGE TEMPERATURE AND THE MEDIA THE PLUG MUST WITHHOLD.

TEMPERATURE RATING. Most standard Cherne natural rubber pneumatic plugs are designed for use at temperatures from 0 to +125 DEGREES F. (-18 to +52 DEGREES C.). Using a plug at a temperature below this minimum may cause the plug to stiffen, resulting in incomplete pipe contact, and the plug may dislodge when back pressure is applied. Usage at temperatures above this maximum may damage the plug body and the plug may rupture during inflation and/or use. If the application requires temperatures outside of these limits, call Cherne toll free at 1-800-843-7584 for recommendations.

USE OF PLUGS WITH CHEMICALS. If a plug is to be used in chemical environments, call Cherne toll free at 1-800-843-7584 for recommendations.

 **WARNING** MOST STANDARD CHERNE PNEUMATIC PLUGS ARE DESIGNED TO HOLD AIR OR WATER BACK PRESSURE ONLY AND MUST ONLY BE USED WITHIN THE DESIGNATED TEMPERATURE RANGE! Use with other media or at temperatures outside of designated range may cause the plug to fail. PLUG FAILURE MAY RESULT IN DEATH, SERIOUS BODILY INJURY AND/OR PROPERTY DAMAGE!

4. MEASURE THE PIPE AND SELECT THE PROPER PLUG AND RELATED EQUIPMENT.

EVERY PIPELINE PLUG HAS A MINIMUM AND MAXIMUM SEALING SIZE RANGE AND A MAXIMUM ALLOWABLE BACK PRESSURE RATING.

The allowable sealing size usage range and maximum allowable back pressure are outlined in the data section of this manual, Cherne catalogs and specification sheets. Nominal plug size is clearly marked on the product. However, certain types and classes of pipe may have actual inside diameters that vary considerably from nominal diameters and may, therefore, be larger or smaller than the plug's sealing size usage range.

MEASURE THE INSIDE DIAMETER OF THE PIPE. VERIFY THE DIAMETER IS WITHIN THE PLUG'S RECOMMENDED SEALING SIZE USAGE RANGE. NEVER EXCEED MAXIMUM ALLOWABLE BACK PRESSURE. VERIFY THAT THE PROJECTED BACK PRESSURE IS WITHIN THE PLUG'S MAXIMUM ALLOWABLE BACK PRESSURE RATING.

PNEUMATIC PLUGS ARE ONLY RECOMMENDED FOR TEMPORARY SEALING.

Pneumatic pipeline plugs are to be used only for the few hours that are necessary to perform a task! If a pneumatic plug must be used for extended periods, the inflation pressure must be CHECKED AND ADJUSTED (IF NECESSARY) EVERY FOUR HOURS. Over time, a small volume of air will leak through the elastomeric (rubber) body of every pneumatic plug. The lost air must be replaced or under-inflation may result allowing the plug and any media restrained to dislodge from the pipe. A regulated pressure source may be permanently attached to the plug's inflation inlet port as an alternative to periodically checking and adjusting the inflation pressure. Consult with a registered professional engineer for the construction and maintenance of such a pressure regulated inflation source (refer to description of panel and warnings in Section 12 of this manual if you are constructing a regulated pressure source). For long term or permanent usage, a Cherne mechanical plug is recommended. Call Cherne toll free at 1-800-843-7584 for recommendations.

PNEUMATIC PLUGS VERSUS MECHANICAL PLUGS. Pneumatic plugs have many advantages over mechanical plugs. They normally have a much wider sealing range than mechanical plugs. Some pneumatic plugs may even be used in multiple sizes of pipes. Pneumatic plugs easily seal minor imperfections in pipe and can seal non-circular pipe shapes. Pneumatic plugs normally have a long contact area with the pipe which minimizes leakage in rough or porous pipe. They also can be inflated and deflated from a remote location out of the Danger Zone and can be positioned in many areas that are not accessible to mechanical plug use. Mechanical plugs have the advantage of not relying on inflation pressure to provide proper sealing and are a better choice for long term or permanent usage. When the plugging application requires a minimum sealing length, a narrow mechanical plug may be the only viable option, as proper installation of a long pneumatic plug may not be possible. Mechanical plugs generally have a much shorter sealing length requirement.

CORRUGATED PIPE. Pneumatic plugs may be used in corrugated pipe. However, the plug will not fully fill the pipe corrugations, resulting in reduced contact area. Maximum allowable back pressure, therefore, must be reduced by 50% (eg. a plug normally rated for 30 feet of back pressure must be derated to 15 feet). Minor media leakage may still result along the longitudinal pipe construction seams. When a plug is used in spiral type corrugated pipe, a section of corrugations must be filled with a material such as cement grout to prevent major leakage around the spirals.

PLUGS MAY NOT TOTALLY SEAL SOME TYPES OF PIPE. When pipes have rough or very uneven surfaces, such as brick lined pipe, the plug may allow minor leakage of the restrained media. Some concrete pipe is very porous and media may leak past the plug through the pipe itself. The surface of the pipe may need to be coated with sealant to prevent such leakage. Other concrete pipe has a cast in place plastic liner, and leakage may occur under the liner. The edges of the plastic liner may require caulking to provide a leak free seal. Other pipe with sharp (90°) corners, longitudinal seams or defects may provide a leakage path past the plug. **DO NOT** attempt to prevent the leakage described above by over-inflation of the plug. Over-inflation will not provide a better seal and the plug may rupture catastrophically and dislodge at high velocity. Such leakage may only be minimized or eliminated by mechanically blocking the leakage path with material such as caulk or cement grout.

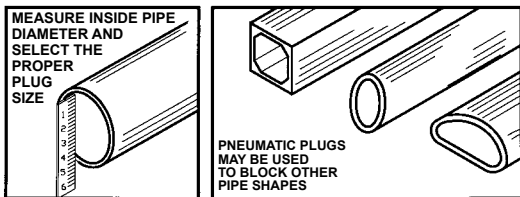



OTHER PIPE SHAPES. Pneumatic plugs may also be used to block pipes that have non-circular cross sections (eg. elliptical, arch or rectangular). Measure the pipe and call Cherne toll free at 1-800-843-7584 for recommendations for your application. A standard plug or fabrication of a custom sized product may be recommended. Cherne can quickly determine what plug will best meet your performance requirements.

DETERMINE THE TYPE OF PNEUMATIC PLUG REQUIRED. Cheme offers a wide variety of plug types including:

- a. Blocking type pneumatic plugs (Test-Ball® plugs).
- b. Plugs for sealing wyees (Long Test-Ball® plugs and MS2® Long Test-Ball® plugs).
- c. Plugs for sealing test tees (Clean-Seal® plugs).
- d. Plugs with a bypass through the plug (Muni-Ball® plugs).
- e. Plugs with maximum bypass size for gravity flow bypass applications (Big-Mouth® Flow Through plugs).
- f. Plugs for remote placement (REMO® plugs).
- g. Plugs (large diameter) capable of fitting through small diameter openings (Urethane Test-Ball® and Muni-Ball® Plugs).
- h. Plugs for air testing sewer lines (AIR-LOC® plugs).

NOTE: Refer to Section 13 of this manual to determine what method will be used to remove back pressure before plug deflation. Then select the necessary plug(s) and related equipment. Many sizes of plugs are available in several product configurations optimized for specific applications. Consult your catalog, Cheme dealer or call Cheme toll free at 1-800-843-7584 for recommendations.

 **WARNING** NEVER ATTEMPT TO USE A PLUG PRODUCT IN A PIPE SMALLER OR LARGER THAN THE RECOMMENDED SEALING SIZE USAGE RANGE! Media leakage, product failure and/or plug dislodgement may result. PLUG FAILURE OR DISLODGE MENT MAY RESULT IN DEATH, SERIOUS BODILY INJURY AND/OR PROPERTY DAMAGE!

 **CAUTION** CHECK THE PRESSURE RATING OF THE PIPE TO BE SEALED. The pipe's internal pressure rating must exceed the inflation pressure for the pneumatic plug selected for use. A plug body may exert a force on the pipe wall nearly equal to the inflation pressure. Damage to the pipe, such as breakage, may occur if the pipe has a lower pressure rating than the plug's inflation pressure. Special caution should be used with brittle pipe such as clay or non-reinforced concrete if a plug is used before the pipe is properly backfilled.

5. CLEAN PLUG AND RELATED EQUIPMENT BEFORE EVERY USE AND INSPECT FOR DAMAGE.

CLEAN PLUG. Pneumatic plugs may be cleaned with a solution of mild detergent and water. After cleaning, flush the plug with clean water and allow it to air dry thoroughly before use.

INSPECT PLUG AND RELATED EQUIPMENT. Carefully inspect the pneumatic plug and all related equipment for indications of wear or deterioration prior to each use. The plug may be inflated slightly (1 PSIG - refer to warning on following page) to aid in the inspection process. After inflation, apply a solution of water and detergent to the equipment or submerge the product completely under water as an aid in locating leaks. Bubbles will form at the site of any air loss.

Look very carefully for evidence that any material of the plug assembly and related equipment has been damaged, weakened or is missing. The inspection should include but not be limited to looking for:

- a. Cuts.
- b. Abrasions.
- c. Punctures.
- d. Presence of a proper inflation source (refer to Section 12 of this manual).
- e. Bulges.
- f. Cracked castings.
- g. Softening of elastomer (rubber).
- h. Cracks in elastomer (rubber).
- i. Corrosion.
- j. Loose, corroded or damaged fittings.
- k. Leaks from or damage to inflator assembly.
- l. Leaks from or damage to inflation extension hoses.
- m. Dirt or debris lodged in the inflator valve which may cause a slow inflation leak.
- n. Protective inflator cap in place.
- o. An orange warning tag attached to the plug. Replacement tags are available at no charge, upon request. Call Cherne toll free at 1-800-843-7584 and ask for a Warning Tag.
- p. A copy of this Safety Instruction Manual to accompany plug for user reference. NOTE: Call Cherne toll free at 1-800-843-7584 to request the most current revision of the Safety Instruction Manual. Additional application information, instructions and warnings are periodically added as Cherne becomes aware of such information. Additional Manual copies are available from Cherne, at no charge, upon request.
- q. Loose or damaged banding clamps.
- r. Eye bolts, chain and ring or tether attachment in location.
- s. Inflator valve core in place, properly tightened and leak free in the inflation fitting.
- t. Presence of a properly calibrated inflation pressure gauge to accurately determine inflation pressure (refer to Section 12 of this manual).

IF ANY EVIDENCE OF DAMAGE, DETERIORATION, MISSING COMPONENTS, WARNING TAG/MANUAL LOSS, OR EXCESS WEAR IS OBSERVED, CONSULT YOUR LOCAL CHERNE DEALER OR REPRESENTATIVE AND MAKE ARRANGEMENTS TO RETURN THE PRODUCT FOR INSPECTION OR DESTROY

THE PRODUCT (cut, puncture or otherwise disable the discarded product to prevent any inadvertent use and subsequent failure) AND REPLACE IT WITH A NEW PLUG OR RELATED PLUG EQUIPMENT BEFORE PROCEEDING. IF YOU ENCOUNTER OR OBSERVE ANY UNUSUAL CONDITIONS THAT ARE NOT EXPLAINED HERE, REMOVE THE PLUG OR EQUIPMENT FROM SERVICE AND NOTIFY YOUR SUPERVISOR OR SAFETY DIRECTOR.

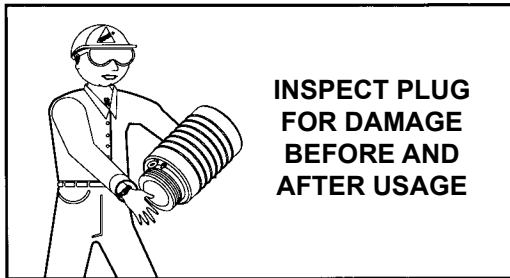

! WARNING NEVER ATTEMPT TO CLEAN A PNEUMATIC PLUG WITH SOLVENTS OR PETROLEUM PRODUCTS! This may cause severe damage to the plug. The damage may be below the plug surface and not be obvious during inspection. THE PLUG MAY FAIL UPON INFLATION OR USE RESULTING IN DEATH, SERIOUS BODILY INJURY AND/OR PROPERTY DAMAGE!

! WARNING DO NOT INFLATE PLUG IN EXCESS OF ONE (1) PSIG WHEN PLUG IS NOT IN A PIPE! Plugs are designed only to be fully inflated when properly positioned in a pipe. THE PLUG MAY FAIL RESULTING IN DEATH, SERIOUS BODILY INJURY AND/OR PROPERTY DAMAGE!

! WARNING FAILURE TO CAREFULLY INSPECT EQUIPMENT BEFORE USE MAY CAUSE PLUG RUPTURE OR DISLODGE MENT WHICH MAY RESULT IN DEATH, SERIOUS BODILY INJURY AND/OR PROPERTY DAMAGE!

6. SELECT AND USE PROPER SAFETY AND PROTECTIVE EQUIPMENT.

NOTE: When plug use requires entry into a manhole or other confined space, it is important to refer to Section 7 of this manual.

SECURE THE JOB SITE. Each job site must be evaluated to determine proper safety procedures and equipment. It is extremely important to allow only experienced personnel to function in this decision-making capacity. If necessary, place barriers such as traffic cones to reroute pedestrian and vehicle traffic and to prevent entry into work area. NEVER allow unauthorized or untrained individuals inside the work perimeter. NEVER leave a pneumatic plug unattended in a unsecured location. Pedestrians or curiosity seekers may inadvertently enter into the Danger Zone. Vandalism or tampering with a pneumatic plug and accessories may result in plug failure or dislodgement.

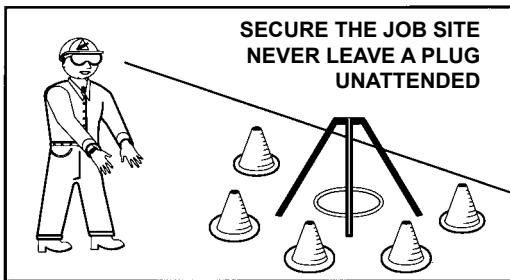

WEAR NECESSARY SAFETY EQUIPMENT. This includes safety glasses, a hard hat, ear protection, protective footwear and all other necessary protective clothing and equipment. Safety equipment and clothing required will depend upon the environment in which the product is used.

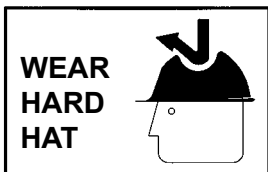

 **WARNING** FAILURE TO USE PROPER SAFETY EQUIPMENT OR TO SECURE THE JOB SITE MAY RESULT IN DEATH OR SERIOUS BODILY INJURY!

7. RECOMMENDED SAFETY PROCEDURES FOR ENTRY INTO MANHOLES AND OTHER CONFINED SPACES.

A. COMPLETE THE PROPER CONFINED SPACE ENTRY PERMIT.

B. EQUIP YOURSELF WITH THE NECESSARY SAFETY EQUIPMENT for entrance into the manhole or confined space. This may include, but not be limited to, the following recommended equipment:

- a. Safety Hat.
- b. Safety Glasses.
- c. Respirator With Self Contained Air Source.
- d. Safety Harness, Cables and Safety Winching System.
- e. Safety Shoes or Boots.
- f. Protective Gloves.
- g. Ear Protection.
- h. Hazardous Gas Detector and Oxygen Monitor.
- i. Confined Space Ventilation Equipment.
- j. Protective Clothing.
- k. Safety Ladders.
- l. Any Other Recommended or Required Equipment.

C. ENSURE THAT EQUIPMENT MEETS OR EXCEEDS MINIMUM REQUIREMENTS of all applicable regulatory guidelines. All equipment should be properly maintained, stored, calibrated (if necessary) and inspected prior to each use, in compliance with applicable regulations and equipment manufacturer's recommendations.

D. THOROUGHLY CHECK FOR HAZARDOUS GASSES AND PROPER OXYGEN LEVELS (oxygen 20% minimum) at all levels before entering a confined space. Continuously monitor these levels when workers are in a confined space.

E. VENTILATE CONFINED SPACE before entry and continuously ventilate when anyone is in the confined space.

F. USE PROPER RETRIEVAL EQUIPMENT AND CO-WORKER ASSISTANCE. All personnel must be properly trained in the safety requirements for access to confined spaces.

IF YOU ENCOUNTER OR OBSERVE ANY CONDITIONS THAT ARE NOT EXPLAINED HERE OR ARE NOT FULLY UNDERSTOOD BY YOU, NOTIFY YOUR SUPERVISOR OR SAFETY DIRECTOR BEFORE PROCEEDING.

! **WARNING** THESE RECOMMENDATIONS ARE TO BE USED AS A GENERAL GUIDELINE ONLY! Although Cherne recommends these guidelines, it does not warrant, represent or assume any responsibility that these recommendations will fulfill all applicable Federal, State or Local requirements. Cherne assumes no liability for either personal injury or consequential damages resulting from the reliance on these recommendations. IT IS THE PRODUCT USER'S RESPONSIBILITY TO READ AND COMPLY WITH ALL APPLICABLE REGULATIONS. Refer to Code Of Federal Regulations, "CFR" Part 1926 and all other pertinent Federal, State and Local regulations. FAILURE TO COMPLY WITH ALL REQUIREMENTS MAY RESULT IN DEATH, SERIOUS BODILY INJURY AND/OR SUBSTANTIAL FINANCIAL PENALTIES!

8. CLEAN PIPE BEFORE PLACING PNEUMATIC PLUG.

PROPERLY CLEAN THE PIPELINE BEFORE INSTALLING A PNEUMATIC PLUG. Clean any debris or foreign substances which may reduce back pressure holding capability from the pipe before the plug is installed. Such foreign substances may include grease, mold, algae, sediment, seashells, coral, sand and/or any other material that prevents solid contact between the plug and the pipe wall. Cleaning methods may include using a high pressure cleaner or by using a wire brush followed with a water flush. Remove any sharp objects that may puncture plug upon inflation. If any debris remains in the pipe, it may cause the plug to seal improperly or cause damage to the plug upon inflation.

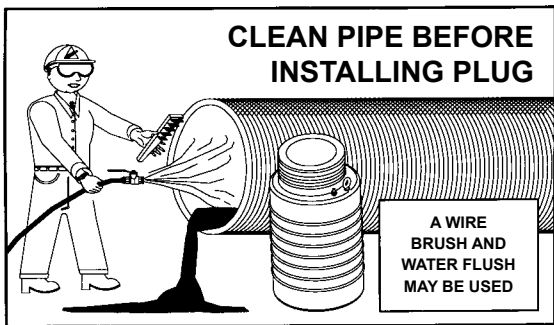

! **WARNING** FAILURE TO PROPERLY CLEAN PIPE MAY CAUSE PLUG DISLODGEMENT OR PLUG FAILURE WHICH MAY RESULT IN DEATH, SERIOUS BODILY INJURY AND/OR PROPERTY DAMAGE!

9. ATTACH INFLATION HOSE TO ENABLE PLUG INFLATION AND DEFLATION FROM OUTSIDE THE DANGER ZONE.

SELECT AN INFLATION HOSE AND OTHER ACCESSORIES. Cherne sells inflation extension hoses and lifting/inflation hoses (Poly-Lift Lines). Many of Cherne's larger pneumatic plugs are supplied with a second access port into the plug inflation area (contact Cherne toll free at 1-800-843-7584 for a list of plugs equipped with read back ports). This additional port allows attachment of a calibrated pressure gauge which provides continuous and accurate measurement of inflation pressure. The length and type of inflation hose needed will vary depending upon job site conditions but it must be of sufficient length to allow plug operation from outside the Danger Zone. When using a larger pneumatic plug, always secure a line to the plug's eyebolt(s) or other attachment point(s) before use. This will assist safe plug placement and plug removal. It also helps prevent inadvertent loss of the plug in a pipeline. A Poly-Lift Line with rope and anchor hooks is designed for this purpose. Ensure that any other inflation hose selected has sufficient strength to safely support the weight of the plug and accessories. Extension hoses and Poly-Lift Lines can be interchanged between various sizes and styles of pneumatic pipe plugs or linked together to allow operation from greater distances. Additional optional accessories allow plugs to be optimized for specific job requirements. Call Cherne toll free at 1-800-843-7584 for recommendations.

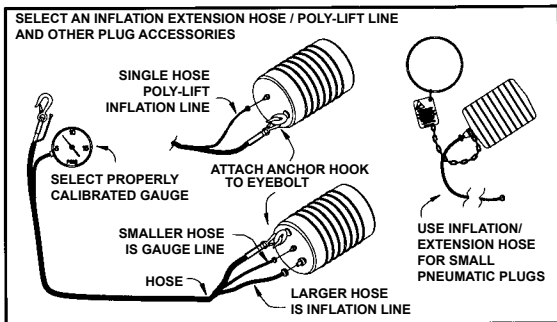

INSPECT INFLATOR ASSEMBLY OF PLUG AND EXTENSION HOSE (OR POLY-LIFT LINE) BEFORE USE AND REPLACE PROTECTIVE INFLATOR CAP AFTER USE. Ensure that there is no dirt or debris lodged in the inflator valve or other connections. Dirt or debris may prevent positive sealing of the inflator valve core. Carefully inspect inflation extension hoses to ensure that end fittings are properly crimped, that sealing washers are in place and that the hose is not worn or damaged. Ensure that the inflation valve core is in position and properly tightened. Such defects, left uncorrected, may cause a slow leak, resulting in under inflation and plug dislodgement. To ensure secure attachment to the plug, make sure the Poly Lift Line is not worn or abraded and that the end fittings are properly attached. If any damage is found to any component, repair or replace the equipment before use.

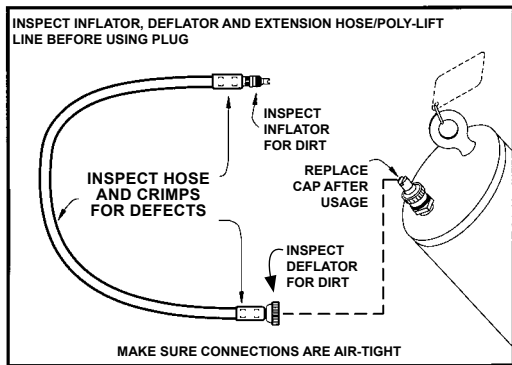

! WARNING DO NOT ATTEMPT TO USE AN EXTENSION HOSE AS A LIFTING OR CARRYING HANDLE OR AS A MEANS TO REMOVE THE PLUG FROM THE PIPELINE! This may weaken or damage the inflation line or the plug and result in a damaged or unsafe plug. Poly-Lift Lines, which are anchored to the plug, are designed for such use. THE DAMAGE MAY CAUSE PLUG FAILURE OR PLUG DISLODGE MENT WHICH MAY RESULT IN DEATH, SERIOUS BODILY INJURY AND/OR PROPERTY DAMAGE!

! WARNING ALWAYS ATTACH AN EXTENSION HOSE (or Poly-Lift Line) to enable plug inflation and deflation from outside the Danger Zone! NEVER REMOVE THE INFLATION HOSE (or Poly-Lift Line) until all back pressure is released and the plug is completely deflated! FAILURE TO HEED THIS WARNING MAY RESULT IN DEATH, SERIOUS BODILY INJURY AND/OR PROPERTY DAMAGE!

10. PROPER PLUG PLACEMENT IN PIPE.

POSITION THE PLUG INTO PIPE A MINIMUM DISTANCE OF ONE PIPE DIAMETER. Pneumatic plugs may elongate upon inflation, forcing the plug to protrude from pipeline and resulting in failure if not initially placed far enough into the pipe.

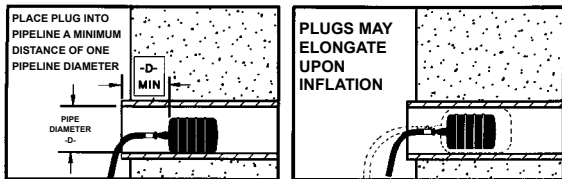

PLUGS USED FOR VACUUM TESTING OF MANHOLES. When plugs are used to seal the pipes entering a manhole for a vacuum test, the plugs must be placed well into the pipe beyond the manhole's sealing boot areas. Failure to properly position the plugs will prevent the sealing boot areas from being adequately tested, and leaks or bad seals may not be discovered. When a manhole is vacuum tested before being backfilled, the incoming pipes and plugs must be properly braced or blocked to prevent the pipes from being pulled into the manhole during the test.

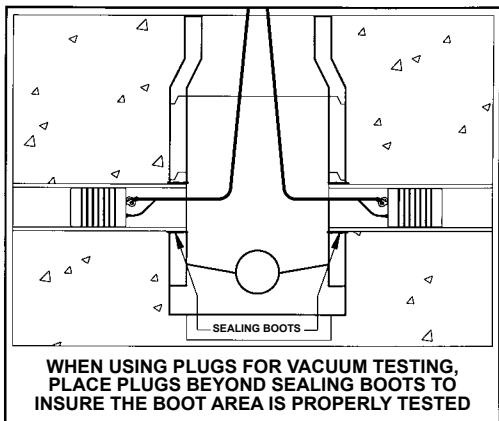

PLACING PLUG THROUGH RESTRICTED ACCESS. When plug placement requires installation through a restricted access, air may be forced from the plug to provide a minimum cross section. The inflation valve core or inflation fitting may be temporarily removed to aid deflation. The valve core or inflation fitting must be properly replaced and leak free (using pipe sealant or teflon tape), and the fitting's protective cap must be replaced. The plug body may be temporarily lashed with a rope to provide the minimum possible cross section for placement. The lashed plug is inserted into the pipe, the plug body is then untied, and the plug is properly positioned and then inflated normally. Use caution as the restricted access may cause the plug to be significantly more difficult to remove than to install. A vacuum pump may be used to extract air from larger pipeline plugs. Vacuum pump use may require fabrication of special inflation extension hose assemblies. Consult with a registered professional engineer for the design and construction of such assemblies.

BENDING FLEXIBLE PLUGS. If installation requires a flexible plug to be bent to reach proper position, temporary removal of the inflation valve core or inflation fitting will make the bending process easier. The valve core, inflation fitting and the fitting's protective cap must be properly replaced and be leak free (using pipe sealant or teflon tape).

NOTE: To prevent damage to, or collapse of, the bypass hose assembly of a flexible Muni-Ball[®] plug, **DO NOT** bend the plug body in excess of 90 degrees or attempt to exceed the maximum allowable bend radius of the bypass hose.

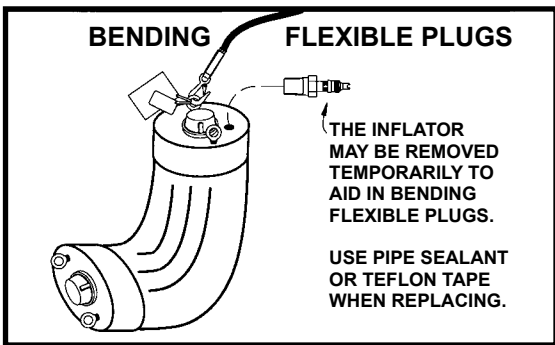

PLACEMENT OF PLUGS UNDER WATER. When installation requires a plug to be submerged, remove the inflation fitting and partially fill the plug with water to create neutral buoyancy. Properly replace the inflation fitting (using pipe sealant or teflon tape), correctly position the plug in the pipe and then inflate the plug normally with air through an inflation extension hose.

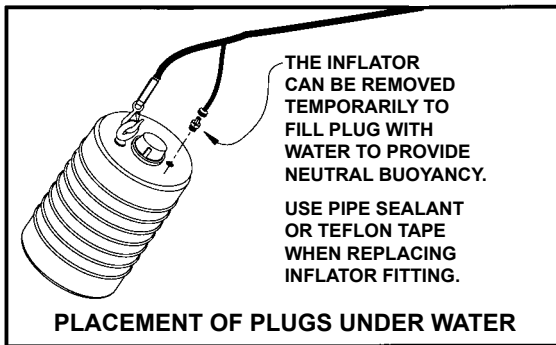

NEVER inflate a pneumatic plug over or near a sharp object or obstruction. Puncture of the plug body and failure may result upon plug inflation and use.

NEVER inflate a pneumatic plug over lateral openings. The plug may rupture upon inflation in the non-supported body area. Note: Cherne Long Test-Balls® and MS2® Long Test-Balls® are designed for use in wye pipeline sections where the plug body is not completely supported. Clean-Seal® plugs are designed for use in blocking test tees that have an unsupported area on each branch of the tee.

NEVER allow a pneumatic plug to protrude from the end of a pipeline during inflation or use. The plug may rupture upon inflation or dislodge when back pressure is applied.

NEVER inflate a pneumatic plug outside of a pipeline in excess of one (1) PSIG. The plug may rupture catastrophically.

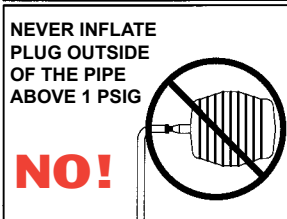

 **WARNING** FAILURE TO PROPERLY PLACE A PLUG BEFORE INFLATION MAY CAUSE PLUG FAILURE OR DISLODGE MENT WHICH MAY RESULT IN DEATH, SERIOUS BODILY INJURY AND/OR PROPERTY DAMAGE!

 **WARNING** NEVER ALLOW A PERSON IN THE ISOLATED TEST AREA SUCH AS A PIPE OR MANHOLE WHEN A PRESSURE OR A VACUUM TEST IS BEING PERFORMED. ALLOWING SOMEONE IN THE TEST AREA MAY RESULT IN DEATH OR SERIOUS BODILY INJURY!

11. PROVIDE A BACKUP SYSTEM FOR SAFETY.

NEVER RELY ON PIPELINE PLUGS AS THE ONLY MEANS TO PREVENT INJURY OR PROPERTY DAMAGE. NEVER ENTER THE DANGER ZONE DURING USE.

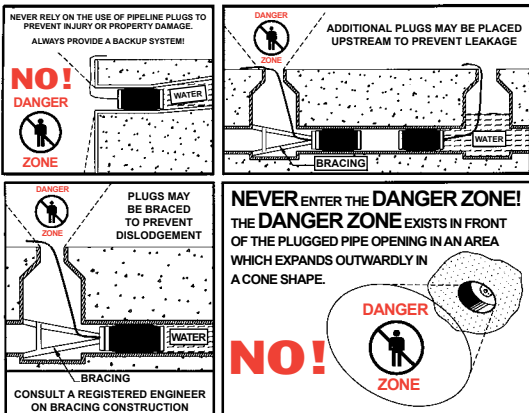

⚠ WARNING NEVER ATTEMPT TO USE THE EYE BOLTS, INFLATION HOSE, OR CARRYING HANDLE OF A PNEUMATIC PLUG AS A SAFETY TETHER OR AS A MEANS TO RESTRAIN THE PLUG IF IT IS DEFLATED WHILE HOLDING BACK PRESSURE! Safety bracing properly designed and constructed to withstand the tremendous forces involved is required. Eye bolts and carrying handles on most Cherne pneumatic plugs are designed only for carrying, lifting and lowering pneumatic plugs. They are NOT designed to withstand the large forces encountered when plugs are deflated when restraining back pressure. The carrying handles, eye bolts or their attachment to the pneumatic plug may fail, thereby damaging the plug itself and may result in unsafe conditions. THIS MAY CAUSE PLUG FAILURE WHICH MAY RESULT IN DEATH, SERIOUS BODILY INJURY AND/OR PROPERTY DAMAGE!

⚠ DANGER A FULLY OPERATIONAL BACKUP SYSTEM MUST BE USED IF THE PLUG IS USED IN ANY ENVIRONMENT WHERE PLUG LEAKAGE, FAILURE OR DISLODGE MENT FOR ANY REASON, COULD RESULT IN LIFE ENDANGERMENT, BODILY INJURY OR PROPERTY DAMAGE! The backup system must be designed to safely stop a dislodged plug and the pipeline media that will discharge upon plug failure. Consult a registered professional engineer for proper construction and maintenance of such a system. FAILURE TO PROVIDE A BACKUP SYSTEM MAY RESULT IN DEATH, SERIOUS BODILY INJURY AND/OR PROPERTY DAMAGE!

12. PROPER PNEUMATIC PLUG INFLATION.

PLACEMENT OF PLUGS BEFORE INFLATION. In most applications, plugs can simply be placed into proper position (refer to Section 10 of this manual) and then inflated to the proper inflation pressure. The inflation is performed from outside the Danger Zone using an inflation hose and a proper pressure source.

NOTE: Other applications may require a plug to be held in position until the plug body fully contacts the pipe (eg. attachment of fittings which cause the plug to tip during inflation). From a location outside the immediate Danger Zone the user may employ a device, such as a pole with attached hook, to position the plug. The plug is inflated using an inflation extension hose (or Poly-Lift Line) until it expands to make pipe wall contact. After initial pipe contact the user moves to a new position well outside the Danger Zone and continues inflation until the recommended pressure is reached.

USE PROPERLY CALIBRATED PRESSURE GAUGES to monitor inflation pressure and back pressure. Use of non-calibrated gauges may result in a condition of over-inflation or under-inflation (refer to following warnings).

NOTE: Rough handling, contamination or a sharp impact can quickly cause any pressure gauge to fall out of calibration. Other pressure gauges (eg. some inexpensive tire type gauges) are extremely inaccurate and should not be used. The user must select and maintain properly calibrated pressure gauges for use with pneumatic plugs.

INFLATE PLUG TO RECOMMENDED PRESSURE. Do not exceed this pressure. Proper inflation pressure is clearly marked on each product, outlined in this booklet and included in Cherne product catalogs and product specification sheets (refer to following warnings).

INFLATE PLUGS USING A PROPER PRESSURE SOURCE. A Cherne Test Pump equipped with a pressure gauge or a regulated air source with pressure gauge is required.

CHECK THE INFLATION PRESSURE AT LEAST EVERY FOUR (4) HOURS. A small volume of inflation air over time may/will leak through the elastomeric (rubber) body of every pneumatic plug. This lost air must be replaced or under-inflation may result allowing the plug and any media restrained to dislodge from the pipe. A regulated pressure source may be permanently attached to the plug's inflation inlet port as an alternative to periodically checking and adjusting the inflation pressure. Consult with a registered professional engineer for the construction and maintenance of such a pressure regulated inflation source.

INFLATION PRESSURE VERSUS TEMPERATURE. Any temperature increase or decrease will cause a corresponding change in inflation pressure. Monitor and adjust plug inflation pressure as necessary to compensate for temperature changes. NOTE: Temperatures in pipelines may vary widely from outside ambient temperatures. Monitor inflation pressure closely and adjust as necessary to maintain recommended pressure.

INFLATION OF PLUGS WITH MEDIA OTHER THAN AIR. Many Cherne pneumatic plugs may also be inflated with water or with inert gasses such as nitrogen (as long as all pressure sources are regulated). Consult with a registered professional engineer or call Cherne toll free at 1-800-843-7584 for recommendations (refer to following warnings).

 **WARNING ANY PNEUMATIC PLUG INFLATION SOURCE MUST BE EQUIPPED WITH A PRESSURE REGULATED OUTPUT MONITORED BY A PROPERLY CALIBRATED PRESSURE GAUGE!** Lack of such components may result in a condition of over-inflation or under-inflation. Consult with a registered professional engineer for the proper specification and design of such an inflation source. NEVER attempt to inflate a pneumatic plug using a non-regulated high pressure source (eg. Nitrogen tank, Scuba tank, non-regulated air compressor, etc). Catastrophic plug failure may result! USE OF AN IMPROPER INFLATION SOURCE MAY CAUSE PLUG FAILURE OR DISLODGE MENT WHICH MAY RESULT IN DEATH, SERIOUS BODILY INJURY AND/OR PROPERTY DAMAGE!



WARNING DO NOT OVER-INFLATE OR UNDER-INFLATE A PNEUMATIC PLUG! OVER-INFLATION of a pneumatic plug (exceeding the required inflation pressure) may cause the plug to rupture and dislodge at extreme velocity! UNDER-INFLATION of a pneumatic plug (inflation to pressure less than that required) may cause the plug and the media restrained to dislodge from the pipe! A plug that is over-inflated or under-inflated may not fail immediately. However such failure may occur at any time without warning! IMPROPER INFLATION MAY CAUSE PLUG FAILURE OR DISLODGE MENT WHICH MAY RESULT IN DEATH, SERIOUS BODILY INJURY AND/OR PROPERTY DAMAGE!

13. PROPER PNEUMATIC PLUG REMOVAL.

A. RELEASE ALL RESTRAINED MEDIA (back pressure) from a pneumatic plug before deflating the plug.

PLUGS PROPERLY BLOCKED OR SUPPORTED BY BRACING MAY BE DEFLATED TO RELEASE THE MEDIA RESTRAINED BY THE PLUG (BACK PRESSURE). Gradual plug deflation can control the rate of media discharge. Use extreme caution to ensure that such bracing is properly designed to withstand the full force of the plug and any restrained media. Ensure that any media released does not result in injury or property damage.

SOME CHERNE PRODUCTS ARE DESIGNED TO SAFELY RELEASE BACK PRESSURE WITHOUT THE USE OF BRACING. This includes MS2® Long Test-Ball® plugs and Clean-Seal® plugs which are simply deflated to release back pressure. Other plugs such as most sizes of pillow type Muni-Ball® and Test-Ball® plugs have tether attachment points of sufficient strength to allow attachment of an anchor cable that can withstand full rated back pressure. Call Cherne toll free at 1-800-843-7584 for specific recommendations.

A HOSE AND SHUT OFF VALVE MAY BE ATTACHED TO THE BY-PASS OF A MUNI-BALL® PLUG. The valve is opened from outside the Danger Zone to release back pressure. The back pressure may be released by gravity flow or the hose may be attached to the inlet of a water pump.

THE SUCTION HOSE OF A PUMP MAY BE INSERTED BEHIND A PLUG. Some applications allow direct access to the restrained media. Back pressure is relieved by activating the pump to remove the media.

THE BY-PASS OF A MUNI-BALL® PLUG MAY BE TEMPORARILY BLOCKED USING A SMALL PNEUMATIC PLUG. The small plug, connected to an inflation extension hose, is deflated from outside the Danger Zone to allow release of back pressure, air or water, through the Muni-Ball® bypass. **NOTE:** Damage to the small plug and extension hose may occur as the plug is ejected from the bypass area. Inspect the plug and hose carefully before attempting further use.

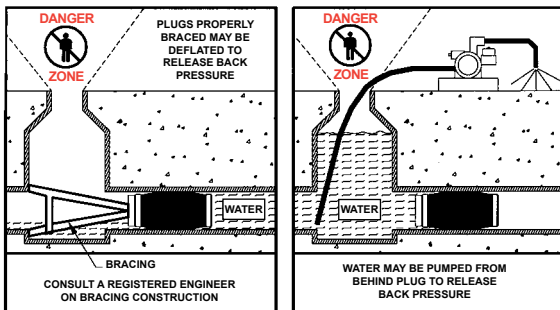

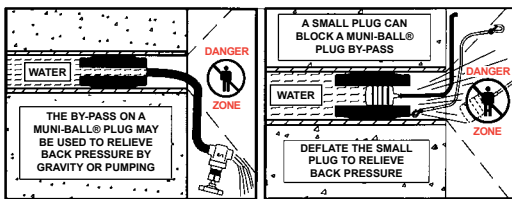

B. RELEASE THE AIR IN THE PNEUMATIC PLUG from outside the Danger Zone through the inflation extension hose until the plug is completely deflated. Full plug deflation minimizes possibility of plug damage during the removal process.

NOTE: A vacuum pump may be used to speed the deflation of larger plugs. The suction hose of a water pump may be needed to aid deflation of any plug inflated with water. These deflation aids may require fabrication of special inflation extension hose assemblies. Consult with a registered professional engineer for the design and construction of such assemblies.

C. REMOVE THE PLUG FROM THE PIPE. Fully deflate small plugs and simply pull on the attached chain and ring assembly to remove the plug. Fully deflate larger plugs and pull on the attached Poly-Lift Line or tether device to remove the plug. If unexpected resistance is encountered, stop pulling and carefully inspect the plug installation. Prevent damage to the plug and/or accessories by eliminating any obstructions before proceeding.

! WARNING DO NOT ATTEMPT TO USE AN EXTENSION HOSE AS A LIFTING OR CARRYING HANDLE OR AS A TETHER TO REMOVE THE PLUG FROM THE PIPELINE! This may weaken or damage the inflation line or the plug itself and result in a damaged or unsafe plug. THE DAMAGED PLUG MAY LATER FAIL WHICH MAY RESULT IN DEATH, SERIOUS BODILY INJURY AND/OR PROPERTY DAMAGE!

! WARNING DEFLATING A PNEUMATIC PLUG BEFORE ALL BACK PRESSURE IS RELEASED MAY CAUSE THE PLUG AND THE MEDIA RESTRAINED TO EJECT FROM THE PIPE AT HIGH VELOCITY! THIS MAY RESULT IN DEATH, SERIOUS BODILY INJURY AND/OR PROPERTY DAMAGE AND DAMAGE TO THE PLUG AND ACCESSORIES!

14. CLEAN AND INSPECT PLUG AFTER EVERY USE AND STORE PROPERLY.

A. CLEAN AND INSPECT PLUG as outlined in Section 5 of this manual.

B. STORE THE PLUG IN A CLEAN DRY PLACE, away from sunlight or other sources of ultra-violet light and away from sources of ozone, such as electrical equipment. Ozone and ultra-violet light may cause the elastomer (rubber) to weaken and fail prematurely.

C. STORE PLUGS BELOW 110 DEGREES F (43 degrees C). Exposure to excessive temperatures may cause damage to the elastomer of pneumatic plugs. NOTE: Storage of plugs in non-ventilated structures (such as metal buildings) may expose the plugs to excessive temperatures which may damage the plugs and possibly result in a plug failure.

D. ARMOR ALL® MAY BE USED AS A PRESERVATIVE on elastomeric (rubber) surfaces for extended storage. Apply only a light coating to the plug. Other water or silicone based preservatives may also be used (see warning below). (ARMOR ALL® is a Registered Trademark of Armor All Products Corp. Allso Vlejo, CA. USA 92656)

E. PLUGS MAY BE STORED SUSPENDED VERTICALLY OR PLACED HORIZONTALLY. When storing a plug, it is recommended that the plug be partially inflated to 1 PSIG only (see inflation warning below), which will prevent a permanent crease from forming in the plug body. A crease may cause a weakened area resulting in premature failure upon plug inflation or use.



WARNING DO NOT INFLATE PLUG IN EXCESS OF ONE (1) PSIG WHEN PLUG IS NOT IN A PIPE! Plugs are designed only to be fully inflated when properly positioned inside a pipe. THE PLUG MAY RUPTURE RESULTING IN DEATH, SERIOUS BODILY INJURY AND/OR PROPERTY DAMAGE!



WARNING EXCESSIVE COATING OF PRESERVATIVE ON ELASTOMER MAY RESULT IN A SLIPPERY PLUG SURFACE AND REDUCE THE BACK PRESSURE HOLDING CAPABILITIES! DO NOT COAT A PLUG IMMEDIATELY BEFORE USE AS THE COATING MAY REDUCE THE BACK PRESSURE HOLDING CAPABILITIES OF THE PLUG. If plug use is required and the plug has an excessive coating of preservative, the plug should be washed with solution of water and mild detergent, flushed with clean water and then allowed to air dry before use. USE OF SOME PRODUCTS SUCH AS PETROLEUM OR SOLVENT BASED COMPOUNDS MAY CAUSE SEVERE DAMAGE TO THE PLUG! The damage may be below the plug surface and not be obvious during inspection but failure may result upon plug inflation or use. PLUG FAILURE MAY RESULT IN DEATH, SERIOUS BODILY INJURY AND/OR PROPERTY DAMAGE!

15. SPECIAL CAUTION TO EMPLOYERS AND CONTRACTORS.

A. ENSURE THIS MANUAL IS KEPT FOR REFERENCE BY CURRENT/ FUTURE PLUG USERS. Employer must ensure that this manual is kept for reference by the user of Cherne products. For example, this booklet should be placed in the tool box of the plumber or user. This manual may be freely copied and distributed or additional copies may be obtained free upon request from Cherne by calling toll free at 1-800-843-7584.

B. INSTRUCT EMPLOYEES WITH THIS MANUAL ON THE PROPER USE OF PLUGS AND ALL RELATED EQUIPMENT. The employer or contractor has a duty to provide all necessary training on equipment usage. In addition, the employer or contractor must provide all necessary safety equipment and training, familiarize users with this manual and the purchased equipment, and provide copies of this SAFETY INSTRUCTION MANUAL for use on the job.

C. INSTRUCT EMPLOYEES AND WORKERS IN PROPER SAFETY PROCEDURES. The employer or contractor has a duty to properly instruct and ensure compliance with safety procedures and all applicable OSHA, Federal, State and Local rules.

D. INSTRUCT ALL EMPLOYEES AND WORKERS AS TO POSSIBLE HAZARDS. The employer or contractor has a duty to instruct as to possible hazards that may be encountered on the job, including the magnitude of the risk. The employer or contractor must inform employees of the proper methods for safe use of all the equipment including Cherne products and working in the job environment.

E. INSTRUCT ALL EMPLOYEES AND WORKERS REGARDING THE DANGERS OF ANY REASONABLY FORESEEABLE MISUSE OF THE PRODUCT. The employer or contractor has a duty to provide such information as set forth in this manual as well as anything else the employer or contractor is aware of. Such instruction is the contractor's or employer's duty. Should the employer or contractor be aware of such misuse, Cherne should be so informed.

F. INFORM ALL WORKERS OF THE COMPANY REPRESENTATIVE WHO IS RESPONSIBLE FOR SAFETY ON THE JOB. The employer or contractor must inform all workers who is responsible for safety on the job and for consultation regarding questions relating to Cherne product use and other safety considerations.

16. PRODUCT USAGE DATA.

Part #	Nominal Size Inches (mm)	Size Usage Range			Maximum Allowable Back Pressure		Required Inflation Pressure PSI (bar)
		Minimum Diameter Inches (mm)	Maximum Diameter Inches (mm)	Air PSI (bar)	Water Feet (Meters)		
Single-Size Test-Ball® Plugs							
041386	8" (200)	7" (178)	8.25" (210)	17 (1,2)	40 (12)	25 (1,7)	
041394	10" (250)	9" (229)	10.25" (260)	17 (1,2)	40 (12)	25 (1,7)	
041408	12" (300)	10.5" (267)	12.25" (311)	17 (1,2)	40 (12)	25 (1,7)	

Part #	Nominal Size Inches (mm)	Size Usage Range			Maximum Allowable Back Pressure		Required Inflation Pressure PSI (bar)
		Minimum Diameter Inches (mm)	Maximum Diameter Inches (mm)	Air PSI (bar)	Head Pressure Feet (M)		
Multi-Size Test Ball® Plugs: Sewer Applications (275 Series)							
275048	4" - 6" (100 - 150)	3.75" (92)	6.25" (159)	17 (1,2)	40 (12)	30 (2,1)	
275058	6" - 8" (150 - 200)	5.25" (140)	8.25" (210)	17 (1,2)	40 (12)	35 (2,4)	
275088	8" - 12" (200 - 300)	7.00" (178)	12.25" (311)	11 (0,75)	25 (8)	20 (1,4)	
275128	12" - 18" (300 - 450)	10.75" (273)	18.25" (464)	11 (0,75)	25 (8)	25 (1,7)	

 **WARNING: Plugs must be braced while in use.**

Part #	Nominal Size Inches (mm)	Size Usage Range			Maximum Allowable Back Pressure			Required Inflation Pressure PSI (bar)
		Minimum Diameter Inches (mm)	Maximum Diameter Inches (mm)	Air Pressure PSI (bar)	Head Pressure Feet (Meters)			
Single-Size Muni-Ball® Plugs*								
262008	1½" (40)	1.49" (38)	1.88" (48)	22 (1,5)	50 (15)	40 (2,8)		
262010	2" (50)	1.88" (48)	2.25" (57)	22 (1,5)	50 (15)	40 (2,8)		
262021	3" (75)	2.62" (67)	3.25" (83)	22 (1,5)	50 (15)	40 (2,8)		
262048	4" (100)	3.25" (83)	4.25" (108)	22 (1,5)	50 (15)	40 (2,8)		
262064	6" (150)	4.5" (114)	6.25" (159)	13 (0,9)	30 (9,1)	35 (2,4)		
262080	8" (200)	7" (178)	8.25" (210)	13 (0,9)	30 (9,1)	35 (2,4)		
262110	10" (250)	9" (229)	10.25" (260)	13 (0,9)	30 (9,1)	35 (2,4)		
262129	12" (300)	10.5" (267)	12.25" (311)	13 (0,9)	30 (9,1)	35 (2,4)		
262137	15" - 16" (375 - 400)	14" (356)	16.25" (413)	13 (0,9)	30 (9,1)	35 (2,4)		
262188	18" (450)	17.5" (445)	19.85" (504)	13 (0,9)	30 (9,1)	25 (1,7)		
262218	21" (525)	18.85" (479)	21.38" (543)	13 (0,9)	30 (9,1)	25 (1,7)		
262242	24" (600)	21.95" (558)	24.9" (632)	13 (0,9)	30 (9,1)	25 (1,7)		

 **WARNING: Plugs must be braced while in use.**

		Size Usage Range			Maximum Allowable Back Pressure			
Part #	Nominal Size Inches (mm)	Minimum Diameter Inches (mm)	Maximum Diameter Inches (mm)	Air Pressure PSI (bar)	Head Pressure Feet (Meters)	Required Inflation Pressure PSI (bar)		
Multi-Size Muni-Ball® Plugs*								
265048	4" - 6" (100 - 150)	3.75" (95)	6.25" (159)	17 (1,2)	40 (12)	35 (2,4)		
265068	6" - 8" (150 - 200)	5.5" (133)	8.33" (212)	17 (1,2)	40 (12)	35 (2,4)		
265078	8" - 10" (200 - 250)	7" (178)	10.25" (260)	17 (1,2)	40 (12)	30 (2,1)		
265098	8" - 12" (200 - 300)	7" (178)	12.25" (311)	17 (1,2)	40 (12)	25 (1,7)		
265128	12" - 18" (300 - 450)	10.75" (273)	18.8" (477)	13 (0,9)	30 (9,1)	25 (1,7)		

		Size Usage Range			Maximum Allowable Back Pressure			
Part #	Nominal Size Inches (mm)	Minimum Diameter Inches (mm)	Maximum Diameter Inches (mm)	Air Pressure PSI (bar)	Head Pressure Feet (Meters)	Required Inflation Pressure PSI (bar)		
Remo® Remote Placement Plugs								
275428	6" - 10" (150 - 250)	5.5" (140)	10.25" (260)	13 (0,9)	30 (9,1)	30 (2,1)		
275438	8" - 12" (200 - 300)	7" (178)	12.25" (311)	13 (0,9)	30 (9,1)	30 (2,1)		
275448	12" - 18" (300 - 450)	10.5" (273)	18.25" (464)	13 (0,9)	30 (9,1)	30 (2,1)		

 **WARNING: Plugs must be braced while in use.**

Part #	Nominal Size Inches (mm)	Size Usage Range			Maximum Allowable Back Pressure			Required Inflation Pressure PSI (bar)
		Minimum Diameter Inches (mm)	Maximum Diameter Inches (mm)	Air Pressure PSI (bar)	Head Pressure Feet (Meters)			
Large Multi-Size Test-Ball® Plugs with New Rupture Disc								
400308	15" - 30" (375 - 750)	14.5" (368)	30.5" (775)	See chart below*			25 (1,7)	
	at 15" (375)			17 (1,2)	40 (12)			
	at 18" (450)			13 (0,9)	30 (9)			
	at 21" (525)			13 (0,9)	30 (9)			
	at 24" (600)			11 (0,76)	25 (7,6)			
	at 30" (750)			11 (0,76)	25 (7,6)			
400428	24" - 42" (600 - 1050)	22.5" (570)	42.5" (1080)	See chart below*			25 (1,7)	
	at 24" (600)			15 (1,0)	35 (11)			
	at 30" (750)			13 (0,9)	30 (9)			
	at 30" DI (750)			13 (0,9)	30 (9)			
	at 36" (900)			11 (0,76)	25 (7,6)			
	at 42" (1050)			9 (0,62)	20 (6,1)			
400608	40" - 60" (1000 - 1525)	38" (965)	60.5" (1537)	See chart below*			25 (1,7)	
	at 40" - 42" (1000 - 1050)			15 (1,0)	35 (11)			
	at 42" (1050)			15 (1,0)	35 (11)			
	at 48" (1225)			13 (0,9)	30 (9)			
	at 54" (1375)			11 (0,76)	25 (7,6)			
	at 60" (1525)			8.7 (0,6)	20 (6,1)			
	at 60" DI (1525)			8.7 (0,6)	20 (6,1)			



WARNING: Plugs must be braced while in use.

Part #	Size Usage Range		Maximum Allowable Back Pressure			Required Inflation Pressure PSI (bar)
	Nominal Size Inches (mm)	Minimum Diameter Inches (mm)	Maximum Diameter Inches (mm)	Air Pressure PSI (bar)	Head Pressure Feet (Meters)	
Large Multi-Size Muni-Ball® Plugs with New Rupture Disc						
402308	15" - 30" (375 - 750)	14.5" (368)	30.5" (775)	See chart below*		25 (1,7)
	at 15" (375)			17 (1,2)	40 (12)	
	at 18" (450)			13 (0,9)	30 (9)	
	at 21" (525)			13 (0,9)	30 (9)	
	at 24" (600)			11 (0,76)	25 (7,6)	
404308	15" - 30" (375 - 750)	14.5" (368)	30.5" (775)	See chart below*		25 (1,7)
	at 15" (375)			17 (1,2)	40 (12)	
	at 18" (450)			13 (0,9)	30 (9)	
	at 21" (525)			13 (0,9)	30 (9)	
	at 24" (600)			11 (0,76)	25 (7,6)	

 **WARNING: Plugs must be braced while in use.**

404428	24" - 42" (600 - 1050)	22.5" (570)	42.5" (1080)	See chart below*	25 (1,7)
	at 24" (600)			15 (1,0)	35 (11)
	at 30" (750)			13 (0,9)	30 (9)
	at 30" DI (750)			13 (0,9)	30 (9)
	at 36" (900)			11 (0,76)	25 (7,6)
	at 42" (1050)			9 (0,62)	20 (6,1)
404608	40" - 60" (1000 - 1525)	38" (965)	60.5" (1537)	See chart below*	25 (1,7)
	at 40" - 42" (1000 - 1050)			15 (1,0)	35 (11)
	at 42" (1050)			15 (1,0)	35 (11)
	at 48" (1225)			13 (0,9)	30 (9)
	at 54" (1375)			11 (0,76)	25 (7,6)
	at 60" (1525)			8.7 (0,6)	20 (6,1)
	at 60" DI (1525)			8.7 (0,6)	20 (6,1)

Part #	Size Usage Range			Maximum Allowable Back Pressure			Required Inflation Pressure PSI (bar)
	Nominal Size Inches (mm)	Minimum Diameter Inches (mm)	Maximum Diameter Inches (mm)	Air Pressure PSI (bar)	Head Pressure Feet (Meters)		
i-series™ Muni-Ball® Plugs							
355088	4" - 8" (100 - 200)	3.75" (95)	8.25" (210)	13 (0,9)	30 (9,1)		30 (2,1)
355128	6" - 12" (150 - 300)	5.75" (145)	12.25" (310)	13 (0,9)	30 (9,1)		30 (2,1)
355168	8" - 16" (200 - 400)	7.7" (196)	16.25" (413)	13 (0,9)	30 (9,1)		30 (2,1)
355248	12" - 24" (300 - 600)	11.25" (286)	24.25" (616)	13 (0,9)	30 (9,1)		30 (2,1)
355488	24" - 48" (600 - 1200)	20.5" (521)	50" (1270)	SEE DATA BELOW			22 (1,5)
	at 24" (600)			15 (1,0)	35 (11)		
	at 30" (750)			13 (0,9)	30 (9,1)		
	at 36" (900)			12 (0,83)	28 (8,4)		
	at 42" (1050)			11 (0,76)	25 (7,6)		
	at 48" (1225)			10 (0,7)	23 (7)		
	at 48" DI (1225)			10 (0,7)	23 (7)		

 **WARNING: Plugs must be braced while in use.**

	30" - 60" (700 - 1500)	26.5" (675)	60.5" (1537)	SEE DATA BELOW	22 (1,5)
365608	at 30" (750)			15 (1,0) 35 (11)	
	at 36" (900)			15 (1,0) 35 (11)	
	at 42" (1050)			15 (1,0) 35 (11)	
	at 48" (1225)			13 (0,9) 30 (9,1)	
	at 48" DI (1225)			13 (0,9) 30 (9,1)	
	at 54" (1375)			12 (0,83) 28 (8,4)	
	at 60" (1500)			10 (0,7) 23 (7)	
365728	48" - 72" (1200 - 1800)	44" (1118)	72.25" (1835)	6 (0,41) 14 (4,3)	12 (0,83)
365968	54" - 96" (1400 - 2400)	54" (1400)	96.25" (2450)	6 (0,41) 14 (4,3)	11 (0,75)

Part #	Size Usage Range			Maximum Allowable Back Pressure		Required Inflation Pressure PSI (bar)
	Nominal Size Inches (mm)	Minimum Diameter Inches (mm)	Maximum Diameter Inches (mm)	Air Pressure PSI (bar)	Head Pressure Feet (Meters)	
i-series™ Test-Ball® Plugs						
395088	4" - 8" (100-200)	3.6" (92)	8.25" (210)	13 (0.9)	30 (9.1)	30 (2,1)
395128	6" - 12" (150-300)	5.75" (145)	12.25" (310)	13 (0.9)	30 (9.1)	30 (2,1)
395168	8" - 16" (200-400)	7.5" (186)	16.25" (413)	13 (0.9)	30 (9.1)	30 (2,1)
395248	12" - 24" (300 - 600)	11" (279)	24.25" (616)	13 (0.9)	30 (9.1)	30 (2,1)
395488	24" - 48" (600 - 1200)	20.5" (521)	50" (1270)	SEE DATA BELOW	SEE DATA BELOW	22 (2,5)
	at 24" (600)			15 (1,0)	35 (11)	
	at 30" (750)			13 (0,9)	30 (9,1)	
	at 36" (900)			12 (0,83)	28 (8,4)	
	at 42" (1050)			11 (0,76)	25 (7,6)	
	at 48" (1225)			10 (0,7)	23 (7)	
	at 48" DI (1 225)			10 (0,7)	23 (7)	
375608	30" - 60" (700 - 1500)	26.5" (675)	60.5" (1537)	SEE DATA BELOW	SEE DATA BELOW	22 (2,5)
	at 30" (750)			15 (1,0)	35 (11)	
	at 36" (900)			15 (1,0)	35 (11)	
	at 42" (1050)			15 (1,0)	35 (11)	
	at 48" (1225)			13 (0,9)	30 (9,1)	
	at 48" DI (1 225)			13 (0,9)	30 (9,1)	

 **WARNING: Plugs must be braced while in use.**

	at 54" (1375)			12 (0.83)	28 (8.4)	
	at 60" (1500)			10 (0.7)	23 (7)	
375728	48" - 72" (1200 - 1800)	44" (1118)	72.25" (1835)	6 (0.41)	14 (4.3)	12 (0.83)
375968	54" - 96" (1400 - 2400)	54" (1400)	96.25" (2450)	6 (0.41)	14 (4.3)	11 (0.75)

		Size Usage Range			Maximum Allowable Back Pressure		
Part #	Nominal Size Inches (mm)	Minimum Diameter Inches (mm)	Maximum Diameter Inches (mm)	Air Pressure PSI (bar)	Head Pressure Feet (Meters)	Required Inflation Pressure PSI (bar)	
Shorter Length i-series™ Test-Ball® Plugs							
385168	8" - 16" (200-400)	7.5" (186)	16.25" (413)	7.5 (0.5)	16.75 (5.1)	30 (2,1)	
385248	12" - 24" (300 - 600)	11" (279)	24.25" (616)	7.5 (0.5)	16.75 (5.1)	30 (2,1)	

 **WARNING: Plugs must be braced while in use.**

Part #	Nominal Size Inches (mm)	Size Usage Range			Maximum Allowable Back Pressure			Required Inflation Pressure PSI (bar)
		Minimum Diameter Inches (mm)	Maximum Diameter Inches (mm)	Air Pressure PSI (bar)	Head Pressure Feet (Meters)			
Air-Loc® Leak Locator Plugs (Front Plug)								
267068	6" - 10" (150 - 250)	5.5" (140)	10.3" (260)	13 (0,9)	30 (9)	30 (2,1)		
267088	8" - 12" (200 - 300)	7" (178)	12.3" (312)	13 (0,9)	30 (9)	30 (2,1)		
267128	12" - 18" (300 - 450)	10.75" (273)	18.8" (478)	13 (0,9)	30 (9)	25 (1,7)		
401308	15" - 30" (375 - 750)	14.5" (368)	30.5" (775)	See chart below*			25 (1,7)	
	at 15" (375)			17 (1,2)	40 (12)			
	at 18" (450)			13 (0,9)	30 (9)			
	at 21" (525)			13 (0,9)	30 (9)			
	at 24" (600)			11 (0,76)	25 (7,6)			
	at 30" (750)			11 (0,76)	25 (7,6)			
401428	24" - 42" (600 - 1050)	22.5" (570)	42.5" (1080)	See chart below*			25 (1,7)	
	at 24" (600)			15 (1,0)	35 (11)			
	at 30" (750)			13 (0,9)	30 (9)			
	at 30" DI (750)			13 (0,9)	30 (9)			
	at 36" (900)			11 (0,76)	25 (7,6)			
	at 42" (1050)			9 (0,62)	20 (6,1)			

 **WARNING: Plugs must be braced while in use.**

401608	40" - 60" (1000 - 1525)	38" (965)	60.5" (464)	See chart below*	25 (1,7)
	at 42" (1050)			15 (1,0)	35 (11)
	at 42" DI (1050)			15 (1,0)	35 (11)
	at 48" (1225)			13 (0,9)	30 (9)
	at 54" (1375)			11 (0,76)	25 (7,6)
	at 60" (1525)			8.7 (0,6)	20 (6,1)
	at 60" DI (1525)			8.7 (0,6)	20 (6,1)

Part #	Nominal Size Inches (mm)	Size Usage Range			Maximum Allowable Back Pressure		Required Inflation Pressure PSI (bar)
		Minimum Diameter Inches (mm)	Maximum Diameter Inches (mm)	Air Pressure PSI (bar)	Head Pressure Feet (Meters)		
Air-Loc® Leak Locator Plugs (Back Plug)							
275078	6" - 10" (150 - 250)	5.25" (133)	10.3" (260)	13 (0,9)	30 (9)	30 (2,1)	
275108	8" - 12" (200 - 300)	7" (178)	12.3" (312)	13 (0,9)	30 (9)	30 (2,1)	
275138	12" - 18" (300 - 450)	10.75" (273)	18.8" (478)	13 (0,9)	30 (9)	30 (2,1)	

 **WARNING: Plugs must be braced while in use.**

Part #	Nominal Size Inches (mm)	Size Usage Range			Maximum Allowable Back Pressure			Required Inflation Pressure PSI (bar)
		Minimum Diameter Inches (mm)	Maximum Diameter Inches (mm)	Air Pressure PSI (bar)	Head Pressure Feet (Meters)			
Factory-Replaceable Sleeve Muni-Ball® Plugs								
265110	6" - 12" (150 - 300)	5.7" (145)	12.6" (320)	See data below				
	at 6" (150)			22 (1,5)	50 (15)		45 (3,1)	
	at 8" (200)			20 (1,4)	45 (14)		45 (3,1)	
	at 10" (250)			17 (1,2)	40 (12)		45 (3,1)	
	at 12" (300)			13 (0,9)	30 (9)		45 (3,1)	
	at 12" DI (320)			13 (0,9)	30 (9)		45 (3,1)	
265138	12" - 21" (300 - 525)	10.75" (273)	21.5" (546)	See data below*				
	at 12" (300)			22 (1,5)	50 (15)		40 (2,8)	
	at 12" DI (320)			22 (1,5)	50 (15)		40 (2,8)	
	at 15"/16" (400)			20 (1,4)	45 (14)		40 (2,8)	
	at 18" (450)			17 (1,2)	40 (12)		40 (2,8)	
	at 21" (525)			13 (0,9)	30 (9)		40 (2,8)	
265144	16" - 24" (400 - 600)	14.75" (375)	25" (635)	See data below*				
	at 16" (400)			22 (1,5)	50 (15)		40 (2,8)	
	at 18" (450)			20 (1,4)	45 (14)		40 (2,8)	
	at 21" (525)			17 (1,2)	40 (12)		40 (2,8)	
	at 24" (600)			17 (1,2)	40 (12)		40 (2,8)	

 **WARNING: Plugs must be braced while in use.**

	at 24"DI (320)				13 (0,9)	30 (9)	40 (2,8)
265152	24" - 36" (600 - 900)	21.25" (540)	37.5" (953)	See data below*			
	at 24" (600)				22 (1,5)	50 (15)	40 (2,8)
	at 24"DI (320)				20 (1,4)	50 (15)	40 (2,8)
	at 30" (600)				20 (1,4)	45 (14)	40 (2,8)
	at 36" (600)				15 (1,0)	36 (11)	40 (2,8)
	at 36"DI (600)				11 (0,76)	25 (7,6)	40 (2,8)

Part #	Nominal Size Inches (mm)	Size Usage Range		Maximum Allowable Back Pressure			Required Inflation Pressure PSI (bar)
		Minimum Diameter Inches (mm)	Maximum Diameter Inches (mm)	Air Pressure PSI (bar)	Head Pressure Feet (Meters)		
Original Big-Mouth® Plugs							
269008	8" - 10" (200 - 250)	7.25" (185)	10.25" (260)	11 (0,76)	25 (7,6)	35 (2,4)	
269018	10" - 12" (250 - 300)	9.25" (235)	12.25" (311)	11 (0,76)	25 (7,6)	30 (2,1)	
269028	12" - 15" (300 - 380)	10.62" (270)	15.25" (387)	11 (0,76)	25 (7,6)	30 (2,1)	

 **WARNING: Plugs must be braced while in use.**

Part #	Nominal Size Inches (mm)	Size Usage Range		Maximum Allowable Back Pressure			Required Inflation Pressure PSI (bar)
		Minimum Diameter Inches (mm)	Maximum Diameter Inches (mm)	Air Pressure PSI (bar)	Head Pressure Feet (Meters)		
Single-Size Big-Mouth® Plugs							
369068	6" (150)	5.69" (145)	6.34" (161)	11 (0.76)	25 (7.6)	30 (2.1)	
369088	8" (200)	7.75" (195)	8.45" (215)	11 (0.76)	25 (7.6)	30 (2.1)	
369108	10" (250)	9.75" (250)	10.46" (266)	11 (0.76)	25 (7.6)	30 (2.1)	
369128	12" (300)	11.75" (300)	12.52" (318)	11 (0.76)	25 (7.6)	30 (2.1)	
369158	15" (375)	13.9" (353)	15.56" (395)	11 (0.76)	25 (7.6)	30 (2.1)	
369188	18" (450)	16.88" (429)	18.74" (476)	11 (0.76)	25 (7.6)	30 (2.1)	
369218	21" (525)	20.01" (508)	21.81" (554)	11 (0.76)	25 (7.6)	30 (2.1)	
369248	24" (600)	22.63" (575)	24.98" (634)	11 (0.76)	25 (7.6)	30 (2.1)	

 **WARNING: Plugs must be braced while in use.**

Part #	Nominal Size Inches (mm)	Size Usage Range			Maximum Allowable Back Pressure			Required Inflation Pressure PSI (bar)
		Minimum Diameter Inches (mm)	Maximum Diameter Inches (mm)	Air Pressure PSI (bar)	Head Pressure Feet (Meters)			
Multi-Size Big-Mouth® Plugs								
374068	6" - 10" (150 - 250)	5.75" (146)	10.25" (260)	10 (0,69)	23 (10)	40 (2,8)		
374088	8" - 12" (200 - 300)	7" (178)	12.25" (311)	15 (1,0)	34 (10,5)	35 (2,4)		
376088								
376128	12" - 18" (300 - 450)	11.25" (286)	18.25" (464)	10 (0,69)	23 (10)	25 (1,7)		
378128								
376148	14" - 21" (375 - 525)	13.6" (345)	21.25" (540)	10 (0,69)	23 (10)	25 (1,7)		
378148								
380148								
376188	18" - 24" (450 - 600)	16.5" (419)	24.25" (616)	10 (0,69)	23 (10)	22 (1,5)		
378188								
380188								
376248	24" - 36" (600 - 900)	21.75" (552)	36.25" (921)	10 (0,69)	23 (10)	20 (1,4)		
378248								
380248								

 **WARNING: Plugs must be braced while in use.**

Part #	Size Usage Range			Maximum Allowable Back Pressure			Required Inflation Pressure PSI (bar)
	Nominal Size Inches (mm)	Minimum Diameter Inches (mm)	Maximum Diameter Inches (mm)	Air Pressure PSI (bar)	Head Pressure Feet (Meters)		
Large Single-Size Muni-Ball® Plugs: Pillow-Style*							
266027	30" (750)	29.4" (747)	31.25" (794)	11 (0.76)	25 (7.6)	18 (1.24)	
266035	33" (850)	32.3" (819)	34.25" (870)	8.7 (0.61)	20 (6.1)	13 (0.9)	
266043	36" (900)	35.3" (896)	37.5" (953)	8.7 (0.61)	20 (6.1)	13 (0.9)	
266051	42" (1100)	41.2" (1045)	43" (1111)	7.8 (0.55)	18 (5.5)	12 (0.83)	
266078	48" (1200)	47.04" (1195)	50" (1270)	5.6 (0.4)	13 (4)	12 (0.83)	
266086	54" (1400)	52.92" (1344)	56" (1422)	5.6 (0.4)	13 (4)	10 (0.7)	
266094	60" (1600)	58.8" (1494)	62" (1575)	5.6 (0.4)	13 (4)	10 (0.7)	
266108	66" (1700)	64.7" (1643)	68" (1727)	3.5 (0.24)	8 (2.4)	8 (0.55)	
Part #	Size Usage Range			Maximum Allowable Back Pressure			Required Inflation Pressure PSI (bar)
	Nominal Size Inches (mm)	Minimum Diameter Inches (mm)	Maximum Diameter Inches (mm)	Air Pressure PSI (bar)	Head Pressure Feet (Meters)		
Multi-Size Rubber Test-Ball® Plug: Pillow Style							
301118	54" - 72" (1400 - 1800)	53.5" (1360)	72.25" (1842)	4.5 (0.3)	10 (3.2)	7.5 (0.5)	

 **WARNING: Plugs must be braced while in use.**

Part #	Nominal Size		Size Usage Range		Maximum Allowable Back Pressure			Required Inflation Pressure
	Inches (mm)	Inches (mm)	Minimum Diameter Inches (mm)	Maximum Diameter Inches (mm)	Air Pressure PSI (bar)	Head Pressure Feet (Meters)	PSI (bar)	
Large Single-Size Test-Ball® Plugs: Pillow-Style**								
277108	15" (375)*		14.7" (373)	15.5" (394)	15 (1)	35 (11)	35 (2,4)	
277118	18" (450)*		17.8" (451)	18.8" (477)	15 (1)	35 (11)	30 (2,1)	
277128	20" (500)*		19.6" (498)	20.7" (526)	13 (0,9)	30 (9,1)	18 (1,24)	
277134	21" (525)*		20.6" (523)	21.8" (554)	13 (0,9)	30 (9,1)	18 (1,24)	
277142	24" (600)*		23.5" (598)	25.2" (641)	11 (0,76)	25 (7,6)	18 (1,24)	
277150	27" (700)*		26.5" (672)	28.2" (717)	11 (0,76)	25 (7,6)	18 (1,24)	
277169	30" (750)		29.4" (747)	31.25" (794)	11 (0,76)	25 (7,6)	18 (1,24)	
277177	33" (850)		32.3" (819)	34.25" (870)	8.7 (0,61)	20 (6,1)	13 (0,9)	
277185	36" (900)		35.3" (896)	37.5" (953)	8.7 (0,61)	20 (6,1)	13 (0,9)	
277193	42" (1100)		41.2" (1045)	43.7" (1111)	7.8 (0,55)	18 (5,5)	12 (0,83)	
277207	48" (1200)		47.04" (1195)	50" (1270)	5.6 (0,4)	13 (4)	12 (0,83)	
277215	54" (1400)		52.92" (1344)	56" (1422)	5.6 (0,4)	13 (4)	10 (0,7)	
277223	60" (1500)		58.8" (1494)	62" (1575)	5.6 (0,4)	13 (4)	10 (0,7)	
277231	66" (1700)		64.7" (1643)	68" (1727)	3.5 (0,24)	8 (2,4)	8 (0,55)	

 **WARNING: Plugs must be braced while in use.**

17. SPECIAL USAGE INSTRUCTIONS FOR GRAVITY FLOW BYPASS APPLICATIONS

A. PREPARATION BEFORE USE

- Read, understand and follow all the warnings and instructions outlined in this Safety Instruction Manual before proceeding.
- Determine the pipe size to be blocked and the required back pressure. Select the properly sized Big Mouth® Flow Through plug(s) for the pipe (refer to chart on page 46).
- Select bypass adapter(s) for the plug(s) and a bypass hose assembly of suitable length for the application. Attach the adapter(s) to the Big Mouth® Flow Through Plug bypass tube using a suitable pipe sealant. Attach the bypass hose assembly to the plug(s) and pull down the locking tabs to secure the hose to the plug.
- Select a Poly Lift Line(s) with internal inflation hose of proper length to allow plug inflation and deflation from outside the Danger Zone. Attach the Poly Lift Line(s) to the plug(s).

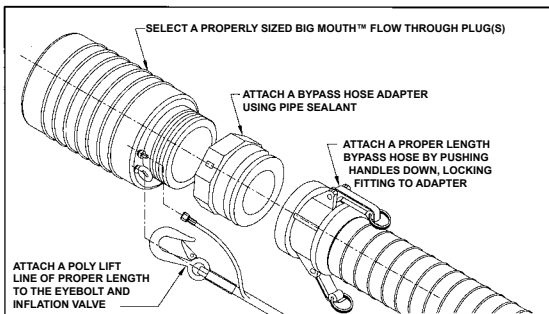

B. PLUG PLACEMENT

- Place the plugs into the pipeline a minimum distance of one pipeline diameter (refer to Section 10 of this manual).
- Construct a backup system as required for the installation (refer to Section 11 of this manual).

c. Inflate the plug from outside the Danger Zone (as fully described in Section 12 of this manual) to the pressure shown on the plug (the proper inflation pressure is also outlined in the chart on page 46).

d. Proceed with the planned maintenance or other selected task. Make sure that no one enters into the Danger Zone during plug use even if the plug is not restraining back pressure.

TYPICAL BIG MOUTH® FLOW THROUGH PLUG INSTALLATION

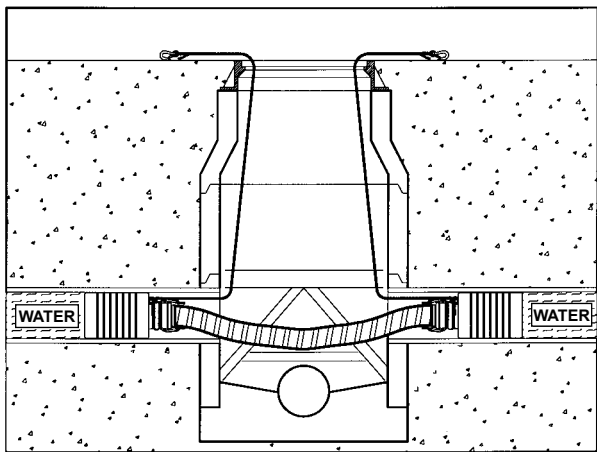

C. PLUG REMOVAL

a. Totally deflate the plug(s) through the inflation extension hose of the attached Poly Lift Line(s). (Deflate the downstream plug first!)

b. Remove the plugs from the pipe by pulling on the woven rope of the Poly Lift Line(s).

c. Clean, inspect and properly store the plugs for future use as outlined in this manual. Ensure a copy of this Safety Instruction Manual is kept with the plug for future use.

18. LIMITED WARRANTY

Manufacturer warrants all pneumatic plugs manufactured by it and shown in this manual will be free from defects in material and workmanship for two (2) years following the date of manufacture. If any of the goods are found to be defective, such goods will, at manufacturer's option be replaced or repaired at manufacturer's cost. The parties hereto expressly agree that buyer's sole and exclusive remedy against the manufacturer shall be for the repair and/or replacement of defective goods as provided herein. (The sole purpose of the stipulated exclusive remedy shall be to provide the buyer with free repair and replacement of defective goods in the manner provided herein. The exclusive remedy shall not be deemed to have failed of its essential purpose so long as the manufacturer is willing and able to repair or replace defective goods in the prescribed manner.) Goods which may be sold by manufacturer but are not manufactured by it are not warranted by manufacturer, but are sold only with the warranties, if any, of the original manufacturers thereof. (This warranty does not cover labor or other costs or expenses to remove or install any defective, repaired or replaced goods.) Manufacturer's warranty does not apply to any goods which have been subjected to misuse, mishandling, misapplication, neglect (including but not limited to use of unauthorized parts or attachments), or adjustment or repair performed by anyone other than manufacturer or one of manufacturer's authorized agents.

Any claim by buyer with reference to the goods sold hereunder shall be deemed waived by the buyer unless submitted in writing to manufacturer within the earlier of (1) thirty (30) days following the date buyer discovered or by reasonable inspection should have discovered, any claimed breach of the foregoing warranty, or (2) twenty-five (25) months following the date of manufacture. Any cause of action for breach of the foregoing warranty shall be brought within one year from the date the alleged breach was discovered or should have been discovered, whichever comes first.

LIMITATION OF LIABILITY. Manufacturer's liability (whether under the theories of breach of contract or warranty, negligence, or strict liability) for its goods shall be limited to repairing or replacing parts found by the manufacturer to be defective, or at manufacturer's option, to refunding the purchase price of such goods or parts thereof.

DISCLAIMER OF CONSEQUENTIAL DAMAGES. In no event shall manufacturer be liable for consequential damages arising out of or in connection with this agreement, including without limitation breach of any obligation imposed on manufacturer hereunder or in connection herewith. Consequential damages for purposes hereof shall include, without limitation (including death) to any person, or loss or damage to property (including without limitation property handled or processed by the use of the goods). Buyer shall indemnify manufacturer against all liability, cost or expense which may be sustained by manufacturer on account of any such loss, damage or injury.

DEFECTIVE PRODUCTS POLICY. To obtain performance under this warranty, any product suspected of having a manufacturing defect in materials or workmanship at manufacturers request must be returned to CHERNE INDUSTRIES INCORPORATED, freight prepaid, for inspection. A returned goods authorization (RGA) must be obtained before shipping any product back to CHERNE. Call 1-800-843-7584 and ask for customer service.

CUSTOMER TRANSPORTATION REIMBURSEMENT. Whenever CHERNE repairs or replaces a product at CHERNE'S expense, CHERNE will reimburse the distributor by credit memo, the same surface freight amount it cost CHERNE to return the warranty items.

The foregoing warranty is in lieu of all other warranties express or implied, including those of merchantability or fitness for any purpose not expressly set forth herein. No affirmation of manufacturer, by words or action, other than as set forth in this language shall constitute a warranty.



CHERNE INDUSTRIES INCORPORATED
5700 LINCOLN DRIVE
MINNEAPOLIS, MINNESOTA 55436-1695 U.S.A.

Phone: **1-800-THE-PLUG** (843-7584)
Fax: 1-800-843-7585