

Content

1. Introduction.....	1
2. Precautions.....	1
3.Product Introduction	
3-1 Specifications & Features.....	1
3-2 Front Panel.....	2
3-2-1 Display.....	2
3-2-2 Keyboard.....	4
3-3 Rear Panel.....	5
3-4 Power supply.....	5
4. Installation	
4-1 Load cell connection.....	6
4-2 Assembly Description of Upright Pole.....	6
5. Setting Mode	
5-1 Maximum Weighing Capacity & Division Setting.....	7
5-2 Function Setting.....	8
5-3Description of Parameter Values.....	9
6. Calibration.....	11
7.Operation	
7-1 Weighing.....	12
7-2 Tare.....	12
7-3 Check Weighing.....	13
7-4 Simple Counting.....	14
7-5 Accumulation, Accumulation Display and Accumulation clear.....	15
8. Error message.....	15

1. Introduction

This manual contains installation and operation instructions for the JWI-700D /700S Series weighing indicator. Please read the manual completely before installation and operation.

2. Precautions

- Place the indicator on a flat and stable surface.
- Verify that the input voltage and the plug type matches the local AC power supply, see 3-4.
- Warm up for 15 minutes before using it the first time.
- Keep the indicator away from EMI noise, strong wind and vibration, which might cause incorrect reading.
- Avoid sudden temperature changes (suitable operating temperature is between $-5^{\circ}\text{C} \sim 40^{\circ}\text{C}$.)
- Disconnect the power supply when cleaning the indicator.
- Do not immerse the indicator in water or other liquids.
- Service should be performed by authorized personnel only.

3. Product Introduction

3-1 Specifications & Features

Specifications

Model	JWI-700D	JWI-700S
Input sensitivity	0.2uV/DIV	0.2uV/DIV
Input voltage range	-2mV to 20mV	-2mV to 20mV
Load cell excitation	3 D-size dry batteries	3 D-size dry batteries
System linearity	0.007% of full capacity	0.007% of full capacity
Input impedance	10M ohm or more	10M ohm or more
A/D conversion mode	$\Delta -\Sigma$	$\Delta -\Sigma$
A/D internal resolution	700,000 count	700,000 count
A/D conversion speed	10 times/second	10 times/second
External display resolution	15,000 count	15,000 count
Display	6 digits	6 digits
Power supply	3 D-size dry batteries (4.5V) Option: 6V/300mA adaptor	3 D-size dry batteries (4.5V) Option: 6V/300mA adaptor
Certification	CE	CE

Features

- Power-saving design, with auto-shut off function
- Backlit LCD display with prominent 30mm high digits
- Up to 1/15000 resolution
- Gross or net weight switchable
- Low battery indication
- Flexible unit switching: Kg, g, lb.oz, 台斤, pcs
- Adjustable stand for bench scale
- Weight accumulation max 99 pieces
- Manual tare, pre-tare, simple counting, check weighing and accumulation
- Adjustable filtering level for weighing under various conditions
- Suitable for a wide range of bases and load cells
- Adjustable capacities, resolutions and parameters
- Enclosed PVC dustproof cover
- CE approved

3-2 Front Panel

3-2-1 Display

JWI-700D

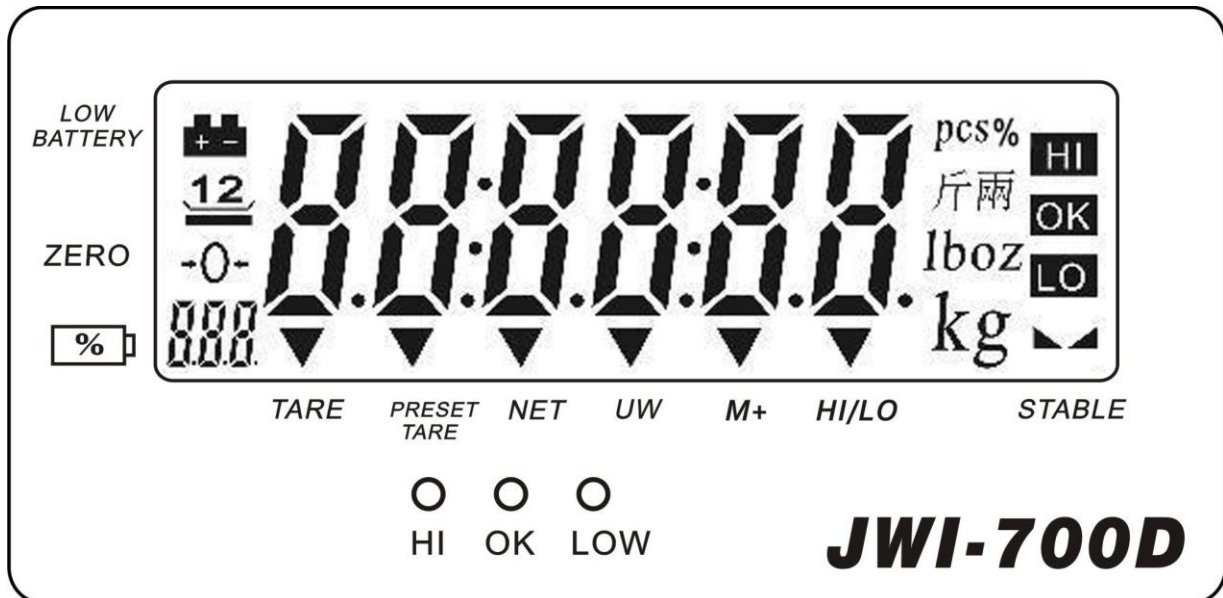

JWI-700S

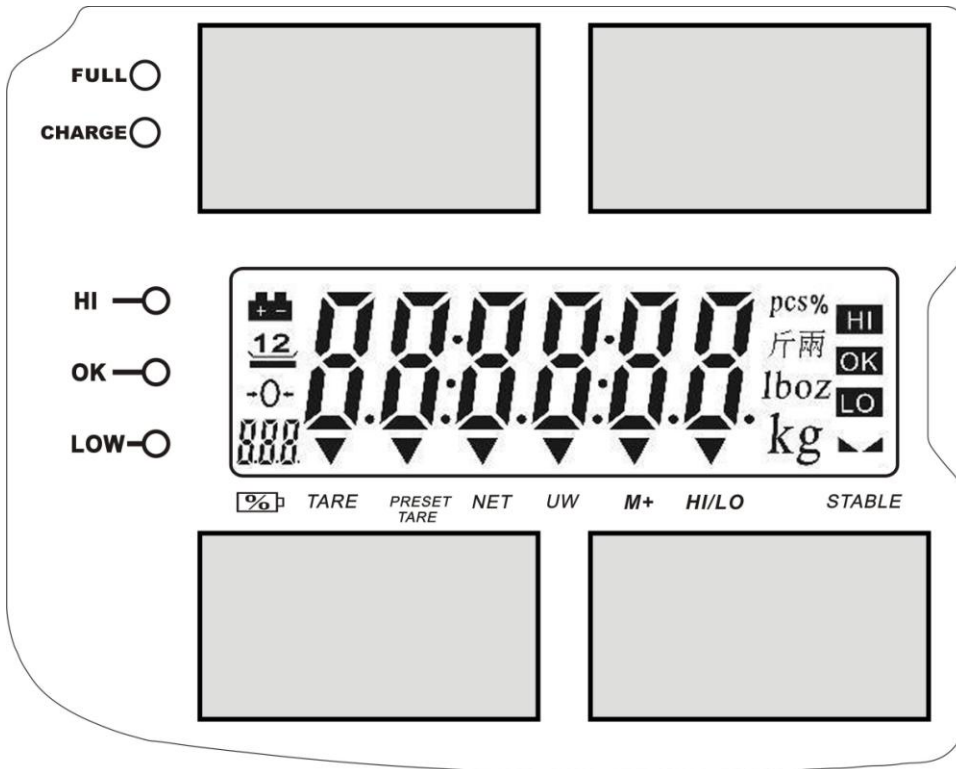

Low battery indication



Tare or Preset Tare Indication



Center of Zero Indication. The zeroing range is $\pm 2\%$ of scale capacity



Auxiliary display (battery power, parameter, accumulated number of weighments)

TARE Symbol “▼” points at “TARE” when the weight of the container is tared .

PRESET TARE Symbol “▼” points at “Preset Tare” when Tare value entered via keypad.

NET Net weight--Gross weight minus Tare. Symbol “▼” points at “NET” when Tare or Preset Tare action are done.

UW Symbol “▼” points at “UW” when calculated unit weight is lower than 4/5 of scale division. Unit weight is too small for ensuring accurate quantity calculations.

M+ Symbol “▼” points at “M+” when there is accumulation data

HI/LO Symbol “▼” points at “HI/LO” when check weighing function is on

FULL Charging finish

CHARGE Charging

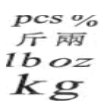

Units of measure

HI The weight on the weighing pan is greater than the upper limit(with HI lamp on)

OK The weight on the weighing pan is between upper and lower limits.(with OK lamp on)

- LO** The weight on the weighing pan is smaller than lower limit but over 20e. (with LOW lamp on)
 ▲▲ Stable indication

3-2-2 Keyboard

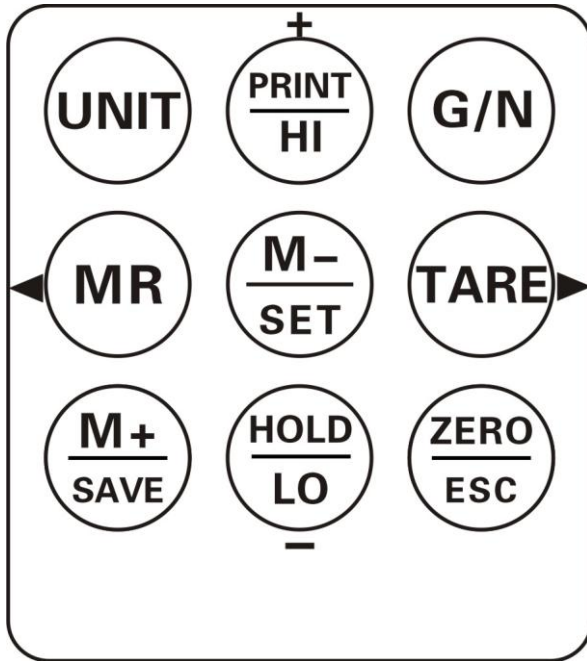

JWI-700D

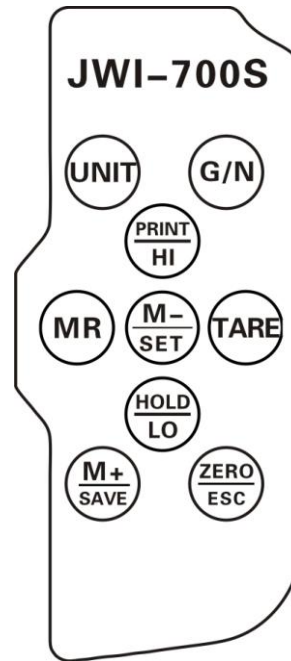

JWI-700S



	Short press steps through activated weighing units, release on desired one.
	<ol style="list-style-type: none"> 1. Displays gross and net weight by turns 2. When under simple counting mode, long press to enter sample quantity choose
	<ol style="list-style-type: none"> 1. Adds the indicated weight into accumulation memory 2. During editing, returns to the higher option 3. Save the settings
	<ol style="list-style-type: none"> 1. Zeros the display (within 2% of max.capacity) 2. Exits from certain operation without save
	<ol style="list-style-type: none"> 1. Enter parameter setting 2. Enable / Disable check weighing function 3. Deletes accumulation records
	<ol style="list-style-type: none"> 1. Tares the weight of the container or accepts the keypad tare entries 2. Shift keys rightwards when inputting the value

	<ol style="list-style-type: none"> 1. Memory recall 2. Shift keys leftwards when inputting the value
	<ol style="list-style-type: none"> 1. Select the former record when checking the accumulation record 2. Print out when connect to the printer 3. During setting value, add 1 to the current value 4. Set the upper limit of the check weighing
	<ol style="list-style-type: none"> 1. Select the later record when checking the accumulation record 2. Hold the weighing value 3. During setting value, deduct 1 to the current value 4. Set the lower limit of the check weighing

3-3Rear Panel

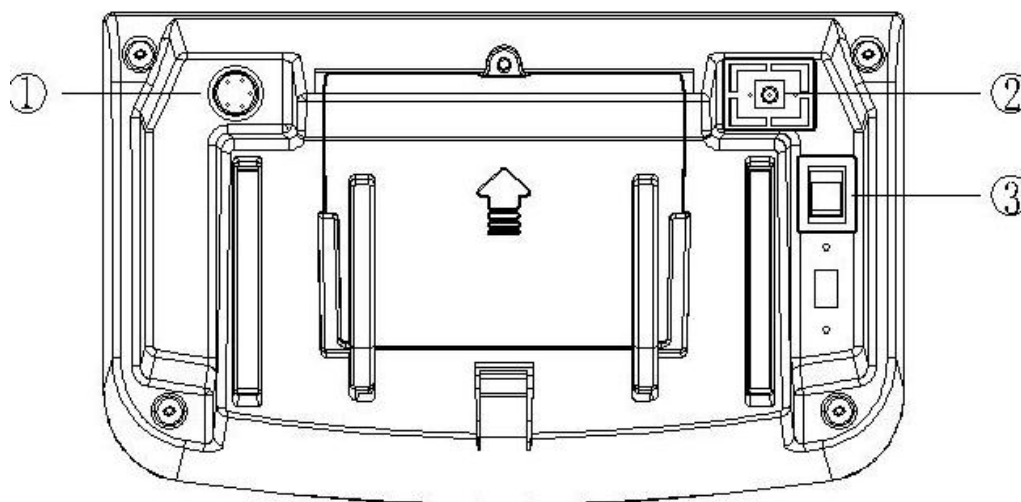

1. Port for connecting load cell.
2. Adaptor socket
3. Power ON/OFF switch

3-4 Power supply

JWI-700D Alternative power supply

- 1) 3 D-size dry batteries (4.5V)
- 2) 6V/300mA adaptor (Optional)

JWI-700S Alternative power supply

- 1) 4 pieces of solar energy panel
- 2) 3.7V/2000mA Li-ion battery
- 3) 6V/300mA adaptor (Optional)

Low battery warning

When “+ -” appears in the upper left corner of the weight window, the battery requires to be changed

4. Installation

4-1 Load cell connection

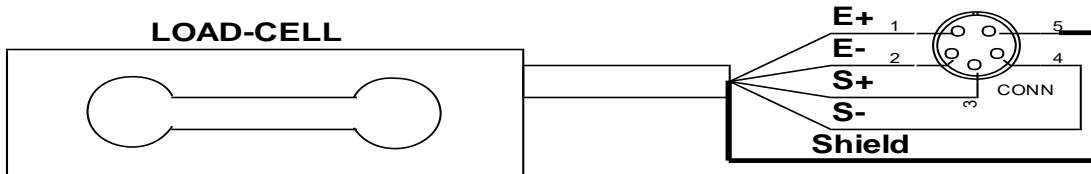

	<i>PIN</i>	<i>SIGNAL</i>
LOAD CELL CONNECTION	1	E+
	2	E-
	3	S+
	4	S-
	5	SHIELD

4-2 Assembly Description of Upright Pole

- (1) Rod seat
- (2) Upright pole
- (3) Racket
- (4) Indicator
- (5) Screw(for fixing the upright pole)
- (6) Screw(for fixing bracket)
- (7) Knob pole
- (8) Bracket slot
- (9) Load cell wire

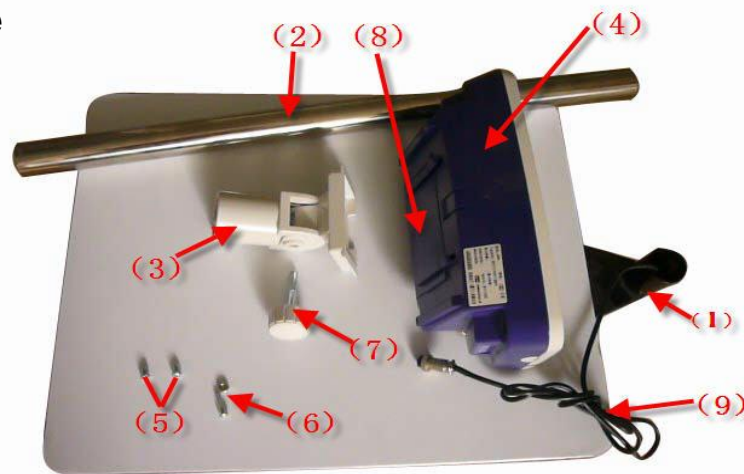

Step 1: Thread the wire of the Load Cell (9) on the rod seat (1) through the upright pole (2). Insert The upright pole into the rod seat and then Lock it with two screws (5).

Step 2: After threading the Load Cell wire Through the bracket (3), attach the bracket to the Upright pole and then lock it with the screw (6).

Note: if the load cell connector is too big to thread through the bracket, separate the bracket by removing the Knob pole (7), see the following pictures.



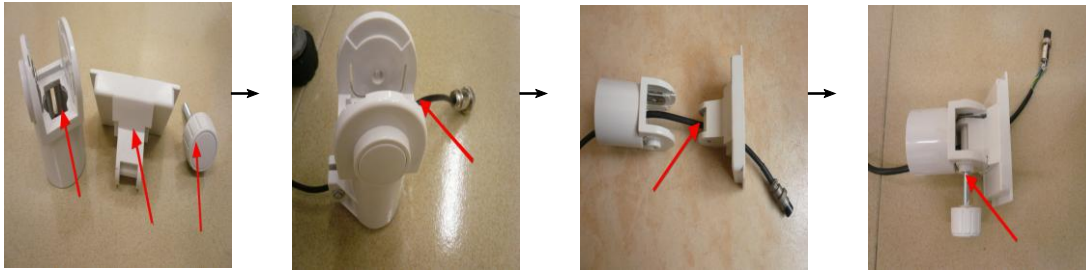

Step 3: Install the Indicator (4) on the bracket, with the bracket aligning with the bracket slot (8) of the indicator.



Step 4: After connecting load cell connector to load cell port, the installation is completed.



Note: Use the knob pole (7) to adjust the inclination angle of indicator and the screw (6) to adjust direction of the indicator. After adjusting the indicator to an optimal position, lock the screw.

5. Setting Mode

5-1 Maximum Weighing Capacity & Division Setting

1. Press and hold key **UNIT** and **M-/SET** while powering on the scale. When the window displays "**CAP**", release the key and it enters the capacity & division setting
2. Press **MR/◀** or **TARE/▶** to shift among "**CAP**" — capacity setting; "**DIV**" — division setting; "**accura**" — resolution check.
3. When the window is showing "**CAP**", press **M-/SET** to enter capacity setting.

Method1: Press **MR/◀** or **TARE/▶** to choose the general used capacity. Press **M+/SAVE** to save and return.

Method2: Press **M-/SET** to free-set the resolution. Press **UNIT** to choose the weighing unit
Press **MR/◀** or **TARE/▶** to shift key leftward or rightward. Press **+ /PRINT/HI** or
- /HOLD/LO to change the value. When move to the right-most, press **+ /PRINT/HI** or
- /HOLD/LO to move the decimal point. Press **M+ /SAVE** to save and return.

4. When the window is showing “**DIV**”, press **M-/SET** to check the division. Press **ZERO/ESC** to return.
5. When the window is showing “**accura**”, press **M-/SET** to enter resolution setting.

Method1: Press **MR/◀** or **TARE/▶** to choose the general used resolution. Press
M+ /SAVE to save and return.

Method 2: Press **M-/SET** to free-set the resolution. Press **MR/◀** or **TARE/▶** to shift key
leftward or rightward. Press **+ /PRINT/HI** or **- /HOLD/LO** to change the value. Press
M+ /SAVE to save and return.

6. Press **ZERO/ESC** to return to normal weighing mode.

5-2 Function Setting

1. Press and hold **M-/SET** while powering on or long press **M-/SET** under normal weighing mode to enter function setting. The window displays “**check**”. Setting item “**P00**” displays momentarily at the left bottom
2. Press **MR/◀** or **TARE/▶** to shift between the functions
3. Press **M-/SET** to enter the function parameter setting.
4. Press **MR/◀** or **TARE/▶** to shift between the function parameters
5. Press **M+ /SAVE** to save and return to higher option
6. Press **ZERO/ESC** to return to higher option without saving.
7. Press **ZERO/ESC** to return to normal weighing mode.

5-3 Description of Parameter Values

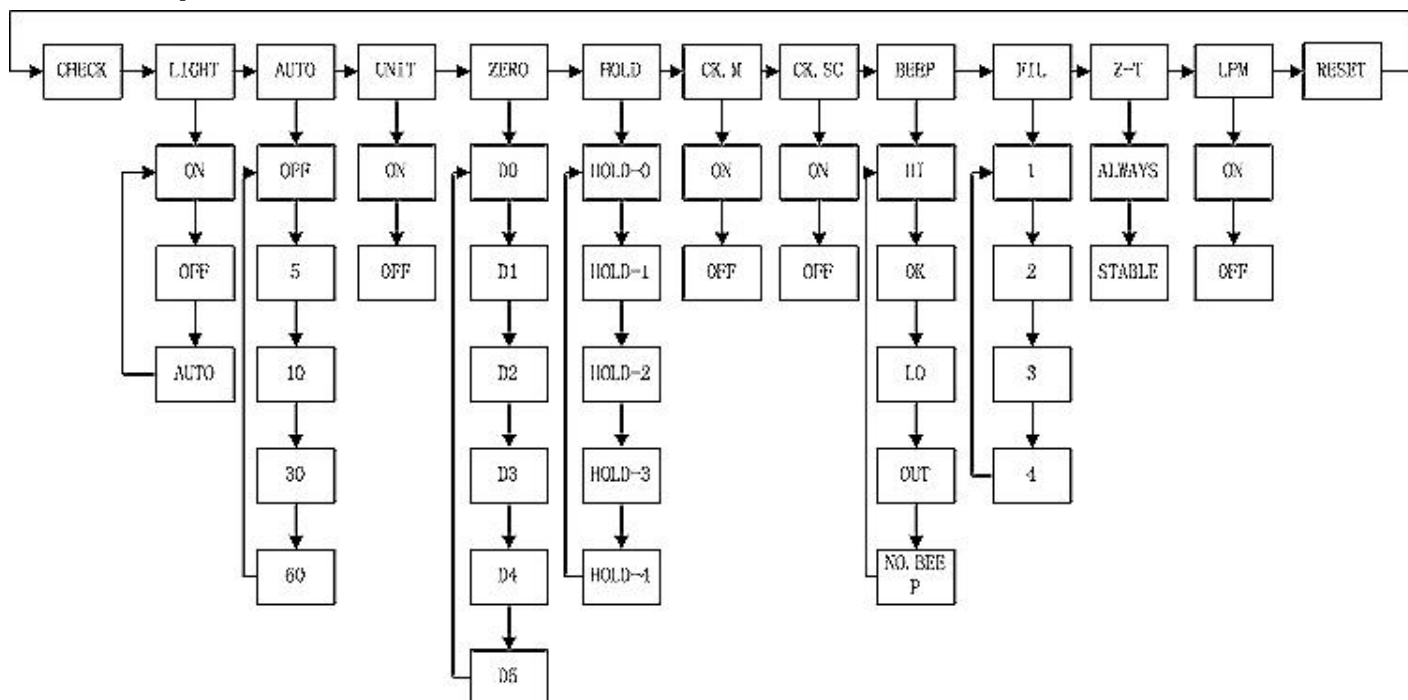

1. **CHECK** Offset value

Displays the offset value and the keypad testing can be conducted

2. **LIGHT** Backlight mode

Off : No backlight

Auto : Auto on with items greater than 9d placed on the weighing pan or any key is pressed.

But auto off after N seconds (N=2s, 5s, 10s, 20s, ever) with no action

Ever= It is always on when the weights over 9e

On : Backlight on

3. **AUTO** Auto-off

Off : Non power off

5 , **10** , **30** , **60**(minutes)

4. **UNIT** Unit setting

off select the unit : pcs , 斤 , lboz , g , kg

on : Enable the unit **off** : Disable the unit

Note: Press **UNIT** to choose the weighing unit. Press **MR/◀** or **TARE/▶** to enable / disable the unit

5. **ZERO** Zero range

d0, **d1**, **d2**, **d3**, **d4** and **d5**. (d= scale division)

6. **HOLD** Hold function

HoLd – 0: No hold function

HoLd – 1: Hold the peak weighing value. Press any key to release

HoLd – 2: Hold the weighing value after stable. Press any key to release

HoLd – 3: Hold the weighing value after stable. Move away the articles to release

HoLd – 4: Hold the weighing value while pressing down key **-/HOLD/LO**. Press any key to release

Note: the weight should be over 20d

7. **OFF** Check weighing memory

on : Check weighing function when restart the indicator is the same with that before powering off.

off : Check weighing function would not auto-on when restart the indicator

8. **LL** Stable Check Weighing

On: Check weighing after stable indicator appears and the weights is between the upper and lower limit

Off: Check weighing when the weights is between the upper and lower limit

9. **BEEP** Check Weighing buzzer beep

Hi : There will be a warning sound when the weight of articles exceeds the upper limit, and the weight is equal or more than 20d

LO: There will be a warning sound when the weight of articles exceeds the lower limit, and the weight is equal or more than 20 d

ok : There will be a warning sound when the weight of articles is between the upper and lower limit (including the upper and lower limits), and the weight is equal or more than 20d

out : There will be a warning sound when the weight of articles is beyond the upper & lower limit, and the weight is equal or more than 20d

no.beep : Three-stage check weighing(Buzzer in mute)

10. **F 1** Filtering setting

Set the filtering level in which the stable indication turns on. The higher the setting, the slower stabilization time

Options: **1** , **2** , **3** , **4**

11. **T-Z** Tare/Zero condition

stable : Only after the stable indication appears, Tare/Zero function acts after pressing down key **TARE** or **ZERO**

always : Tare/Zero function acts by pressing down key **TARE** or **ZERO** even if it is not stable

12. Power saving function

on: Enable the power saving function

off: Disable the power saving function

13. Initialization

Press **M-/SET**, then press **M+/SAVE** to start initialization. After the window displays “ok”, the initialization is finished

6. Calibration

Note: Before calibration, please set the unit first. The unit used in calibration is the one that has been set before. During the calibration procedure, press **ZERO/ESC** to return to normal weighing mode without saving.

Here we take 3kg/10g as an example

1. Press and hold **TARE** while powering on. Do not release it till the window displays “**CAL**”.
2. With no load on the weighing pan, press **TARE** to start zero point calibration. “**on 0**” is blanking at the left bottom.
3. Wait till the window displays the first calibration value. “**on 1**” appears at the left bottom.



Note: The first calibration value is default. If you need to change the value, do as the following:

Press **M-/SET** to enter the value setting. Press **MR/◀** or **TARE▶** to move the key leftwards or rightwards. Press **+ /PRINT/HI** or **- /HOLD/LO** to change the value. Press **M+/SAVE** to save.

4. Put the corresponding weight on the weighing pan, and then press **TARE** to complete the

first point calibration. “**on 2**” appears at the left bottom.

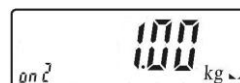

Note: After the first point calibration, the window can display the weight value. If no need for the other point calibration, move to step 6 to finish the calibration procedure.

5. Add another mass to the current weight. The window will show the total weight. Press **TARE**

to complete. “on 3” appears at the left bottom.

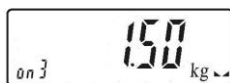

6. Press **M+/SAVE** to save. After the window displays “0000”, it will return to normal weighing mode.

7.Operation

7-1 Weighing

Begin with no load on the scale, the display reading zero. Place item(s) to be weighed on the scale. The display shown is the gross weight. (The desired weighing unit should be selected before weighing.)

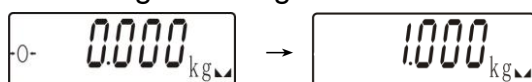

7-2 Tare

Manual Tare

When weighing a sample that must be held in a container, tare stores the container weight into memory.

1. Under the weighing mode, place the container on the weighing pan, wait till stable symbol appears, then press the key **TARE**. The container is tared.



2. Place the item(s) to be weighed into the container. The weight displayed is the net weight.



3. Remove all items from the weighing pan; the screen displays the tare value.



4. To clear tare with an empty pan, press down key **TARE** or key **ZERO/ESC**

Preset Tare

1. Long press key **TARE** for 3 seconds. The scale is now in digital inputting mode with the

left-most digit blinking.



2. Press **MR/◀** or **TARE▶** to move the key leftwards or rightwards; Press **+ /PRINT/HI** or **- /HOLD/LO** to change the value. E.g. here we set the Preset Tare value as

0.500kg



3. Press key **M+ /SET** to save and return to weighing mode.
4. Put the load on the container, the scale will automatically deduct the value of the container from the total value.
5. To clear tare with an empty pan, press down key **TARE** or key **ZERO/ESC**



7-3 Check Weighing

Lower limit setting

1. Begin by pressing down key **- /HOLD/LO**. It is now in digital inputting mode with the

left-most digit blinking.



2. To set the value of lower limit, press **MR/◀** or **TARE▶** to move the key leftwards or rightwards; Press **+ /PRINT/HI** or **- /HOLD/LO** to change the value.



3. Press **M- /SET** to enable / disable the check weighing function
4. Press **M+ /SAVE** to save the Lower limit and return to weighing mode

Upper limit setting

1. Begin by pressing down key **+ /PRINT/HI**. It is now in digital inputting mode with the

left-most digit blinking.



2. To set the value of lower limit, press **MR/◀** or **TARE▶** to move the key leftwards or



rightwards; Press **+ / PRINT / HI** or **- / HOLD / LO** to change the value



3. Press **M- / SET** to enable / disable the check weighing function
4. Press **M+ / SAVE** to save the Lower limit and return to weighing mode

Place the sample on the weighing pan, if the sample weight is under the lower weight range while over 20d, the LOW lamp will light up. If the sample is within the lower and upper weight range the OK lamp will light up. If the sample is over the upper weight range, the HI lamp will light up.

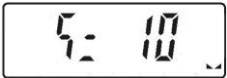
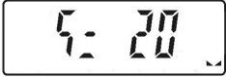
7-4 Simple Counting

1. Press key **UNIT** to select the unit "PCS". 
2. Press key **G / N**, the ex-factory default sample quantity (10 pcs) is displayed. 
3. Use key **+ / PRINT / HI** or **- / HOLD / LO** to choose the sampling amount. Available options are 10、20、50、100、200、500 (pieces). 
4. Put the corresponding samples on the weighing pan, and then press key **TARE**. "50.00" is displayed momentarily before the display reverts to the sample quantity.  → 
5. Remove the samples and put the load on, the scale calculates the amount of the load.
6. To go back to the normal weighing mode, remove the load and press key **UNIT** to select the proper weighing unit.

Note:

1. The larger the sample size, the more accurate unit weight.
2. Symbol "▼" points at "UW" when calculated unit weight is lower than 4 / 5 of scale division.

7-5 Accumulation, Accumulation Display and Accumulation clear

Accumulation

Under the weighing mode, put the item on the weighing pan. Press key **M+/SAVE** at the appearance of "▲▲". "00001" is displayed momentarily before the display reverts to the weight of the item.

Remove the item and the display goes back to zero before the next accumulation can register. (The maximum is 99 pieces, display the latest 10 accumulation events in details)

Accumulation Display

Press key **MR/◀** to display the accumulation data

MR/◀ or **TARE/▶** to check the total accumulation and each accumulation event in detail.

The number of weighments is indicated by Auxiliary display at the left bottom.

┌XX=Total accumulation ; ┐XX=certain accumulation

Accumulation Clear

To clear accumulation data (total accumulation data or one of the accumulation events), press key **M-/SET** while the data is displayed. To exit and return to normal weighing mode press key **ZERO/ESC**.

8. Error message

Error Message	Problem
ERR0	Exceed the zero range
ERR1	Model setting error. Resolution should be within 300-300000
ERR2	Exceed the initial zero point
ERR3	Exceed the A/D resolution range
ERR4	EEPROM failure
ERR5	Overload condition
ERR6	Exceeds the display range
ERR7	Accumulated number of weighments exceeds the display range
ERR8	Lower limit is higher than upper limit
ERR9	Exceed tare or pre-tare range
ERR10	Wrong calibration weights