

# Panasonic<sup>®</sup>

## Basic Operating Instructions Digital Camera

Model No. **DMC-FX75**

# LUMIX

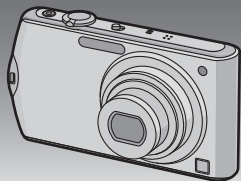

Before connecting, operating or adjusting this product,  
please read the instructions completely.



**Please also refer to the Operating  
Instructions (PDF format)  
contained on the CD-ROM  
(supplied).**



You can learn about advanced operation methods  
and check the Troubleshooting.

For USA and Puerto Rico assistance, please call: 1-800-211-PANA(7262) or,  
contact us via the web at: <http://www.panasonic.com/contactinfo>

**Dear Customer,**

***Thank you for choosing Panasonic!***

You have purchased one of the most sophisticated and reliable products on the market today. Used properly, we're sure it will bring you and your family years of enjoyment. Please take time to fill in the information on the below. The serial number is on the tag located on the underside of your Camera. Be sure to **retain this manual** as your convenient Camera information source. Please note that the actual controls and components, menu items, etc. of your Digital Camera may look somewhat different from those shown in the illustrations in these Operating Instructions.

**Carefully observe copyright laws.**

- Recording of pre-recorded tapes or discs or other published or broadcast material for purposes other than your own private use may infringe copyright laws. Even for the purpose of private use, recording of certain material may be restricted.

Model No. \_\_\_\_\_

Serial No. \_\_\_\_\_



A lithium ion battery that is recyclable powers the product you have purchased. Please call 1-800-8-BATTERY for information on how to recycle this battery.

## Information for Your Safety

### **WARNING:**

TO REDUCE THE RISK OF FIRE, ELECTRIC SHOCK OR PRODUCT DAMAGE,

- DO NOT EXPOSE THIS APPARATUS TO RAIN, MOISTURE, DRIPPING OR SPLASHING AND THAT NO OBJECTS FILLED WITH LIQUIDS, SUCH AS VASES, SHALL BE PLACED ON THE APPARATUS.
- USE ONLY THE RECOMMENDED ACCESSORIES.
- DO NOT REMOVE THE COVER (OR BACK); THERE ARE NO USER SERVICEABLE PARTS INSIDE. REFER SERVICING TO QUALIFIED SERVICE PERSONNEL.

THE SOCKET OUTLET SHALL BE INSTALLED NEAR THE EQUIPMENT AND SHALL BE EASILY ACCESSIBLE.

### ■ Product identification marking

Product	Location
Digital camera	Bottom
Battery charger	Bottom

**FCC Note:**

This equipment has been tested and found to comply with the limits for a Class B digital device, pursuant to Part 15 of the FCC Rules. These limits are designed to provide reasonable protection against harmful interference in a residential installation. This equipment generates, uses, and can radiate radio frequency energy and, if not installed and used in accordance with the instructions, may cause harmful interference to radio communications. However, there is no guarantee that interference will not occur in a particular installation. If this equipment does cause harmful interference to radio or television reception, which can be determined by turning the equipment off and on, the user is encouraged to try to correct the interference by one or more of the following measures:

- Reorient or relocate the receiving antenna.
- Increase the separation between the equipment and receiver.
- Connect the equipment into an outlet on a circuit different from that to which the receiver is connected.
- Consult the dealer or an experienced radio/TV technician for help.

**FCC Caution:** To assure continued compliance, follow the attached installation instructions and use only shielded interface cables with ferrite core when connecting to computer or peripheral devices.

Any changes or modifications not expressly approved by the party responsible for compliance could void the user's authority to operate this equipment.

**Declaration of Conformity**

Trade Name: Panasonic  
Model No.: DMC-FX75  
Responsible party: Panasonic Corporation of North America  
One Panasonic Way, Secaucus, NJ 07094  
Support Contact: Panasonic Consumer Electronics Company  
1-800-211-PANA (7262)

This device complies with Part 15 of the FCC Rules. Operation is subject to the following two conditions: (1) This device may not cause harmful interference, and (2) this device must accept any interference received, including interference that may cause undesired operation.

## ■ About the battery pack

### **CAUTION**

Battery pack (Lithium ion battery pack)

- Use the specified unit to recharge the battery pack.
- Do not use the battery pack with equipment other than the specified unit.
- Do not get dirt, sand, liquids, or other foreign matter on the terminals.
- Do not touch the plug terminals (+ and –) with metal objects.
- Do not disassemble, remodel, heat or throw into fire.

If any electrolyte should come into contact with your hands or clothes, wash it off thoroughly with water.

If any electrolyte should come into contact with your eyes, never rub the eyes. Rinse eyes thoroughly with water, and then consult a doctor.

### **CAUTION**

Danger of explosion if battery is incorrectly replaced. Replace only with the same or equivalent type recommended by the manufacturer. Dispose of used batteries according to the manufacturer's instructions.

- Do not heat or expose to flame.
- Do not leave the battery(ies) in an automobile exposed to direct sunlight for a long period of time with doors and windows closed.

### **Warning**

Risk of fire, explosion and burns. Do not disassemble, heat above 60 °C (140 °F) or incinerate.

## ■ About the battery charger

### **CAUTION!**

**DO NOT INSTALL OR PLACE THIS UNIT IN A BOOKCASE, BUILT-IN CABINET OR IN ANOTHER CONFINED SPACE. ENSURE THE UNIT IS WELL VENTILATED. TO PREVENT RISK OF ELECTRIC SHOCK OR FIRE HAZARD DUE TO OVERHEATING, ENSURE THAT CURTAINS AND ANY OTHER MATERIALS DO NOT OBSTRUCT THE VENTILATION VENTS.**

### **Battery charger**

This battery charger operates on AC between 110 V and 240 V.

But

- In the U.S.A. and Canada, the battery charger must be connected to a 120 V AC power supply only.
- When connecting to an AC supply outside of the U.S.A. or Canada, use a plug adaptor to suit the AC outlet configuration.

### **■ Cautions for Use**

- Do not use any other AV cables except the supplied one.
- Always use a genuine Panasonic HDMI mini cable (RP-CDHM15, RP-CDHM30; optional).  
Part numbers: RP-CDHM15 (1.5 m) (5 feet), RP-CDHM30 (3.0 m) (10 feet)
- Do not use any other USB connection cables except the supplied one.

### **Keep this unit as far away as possible from electromagnetic equipment (such as microwave ovens, TVs, video games etc.).**

- If you use this unit on top of or near a TV, the pictures and/or sound on this unit may be disrupted by electromagnetic wave radiation.
- Do not use this unit near cell phones because doing so may result in noise adversely affecting the pictures and/or sound.
- Recorded data may be damaged, or pictures may be distorted, by strong magnetic fields created by speakers or large motors.
- Electromagnetic wave radiation generated by microprocessors may adversely affect this unit, disturbing the pictures and/or sound.
- If this unit is adversely affected by electromagnetic equipment and stops functioning properly, turn this unit off and remove the battery or disconnect AC adaptor (DMW-AC5PP; optional). Then reinsert the battery or reconnect AC adaptor and turn this unit on.

### **Do not use this unit near radio transmitters or high-voltage lines.**

- If you record near radio transmitters or high-voltage lines, the recorded pictures and/or sound may be adversely affected.

**-If you see this symbol-**

**Information on Disposal in other Countries outside the European Union**

This symbol is only valid in the European Union.  
If you wish to discard this product, please contact your local authorities or dealer and ask for the correct method of disposal.



# Contents

Information for Your Safety .....	3
Standard Accessories .....	9
Names of the Components .....	10
How to Use the Touch Panel .....	12
Charging the Battery .....	14
About the Built-in Memory/the Card .....	16
Inserting and Removing the Card (optional)/the Battery .....	17
Setting Date/Time (Clock Set).....	18
• Changing the Clock Setting .....	18
Setting the Menu .....	19
Selecting the [REC] Mode.....	20
Taking Pictures Using the Automatic Function	
<i>iA</i> :Intelligent Auto Mode).....	21
• Scene Detection.....	22
• AF Tracking Function.....	22
Recording Motion Picture.....	23
Playing Back Pictures ([NORMAL PLAY]) .....	24
Deleting Pictures .....	24
Reading the Operating Instructions (PDF format).....	25
Specifications.....	27
Digital Camera Accessory System.....	30
Digital Camera Accessory Order Form .....	31
Limited Warranty	
(ONLY FOR U.S.A. AND PUERTO RICO) .....	32



# Standard Accessories

Check that all the accessories are supplied before using the camera.  
Product numbers correct as of June 2010. These may be subject to change.

- 1 Battery Pack  
(Indicated as **battery pack** or **battery** in the text)  
Charge the battery before use.
- 2 Battery Charger  
(Indicated as **battery charger** or **charger** in the text)
- 3 USB Connection Cable
- 4 AV Cable
- 5 CD-ROM
  - Software:  
Use it to install the software to your PC.
  - Operating Instructions
- 6 Hand Strap
- 7 Battery Case
- 8 Stylus Pen

• SD Memory Card, SDHC Memory Card and SDXC Memory Card are indicated as **card** in the text.

• **The card is optional.**

**You can record or play back pictures on the built-in memory when you are not using a card.**

• For information about optional accessories, refer to the "Digital Camera Accessory System".

• If any accessories are lost, customers should contact Panasonic's parts department at 1 800 833-9626 for further information about obtaining replacement parts.

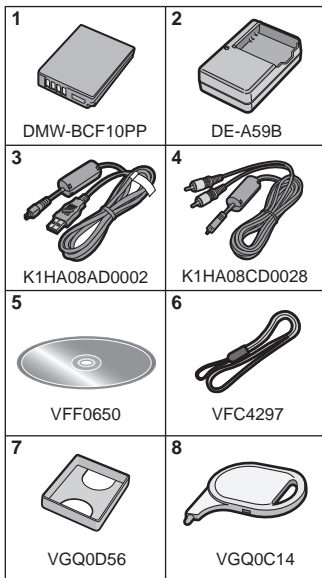

## Names of the Components

- 1 Flash
- 2 Lens
- 3 Self-timer indicator  
AF Assist Lamp
- 4 Hand strap eyelet
  - Be sure to attach the hand strap when using the camera to ensure that you will not drop it.
- 5 Touch panel/LCD monitor
- 6 [REC]/[PLAYBACK] selector switch
- 7 [MODE] button
- 8 [MENU] button

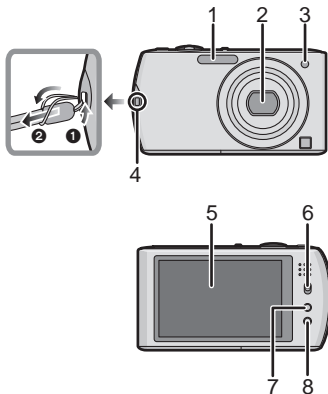

- 9 Camera ON/OFF switch
- 10 Zoom lever
- 11 Motion picture button
- 12 Speaker
- 13 Microphone
- 14 Shutter button

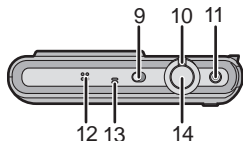

- 15 Lens barrel
- 16 [HDMI] socket
- 17 [AV OUT/DIGITAL] socket

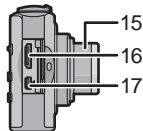

- 18 Tripod receptacle
  - When you use a tripod, make sure the tripod is stable when the camera is attached to it.
- 19 Card/Battery door
- 20 Release lever

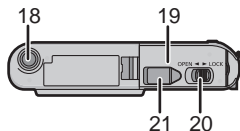

- 21 DC coupler cover
  - When using an AC adaptor, ensure that the Panasonic DC coupler (DMW-DCC4; optional) and AC adaptor (DMW-AC5PP; optional) are used.
  - Always use a genuine Panasonic AC adaptor (DMW-AC5PP; optional).
  - We recommend you use a battery with sufficient battery power or the AC adaptor when recording motion pictures.
  - If while recording motion pictures using the AC adaptor the power supply is cut off due to a power cut or if the AC adaptor is disconnected etc., the motion picture being recorded will not be recorded.

# How to Use the Touch Panel

This touch panel is a type that detects pressure.

Operation or settings are performed by directly touching the icons displayed on the LCD monitor (touch panel) or by moving while touching the touch panel (dragging) using your fingers or the supplied stylus pen.

## Touch the screen

To touch and release the touch panel.



Use this to perform tasks such as selecting icons or images displayed on the touch panel.

You can make settings by touching the items displayed on the screen.

You can exit without saving the settings by touching [CANCEL].

- It may not operate properly when multiple icons are touched simultaneously, so try to touch the center of the icon.

## Drag

A movement without releasing the touch panel.

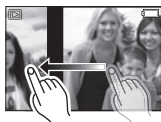

This is used when performing tasks such as moving to the next image by dragging horizontally, or changing the range of the displayed image.

This can also be used to perform tasks such as switching the screen by operating the slide bar.

- If you select wrong icon, you can drag to different icon, and it will select that icon by releasing the finger.

## Note

- The touch panel does not operate when the LCD monitor is turned off.
- If you use a commercially available liquid crystal protection sheet, please follow the instructions that accompany the sheet. (Some liquid crystal protection sheets may impair visibility or operability.)
- Apply a little extra pressure when touching if you have a commercially available protection sheet affixed or if you feel it is not responding well.
- Touch panel will not operate properly when the hand holding this unit is pressing on the touch panel.
- Do not press using anything with a sharp tip or anything hard, except for the supplied stylus pen.
- Do not operate with your fingernails.
- Wipe the LCD monitor with dry soft cloth when it gets dirty with finger prints and others.
- Do not scratch or press the LCD monitor too hard.

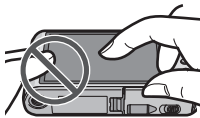

## ■ About the Stylus pen

It is easier to use the stylus pen (supplied) for detailed operation or if it is hard to operate with your fingers.

- Do not place it where small children can reach.
- Do not place the stylus pen on the LCD monitor when storing. LCD monitor may break when the stylus pen is pressed strongly against the LCD monitor.



## Charging the Battery

### ■ About batteries that you can use with this unit

The battery that can be used with this unit is DMW-BCF10PP.

It has been found that counterfeit battery packs which look very similar to the genuine product are made available to purchase in some markets. Some of these battery packs are not adequately protected with internal protection to meet the requirements of appropriate safety standards. There is a possibility that these battery packs may lead to fire or explosion. Please be advised that we are not liable for any accident or failure occurring as a result of use of a counterfeit battery pack. To ensure that safe products are used we would recommend that a genuine Panasonic battery pack is used.

- Use the dedicated charger and battery.
- The camera has a function for distinguishing batteries which can be used safely. The dedicated battery (DMW-BCF10PP) supports this function. The only batteries suitable for use with this unit are genuine Panasonic products and batteries manufactured by other companies and certified by Panasonic. (Batteries which do not support this function cannot be used). Panasonic cannot in any way guarantee the quality, performance or safety of batteries which have been manufactured by other companies and are not genuine Panasonic products.

### ■ Charging

- The battery is not charged when the camera is shipped. Charge the battery before use.
- Charge the battery with the charger indoors.
- It is recommended to charge the battery in a temperature between 10 °C to 30 °C (50 °F to 86 °F). (The battery temperature should also be the same.)

1

Attach the battery paying attention to the direction of the battery.

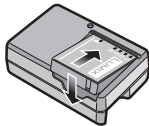

**2**

## Connect the charger to the electrical outlet.

- Disconnect the charger from the electrical socket and detach the battery after charging is completed.

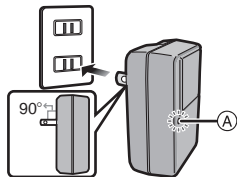

### ■ About the [CHARGE] indicator

#### The [CHARGE]

**indicator turns on:** The [CHARGE] indicator (A) is turned on and charging will start.

#### The [CHARGE]

**indicator turns off:** The [CHARGE] indicator (A) of the charger will turn off once the charging has completed without any problem.

### • When the [CHARGE] indicator flashes

- The battery temperature is too high or too low. It is recommended to charge the battery again in an ambient temperature of between 10 °C to 30 °C (50 °F to 86 °F).
- The terminals of the charger or the battery are dirty. In this case, wipe them with a dry cloth.

### ■ Charging time

<b>Charging time</b>	<b>Approx. 130 min</b>
----------------------	------------------------

### ■ Approximate operating time and number of recordable pictures

<b>Number of recordable pictures</b>	<b>Approx. 360 pictures</b>
<b>Recording time</b>	<b>Approx. 180 min</b>
<b>Playback time</b>	<b>Approx. 350 min</b>

### Recording conditions by CIPA standard

- CIPA is an abbreviation of [Camera & Imaging Products Association].
- Normal Picture Mode
- Temperature: 23 °C (73.4 °F)/Humidity: 50%RH when LCD monitor is on.
- Using a Panasonic SD Memory Card (32 MB).
- Using the supplied battery.
- Starting recording 30 seconds after the camera is turned on. (When the Optical Image Stabilizer function is set to [AUTO].)
- **Recording once every 30 seconds** with full flash every second recording.
- Rotating the zoom lever from Tele to Wide or vice versa in every recording.
- Turning the camera off every 10 recordings and leaving it until the temperature of the battery decreases.

# About the Built-in Memory/the Card

## Built-in Memory

- **Memory size: Approx. 40 MB**
- The built-in memory can be used as a temporary storage device when the card being used becomes full.
- The access time for the built-in memory may be longer than the access time for a card.

## Card

The following cards which conform to the SD video standard can be used with this unit.

(These cards are indicated as **card** in the text.)

Type of card which can be used with this unit	Remarks
SD Memory Card (8 MB to 2 GB)	<ul style="list-style-type: none"><li>• SDHC Memory Card can be used with SDHC Memory Card or SDXC Memory Card compatible equipment.</li><li>• SDXC Memory Card can only be used with SDXC Memory Card compatible equipment.</li><li>• Check that the PC and other equipment are compatible when using the SDXC Memory Cards. <a href="http://panasonic.net/avc/sdcard/information/SDXC.html">http://panasonic.net/avc/sdcard/information/SDXC.html</a></li></ul>
SDHC Memory Card (4 GB to 32 GB)	
SDXC Memory Card (48 GB, 64 GB)	

- Only cards bearing the SDHC logo (indicating that the card conforms to SD video standards) may be used as 4 GB to 32 GB cards.
- Only cards bearing the SDXC logo (indicating that the card conforms to SD video standards) may be used as 48 GB, 64 GB cards.
- Use a card with SD Speed Class\* with "Class 4" or higher when recording motion pictures in [AVCHD Lite]. Also, use a card with SD Speed Class with "Class 6" or higher when recording motion pictures in [MOTION JPEG].  
\* SD Speed Class is the speed standard regarding continuous writing.
- Please confirm the latest information on the following website.  
<http://panasonic.jp/support/global/cs/dsc/>  
(This Site is English only.)



### Note

- Keep the Memory Card out of reach of children to prevent swallowing.



# Inserting and Removing the Card (optional)/the Battery

- Check that this unit is turned off.
- We recommend using a Panasonic card.

**1** Slide the release lever in the direction of the arrow and open the card/battery door.

- Always use genuine Panasonic batteries (DMW-BCF10PP).
- If you use other batteries, we cannot guarantee the quality of this product.

**2** **Battery:** Insert until it is locked by the lever (A) being careful about the direction you insert it. Pull the lever (A) in the direction of the arrow to remove the battery.

**Card:** Push it fully until it clicks being careful about the direction you insert it. To remove the card, push the card until it clicks, then pull the card out upright.

(B): Do not touch the connection terminals of the card.

- The card may be damaged if it is not fully inserted.

**3** **1:** Close the card/battery door.

**2:** Slide the release lever in the direction of the arrow.

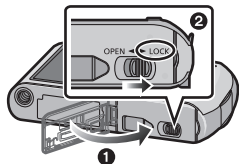
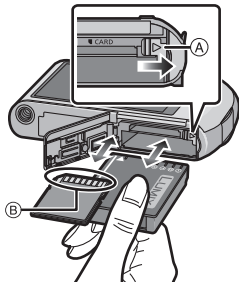
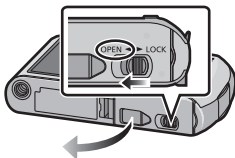

## Setting Date/Time (Clock Set)

- The clock is not set when the camera is shipped.

**1** Turn the camera on.



**2** Touch [CLOCK SET].



**3** Touch the items you wish to set (Year/ Month/Day/Hours/Minutes), and set using [▲]/[▼].

- Touch [CANCEL] to cancel the date and time settings without setting a date and time.



**4** Touch [SET] to set.

**5** Touch [SET].

- Touch [CANCEL] to return to the settings screen.



## Changing the Clock Setting

Select [CLOCK SET] in the [REC] or [SETUP] menu.

- It can be changed in steps **3** and **4** to set the clock.

# Setting the Menu

This section describes how to select the [REC] Mode menu settings, and the same setting can be used for the [MOTION PICTURE] Mode menu, [PLAYBACK] Mode menu and [SETUP] menu as well.

Example: Setting [AF MODE] from [ ] to [ ] in the Normal Picture Mode

**1** Press [MENU] to display the menu.



**2** Touch [AF MODE].

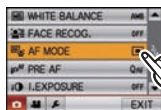

**3** Touch [ ].

- Depending on the item, its setting may not appear or it may be displayed in a different way.

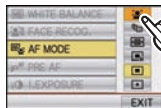

**4** Touch [EXIT] to close the menu.



## Switching to other menus

e.g.: Switching to the [SETUP] menu

Touch the [SETUP] menu icon [ ].

- Select a menu item next and set it.



## Selecting the [REC] Mode

### 1 Turn the camera on.

- (A) [REC]/[PLAYBACK] selector switch
- (B) [MODE] button

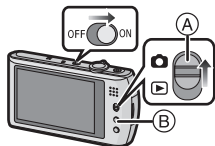

### 2 Slide the [REC]/[PLAYBACK] selector switch to [📷], and then press [MODE].

### 3 Touch the mode.

#### ■ List of [REC] Modes

##### **IA** [INTELLIGENT AUTO]

The subjects are recorded using settings automatically selected by the camera.

##### **📷** [NORMAL PICTURE]

The subjects are recorded using your own settings.

##### **👉** [COSMETIC MODE]

Takes a picture adjusting the skin texture.

##### **SCN** [SCENE MODE]

This allows you to take pictures that match the scene being recorded.

[REC] Mode: 

## Taking Pictures Using the Automatic Function (: Intelligent Auto Mode)

The camera will set the most appropriate settings to match the subject and the recording conditions so we recommend this mode for beginners or those who want to leave the settings to the camera and take pictures easily.

**1** Slide the [REC]/[PLAYBACK] selector switch to , and then press [MODE].

- (A) [REC]/[PLAYBACK] selector switch
- (B) [MODE] button
- (C) Shutter button

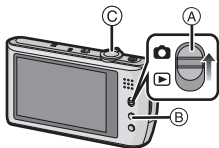

**2** Touch [INTELLIGENT AUTO].



**3** Hold this unit gently with both hands, keep your arms still at your side and stand with your feet slightly apart.

**4** Press the shutter button halfway to focus.



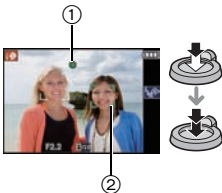





- The focus indication ① (green) lights when the subject is focused.
- The AF area ② is displayed around the subject's face by the Face Detection function. In other cases, it is displayed at the point on the subject which is in focus.
- The focus range is 3 cm (0.10 feet) (Wide)/1 m (3.28 feet) (Tele) to  $\infty$ .



**5** Press the shutter button fully (push it in further), and take the picture.

## Scene Detection

When the camera identifies the optimum scene, the icon of the scene concerned is displayed in blue for 2 seconds, after which its color changes to the usual red.

 →  [i-PORTRAIT]
 [i-SCENERY]
 [i-MACRO]
 [i-NIGHT PORTRAIT]
 [i-NIGHT SCENERY]
 [i-SUNSET]
 [i-BABY]

• Only when [i↔A] is selected

- [iA] is set if none of the scenes are applicable, and the standard settings are set.
- When [iP], [iN] or [iB] is selected, the camera automatically detects a person's face, and it will adjust the focus and exposure. **(Face Detection)**

## AF Tracking Function

It is possible to set the focus and exposure to the specified subject. Focus and exposure will keep following the subject automatically even if it moves.

### 1 Touch the subject.

- AF Tracking frame will be displayed in yellow, and it will determine the most appropriate scene for the locked subject.
- AF Tracking is cancelled when [CANCEL] is touched.



### 2 Press the shutter button halfway to focus and then press it fully to take the picture.

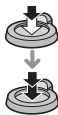

## Recording Motion Picture

This can record high definition motion pictures compatible with the AVCHD format or motion pictures recorded in Motion JPEG. Audio will be recorded in monaural.

**1** Slide the [REC]/[PLAYBACK] selector switch to , and then press [MODE].

- (A) Motion picture button
- (B) [REC]/[PLAYBACK] selector switch
- (C) [MODE] button



**2** Touch the mode.



**3** Start recording by pressing the motion picture button.

- (D) Available recording time
- (E) Elapsed recording time
- Release the motion picture button right after you press it.
- The recording state indicator (red) (F) will flash while recording motion pictures.

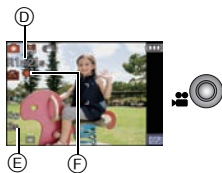

**4** Stop the recording by pressing the motion picture button again.

- If the built-in memory or the card becomes full in the middle of recording, the camera stops recording automatically.

### Note

- Motion picture recorded continuously in [MOTION JPEG] is up to 2 GB. Only the maximum recordable time for 2 GB is displayed on the screen.
- Maximum time to record motion pictures continuously with [AVCHD Lite] is 13 hours 3 minutes 20 seconds. Screen will only display up to 13 hours 3 minutes 20 seconds. However, the recording may stop before that depending on the remaining battery level.

[PLAYBACK] Mode: 

## Playing Back Pictures ([NORMAL PLAY])

- 1 Slide the [REC]/[PLAYBACK] selector switch  to .

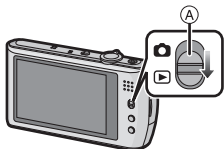

- 2 Forward or rewind the image by dragging the screen horizontally.

- After selecting the motion picture, touch  to start playback.



[PLAYBACK] Mode: 

## Deleting Pictures

**Once deleted, pictures cannot be recovered.**

- Pictures on the built-in memory or the card, that are being played back will be deleted.

- 1 Select the picture to be deleted, and then touch .



- 2 Touch [DELETE SINGLE].

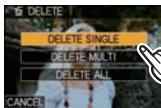

- 3 Touch [YES].



# Reading the Operating Instructions (PDF format)

- You have practised the basic operations introduced in these operating instructions and want to progress to advanced operations.
- You want to check the Troubleshooting.

In these kinds of situations refer to Operating Instructions (PDF format) contained on the CD-ROM (supplied).

## ■ For Windows

- 1** Turn the PC on and insert the CD-ROM containing the Operating Instructions (supplied).
- 2** Click the [Operating Instructions].
- 3** Select the desired language and then click [Operating Instructions] to install.  
(A) To return to the install menu.
- 4** Double click the “Operating Instructions” shortcut icon on the desktop.

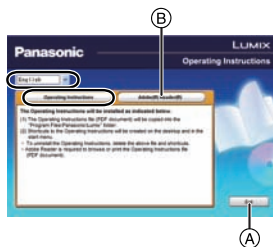

## ■ When the Operating Instructions (PDF format) will not open

You will need Adobe Acrobat Reader 5.0 or later or Adobe Reader 7.0 or later to browse or print the Operating Instructions (PDF format).

Insert the CD-ROM containing the Operating Instructions (supplied), click  and then follow the messages on the screen to install.

(Compatible OS: Windows 2000 SP4/Windows XP SP2 or SP3/Windows Vista SP1 or SP2/Windows 7)

- You can download and install a version of Adobe Reader that you can use with your OS from the following Web Site.

<http://get.adobe.com/reader/otherversions>

## ■ To uninstall the Operating Instructions (PDF format)

Delete the PDF file from the "Program Files\Panasonic\Lumix\" folder.

- When the contents in the Program Files folder cannot be displayed, click the [Show the contents of this folder] to display them.

## ■ For Macintosh

- 1** Turn the PC on and insert the CD-ROM containing the Operating Instructions (supplied).
- 2** Open the "Manual" folder in the CD-ROM and then copy the PDF file with the desired language inside the folder.
- 3** Double click the PDF file to open it.

## Specifications

**Digital Camera:** Information for your safety

**Power Source:** DC 5.1 V

**Power**

**Consumption:** 1.2 W (When recording)  
0.6 W (When playing back)

**Camera effective pixels:**

14,100,000 pixels

**Image sensor:**

1/2.33" CCD, total pixel number 14,500,000 pixels,  
Primary color filter

**Lens:**

Optical 5× zoom, f=4.3 mm to 21.5 mm (35 mm film camera equivalent: 24 mm to 120 mm)/F2.2 to F5.9  
Max. 4×

**Digital zoom:**

**Extended optical**

**zoom:**

Max. 10.5×

**Focus range:**

Normal: 50 cm (1.64 feet) (Wide)/1 m (3.28 feet) (Tele) to ∞  
Macro/Intelligent Auto:  
3 cm (0.10 feet) (Wide)/1 m (3.28 feet) (Tele) to ∞  
Scene Mode: There may be differences in the above settings.

**Shutter system:**

Electronic shutter+Mechanical shutter

<b>Burst recording</b>	
<b>Burst speed:</b>	Approx. 1.8 pictures/second
<b>Number of recordable pictures:</b>	Max. 5 pictures (Standard), max. 3 pictures (Fine).
<b>Hi-speed burst</b>	
<b>Burst speed:</b>	Approx. 10 pictures/second (Speed priority) Approx. 6 pictures/second (Image priority) [3M (4:3), 2.5M (3:2), 2M (16:9) or 2.5M (1:1) is selected as the picture size.]
<b>Number of recordable pictures:</b>	Approx. 15 to 100
<b>Shutter speed:</b>	8 seconds to 1/2000th of a second [STARRY SKY] Mode: 15 seconds, 30 seconds, 60 seconds
<b>Exposure (AE):</b>	Program AE Exposure compensation (1/3 EV Step, -2 EV to +2 EV)
<b>Metering mode:</b>	Multiple
<b>LCD monitor:</b>	3.0" TFT LCD (Approx. 230,000 dots) (field of view ratio about 100%) Touch panel
<b>Flash:</b>	Flash range: [ISO AUTO] Approx. 60 cm (1.97 feet) to 7.4 m (24.2 feet) (Wide)
<b>Microphone:</b>	Monaural
<b>Speaker:</b>	Monaural
<b>Recording media:</b>	Built-in Memory (Approx. 40 MB)/SD Memory Card/SDHC Memory Card/SDXC Memory Card
<b>Recording file format</b>	
<b>Still Picture:</b>	JPEG (based on "Design rule for Camera File system", based on "Exif 2.3" standard)/DPOF corresponding
<b>Pictures with audio:</b>	JPEG (based on "Design rule for Camera File system", based on "Exif 2.3" standard)+ "QuickTime"
<b>Motion pictures with audio:</b>	AVCHD Lite/QuickTime Motion JPEG

## Interface

<b>Digital:</b>	“USB 2.0” (High Speed)
<b>Analog video/ audio:</b>	NTSC Audio line output (monaural)

## Terminal

**[AV OUT/DIGITAL]:** Dedicated jack (8 pin)

**[HDMI]:** MiniHDMI TypeC

**Dimensions:** Approx. 102.5 mm (W)×55.0 mm (H)×22.8 mm (D)  
[4.04" (W)×2.17"(H)×0.9" (D)]  
(excluding the projecting parts)

**Mass (weight):** Approx. 165 g/0.36 lb (with card and battery)  
Approx. 144 g/0.32 lb (excluding card and battery)

## Operating

**temperature:** 0 °C to 40 °C (32 °F to 104 °F)

**Operating humidity:** 10%RH to 80%RH

**Language select:** [ENGLISH]/[ESPAÑOL]

## Battery Charger

(Panasonic

DE-A59B): Information for your safety

<b>Input:</b>	110 V to 240 V ~ 50/60 Hz, 0.2 A
<b>Output:</b>	4.2 V === 0.65 A

## Equipment





**mobility:** Movable

**Battery Pack  
(lithium-ion)**

(Panasonic  
DMW-BCF10PP): Information for your safety

<b>Voltage/capacity:</b>	3.6 V/940 mAh
--------------------------	---------------

# Digital Camera Accessory System

Accessory#	Illustration	Description
DMW-BCF10PP		Battery Pack
DMW-AC5PP		AC Adaptor*
DMW-DCC4		DC Coupler*
RP-CDHM15 RP-CDHM30		HDMI mini Cable
RP-SDW64GU1K RP-SDW48GU1K RP-SDW32GU1K RP-SDW16GU1K RP-SDW08GU1K RP-SDW04GU1K		Class 10 64 GB SDXC Memory Card Class 10 48 GB SDXC Memory Card Class 10 32 GB SDHC Memory Card Class 10 16 GB SDHC Memory Card Class 10 8 GB SDHC Memory Card Class 10 4 GB SDHC Memory Card
RP-SDP16GU1K RP-SDP08GU1K RP-SDP04GU1K RP-SDP02GU1K		Class 4 16 GB SDHC Memory Card Class 4 8 GB SDHC Memory Card Class 4 4 GB SDHC Memory Card Class 4 2 GB SD Memory Card
RP-SDR08GU1A RP-SDR04GU1A RP-SDR02GU1A		Class 2 8 GB SDHC Memory Card Class 2 4 GB SDHC Memory Card Class 2 2 GB SD Memory Card

Product numbers correct as of June 2010. These may be subject to change.

\* The AC Adaptor (optional) can only be used with the designated Panasonic DC Coupler (optional). The AC adaptor (optional) cannot be used by itself.

• NOTE: Accessories and/or model numbers may vary between countries. Consult your local dealer.

# Digital Camera Accessory Order Form

Please photocopy this form when placing an order.

1. Digital Camera Model # \_\_\_\_\_

2. Items Ordered

Accessory #	Description	Price Each	Quantity	Total Price
Subtotal				
Your State & Local Sales Tax				
Shipping & Handling				6.95
Total Enclosed				

3. Method of payment (check one)

- Check of Money Order enclosed (NO C.O.D.SHIPMENTS)
- VISA                      Credit Card # \_\_\_\_\_
- MasterCard              Expiration Date \_\_\_\_\_
- Discover                    Customer Signature \_\_\_\_\_

Make Check or Money Order to: PANASONIC ACCESSORIES

(Please do not send cash)

4. Shipping information (UPS delivery requires complete street address)

Ship To:

Mr.

Mrs.

Ms. \_\_\_\_\_

First

Last

Phone#:

Day ( ) \_\_\_\_\_

Street Address

Night ( ) \_\_\_\_\_

City

State

Zip

TO OBTAIN ANY OF OUR DIGITAL CAMERA ACCESSORIES YOU CAN DO ANY OF THE FOLLOWING:

VISIT YOUR LOCAL PANASONIC DEALER

OR

CALL PANASONIC'S ACCESSORY ORDER LINE AT 1-800-332-5368

[6 AM-6 PM M-F, PACIFIC TIME]

OR

MAIL THIS ORDER TO: PANASONIC SERVICE AND TECHNOLOGY COMPANY

ACCESSORY ORDER OFFICE

20421 84th Avenue South Kent, WA. 98032

# Limited Warranty (ONLY FOR U.S.A. AND PUERTO RICO)

**Panasonic Consumer Electronics Company,  
Division of Panasonic Corporation of North America**  
One Panasonic Way, Secaucus, New Jersey 07094

## **Panasonic Digital Still Camera Products Limited Warranty**

### **Limited Warranty Coverage (For USA and Puerto Rico Only)**

If your product does not work properly because of a defect in materials or workmanship, Panasonic Consumer Electronics Company (referred to as “the warrantor”) will, for the length of the period indicated on the chart below, which starts with the date of original purchase (“warranty period”), at its option either (a) repair your product with new or refurbished parts, (b) replace it with a new or a refurbished equivalent value product, or (c) refund your purchase price. The decision to repair, replace or refund will be made by the warrantor.

<b>Product or Part Name</b>	<b>Parts</b>	<b>Labor</b>
Digital Still Camera	1 year	1 year
CCD	6 months	90 days
SD Memory Cards, Rechargeable Battery Pack (defective exchange)	90 days	Not Applicable

During the “Labor” warranty period there will be no charge for labor. During the “Parts” warranty period, there will be no charge for parts. This Limited Warranty excludes both parts and labor for non-rechargeable batteries, antennas, and cosmetic parts (cabinet). This warranty only applies to products purchased and serviced in the United States or Puerto Rico. This warranty is extended only to the original purchaser of a new product which was not sold “as is”.



## **Mail-In Service**

For assistance in the U.S.A. and Puerto Rico in obtaining repairs, please ship the product prepaid to:

**Panasonic Exchange Center**  
**4900 George McVay Drive**  
**Suite B**  
**McAllen, TX 78503**  
**panacare@us.panasonic.com**

When shipping the unit, carefully pack, include all accessories, and send it prepaid, adequately insured and preferably in the original carton. If Lithium Ion batteries are shipped by air the package must be labeled "Contains Lithium Ion Battery (No lithium metal)". Damaged batteries are prohibited from shipment by US Mail. Batteries must be securely packed in a manner to prevent short-circuiting and a package cannot contain more than 3 Lithium Ion batteries. Include a letter detailing the complaint, a return address and provide a daytime phone number where you can be reached. A valid registered receipt is required under the Limited Warranty.

**IF REPAIR IS NEEDED DURING THE WARRANTY PERIOD, THE PURCHASER WILL BE REQUIRED TO FURNISH A SALES RECEIPT/PROOF OF PURCHASE INDICATING DATE OF PURCHASE, AMOUNT PAID AND PLACE OF PURCHASE. CUSTOMER WILL BE CHARGED FOR THE REPAIR OF ANY UNIT RECEIVED WITHOUT SUCH PROOF OF PURCHASE.**

## **Limited Warranty Limits And Exclusions**

This warranty ONLY COVERS failures due to defects in materials or workmanship, and DOES NOT COVER normal wear and tear or cosmetic damage. The warranty ALSO DOES NOT COVER damages which occurred in shipment, or failures which are caused by products not supplied by the warrantor, or failures which result from accidents, misuse, abuse, neglect, mishandling, misapplication, alteration, faulty installation, set-up adjustments, misadjustment of consumer controls, improper maintenance, power line surge, lightning damage, modification, introduction of sand, humidity or liquids, commercial use such as hotel, office, restaurant, or other business or rental use of the product, or service by anyone other than a Factory Service Center or other Authorized Servicer, or damage that is attributable to acts of God.

**THERE ARE NO EXPRESS WARRANTIES EXCEPT AS LISTED UNDER "LIMITED WARRANTY COVERAGE".**

**THE WARRANTOR IS NOT LIABLE FOR INCIDENTAL OR CONSEQUENTIAL DAMAGES RESULTING FROM THE USE OF THIS PRODUCT, OR ARISING OUT OF ANY BREACH OF THIS WARRANTY.**

(As examples, this excludes damages for lost time, travel to and from the servicer, loss of or damage to media or images, data or other memory or recorded content. The items listed are not exclusive, but for illustration only.)

**ALL EXPRESS AND IMPLIED WARRANTIES, INCLUDING THE WARRANTY OF MERCHANTABILITY, ARE LIMITED TO THE PERIOD OF THE LIMITED WARRANTY.**

Some states do not allow the exclusion or limitation of incidental or consequential damages, or limitations on how long an implied warranty lasts, so the exclusions may not apply to you.

This warranty gives you specific legal rights and you may also have other rights which vary from state to state. If a problem with this product develops during or after the warranty period, you may contact your dealer or Service Center. If the problem is not handled to your satisfaction, then write to the warrantor's Consumer Affairs Department at the addresses listed for the warrantor.

**PARTS AND SERVICE, WHICH ARE NOT COVERED BY THIS LIMITED WARRANTY, ARE YOUR RESPONSIBILITY.**

## **Customer Services Directory (United States and Puerto Rico)**

**Obtain Product Information and Operating Assistance; locate your nearest Dealer or Service Center; purchase Parts and Accessories; or make Customer Service and Literature requests by visiting our Web Site at:**

**<http://www.panasonic.com/help>**

**or, contact us via the web at:**

**<http://www.panasonic.com/contactinfo>**

You may also contact us directly at:

1-800-211-PANA (7262)

Monday-Friday 9am-9pm, Saturday-Sunday 10am-7pm EST

**For hearing or speech impaired TTY users, TTY: 1-877-833-8855**

## **Accessory Purchases (United States and Puerto Rico)**

Purchase Parts, Accessories and Instruction Books online for all Panasonic Products by visiting our Web Site at:

**<http://www.pstc.panasonic.com>**

Or, send your request by E-mail to:

**[npcparts@us.panasonic.com](mailto:npcparts@us.panasonic.com)**

You may also contact us directly at:

1-800-332-5368 (Phone) 1-800-237-9080 (Fax Only)

(Monday-Friday 9am-9pm EST)

Panasonic Service and Technology Company

20421 84th Avenue South, Kent, WA 98032

(We accept Visa, MasterCard, Discover Card, American Express, and Personal Checks)

**For hearing or speech impaired TTY users, TTY: 1-866-605-1277**

**As of November 2009**

- SDXC Logo is a trademark of SD-3C, LLC.
- The "AVCHD", "AVCHD Lite" and the "AVCHD", "AVCHD Lite" logo are trademarks of Panasonic Corporation and Sony Corporation.
- Manufactured under license from Dolby Laboratories.  
Dolby and the double-D symbol are trademarks of Dolby Laboratories.
- HDMI, the HDMI Logo, and High-Definition Multimedia Interface are trademarks or registered trademarks of HDMI Licensing LLC in the United States and other countries.
- VIERA Link™ is a trademark of Panasonic Corporation.
- EZ Sync™ is a trademark of Panasonic Corporation.
- HDAVI Control™ is a trademark of Panasonic Corporation.
- QuickTime and the QuickTime logo are trademarks or registered trademarks of Apple Inc., used under license therefrom.
- Microsoft product screen shot(s) reprinted with permission from Microsoft Corporation.
- Other names, company names, and product names printed in these instructions are trademarks or registered trademarks of the companies concerned.

This product is licensed under the AVC patent portfolio license for the personal and non-commercial use of a consumer to (i) encode video in compliance with the AVC Standard ("AVC Video") and/or (ii) decode AVC Video that was encoded by a consumer engaged in a personal and non-commercial activity and/or was obtained from a video provider licensed to provide AVC Video. No license is granted or shall be implied for any other use. Additional information may be obtained from MPEG LA, LLC. See <http://www.mpegla.com>.

**AVCHD** Lite™

**HDMI**

**VIERA** Link™

**DOLBY**  
DIGITAL  
CREATOR



Panasonic Consumer Electronics Company,  
Division of Panasonic Corporation of North America  
One Panasonic Way, Secaucus, NJ 07094

© Panasonic Corporation 2010

Printed in Japan