

Nikon

35 mm Film Scanner

LS-30

User's Guide

Cautions

- The reproduction of this manual in whole or in part is prohibited save in cases in which Nikon's prior permission has been obtained.
- The information contained in this manual is subject to change without notice.
- Nikon has made every effort to produce a perfect manual, but should you find any mistakes, we would be grateful if you would kindly let us know. The address of Nikon's representative in your area is provided separately.
- Nikon is not liable for damages resulting from the use of this product.



Symbol

The  symbols in this manual signify important safety precautions. All passages marked with this indication should be read prior to installation to prevent injury to yourself or to others. These indications are also placed in the table of contents to mark passages that should be read before use.



Symbol

The  symbols in this manual signify the need for caution when using the product. These indications are placed in sections that should be read before operation to prevent damage to the product.



Warning!

The CD-ROMs on which the software and manuals are distributed should not be played back on audio CD equipment. Playing CD-ROMs on an audio CD player could cause hearing loss or damage the equipment.

Trademark Information

Macintosh is a registered trademark of Apple Computer, Inc. Microsoft and Windows are registered trademarks, and Windows NT a trademark, of Microsoft corporation. IBM PC/AT is a trademark of International Business Machines Corporation. i386, i486, Pentium, and Pentium II are trademarks of Intel Corporation, U.S.A. Adobe and Acrobat are registered trademarks, and Photoshop a trademark, of Adobe Systems, Inc. The Clean Image function incorporated in the LS-30 makes use of Digital ICE technology developed by Applied Science Fiction Inc. Digital ICE and the Digital ICE logo are trademarks of Applied Science Fiction Inc. All other trade-names mentioned in this manual are the trademarks or registered trademarks of their respective holders.

Federal Communications Commission (FCC) Radio Frequency Interference Statement

This equipment has been tested and found to comply with the limits for a Class B digital device, pursuant to Part 15 of the FCC Rules. These limits are designed to provide reasonable protection against harmful interference in a residential installation. This equipment generates, uses, and can radiate radio frequency energy and, if not installed and used in accordance with the instructions, may cause harmful interference to radio communications. However, there is no guarantee that interference will not occur in a particular installation. If this equipment does cause harmful interference to radio or television reception, which can be determined by turning the equipment off and on, the user is encouraged to try to correct the interference by one or more of the following measures:

- Reorient or relocate the receiving antenna.
- Increase the separation between the equipment and receiver.
- Connect the equipment into an outlet on a circuit different from that to which the receiver is connected.
- Consult the dealer or an experienced radio/television technician for help.

CAUTIONS

Modifications

The FCC requires the user to be notified that any changes or modifications made to this device that are not expressly approved by Nikon Corporation may void the user's authority to operate the equipment.

SCSI Cable

Depending on your region, a SCSI cable or ferrite core is provided with your scanner. The SCSI cable used with your scanner must be that provided or must have the provided ferrite core attached. Using other interface cables may exceed the limits of the class B Part 15 of FCC rules.

Notice for customers in Canada

CAUTION

This class B digital apparatus meets all requirements of the Canadian Interference Causing Equipment Regulations.

ATTENTION

Cet appareil numérique de la classe B respecte toutes les exigences du Règlement sur le matériel brouilleur du Canada.

Notice for customers in European countries

ACHTUNG

Dieses Gerät entspricht den Bestimmungen der EG-Direktive 87/308/EEC zur Störungsunterdrückung. Lärmemission kleiner 70 dBA



Safety Precautions

Observe the following safety precautions when installing and operating the LS-30:

- **Do not allow your fingers, hair, or clothing into the film insertion slot**
Do not insert your fingers, hair, or clothing into the film insertion slot on the front of the scanner when the power is on and a film adaptor is in place. Doing so could result in injury.
- **Do not disassemble**
The interior of the scanner contains areas of high voltage. Removing the scanner's cover could result in fire or electric shock. Contact your dealer or Nikon service office for inspection or repair.
- **Do not modify**
Do not modify the equipment. Doing so could cause fire or electric shock.
- **Do not place heavy objects on the scanner**
- **Place on a stable surface**
Do not use the equipment on an unstable surface or on a surface which is not horizontal. This could cause the equipment to fall, resulting in injury.
- **Do not drop**
Do not subject the equipment to strong shocks, as this could cause malfunction or breakage. Note that the scanning unit contains glass parts; if the scanner is dropped, care should be taken to avoid contact with broken glass.
- **Keep clean**
Use a dry cloth to remove any dirt from metal sections of the scanner and their surroundings. Using the equipment when dirty could cause fire.

- **Do not place foreign objects inside the scanner**

Do not allow foreign objects of any kind into the unit. If flammable objects, metal, or water come in contact with the interior of the scanner, malfunction, fire, or electric shock could result.

- Do not place vases, flowerpots, cups, cosmetics, vessels containing chemicals or water, or small metal articles on top of the equipment. Should such articles or their contents fall into the equipment, fire, electric shock or malfunction could result.

- Exposing the scanner to volatile substances such as alcohol, benzine, thinner, or pesticides could cause malfunction, fire, or electric shock.

- If foreign substances or water should find their way into the equipment, turn off the power immediately, unplug the power cord and contact your dealer or nearest Nikon service office. Continued use could result in fire, electric shock or malfunction. Particular care is advised in households with small children.

- **When not using for an extended period**

When not using the equipment for an extended period, remove any film that may be in the adapters and take the adapters out of the adapter slot. Turn off the equipment and unplug the power cord. To prevent the accumulation of dust inside the equipment, close the front cover.

- **When performing routine maintenance**

Before performing maintenance, turn the equipment off and unplug the power cord.

- **If you notice smoke or an unusual noise or smell from the scanner**, turn off the power immediately and then unplug the power cord. Continued use could result in fire or electric shock. After ensuring that the equipment has stopped smoking, contact your dealer or Nikon service representative for information on replacement or repair. Do NOT attempt repairs yourself, as this would be extremely dangerous.

When transporting the scanner

The LS-30 is for use only in the country of sale. Nikon will not be held responsible for consequences resulting from use overseas.

The scanning mechanism must be locked in its home position for transport within the country. To return the scanning mechanism to its home position, remove any adapters from the adapter slot and then turn the scanner on. The status LED will blink while the scanning mechanism returns to the home position. Wait until the status LED glows steadily, then turn off and unplug the scanner. Place the guard in the adapter slot as shown below, sliding it in until it contacts the back of the slot.

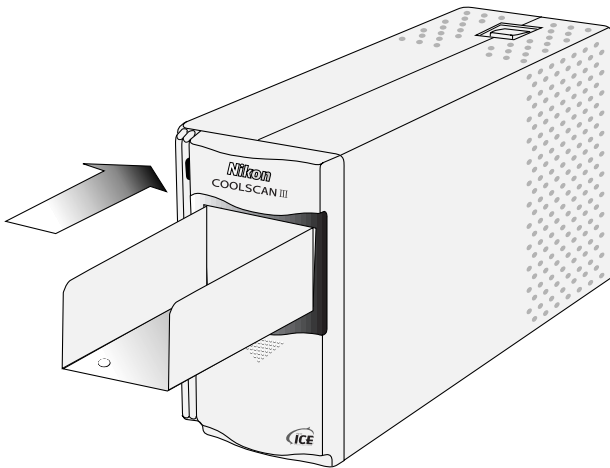

Remove the transport locking screws from the rear panel and screw them into the holes provided in the side panel and the mouth of the adapter slot (the hole in the mouth of the slot should align with the hole in the guard). Close the front cover and pack the scanner and adapters in the original packing material for transport.



Caution: *Do not transport the scanner without first locking the scanning mechanism with the transport lock screws. Moving the scanner without the lock screws in place could damage the mechanism.*

Notice concerning prohibition of copying or reproduction

Note that simply being in possession of material which has been copied or reproduced by means of a scanner may be punishable by law.

- **Items prohibited by law from being copied or reproduced**
Do not copy or reproduce paper money, coins, securities, government bonds, or local government bonds, even if such copies or reproductions are stamped “Sample.”



The copying or reproduction of paper money, coins, or securities which are circulated in a foreign country is prohibited.

Unless the prior permission of the government has been obtained, the copying or reproduction of unused postage stamps or post cards issued by the government is prohibited.

The copying or reproduction of stamps issued by the government and certified documents stipulated by law is prohibited.

- **Cautions on certain copies and reproductions**
The government has issued cautions on copies or reproductions of securities issued by private companies (shares, bills, checks, gift certificates, etc.), commuter passes, or coupon tickets, except when a minimum of necessary copies are to be provided for business use by a company. Also, do not copy or reproduce passports issued by the government, licenses issued by public agencies and private groups, ID cards, and tickets, such as passes and meal coupons.
- **Comply with copyright notices**
The copying or reproduction of copyrighted creative works such as books, music, paintings, woodcut prints, maps, drawings, movies, and photographs is prohibited except when it is done for personal use at home or for similar restricted and non-commercial use.



Contents

	Safety Precautions	iv
1.	Overview	1
2.	Parts and Accessories	3
2.1	What's in the Box	3
2.2	Parts of the LS-30	4
3.	Setup	5
	3.1 Setting up the LS-30	5
3.2	Software Installation	16
4.	Scanning	21
	Appendix: Nikon Scan Controls	31
	Menus, Tabs, and Information Displays	31
	Buttons	32
	Control Drawers	33
	Preferences	35

1. Overview

Thank you for your purchase of a Nikon LS-30 scanner for 35 mm film. The LS-30 is a high-speed, high-resolution scanner capable of producing images suited to a wide variety of tasks, including desktop publishing, design, and multi-media publishing. Its modular design allows you to change from scanning 35 mm slides to scanning 35 mm strip film “on the fly.” An adapter for scanning IX240 film is available separately. The LS-30 uses a high-speed SCSI interface for connection to computers running Mac OS System Software 7.1 or later, Windows 95 or later, or Windows NT 4.0 or later.

The scanner driver software provided with your scanner, Nikon Scan 2.1, offers sophisticated pre-scan editing of images, including precise color correction, contrast, and brightness adjustment. Nikon Scan can be launched from any TWAIN-compliant application under Windows or from any application that supports Adobe Photoshop plug-ins (version 4.0 or higher) on the Macintosh. Nikon Scan can also be used as a “stand-alone” application, allowing you to save scanned images to disk without the help of another application.

The user’s manuals for the LS-30 and Nikon Scan are divided into three parts. This *User’s Guide* offers a brief introduction to setting up the scanner and scanning images using Nikon Scan. More detailed reference manuals for the scanner and for Nikon Scan are provided on CD-ROM. To read these manuals you will need to install the Adobe Acrobat Reader software included on the reference CD. In addition, a one-page *Fast Track Guide* is provided for experienced users who want to get started with the minimum of instruction. Where appropriate, this guide will refer readers to the reference manuals or *Fast Track Guide* for more information. References to the manuals on CD are indicated by a  icon in the margin, references to the *Fast Track Guide* by a  icon.

1. Overview

The chapters that follow provide a step-by-step guide to installing your scanner and using Nikon Scan to scan 35 mm slides or strip film. The next chapter, *Parts and Accessories*, lists the things you should find packaged with your LS-30 and names the parts of the scanner. This is followed by “*Setup*,” which guides you through the process of connecting your scanner to a computer and installing Nikon Scan. “*Scanning*” outlines the steps involved in using Nikon Scan to scan slides and strip film. A separate reference section lists the controls available in Nikon Scan. We hope that you find this manual useful.

2. Parts and Accessories

This chapter lists the items you should find packaged with your LS-30 and names the parts of the scanner.

2.1 What's in the Box

Purchasers of the LS-30 should find that the package contains the items listed below. Should you find that anything is missing or damaged, contact your retailer immediately.



LS-30 Scanner main body (1)

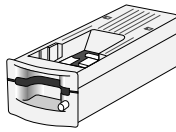

MA-20 SLIDE MOUNT ADAPTER (1)



FH-2 strip-film holder for MA-20 (1)

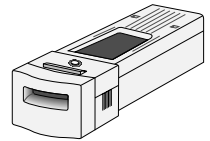

SA-20 STRIP FILM ADAPTER (1)



Power cable (1)
(shape of cable depends on country of sale)

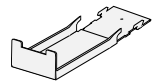

Film tray for SA-20 (1)



Scanner software CD-ROM for Windows and Macintosh (1)

Reference CD containing manuals and Adobe Acrobat Reader (1)

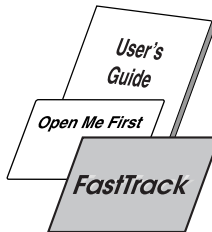

User's Guide (1) (this manual)
"Open Me First" envelope (1)
Fast Track guide (1)

Note: US customers should also find that the package contains a SCSI cable. Customers in other countries should find a ferrite core for attachment to a SCSI cable. See the reference manual for details.

2. Parts and Accessories

2.2 Parts of the LS-30

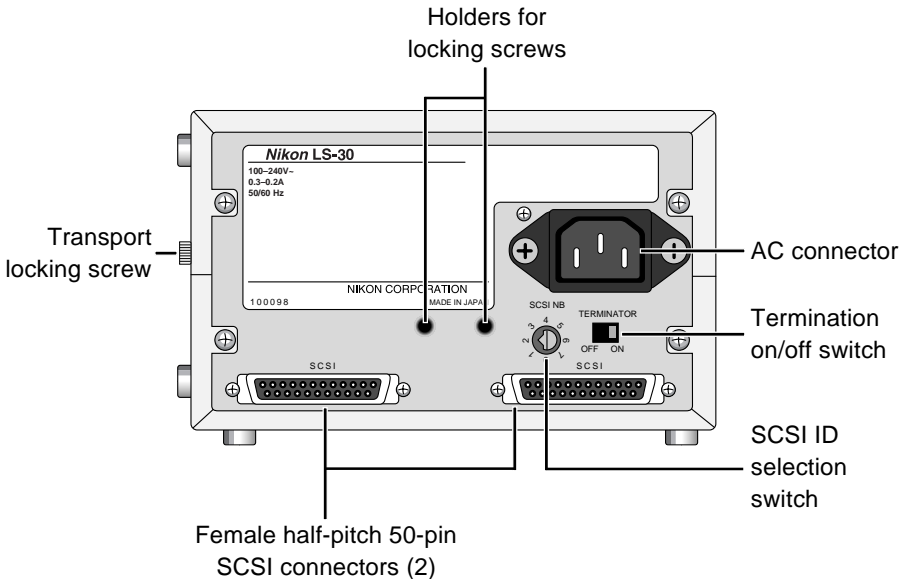
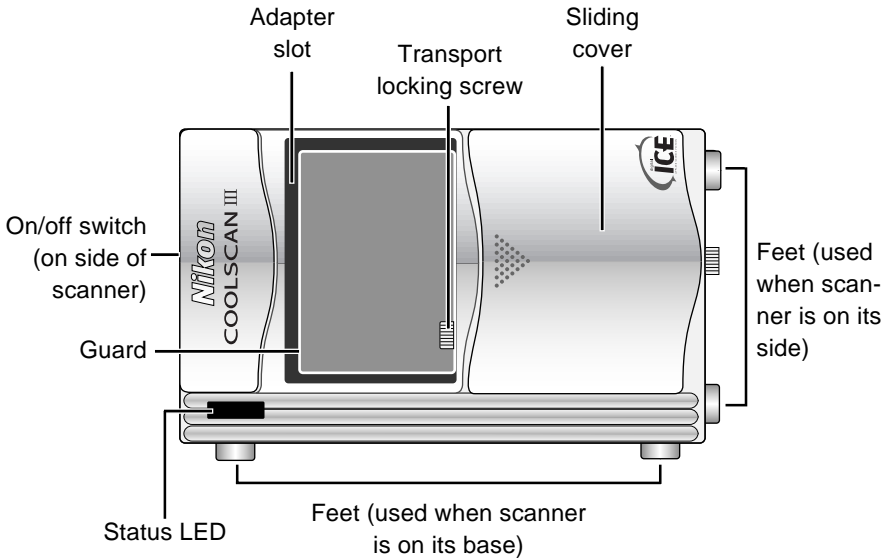

3. Setup

This chapter takes you step-by-step through the process of setting up the LS-30 and installing Nikon Scan.

3.1 Setting up the LS-30

This section outlines the steps involved in connecting the LS-30 to a computer. Before using your scanner, you will need to complete the following steps:

- select a suitable location for the scanner
- remove the transport locking screws
- connect the power and SCSI cables
- set the SCSI ID

Step 1—Choose a location for the scanner

Before connecting the LS-30 to your computer, choose a flat, stable location for it, free from vibration and dust. Do not install your scanner where:

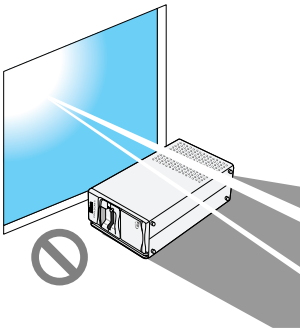

- it would be exposed to direct or reflected sunlight
- it would be subject to condensation or drastic changes in temperature
- it would be subject to radio interference from other electronic devices
- the temperature exceeds 35°C (95°F) or falls below 10°C (50°F)
- other objects would block the scanner's vents

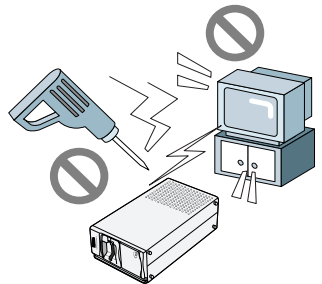

3. Setup

The scanner has feet both on its base and on one side, making it possible to place the scanner either on its base or on its side. When installing the scanner, leave enough space free for ease of operation. There should be at least 5 cm (2") of space above the unit, and 10 cm (4") behind. Space requirements are illustrated below.

When installing the scanner on its base

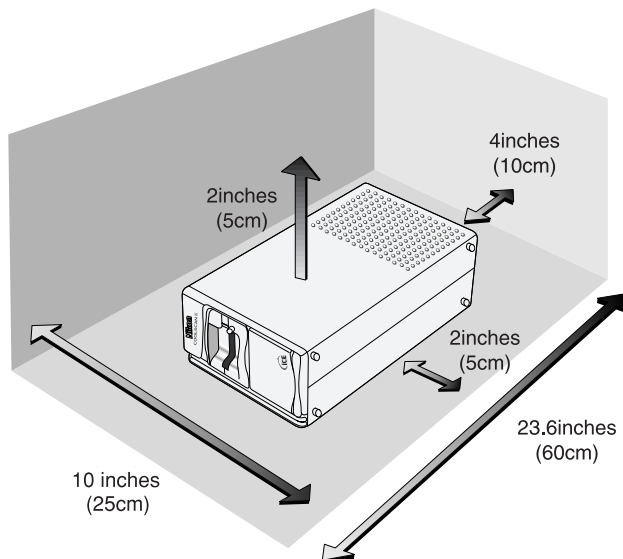

Caution: *The scanner must be installed with the feet down, as shown in the illustrations on these pages. Do not store or operate the scanner in any other orientation.*

When installing the scanner on its side

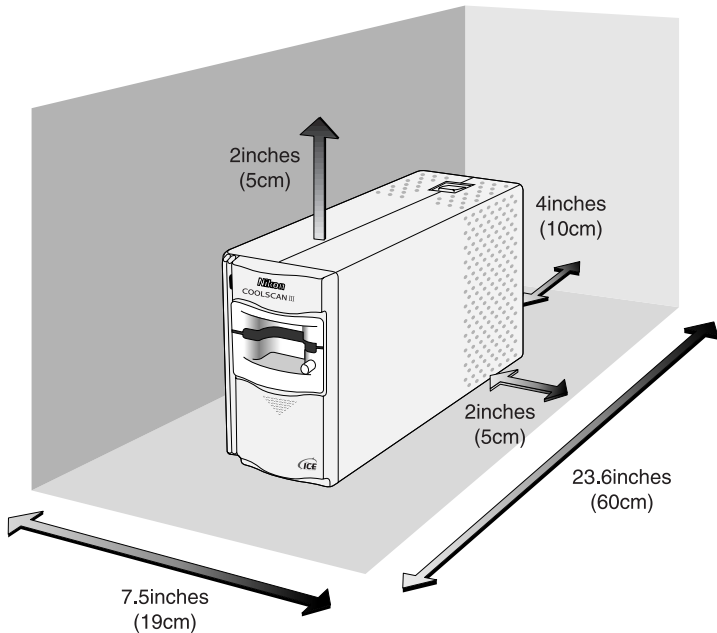

Step 2—Remove the transport locking screws

Once the scanner is installed, slide the front cover open. Using a coin, remove the transport locking screws from the adapter slot and side panel and screw them into the holes provided on the rear panel. The adapter slot contains a guard to prevent the transport screw from falling into the scan mechanism when the transport screw is removed. After removing the transport screw from the adapter slot and screwing it into one of the holes on the rear of the scanner, remove the guard and store it in a safe place.



Caution: *Never turn the scanner on with the locking screws in place. Turning the power on in these circumstances could damage the scanner.*

Note: *Replace the locking screws and guard when transporting the scanner (see the “LS-30 Reference Manual”).*

3. Setup

Step 3—Connect the power cable

Before connecting the power cable, confirm that the scanner is off and that the transport locking screws have been removed from the side of the scanner and adapter slot. The scanner is off when the end of the power switch marked “0” is down.

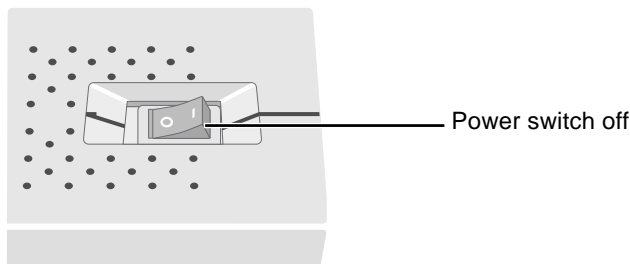

Attach the female end of the power cable to the AC connector on the rear of the scanner and insert the male end into a general-purpose household outlet.



Safety Precautions

- Use an AC power supply of 50/60Hz and a voltage of from 100V–240V. Be sure to use a power cord rated for the appropriate voltage.

At voltages of more than AC 125V:

use a power cord that complies with the safety standards of the country in which it is used, which has a plug rated for AC 250V, 15A (NEMA 6P-15) and insulation of SVT type or better, and which is more than AWG18 in thickness.

At voltages of AC 125V or less:

use a power cord that complies with the safety standards of the country in which it is used, which has a plug rated for AC 125V, 10A and insulation of SVT type or better, and which is more than AWG18 in thickness.

- Do not damage or modify the power cable. Fire or electric shock may result if the cable is placed under heavy objects, exposed to heat or flame, or forcibly tugged or bent.

3. Setup

- Should the insulation become damaged and the wires become exposed, contact your retailer or Nikon service office for replacement. Continued use could cause fire or electric shock.
- Do not handle the cable when your hands are wet. Doing so could cause electric shock.
- The outlet into which the power cable is plugged must be grounded. Failure to ground the power supply could result in electric shock.
- The scanner and all devices to which it is connected must be connected to a common ground. If a common ground is not used, a ground loop could occur, causing electric shock or static “noise.”
- Do not plug the power cord into an extension cord or multiple-outlet extension, as this could result in fire or malfunction.

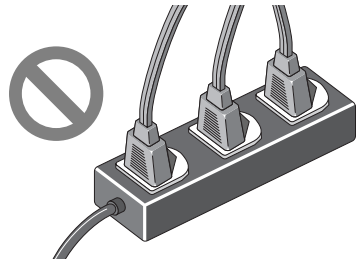

- Use an independent outlet whenever possible. If the scanner is plugged into an outlet to which a household appliance such as a vacuum cleaner or air-conditioner is connected, the scanner’s power supply may be subject to noise.
- Unplug the power cable by pulling on the plug, not on the cable itself. Pulling directly on the cord could result in damage that could cause fire or electric shock.

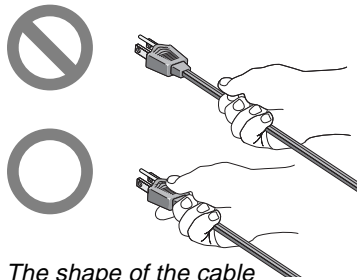

The shape of the cable depends on the country of sale

- Do not connect or disconnect the cable while the power is on.

3. Setup

Step 4—Connect the SCSI cable



The LS-30 connects to your computer by a Small Computer Systems Interface, or SCSI. To use a SCSI connection, you will need an appropriate SCSI cable and, in the case of IBM PC/AT compatible computers, a SCSI extension board (“SCSI adapter”) or PCMCIA card (see the *Fast Track Guide* and the *LS-30 Reference Manual* for details). This section describes the procedure to connecting the LS-30 to a SCSI “chain” made up of your computer and SCSI devices connected to it in a series.

SCSI devices cannot be connected while the power is on. Before connecting the scanner to the SCSI chain, be sure that the computer and all other devices in the chain, including the scanner, are off. How the scanner should be connected to the chain depends on whether it is to be located between other devices or attached at the end of the chain.

3. Setup

When the scanner is the last device in the chain

1. Set the terminator switch on the rear of the scanner to ON

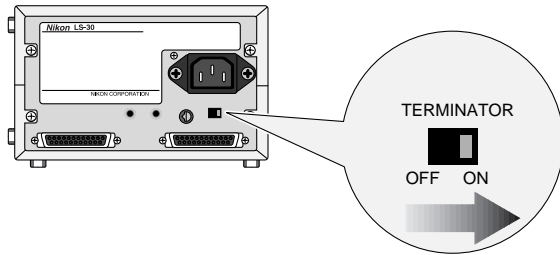

2. Connect the SCSI cable to either of the two SCSI connectors on the rear of the scanner and connect the other end to the next device in the chain

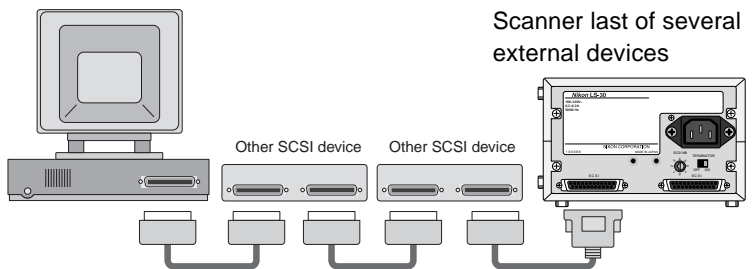
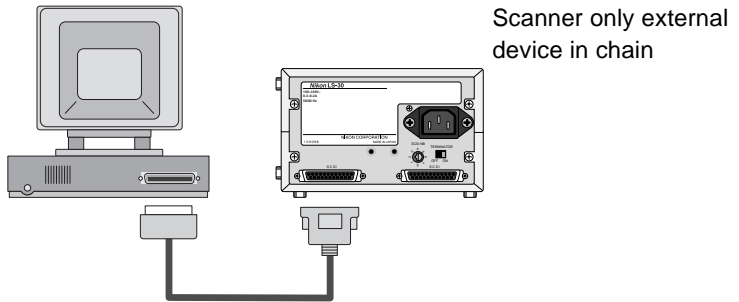

3. Setup

When the scanner is between other devices

1. Set the terminator switch on the rear of the scanner to OFF

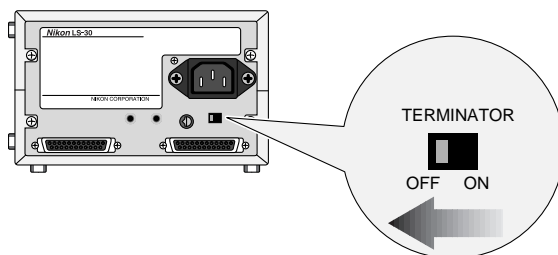

2. Connect the SCSI cable from one of the devices in the chain to either of the connectors on the rear of the scanner, then connect a cable to the remaining connector and attach the other end to a connector on the next device in the chain

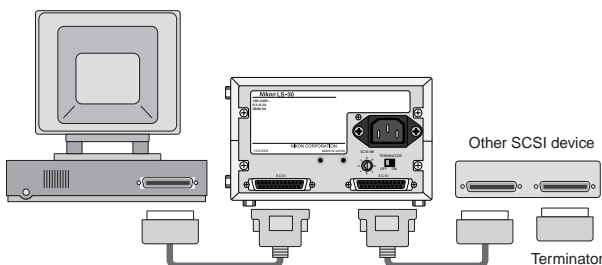

3. Confirm that the last device in the chain is terminated

Note: *If the last device in the chain has an unused SCSI connector, a separate terminator should be attached to it, even if the device is connected to the SCSI chain using a through terminator.*



SCSI connection checklist



- Turn off the computer, the LS-30, and all SCSI devices before connecting the scanner.
- Be sure that the devices at both ends of the SCSI chain are terminated. If the host computer is a Macintosh, the chain will already be terminated at the computer end. In the case of IBM PC/AT compatibles in a chain which contains external devices only, the chain should be terminated at the SCSI board. In the case of a chain which includes internal devices, you may need to remove termination from the board and terminate the last internal device.
- The maximum number of SCSI devices that can be connected in a single chain is eight, including the computer and any internal SCSI devices such as hard disks or CD-ROM drives.
- The total length of cabling in the SCSI chain should be no more than six meters (twenty feet). The longer the cabling, the less reliable the connection.



Safety Precautions

- Do not damage the SCSI cabling's protective insulation. Do not forcibly tug or bend SCSI cables, place cables under heavy objects or expose them to heat or flame. When disconnecting cables, handle the cable by the connector, not by the cable itself. Should the insulation be damaged or the internal wiring exposed, replace the cable immediately.
- Do not handle SCSI cables or devices when your hands are wet.

3. Setup

Step 5—Set the scanner's SCSI ID

Each device in the SCSI chain has a unique ID, which is a number between zero and seven that the computer uses to distinguish between different devices. When connecting the LS-30 to a SCSI chain, the scanner's SCSI ID must be set to a number that is not shared by any of the other devices, including the computer itself.

The scanner's SCSI ID is indicated by the SCSI ID dial on the rear panel. Before the scanner leaves the factory, the ID is set to "2."

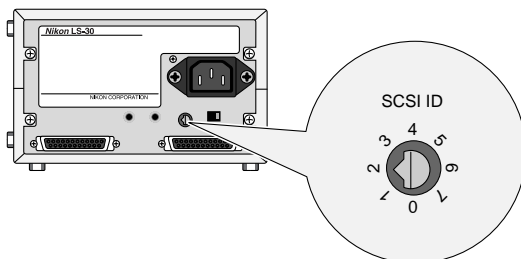

When choosing another ID for the scanner, bear in mind that the computer will usually have an ID of either "0" or "7," and that internal hard disks often have IDs of "0" or "1." In the case of Macintosh computers, the computer will have an ID of "7," while the internal hard disk and CD-ROM drive often have IDs of "0" and "3," respectively. In general, it is recommended that you set the scanner's ID to any number other than zero, one, three, and seven that is not used by another SCSI device.



Caution: *Assigning the same ID to two different devices could render the computer system inoperable or result in important data on a hard disk being lost or corrupted.*

3. Setup

To change the scanner's ID, turn the scanner off. Then, using a screwdriver, turn the dial on the back of the scanner to choose a new ID.

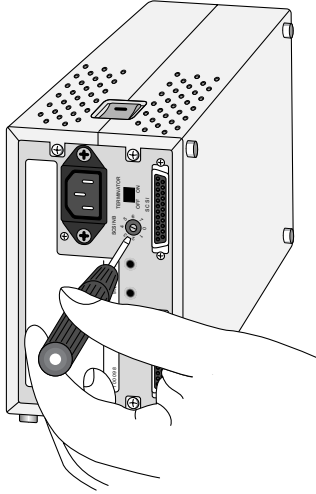

Note: *The LS-30 conforms to Level 1 of the SCAM (SCSI Configured Auto-Magically) SCSI-selection standard, which allows some computers to set the scanner's ID automatically. If your computer's operating system supports Plug&Play and the SCSI host (computer or SCSI extension board) conforms to SCAM, the scanner may be automatically assigned an ID which differs from that set using the SCSI ID dial. SCAM will not assign conflicting IDs to SCSI devices.*

3. Setup

3.2 Software Installation

This section describes how to install the Nikon Scan software that allows your computer to communicate with the LS-30. For reasons of space, detailed installation instructions are not provided in this user's guide. Details may be found in the reference guides provided separately on CD-ROM. Users who would like to review installation procedures should refer to these reference manuals, which can be read using the Adobe Acrobat software provided on the reference CD-ROM.

Step 1—Review the system requirements

To install and run Adobe Acrobat and Nikon Scan, your computer system must meet the requirements given below.

Macintosh

- Macintosh or Power Macintosh with a 68030 CPU or better
- MacOS System 7.1 or later
- ColorSync
- a minimum of 16 MB RAM available to Nikon Scan (24 MB or more is recommended) and 5 MB RAM available to Adobe Acrobat
- 28 MB or more free hard disk space (100 MB or more is recommended)
- video system supporting a color depth of at least sixteen bits, or 32,000 colors (a color depth of twenty-four bits, or 16.7 million colors, is recommended)

Windows

- IBM PC/AT or compatible with i486 or better CPU
- Windows 95, Windows NT4.0 or later
- a minimum of 16MB RAM when Nikon Scan is running (24 MB or more is recommended) and 8 MB RAM for Adobe Acrobat
- 28 MB or more free hard disk space (100 MB or more is recommended)
- DOS ASPI-compatible SCSI board with WINASPI.DLL (a list of boards that have been tested and approved by Nikon is provided separately)
- video system supporting a color depth of at least sixteen bits, or 32,000 colors (a color depth of twenty-four bits, or 16.7 million colors, is recommended)

Step 2—Install Adobe Acrobat Reader

Before turning on your scanner, you may wish to install Adobe Acrobat Reader and read the on-line documentation provided on the reference CD-ROM. To install Adobe Acrobat Reader, follow the installation instructions for your platform given below.

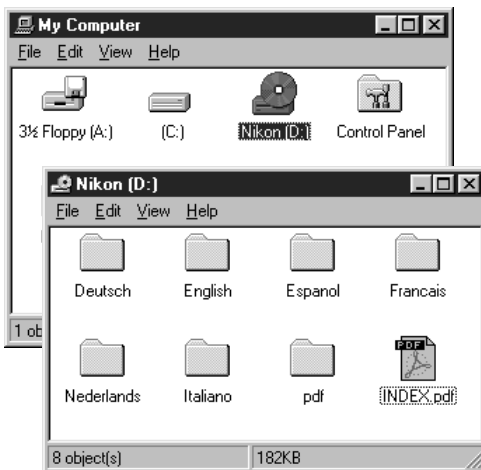

Windows

With the scanner turned off, turn on your computer and place the reference CD in the drive. Double-click the **My Computer** icon and then double-click the **Nikon CD** icon. Open the folder for the language of your choice and then double-click **setup.exe** to start the installer. Follow the on-screen directions to install Adobe Acrobat Reader in the location of your choice.

3. Setup

Macintosh

With the scanner turned off, turn on your computer and place the reference CD in the drive. The folder shown below will open on the desktop.

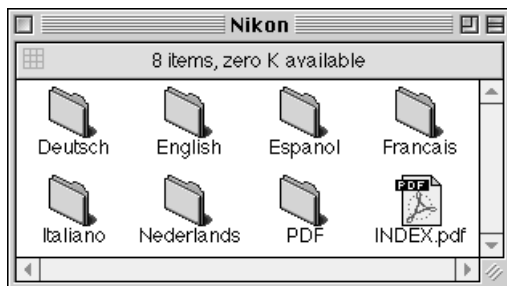

Open the folder for the language of your choice and double-click the installer icon. Follow the on-screen instructions to install Adobe Acrobat Reader in the location of your choice.

Once you have installed Adobe Acrobat Reader, you are ready to read the on-line documentation for the LS-30. To view the on-line reference manuals, double-click the **INDEX.pdf** icon in the root directory of the reference CD (see above). Before proceeding to the next step, you may wish to read *Before You Begin* in the *Nikon Scan Reference Manual* for your platform. After reviewing the reference manuals, turn off your computer and proceed to Step 3.



Step 3—Install Nikon Scan

Once the scanner has been installed and connected to your computer, you are ready to install Nikon Scan and begin scanning images. Before starting the installation process, turn on your scanner and any other peripherals, then turn on your computer.



Windows

At start-up, Windows will detect the LS-30 and display the dialog shown at left. Insert the Nikon Scan CD in the computer's CD-ROM drive, confirm that the **Driver from disk provided by hardware manufacturer** radio button is selected, and click **OK**. When the "Install from Disk" dialog appears, enter the drive letter of the CD-ROM drive in the **Copy manufacturer's files from** textbox and click **OK**. Windows will then register your scanner on the system.

Once the scanner has been registered, the Welcome dialog for the Nikon Scan installer will appear on the desktop (the Welcome dialog differs slightly depending on where your scanner was purchased; see the reference manual for details).

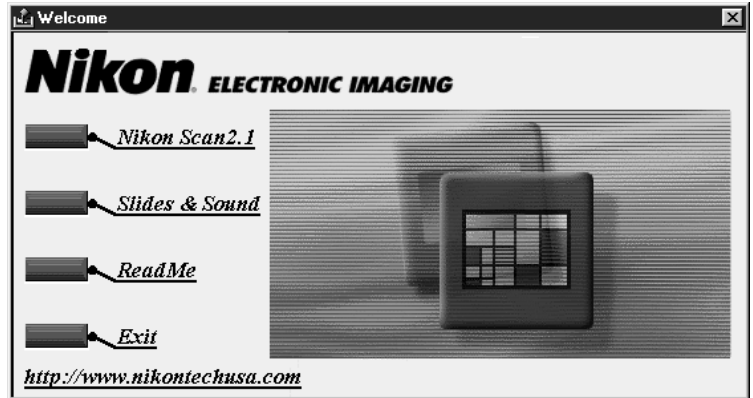

Click **Nikon Scan 2.1**. You will be prompted to choose a language for Nikon Scan's menus and dialogs. Installation can now be completed by following the instructions provided by the installer (see the *Nikon Scan for Windows Reference Manual* for details).



3. Setup

Macintosh

After turning on your computer, place the Nikon Scan CD in the CD-ROM drive. The folder shown below will open on the desktop.

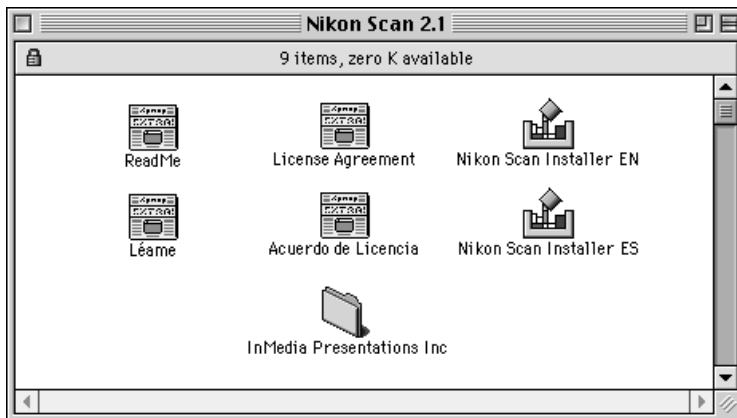

Double-click the installer for the desired language version of Nikon Scan (EN for English or ES for Spanish). Follow the instructions on the screen to complete installation. See the *Nikon Scan for Macintosh Reference Manual* for details.

4. Scanning

This chapter takes you step-by-step through the process using Nikon Scan to scan images with your LS-30.

Step 1—Turn on your computer

After turning on the scanner and any other peripheral devices, turn on your computer.

Step 2—Start Nikon Scan

Nikon Scan can be used to scan images into third-party host applications such as Adobe Photoshop, or it can be used as a “stand-alone” application for scanning images and saving them to disk. To start Nikon Scan from another application, select Nikon Scan from the application’s list of “acquire” or “import” sources. To use Nikon Scan as a “stand-alone” application, select Nikon Scan from the Start menu (Windows) or double-click the Nikon Scan icon in the folder to which Nikon Scan has been installed. Whether Nikon Scan is opened directly or from a host application, the Nikon Scan scan window will appear on the desktop after a brief pause while the program locates and identifies the scanner.



Nikon Scan
icon

The scan
window



4. Scanning



Step 3—Insert an adapter in the scanner

The LS-30 comes with separate adapters for scanning mounted 35 mm slides and strips of 35 mm film containing up to six frames each. Either adapter can be inserted in the scanner while the scanner is on. Before mounting an adapter in the adapter slot, check that the scanner's status LED is glowing steadily. Adapters should not be inserted or removed while the status LED is blinking. Open the scanner's front cover and slide the adapter in as shown in the illustrations below, stopping when the adapter is fully inserted. In the case of the SA-20, be sure that the connectors on the rear of the adapter are fully inserted in the connectors at the back of the adapter slot.

Inserting the
MA-20 SLIDE
MOUNT
ADAPTER

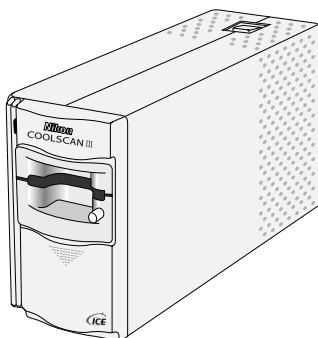
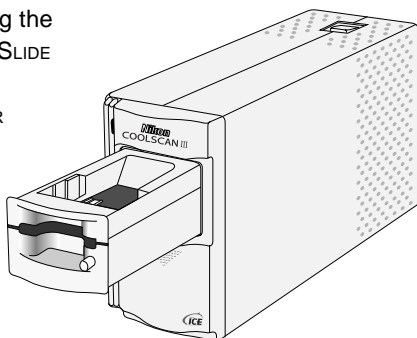

Inserting the SA-20 STRIP FILM ADAPTER



A plastic tray is provided with the strip-film adapter to catch film ejected from the scanner. This tray is attached to the adapter as shown below.

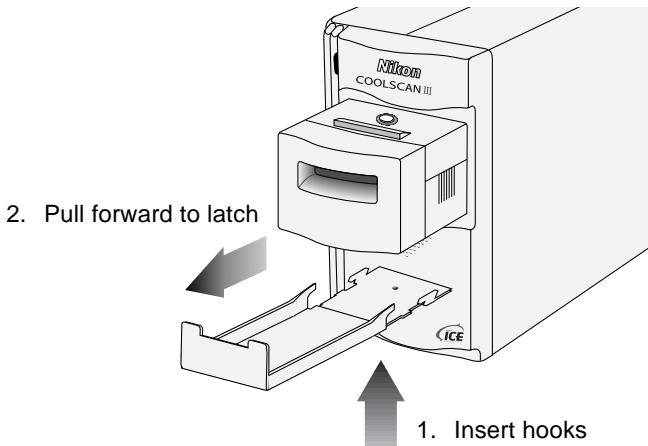

Cautions

- Wait until the status LED glows steadily or the scanner is off before inserting or removing adapters. Do not replace adapters while the scanner is operating.
- If an adapter does not slide in smoothly, remove it from the adapter slot and try again. Do not use force.

4. Scanning



Step 4—Insert film

Insert the film to be scanned into the adapter's film slot. When the scanner is installed on its side, the film should be oriented so that the photograph or frame number is not reversed. When inserting slides, the short side of the aperture should face toward the scanner.

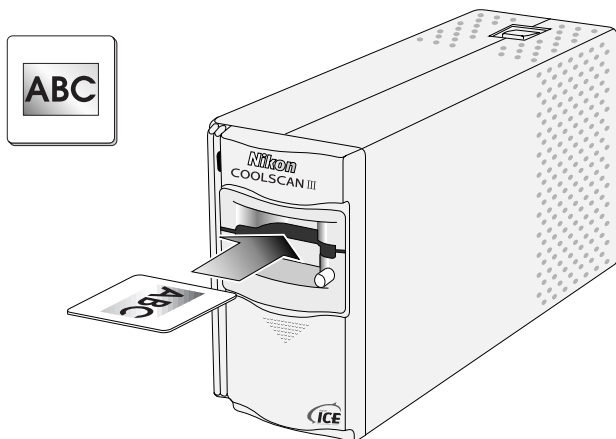

To scan a film strip with the SA-20 strip-film adapter, grasp the film lightly by both edges and slide it into the film slot a short distance. The adapter's feed mechanism will be activated and the film will be fed into the scanner automatically.

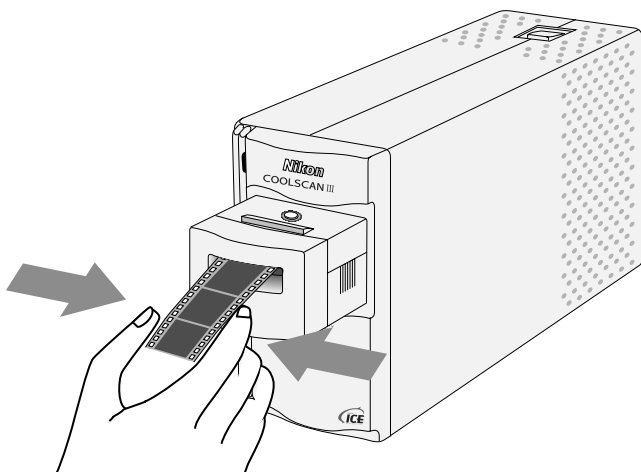



Cautions

- Examine the film for use in the SA-20 carefully prior to scanning. Film must be flat or curl slightly towards the emulsion surface (film should fit in the gauge on top of the adapter). Film cannot be used in the adapter if:
 - there is tape on the film
 - the film has been folded
 - the perforations have been torn
 - the film has been cut on an angle or torn



Film that cannot be scanned in the SA-20 can be scanned in the MA-20 slide adapter using the FH-2 film holder (see the *LS-30 Reference Manual*).

- Film must be clean and free from fingerprints. In the case of the SA-20, the presence of dirt could cause damage to the film. Before scanning, remove dust with a blower and gently wipe off any finger prints with a soft, dry cloth.



Detailed information on the kinds of film appropriate for use in the LS-30 and on inserting film, see the *LS-30 Reference Manual*.

Step 5—Choose a film type

In the scan window, select a film type appropriate to the type of film (positive or negative) inserted in the scanner.



Step 6—Choose a color space

Choose a color space from among those listed in the color-space pop-up menu. The color spaces available depend on whether Nikon Color Management is used; see the software reference manual for your platform for details.



By default, color spaces of calibrated RGB (sRGB), CMYK, and HSL are available.

4. Scanning

Step 7—Choose a thumbnail (SA-20)

If you are using the SA-20 strip-film adapter to scan film strips of two to six frames each, the thumbnail drawer-tab will be available. Click the drawer-tab to open the thumbnail drawer, then click the frame you wish to scan. Thumbnail previews of all images in the strip can be displayed by clicking the “display thumbnails” button.

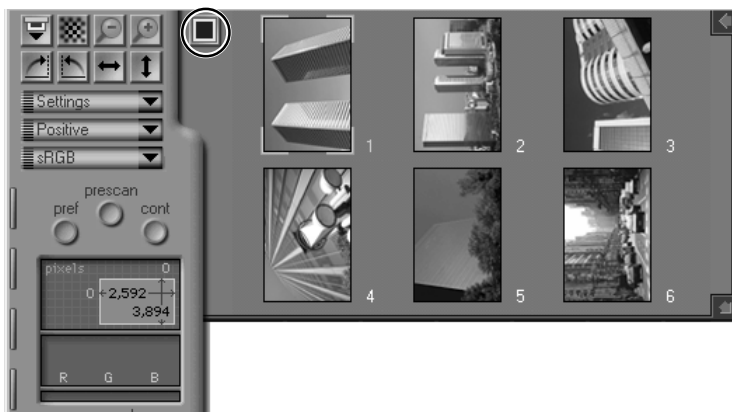
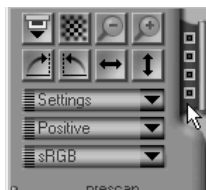

For more information on the thumbnail drawer, refer to the software reference manual for your platform.

Step 8—Perform a preview scan

The current slide or currently selected thumbnail can be previewed in the scan window, allowing you to choose the exact area for the final scan and to adjust exposure and color balance. To preview the current slide or the currently selected thumbnail, click the **preview** button. The scanner will perform a rapid preview scan, and a preview image will be displayed in the scan window.



Step 9—Select a crop

The area to be scanned when the image is passed to the host application is selected by dragging the mouse cursor over the preview image. The selected area will be indicated by a dotted line, or “marching ants” marquee.

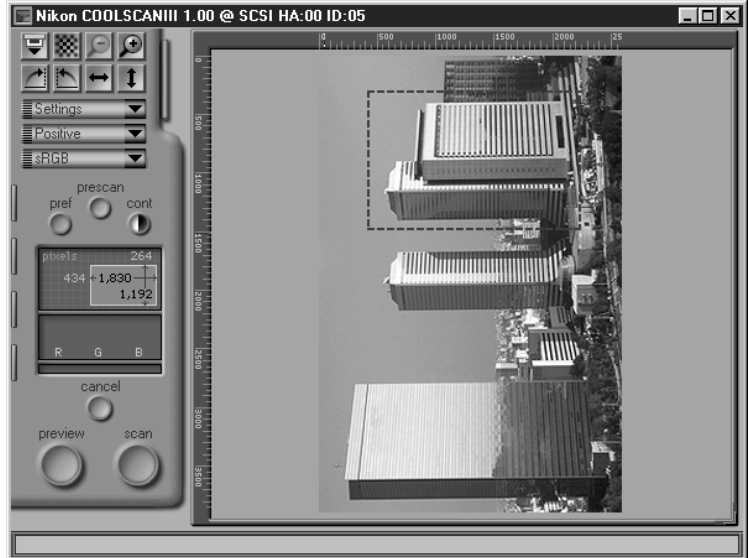

The crop can be zoomed in or out, flipped, or rotated using the buttons at the top left corner of the scan window. The crop can be shifted to a new part of the image by dragging, while the dimensions of the crop can be changed by dragging its borders. The size of the crop can also be adjusted using the crop size drawer, as described in the software reference manual for your platform.



Step 10—Auto contrast adjustment

Nikon Scan can automatically adjust image contrast to suit the color balance and tone range of the original. Click the **contrast** button to adjust contrast automatically.



4. Scanning

Step 11—Remove dust and scratches

Images can be treated digitally to remove dust and scratches. To do so, open the “scanner extras” drawer tab and select “Clean Image” from the options pop-up menu.

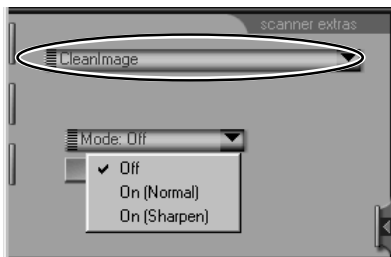

Select **On (Normal)** or **On (Sharpen)** from the **Mode** pop-up menu to automatically process the image to remove defects. The effects of Clean Image will be visible in the preview image in the scan window.



Consult the software reference manual for your platform for more information on the scanner extras available for the LS-30.

Step 12—Adjust color balance, contrast, and brightness

The controls in the color-balance drawer can be used to adjust RGB color balance, contrast, and brightness. Click the color-balance drawer-tab to open the color-balance drawer.

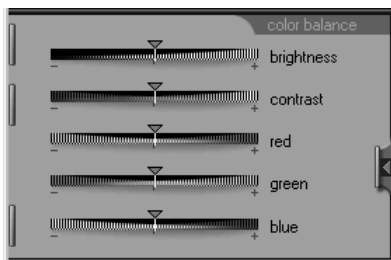
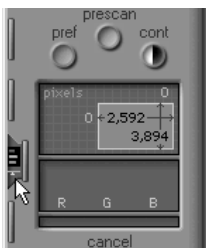

Adjust brightness, contrast, and color balance by dragging the sliders. The effects of these adjustments will be visible in the scan window.



More precise control of brightness, contrast, and color balance is available in the curves-and-levels drawer. Refer to the software reference manual for your platform.

Step 13—Scan the selected crop

Once you have selected a crop and adjusted scanner controls to your satisfaction, click the **scan** button. The selected crop will be scanned and transferred to the host application or to an image window in Nikon Scan. Depending on the application used or Nikon Scan Preference settings, the scan window may close when scanning is complete. For information on how to save and print scanned images using Nikon Scan, refer to the software reference manual for your platform.

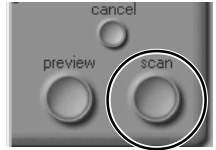

Step 14—Scan additional images

When Nikon Scan is being used as a “stand alone” application, the scan window can be activated after an image has been scanned by selecting the **Open Twain Source** command from Nikon Scan’s **File** menu (Windows) or by selecting the scanner from the **Device** submenu of the **Nikon Scan** menu (Macintosh). To re-open the scan window from another application, select Nikon Scan from the application’s list of “acquire” or “import” sources.



4. Scanning

Once the scan window has been re-opened, the current slide or film strip can be previewed and a new crop selected as outlined in steps 5 through 12, or the current film can be ejected and new film inserted and previewed. To eject a slide from the slide-mount adapter, press the eject button and then pull the slide the rest of the way out with your fingers.

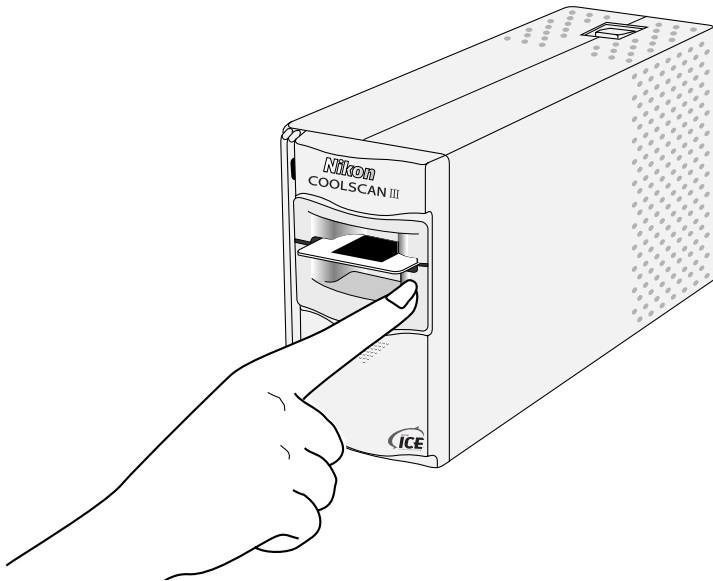

To eject film from the SA-20, click the eject button in the scan window.



Once the current film has been removed and the scanner's status LED is glowing steadily, new film can be inserted in the scanner and previewed as described in steps 4 through 12. If there is no film in the adapter and the scanner's status LED is glowing steadily, the current adapter can be removed and a new adapter inserted in the scanner as described in Step 3.

Appendix: Nikon Scan Controls

Menus, Tabs, and Information Displays

Thumbnail drawer-tab
Click to open when film is inserted in the SA-20 strip-film adapter or optional IA-20 IX240 film adapter

Settings menu
Save current settings, load saved settings, restore factory defaults

Film-type menu
Choose the type of film you want to scan

Color-space menu
Choose the color model (color space) used to display and store the image after scanning

Crop information display
The height and width of the current crop and the coordinates of its top left corner are displayed. Units can be chosen from the crop-size drawer (see below)

Pixel data display
The values for each color component are displayed when the cursor is moved over a pixel in the preview image

Progress indicator

Control drawer-tabs
Click to open, drag up or down to move (Windows). The contents of each drawer are shown below.

Appendix: Nikon Scan Controls

Buttons



Eject film from the SA-20 or optional IA-20 adapter



Focus the scanner on the center of the preview image. Clicking this button with the ctrl key (Windows) or option key (Macintosh) held down allows you to focus the scanner on a point chosen by clicking anywhere within the preview image.



Zoom out to the previous view after zooming in



Zoom in on the current crop



Rotate the preview image and/or currently selected thumbnails ninety degrees to the right



Rotate the preview image and/or currently selected thumbnails ninety degrees to the left



Flip the preview image and/or currently selected thumbnails horizontally



Flip the preview image and/or currently selected thumbnails vertically

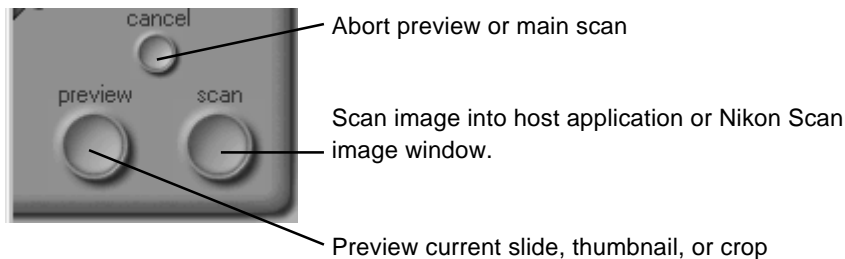
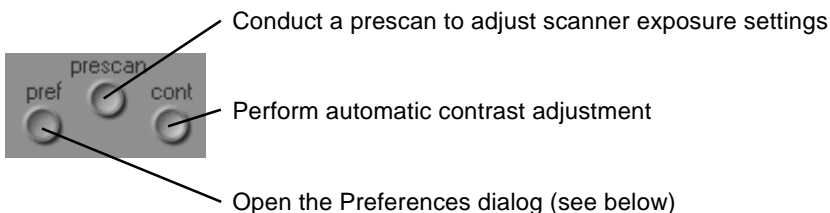

Control Drawers

The Scan-Size Drawer

Input units menu
The units used in giving the size of the current crop

- pixels
- inches
- centimeters
- millimeters
- picas
- points

Output units menu
The units used in giving the size of the image after scanning

- pixels
- inches
- centimeters
- millimeters
- picas
- points

Resolution units

- pixels/inch
- pixels/cm
- pixels/mm
- pixels/pica
- pixels/point

Device menu

- custom
- monitor
- Microsoft Fax

Input lock
Fix crop at its current dimensions

Scale
Amount crop will be scaled when scanned

Output lock
Fix size of final scan to current output dimensions and file size

Scan resolution
Output resolution (units can be chosen from pop-up menu). Resolution can be entered directly in text-box or chosen to match resolution of output devices in device pop-up menu.

The Scanner Extras Drawer

Scanner extras menu

Choose a scanner option from the menu to make adjustments to settings

Clean Image: Remove dust and scratches

Manual Focus Adjustment: Adjust scanner focus using a slider

Analog gain: Adjust brightness of scanner's light source

Scanner Extras: Adjust interpolation, sharpness, and prescan settings

Pixel Data Size: Set scan bit depth

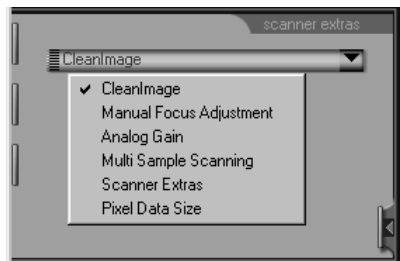

Module extras: Special settings for different adapters

Appendix: Nikon Scan Controls

The Curves-and-Levels Drawer

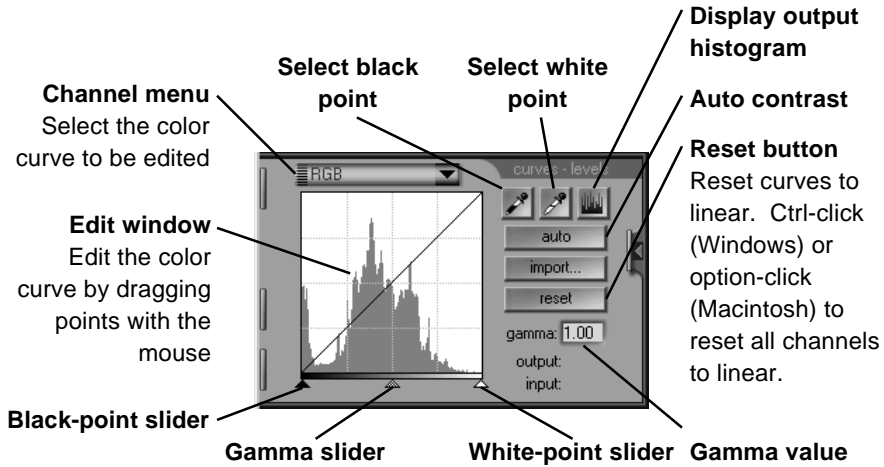

The Color-Balance Drawer

Adjust brightness, contrast, and color balance for the entire preview image by dragging the sliders

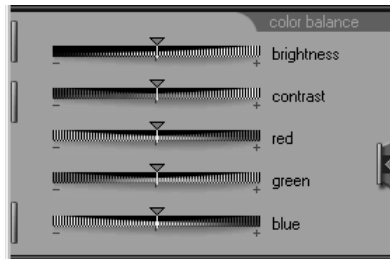

Preferences

The Preferences dialog contains several tabs, which are detailed in the software reference manual for your platform. A brief description of each tab is given below.

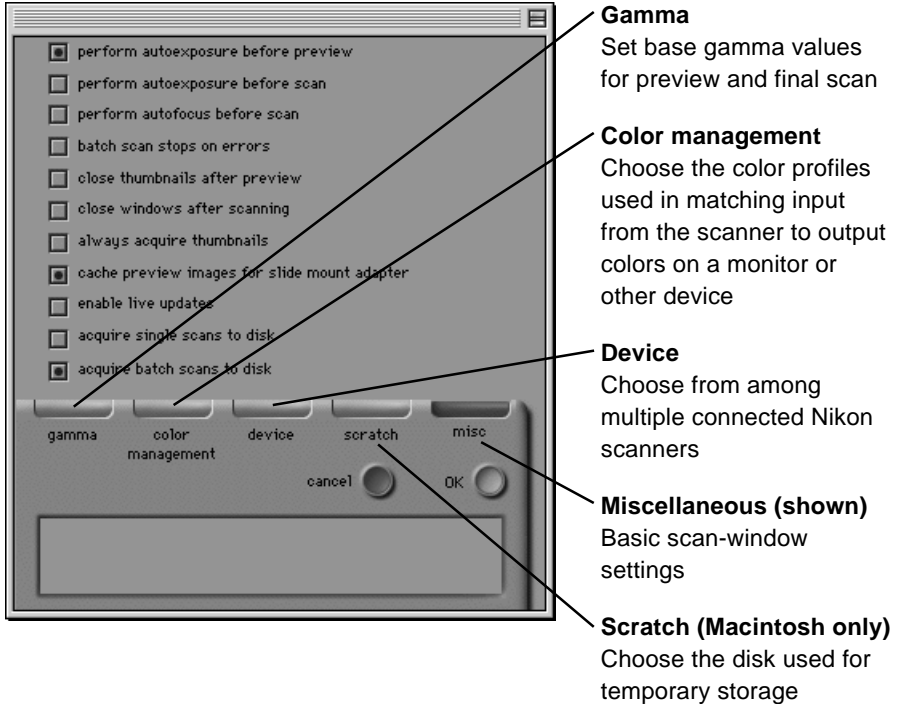

EC DECLARATION OF CONFORMITY

We

Name: Nikon Europe BV
Address: Schipholweg 321, 1171 PL Badhoevedorp, The Netherlands

declare that the product

Product Name: Nikon Film Scanner LS-30, SLIDE MOUNT ADAPTER MA-20 , STRIP FILM
ADAPTER SA-20

Manufacturer's Name: Nikon Corporation

Manufacturer's Address: Fuji Bldg., 2-3, Marunouchi 3-chome, Chiyoda-ku, Tokyo 100-8331, Japan

is in conformity with the following Standards

Safety: EN60950
EMC: EN55022 Class B
EN61000-3-2 1995
EN61000-3-3 1995
EN50082-1
IEC801-2: 1991 4kV (direct discharge), 8kV (air discharge)
IEC801-3: 1984 3V/m
IEC801-4: 1988 1kVAC, (0.5kV, I/O)

following the provisions of the EMC Directive (89/336/EEC)

DECLARATION DE CONFORMITÉ DE LA CEE

Nous

Nom: Nikon Europe BV
Adresse: Schipholweg 321, 1171 PL Badhoevedorp, The Netherlands

déclarons que ce produit

Nom du produit: Nikon Film Scanner LS-30, SLIDE MOUNT ADAPTER MA-20 , STRIP FILM
ADAPTER SA-20

Nom du fabricant: Nikon Corporation

Adresse du fabricant: Fuji Bldg., 2-3, Marunouchi 3-chome, Chiyoda-ku, Tokyo 100-8331, Japon

est conforme aux normes suivantes

Sécurité: EN60950
CEE: EN55022 Classe B
EN61000-3-2 1995
EN61000-3-3 1995
EN50082-1
IEC801-2: 1991 4kV (décharge par court-circuit), 8kV (décharge par amorçage)
IEC801-3: 1984 3V/m
IEC801-4: 1988 1kVAC, (0.5kV, I/O)

selon les dispositions de la directive de la CEE (89/336/EEC)

ERKLÄRUNG ÜBER EG-NORMENGERECHTHEIT

Wir

Name: Nikon Europe BV
Anschrift: Schipholweg 321, 1171 PL Badhoevedorp, The Netherlands

erklären hiermit, daß das folgende Produkt

Produktbezeichnung: Nikon Film Scanner LS-30, SLIDE MOUNT ADAPTER MA-20 , STRIP FILM
ADAPTER SA-20

Name des Herstellers: Nikon Corporation

Anschrift des Herstellers: Fuji Bldg., 2-3, Marunouchi 3-chome, Chiyoda-ku, Tokyo 100-8331, Japan

den nachstehend aufgeführten Normen genügt:

Sicherheit: EN60950
EMC: EN55022 Klasse B
EN61000-3-2 1995
EN61000-3-3 1995
EN50082-1
IEC801-2: 1991 4kV (Direkt Entladung), 8kV (Raum Entladung)
IEC801-3: 1984 3V/m
IEC801-4: 1988 1kVAC, (0.5kV, I/O)

und zwar gemäß den Bestimmungen der EMC-Richtlinie (89/336/EEC)

DECLARACIÓN DE CONFORMIDAD DE LA CEE

Nosotros

Nombre: Nikon Europe BV
Dirección: Schipholweg 321, 1171 PL Badhoevedorp, The Netherlands

declaramos que el producto

Nombre del producto: Nikon Film Scanner LS-30, SLIDE MOUNT ADAPTER MA-20 , STRIP FILM ADAPTER SA-20

Nombre del fabricante: Nikon Corporation

Dirección del fabricante: Fuji Bldg., 2-3, Marunouchi 3-chome, Chiyoda-ku, Tokyo 100-8331, Japón

cumple las normas siguientes

Seguridad: EN60950

EMC: EN55022 Clase B
EN61000-3-2 1995
EN61000-3-3 1995
EN50082-1

IEC801-2: 1991 4kV (descarga directa), 8kV (descarga ambiental)

IEC801-3: 1984 3V/m

IEC801-4: 1988 1kVAC, (0.5kV, I/O)

según las disposiciones de la Directiva EMC (89/336/EEC)



Badhoevedorp, The Netherlands

July 12th, 1998

Place	Date	Signature/Managing Director
Lieu	Date	Signature/Directeur général
Ort	Datum	Unterschrift/Geschäftsführer
Lugar	Fecha	Firma/Director general