

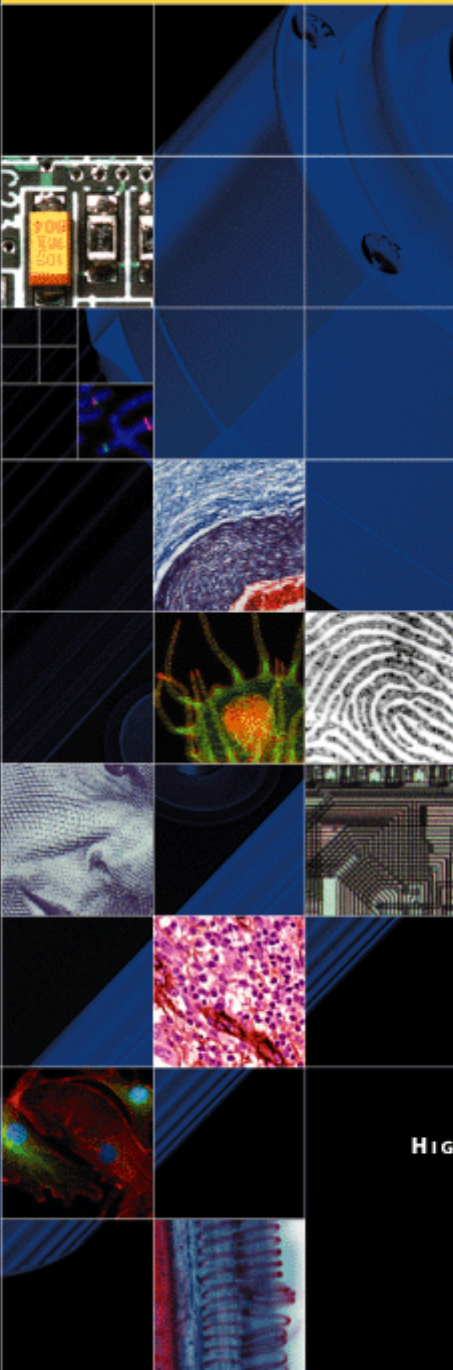

# User Manual

## QICAM

High Performance IEEE 1394 FireWire™ Digital CCD Camera - Monochrome or Color



HIGH PERFORMANCE DIGITAL IMAGING

**made easy**

---

# **QICAM 10-bit User's Manual**

## **Applicability**

This document applies to the QICAM 10-bit camera. For the latest updates, please visit [WWW.QIMAGING.COM](http://WWW.QIMAGING.COM).

## **Notice of Copyright**

Copyright© 2003 Quantitative Imaging Corporation. All rights reserved. Unauthorized duplication of this document is prohibited.

## **Trademarks and Proprietary Names**

QImaging, Retiga, and QCapture are trademarks of QImaging. Product names mentioned in this document may be trademarks or registered trademarks of QImaging or other hardware, software, or service providers and are used herein for identification purposes only. Microsoft™ and Windows® are registered trademarks in the U.S. and other countries of Microsoft Corporation and are used herein for identification purposes only. Apple™ and Macintosh® are registered in the U.S. and other countries by Apple Computer, Inc. and are used herein for identification purposes only.

## **QImaging Corporation Address Information**

4401 Still Creek Drive,  
Suite 100, Willingdon Business Park  
Burnaby, BC, Canada V5C 6G9  
604.708.5061

[WWW.QIMAGING.COM](http://WWW.QIMAGING.COM)

## **QImaging Technical Support**

Technical support is available to all registered users of QImaging products from 9am to 5pm Pacific Standard Time.

[SUPPORT@QIMAGING.COM](mailto:SUPPORT@QIMAGING.COM)  
604.708.5061

[WWW.QIMAGING.COM/SUPPORT/CONTACT/](http://WWW.QIMAGING.COM/SUPPORT/CONTACT/)

---

# CONTENTS

QICAM 10-bit User's Manual i

## INTRODUCTION 1

Power Requirements 1

Host Requirements 1

IEEE 1394 (Firewire) Interface 2

Cables 2

Imaging Software for Your Camera 2

## INSTALLATION 4

Step 1. Install the 1394 PCI card (Windows Users Only) 4

Step 2. Install Your Imaging Software 5

Step 3. Connect the QICAM 10-bit 5

## CAMERA BASICS 9

Turning the Camera On and Off 9

Connecting the QICAM 10-bit to your Optics 9

Understanding the LED Indicators 10

Capturing Images with the QICAM 10-bit 10

## ADVANCED CAMERA CONTROLS 11

Triggering the QICAM 10-bit Externally 11

Gain and Offset Controls 12

## CARING FOR YOUR CAMERA 13

## TROUBLESHOOTING 14

Resolving Problems with the camera 14

Unresolved Problems - Contacting QImaging Support 15

## GLOSSARY 16

## APPENDICES 18

APPENDIX A: External Trigger Port 18

## **INTRODUCTION**

The QImaging QICam CCD digital camera is designed for high resolution brightfield scientific and industrial applications. A progressive scan interline CCD sensor gives a resolution of 1.4 million pixels in a 10-bit digital output. High-speed low-noise electronics provide linear digital data for rapid image capture. The Firewire IEEE1394 digital interface allows ease of use and installation with a single wire requiring no framegrabber or external power supply. The QICam includes QCapture Software for Windows and Mac<sup>(R)</sup> based software systems for real time image preview and capture. A Software Development Kit (SDK) is available for interfacing with custom software.

## **Power Requirements**

The QICAM 10-bit can be powered through a single IEEE 1394 (Firewire) cable.

- **Power:**
  - Cooled QICAM 10-bit = 11 watts
  - Uncooled QICAM 10-bit = 6 watts
- **Input voltage range:** 8 - 24 volts

## **Host Requirements**

### **For Windows PCs:**

- Pentium® CPU, running at 300MHz.
- 256 MB RAM.
- Video card with 8 MB video memory capable of 32-bit color output.
- Microsoft Windows 98 Second Edition, Windows Millennium Edition (ME), Windows 2000, or Windows XP Professional.
- If the PC is not equipped with a Firewire card, the supplied card must be installed.

## **For Mac OS Computers:**

- PowerPC-based Macintosh with an OHCI compliant IEEE 1394 port (G4 and iMac® models).
- iMac models may not provide enough power to cooled cameras. QImaging's IEEE 1394 HUB may be required to power the camera. Contact QImaging for ordering information.
- Mac OS 9.1, 9.2 or X
- 256 MB+ RAM
- All the G4 and iMac models are equipped with a Firewire card. The supplied IEEE 1394 PCI is not required for Mac OS computers.

## **IEEE 1394 (Firewire) Interface**

The QICAM 10-bit is powered and controlled through an IEEE 1394 (Firewire) digital interface. A single Firewire connection from the camera to the computer allows full control of the camera and rapid image data transfer from the camera to the computer.

## **Cables**

A 10-foot Firewire interface cable is included with the camera. One end of this cable connects to either of the available Firewire ports at the back of the camera; the other end of the cable plugs into your computer's 6-pin Firewire port.

Some computers have 4-pin Firewire ports. These ports may be used if they are OHCI compliant, but you will need to purchase a 4-pin to 6-pin Firewire cable from your local computer store. If you connect the QICAM 10-bit to a 4-pin Firewire port, you likely need to use an external power supply.

## **What is the difference between 4-pin and 6-pin Firewire ports?**

Firewire cables are available in two varieties: 4-pin and 6-pin. 6-pin Firewire cables are capable of providing both power and a communication interface between the camera and computer while 4-pin cables provide only a communication interface. Some laptop computers have 6-pin Firewire jacks that do not provide power. If your computer has such a port, you will have to power your QICAM 10-bit by attaching an external power supply to the system.

## **Imaging Software for Your Camera**

### **Industry Standard Imaging Applications**

The QICAM 10-bit works with industry-standard Windows and Mac OS imaging software. Please go to the following URL for an up to date listing of third party software companies that support QImaging cameras. [HTTP://WWW.QIMAGING.COM/ALLIANCES/](http://www.qimaging.com/alliances/)

## **QCapture Suite Software**

The QICAM 10-bit operates on both Windows and Mac OS based systems. QCapture Suite Software for both systems is available at [www.QIMAGING.COM](http://www.QIMAGING.COM). The easy-to-use QCapture software gives you complete control over the camera's settings and image capture functions. QCapture Suite also includes a TWAIN-compliant interface that allows many Windows image-editing applications to acquire images using QImaging cameras.

---

# INSTALLATION

**IMPORTANT:** Follow these steps *in order* to complete the installation.

**DO NOT CONNECT** the camera until the camera driver is installed.

1. Windows PC users only: Install the IEEE 1394 PCI card - *only if necessary*.
2. Imaging Software - Install the software and drivers that your new QImaging camera needs to capture images.
3. QICAM 10-bit - Connect the camera to your computer using the supplied IEEE 1394 cable.

**DO NOT CONNECT** the camera until you have a functioning Firewire port in your computer and the camera driver is installed.

## Step 1. Install the 1394 PCI card (Windows Users Only)

This step is for Windows PC users only. If you are installing the QICAM 10-bit on a Mac OS computer, please skip to Step 2.

### Check your computer for an existing Firewire port:

The QICAM 10-bit connects to your Windows PC via a Firewire port. If you already have a Firewire port, you do not have to install the IEEE 1394 PCI card. Check the connectors at the back of your PC for a port that matches the Firewire ports on your camera (Figure 1 and Figure 2).

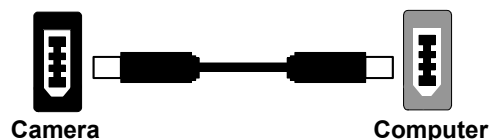

Figure 1— 6-pin to 6-pin Firewire (IEEE 1394) Port connection



Figure 2— 6-pin to 4-pin Firewire (IEEE 1394) Port connection

If your PC does not have a functioning Firewire port, you must install the IEEE 1394 PCI card that came with your camera.

If necessary, install the supplied IEEE 1394 PCI card:

- Shut down your computer.
- Open the case, and install the supplied IEEE 1394 card into an empty PCI slot. See the user's manual for your computer for complete instructions on installing new PCI cards.
- Restart your computer. Windows should automatically install the appropriate software drivers for the card.

## **Step 2. Install Your Imaging Software**

Once the IEEE 1394 card is installed in your computer, you are ready to install the Firewire drivers and imaging software. See your Imaging Software User's Guide for complete installation instructions.

## **Step 3. Connect the QICAM 10-bit**

Once your imaging software is installed, connect your camera. There are two different types of connections. In most cases, the Firewire cable provides the necessary power required by the QICAM 10-bit. However, if your camera is cooled you may need to provide additional power to the camera in one of the ways listed in the following figures. Most notably, you will need to either connect your camera with a 1394I power supply or through an IEEE 1394 HUB. Both items are available from your QImaging dealer.



## Connecting the camera to a PC/MAC desktop or MAC laptop Computer

Perform the following for connecting your camera.

- Remove the Firewire cable from the camera box, and plug one end of the cable into one of the camera's Firewire sockets (either socket is fine).

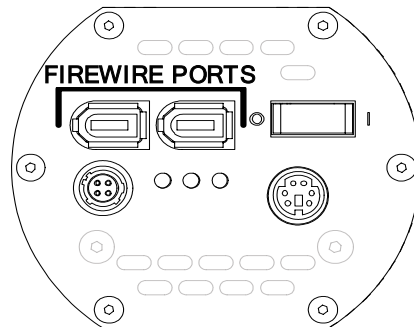

**Figure 3— Camera Firewire Sockets.**

- Plug the other end of the cable into a Firewire port on your computer

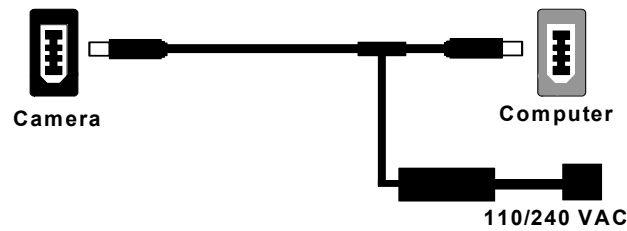

**Figure 4— Desktop Computer Firewire Connection**

There are some cases when connecting to a PC or Mac desktop or Mac laptop computer where not enough power is supplied through the IEEE 1394 cable. If this is the case, you may receive an Error

Code 28 or the software not working consistently. In this case, external power must be delivered to the camera which can be accomplished by connecting the camera via one of the following methods.

- Connection of an 1394 power supply with your camera is as follows:



**Figure 5— Firewire and 1394 Power Supply Connection**

- Connection of a 1394 IEEE HUB with your camera is as follows:

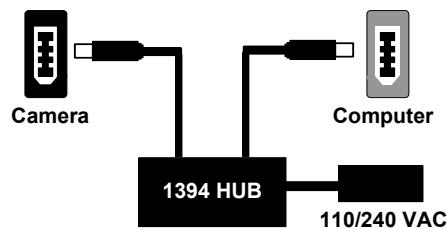

**Figure 6— Firewire and IEEE 1394 HUB Connection**

## Connecting the camera to a PC laptop computer

There are two common connection varieties for laptop computers;

- 1 Built-In Firewire port, or
- 2 PCMCIA Card.

### 1. Built-In 4-pin or 6-pin Firewire Port

There are cases with PC laptops where a built-in 6-pin FireWire port is available. If this is the case with your computer, it is possible that the two power pins on the Firewire port have been disabled, allowing only data communications. If you have such a connection or if you have a built-in 4-pin connector, you will need to power the camera.

If you purchased a 1394 power supply from QImaging, connect your camera as follows:

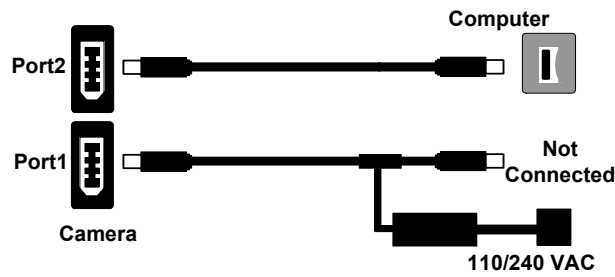

Figure 7— Firewire and 1394 Power Supply Connection

If you purchased an IEEE 1394 HUB, connect your camera as per the following figure.

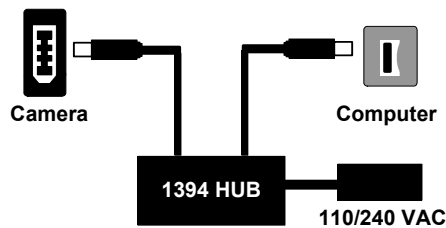

Figure 8— Firewire and IEEE 1394 HUB Connection

## 2. PCMCIA Card with a 4-pin/6-pin Firewire Port

In some cases, laptop computers have a firewire port from a PCMCIA card. Most of these PCMCIA cards allow an external connection directly to the card. If this is the case, and the PCMCIA connector is a 6-pin connector, then you should connect the power to your PCMCIA card and connect your camera as per Figure 9. However, if you have a 4-pin PCMCIA card Firewire port, then you will need to connect your camera in the configuration of either Figure 7 or Figure 8.

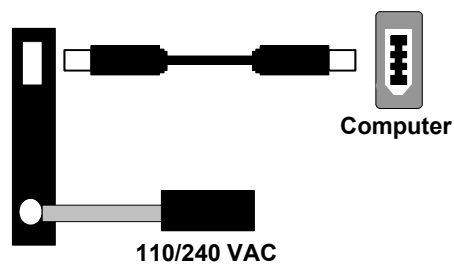

Figure 9— Firewire and 6-pin IEEE 1394 PCMCIA Connection

---

## CAMERA BASICS

The QICAM 10-bit's image capture capabilities are controlled entirely by your imaging software. This chapter provides basic instructions for working with the camera itself.

### Turning the Camera On and Off

To turn the QICAM 10-bit on, all you need to do is to flip the power switch to the “|” position ensuring that you have the appropriate configuration of “Step 3” in the “Introduction” section. Refer to this step for all system configurations ensuring that the FireWire cable(s) are connected as specified. If power is supplied, the GREEN LED will turn on.

To turn the QICAM 10-bit off, all you need to do is to flip the power switch to the “O” position. This will turn your camera off. The GREEN LED will turn off.

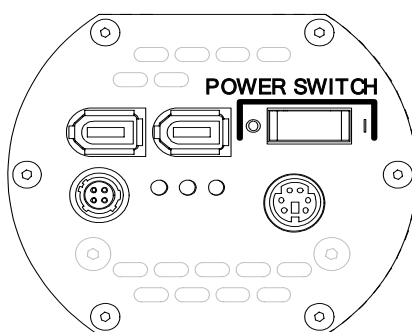

Figure 1— Power Switch on the QICAM 10-bit

### Connecting the QICAM 10-bit to your Optics

The QICAM 10-bit connects directly to widely available C-mount optics. C-mount optics, which are standard on most microscopes and lenses.

#### To attach the camera to a microscope:

Carefully thread the camera onto the microscope's C-mount adapter, rotating the camera until it is mounted securely. Use the microscope controls to adjust focus.

### **To attach a C-mount lens to the camera:**

Carefully thread the C-mount lens onto the camera's lens ring, rotating the lens in a clockwise direction until it is mounted securely. Use the lens controls to adjust focus.

### **To attach F-mount optics:**

If you have a monochrome camera and you have purchased the optional color filter, then carefully thread the color filter to the C-mount ring on the camera. The opposite end of the color filter is a female F-mount connector. Carefully connect your F-mount optics to the open connector of the color filter until it is mounted securely. Use your optics controls to adjust focus.

**NOTE:** If you did not purchase a color filter, then you will need to purchase a C to F mount adapter to allow the connection of F-mount optics. Your camera does not need to be monochrome in this situation.

## **Understanding the LED Indicators**

The LED indicators at the back of the camera give you important information about what your camera is doing:

- **GREEN:** The green LED is the power indicator. This LED should always be lit when the camera is connected to your computer and is turned on.
- **RED:** The red LED is the exposure/integration indicator. It flashes briefly when the CCD is exposing.
- **AMBER:** The amber LED is the cooling indicator. It illuminates only on cooled cameras - and only when cooling is turned on. If you turn off cooling (a setting in your imaging software), the amber LED will turn off too.

## **Capturing Images with the QICAM 10-bit**

Consult your imaging application's user's manual for more details.

---

## ADVANCED CAMERA CONTROLS

The QICAM 10-bit offers the user an advanced method of synchronizing to external events. The use of external triggering allows more advanced specialized applications of digital imaging. This section explains external triggering for the QICAM 10-bit as well as the operation and control of electrical gain and offset.

### Triggering the QICAM 10-bit Externally

Externally triggering the QICAM 10-bit provides a sophisticated method of imaging and synchronizing your camera to other parts of your system. To use this feature effectively, it is important to understand the operation and configuration of your camera.

The External Trigger Port of the QICAM 10-bit is a 6-pin miniature circular DIN connector. This port accepts digital logic signals that are used to control the camera's integration. The External Trigger Port is optically isolated from the camera's electronics. For this reason, the user must provide power to the External Trigger Port. See Appendix A for a pinout and schematic diagram of the External Trigger Port.

In externally triggered modes of operation, the user inputs a pulse on the External Trigger Port that controls the camera's integration in one of two ways depending on the triggering mode.

#### Triggering Modes

When using External Triggering, there are two different types of triggering modes: Edge High/Low and Pulse High/Low. The Edge mode allows the camera to start integrating on the rising or falling edge of the trigger pulse with the integration time controlled internally by the camera. Using this method allows you to externally trigger the camera as fast as possible, and allows you to take advantage of the simultaneous readout and exposure function.

Pulse Mode allows the user to control the integration period where the time is dictated by the duration of the pulse. If "Pulse High" mode is used, then the time the pulse is high is the time of the integration period. Vice versa for "Pulse Low" mode.

#### Connecting External Sources to the Camera

Before you can begin to externally trigger your camera, you need to connect the necessary trigger signal source to the camera. To do this you need to ensure that you have a 6-pin miniature circular din cable and ensure that the pinouts are set correctly from your trigger source. Refer to Appendix A for further details on pin assignments and a diagram of the mini-din connector.

There are several ways that you can provide an external pulse to the camera, one of them being via the QImaging External Trigger Board, which is available through QImaging, and another common device is a function generator. To trigger the camera, you need to provide a 5V TTL pulse through the pin stated in Appendix A.

To ensure that you will use the external triggering mechanism correctly, it is important to ensure that the following questions have been answered when devising or architecting your system design:

- Has a system design been developed that incorporates the necessary elements such as:
  - a Timing Diagram,
  - Flow of Events (e.g. a simple state diagram),
  - necessary components (e.g. microscope, flash lamp, shutter etc),
  - a software solution for extracting and/or processing your images,
  - External Triggering source (e.g. QImaging Trigger board, function generator etc)
- Have you Determined the type of triggering mode you require for you application.
- Are you sure the settings in the camera have been set correctly. For instance, are your monitoring the SYNCB output and if so have you set the correct output mode for your system?

The above list should be used as a guide and should be consulted before contacting QImaging Technical Support.

Trigger Mode	Trigger Source	Exposure Control
Continual	Intenal to Camera	Internal to Camera
Edge Hi/Lo	External Trigger Port	Internal to Camera
Pulse Hi/Lo	External Trigger Port	Length of User Pulse
Software	QCAM API Trigger Event	Internal to Camera

**Table 1—Trigger Sources and Integration Modes**

## Gain and Offset Controls

The QICAM 10-bit's electrical gain and offset controls allow the user to map an image's intensities of interest to the camera's digital range. This mapping is performed in the analog domain and thus avoids the quantization errors incurred when the mapping is performed in the digital domain.

Most users wish to operate the camera in a mode that maximizes dynamic range. The factory default electrical gain and offset are calibrated values that maximize the dynamic range. The electrical gain and offset can be controlled in software by the CCD Gain and Offset controls.

---

## CARING FOR YOUR CAMERA

The QICAM 10-bit camera requires no regular maintenance except occasional external cleaning of the CCD window (the glass window between the camera sensor and the microscope or lens).

### To clean the CCD window:

---

**CAUTION — The camera's CCD sensor, and circuits are sensitive to static discharge. Ensure you are using a static strap or are completely grounded at all times to release any static energy before you clean the CCD window.**

---

- Use clean forced air (available at stores that sell cameras and computer cleaning supplies) to dust the CCD window.

---

**CAUTION — Do not use acetone.**

---

- If the image still appears dirty, gently wipe the face of the CCD window with a small amount of optical grade isopropyl alcohol and lens paper.

Apply forced air again to remove any loose particles.



---

# TROUBLESHOOTING

## Resolving Problems with the camera

### The Green LED is not lit.

- Check all the cable connections.
- Flip the switch at the back of the camera.
- If your camera is still not lit, then your camera may not be receiving the required power. If you have a 1394 Power Supply or you have an IEEE 1394 HUB, connect the camera as listed in Step 3 of the “Introduction” Section.

### Image occasionally goes bright on one side or stays dark on one side

Turn off the overhead lights in the room. Fluorescent lights may interact with the camera to create fluctuating image brightness.

### Hazy image or poor contrast

- If you are using the camera on a microscope, check the magnification of the microscope coupler. Consult your microscope manufacturer to find the type of coupler that works optimally with the QICAM 10-bit camera’s sensor.
- Point the camera at something in the far distance. Loosen the set-screw of the C-mount ring (there are three: one on the side and two on the top). Adjust the C-mount ring until the image is in focus. Then tighten the set-screw so that the C-mount ring does not move.
- This effect may also be caused by excessive infrared (IR) illumination. Verify that your camera or optical system is blocking the IR. Contact QImaging to order an IR filter.

### Images That Do Not Appear “Sharp”

If the image does not seem “sharp,” check the format of the lens or the coupler being used on the microscope. QICAM 10-bit is equivalent to the CCD sensor and requires the appropriate lens or coupler. An incorrect coupler on the microscope will not provide the correct field of view, and will reduce the light available to the sensor.

## **Unresolved Problems - Contacting QImaging Support**

If you are still unable to resolve your problem, contact QImaging Support for assistance in one of four ways:

- Visit [HTTP://WWW.QIMAGING.COM/SUPPORT/FAQ/](http://www.qimaging.com/support/faq/) for a list of all frequently asked questions. Your issue may be resolved in one of these faqs.
- Visit [HTTP://WWW.QIMAGING.COM/SUPPORT/CONTACT/](http://www.qimaging.com/support/contact/) and fill out a support form online with the details of your problem.
- E-mail [SUPPORT@QIMAGING.COM](mailto:SUPPORT@QIMAGING.COM) with complete details of your problem (including Error Message and Code if possible), camera model, computer hardware configuration, and operating system.
- Call +1-604-708-5061. Try to be in front of your computer when you call.

---

# **GLOSSARY**

---

## **Binning**

Binning is a method of increasing camera speed and sensitivity to boost low signals. Binning causes the acquired image to be brighter and smaller, but the resolution will be lower as a result. Because the image is smaller, the image transfer time is reduced significantly.

When you select a binning setting in your imaging software, the camera combines data from several pixels in the camera's CCD into a single super pixel. For example, a 2x2 bin means that 2 pixels in the horizontal direction and 2 pixels in the vertical direction are combined to form one super pixel.

---

## **C-Mount**

A standard threaded lens mount used to attach a camera to a microscope, or a separate lens to a camera.

---

## **CCD**

Charge Coupled Device (abbr.)

---

## **CCD Gain**

The amount of analog signal amplification. The gain is factory-optimized for the camera's maximum dynamic range.

---

## **Charge Coupled Device**

The light sensitive silicon chip near the optical interface of the camera that converts light intensities into electrical signals. These are typically made up of many pixel elements whose intensities are interpreted by imaging software to display an image on the screen.

---

## **Dynamic Range**

The ratio of the saturation level of the CCD to the readout noise of the CCD camera system. Dynamic range is a measure of the ability of the camera to capture both bright and dark features in a single image. In general, the higher the camera's dynamic range, the more information per pixel it can capture.

---

## **Exposure**

The amount of time that light reaches the image sensor.

---

## **Field of View**

The area visible through the camera's optics.

---

## **Firewire**

---

See IEEE 1394.

---

## **IEEE 1394**

High bandwidth (40 megabytes/second - 1394a; 80 megabytes/second - 1394b) interface for connecting digital imaging, storage, and other devices to host computers.

---

## **Image Intensifier**

An electro-optical vacuum tube which intensifies or amplifies on low light level images.

---

## **Integration**

The active collection of photons as done by an image sensor.

---

## **Iris**

A diaphragm in the lens that opens or closes to set the aperture (the amount of light that passes through the lens to the CCD).

---

## **ms**

millisecond (abbr.); unit of measure for exposure time.

---

## **ns**

nanosecond (abbr.); unit of measure for exposure time.

---

## **Offset**

The offset value adjusts the CCD blacklevel relative to the analog-to-digital converter zero. It is factory-optimized for the camera's maximum dynamic range.

---

## **Pixel**

The smallest spatial element of a digital image.

---

## **s**

second (abbr.); unit of measure for exposure time.

---

## **us**

microsecond (abbr.); unit of measure for exposure time.

---

---

## APPENDICES

### APPENDIX A: External Trigger Port

The external trigger port at the rear of the camera is a 6-pin miniature circular DIN receptacle (AMP 749265-1). The mating connector is a Singatron Enterprises part number 62000-6P, available from Digikey ([www.digikey.com](http://www.digikey.com))

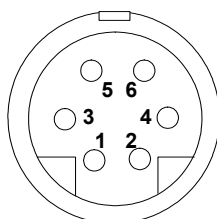

Figure 1— External Trigger Port Connector

The pinout for the connector is as follows

Pin Number	Signal Name	Signal Source	Description
1	+5 VDC	User	Power for Optocoupler trigger
2	Trigger (input)	User	Active Low Trigger Input
3	SYNC-A (output)	Camera	Indicates CCD Read-out
4	Ground	User	Ground Reference for Optocoupler
5	SYNC-B (output)	Camera	Exposure or Trigger Mask
6	Ground	User	Ground Reference for Optocoupler

Table 1—Pin-out of the External Trigger Port Connector

+5VDC (pin 1) and GROUND (pin 4 & pin 6) must be connected in order for SYNC-A, SYNC-B or TRIGGER to be live.

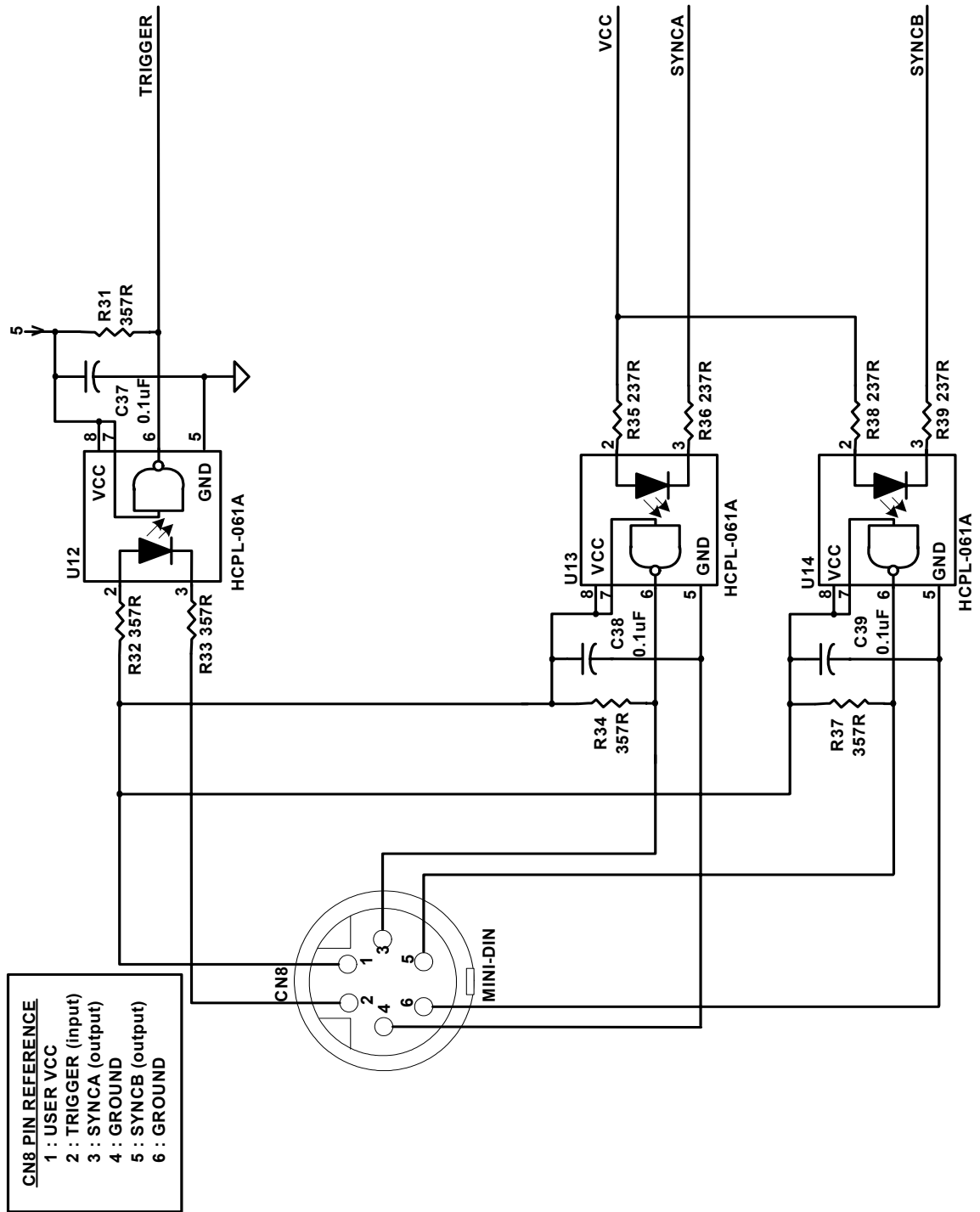

Figure 2— Schematic of External Trigger circuit internal to camera.

## Input Signals

In order to use the External Trigger Port correctly and ensure external triggering operation for your camera, you need to supply at least 4 input signals through the mini din receptacle. Pin 1 always needs to be powered at a 5V potential, with Pins 4 and 6 always connected to ground. The input signal to begin triggering the camera is through Pin 2 and should be a 5V TTL pulse.

## Output Signals

There are two output signals provided on the QICAM 10-bit, SYNC A and SYNC B.

**SYNC A:** This signal indicates the readout time of the camera and this signal is active high. A user could monitor this signal as a means of knowing when to trigger the next frame.

**SYNC B:** This signal has two modes of operation which can be selected in software. Refer to the QICAM SDK API documentation for further information on setting these parameters.

**Expose Mode:** If this mode is selected, the signal will indicate the exposure pulse of the camera. This signal is active high and may be used to synchronize an external shuttering device.

**Trigger Mask:** If this mode is selected, the signal will indicate the time at which another trigger signal will not be accepted by the camera. This signal is also active high.

## Signal Timing

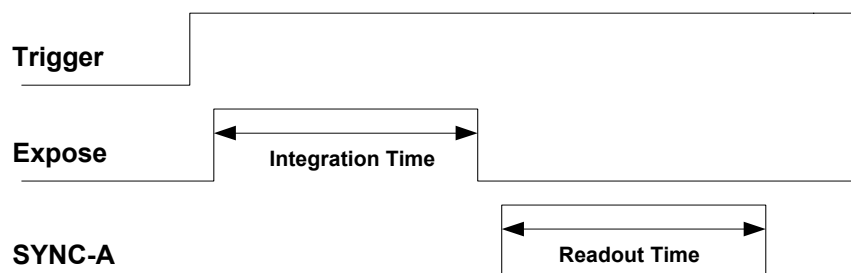

**Figure 3— External Trigger Signal Timing**

- The integration time corresponds to the length of time that the CCD has been programmed to be exposed to the image.
- The readout time corresponds to the time required to readout the CCD.