

# HANNING

by **HANN**spre

LCD Display

**HU282PPS(HSG1322)**

# **User's Manual**

Before operating the monitor, please read this manual thoroughly. This manual should be retained for future reference.



This device complies with requirement of EMC directive 2004/108/EC with regard to Electromagnetic Compatibility, and 2006/95/EC and 93/68/EEC with regard to Low Voltage directive.

**【Optional, depend on selected model】**

Socket-outlet shall be near the equipment and shall be accessible.

Trademark Notice:



Hanns.G products incorporate High-Definition Multimedia Interface (HDMI™) technology.

The terms HDMI and HDMI High-Definition Multimedia Interface, and the HDMI Logo are trademarks or registered trademarks of HDMI Licensing LLC in the United States and other countries.

## **RECYCLING INFORMATION**

We, at **HANNspree** care very much about our environment protection strategy and firmly believe that it helps us have healthier earth via appropriate treatment and recycling of industrial technology devices at the end-of-life.

These devices contain recyclable materials, which can be re-decomposed and re-integrated into brand-new marvels. On the contrary, other material can be classified to hazardous and poisoned substances. We strongly encourage you to contact the provided information to recycle this product.

For more information, please visit  
<http://www.hannspree.eu/>

## TABLE OF CONTENTS

<b>SAFETY NOTICE .....</b>	<b>5</b>
<b>PRECAUTIONS.....</b>	<b>5</b>
<b>SPECIAL NOTES ON LCD MONITORS .....</b>	<b>6</b>
<b>FEATURES.....</b>	<b>7</b>
<b>CHECKING THE CONTENTS OF THE PACKAGE .....</b>	<b>7</b>
<b>INSTALLATION INSTRUCTIONS .....</b>	<b>8</b>
<b>POWER.....</b>	<b>8</b>
<b>SETTING THE MONITOR ON THE WALL .....</b>	<b>9</b>
<b>MAKING CONNECTIONS.....</b>	<b>10</b>
<b>ADJUSTING THE VIEWING ANGLE.....</b>	<b>11</b>
<b>OPERATING INSTRUCTIONS .....</b>	<b>12</b>
<b>GENERAL INSTRUCTIONS.....</b>	<b>12</b>
<b>FRONT PANEL CONTROL .....</b>	<b>13</b>
<b>HOW TO ADJUST A SETTINGS .....</b>	<b>15</b>
<b>PLUG AND PLAY.....</b>	<b>18</b>
<b>TECHNICAL SUPPORT (FAQ) .....</b>	<b>19</b>
<b>Q &amp; A FOR GENERAL PROBLEMS .....</b>	<b>19</b>
<b>ERROR MESSAGE &amp; POSSIBLE SOLUTIONS .....</b>	<b>21</b>
<b>APPENDIX .....</b>	<b>23</b>
<b>SPECIFICATIONS.....</b>	<b>23</b>

## **SAFETY NOTICE**

1. The changes or modifications not expressly approved by the party responsible for compliance could void the user's authority to operate the equipment.
2. Shielded interface cables and AC power cord, if any, must be used in order to comply with the emission limits.
3. The manufacturer is not responsible for any radio or TV interference caused by unauthorized modification to this equipment. It is the responsibilities of the user to correct such interference.
4. Only use attachments/accesories specified by the manufacturer.

### **WARNING:**

To prevent fire or shock hazard, do not expose the monitor to rain or moisture. Dangerously high voltages are present inside the monitor. Do not open the cabinet. Refer servicing to qualified personnel only.

### **PRECAUTIONS**

- Do not use the monitor near water, e.g. near a bathtub, washbowl, kitchen sink, laundry tub, swimming pool or in a wet basement.
- Do not place the monitor on an unstable cart, stand, or table. If the monitor falls, it can injure a person and cause serious damage to the appliance. Use only a cart or stand recommended by the manufacturer or sold with the monitor. If you mount the monitor on a wall or shelf, use a mounting kit approved by the manufacturer and follow the kit instructions.
- Slots and openings in the back and bottom of the cabinet are provided for ventilation. To ensure reliable operation of the monitor and to protect it from overheating, be sure these openings are not blocked or covered. Do not place the monitor on a bed, sofa, rug, or similar surface. Do not place the monitor near or over a radiator or heat register. Do not place the monitor in a bookcase or cabinet unless proper ventilation is provided.
- The monitor should be operated only from the type of power source indicated on the label. If you are not sure of the type of power supplied to your home, consult your dealer or local power company.
- Unplug the unit during a lighting storm or when it will not be used for long period of time. This will protect the monitor from damage due to power surges.
- Do not overload power strips and extension cords. Overloading can result in fire or electric shock.
- Never push any object into the slot on the monitor cabinet. It could short circuit parts causing a fire or electric shock. Never spill liquids on the monitor.
- Do not attempt to service the monitor by yourself; opening or removing covers can expose you to dangerous voltages and other hazards. Please refer all servicing to qualified service personnel.
- The wall socket shall be installed near the equipment and shall be easily accessible.

## **SPECIAL NOTES ON LCD MONITORS**

The following symptoms are normal with LCD monitor and do not indicate a problem.

- Due to the nature of the fluorescent light, the screen may flicker during initial use. Turn off the Power Switch and then turn it on again to make sure the flicker disappears.
- You may find slightly uneven brightness on the screen depending on the desktop pattern you use.
- The LCD screen has effective pixels of 99.99% or more. It may include blemishes of 0.01% or less such as a missing pixel or a pixel lit all of the time.
- Due to the nature of the LCD screen, an afterimage of the previous screen may remain after switching the image, when the same image is displayed for hours. In this case, the screen is recovered slowly by changing the image or turning off the Power Switch for hours.
- If the screen suddenly flashes erratically or the backlighting fails, please contact your dealer or service center for repair. Do not attempt to repair the monitor yourself.

# BEFORE YOU OPERATE THE MONITOR

## FEATURES

- 71.1cm / 28" Wide Screen TFT Color LCD Monitor
- Crisp, Clear Display for Windows
- ERP
- GP Green Product
- Ergonomic Design
- Space Saving, Compact Case Design

## CHECKING THE CONTENTS OF THE PACKAGE

The product package should include the following items:

### LCD Monitor

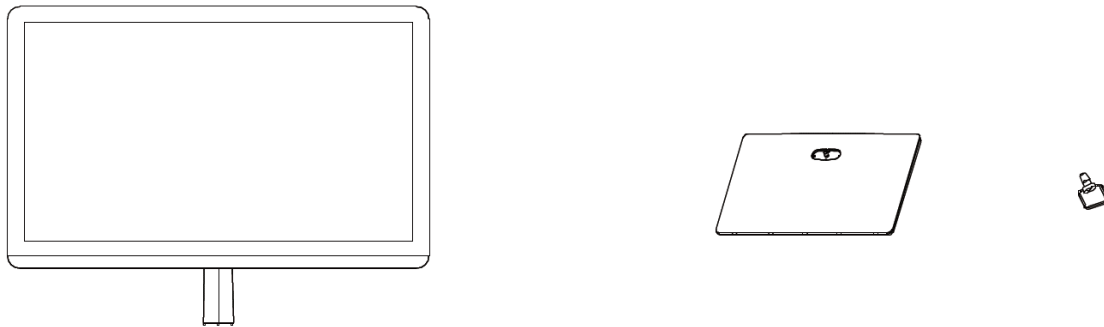

### Cables and User manual

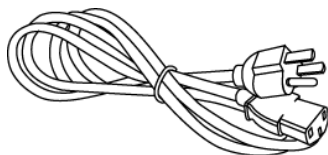

Power Cord



Warranty Card  
(optional)



Quick Start Guide

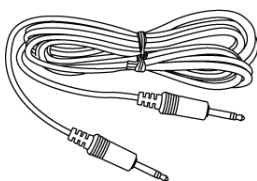

Audio Cable  
(optional)

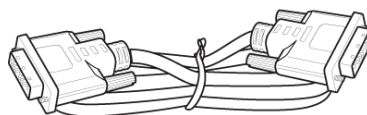

DVI Cable  
(optional)

## INSTALLATION INSTRUCTIONS

### INSTALL

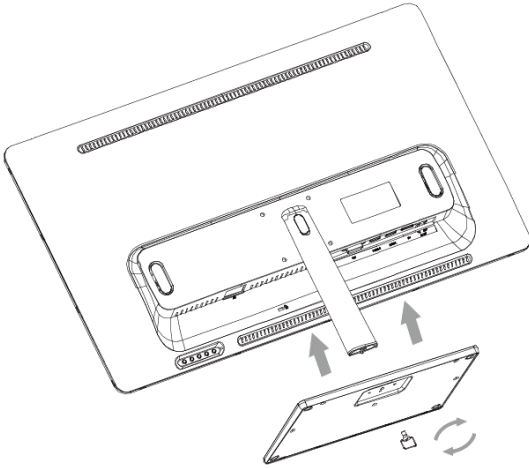

### REMOVE

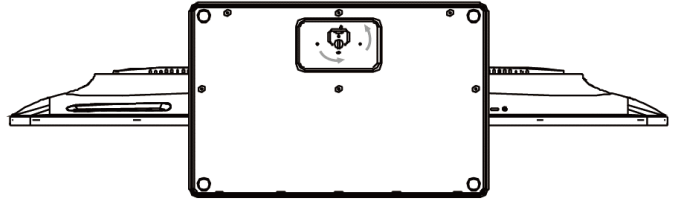

Figure.1. Installing and Removing the Base

### ***INSTALLATION:***

1. Align the monitor with the opening in the base.
2. Note that the longer section of the base points forward.
3. Snap the monitor into its base. Fasten the screw.
4. Verify that the monitor is securely attached to the base by looking at the bottom of the base and making sure that the clips are fully engaged in the base.

### ***REMOVAL:***

1. Flip over the monitor so that it is upside down.
2. Unscrew the screw that holds the monitor in place.
3. Gently pull the base from the monitor until they are unattached.

## POWER

### ***POWER SOURCE:***

1. Make sure that the power cord is the correct type required in your area.
2. This LCD monitor has an Internal universal power supply that allows operation in either 100/120V AC or 220/240V AC voltage area (No user adjustment is required.)
3. Connect the AC-power cord one end to your LCD monitor's AC-input socket, the other end to wall-outlet.



## SETTING THE MONITOR ON THE WALL DISSEMBLING THE STAND BASE:

1. Disconnect all the cables and cords from the Monitor to prevent breakage.
2. Carefully place the Monitor face down on a soft and flat surface (blanket, foam, cloth, etc) to prevent any damage to the Monitor.
3. Squeeze the sides to release the retaining plastic tabs and pull the stand cover off.
4. Remove the screws so that the stand base can be removed.
5. Gently remove the stand base.

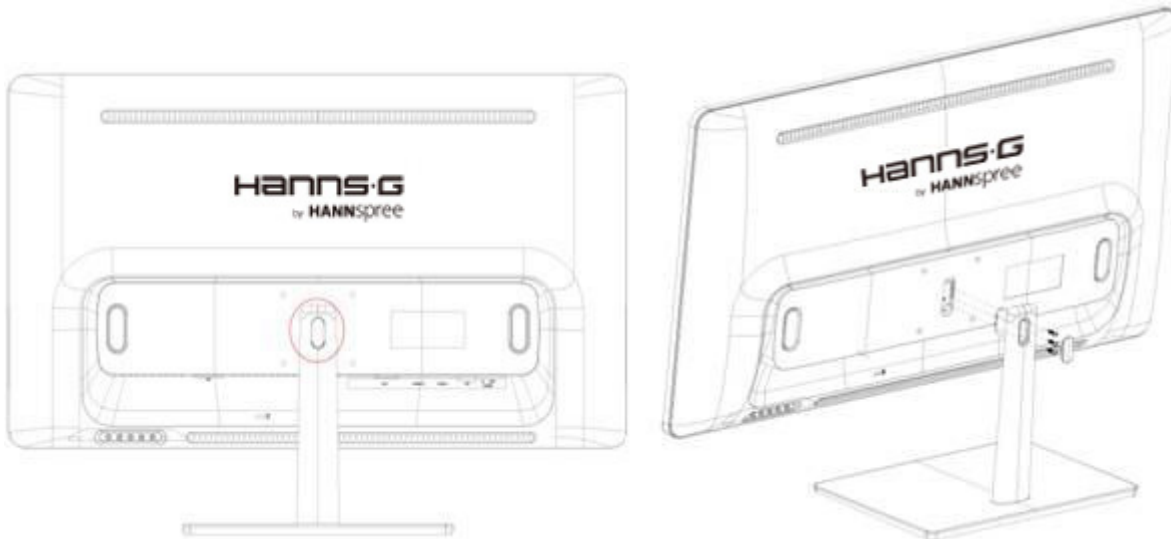

(For reference only)

## WALL MOUNTING THE MONITOR:

1. Purchase a VESA compatible wall bracket:  
VESA 75×75, 4 holes, M4, 7mm, 8kg.
2. Locate your ideal Monitor position on the wall.
3. Fix the wall bracket firmly on the wall.
4. Secure the Monitor to the bracket using the 4 mount holes on the back and center of the Monitor.

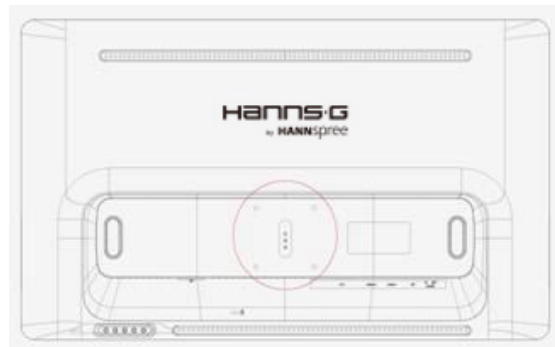

### Note:

- Please read the instructions of your specific wall bracket to properly wall mount the Monitor.
- The pitch of the mounting holes is 75mm horizontally and 75mm vertically.
- The screws type required is metric: M4, 7mm length.
- The Monitor stand base can be screwed on a table or a hard surface using the hole on the back of the stand base.
- For use only with UL listed wall mount bracket.

*\*Installing the LCD Monitor requires special skill that should only be performed by qualified service personnel. Customers should not attempt to do the work themselves. Hanns.G bears no responsibility for improper mounting or mounting that results in accident or injury. You can ask a qualified service personnel about using an optional bracket to mount the Monitor to the wall.*

## MAKING CONNECTIONS

### CONNECTING TO A PC

Turn off your computer before performing the procedure below.

1. Connect one end of the DVI cable (optional) to the back of the monitor and connect the other end to the computer's DVI port.
2. Connect one end of the HDMI cable (optional) to the back of the monitor and connect the other end to the computer's HDMI port.
3. Connect one end of the DP cable (optional) to the back of the monitor and connect the other end to the computer's DP port.
4. Connect the audio cable between the monitor's audio input and the PC's audio output (green port).
5. Plug one end of the AC power cord to the LCD monitor's AC input socket, and the other end to Wall outlet.
6. Turn on your monitor and computer.

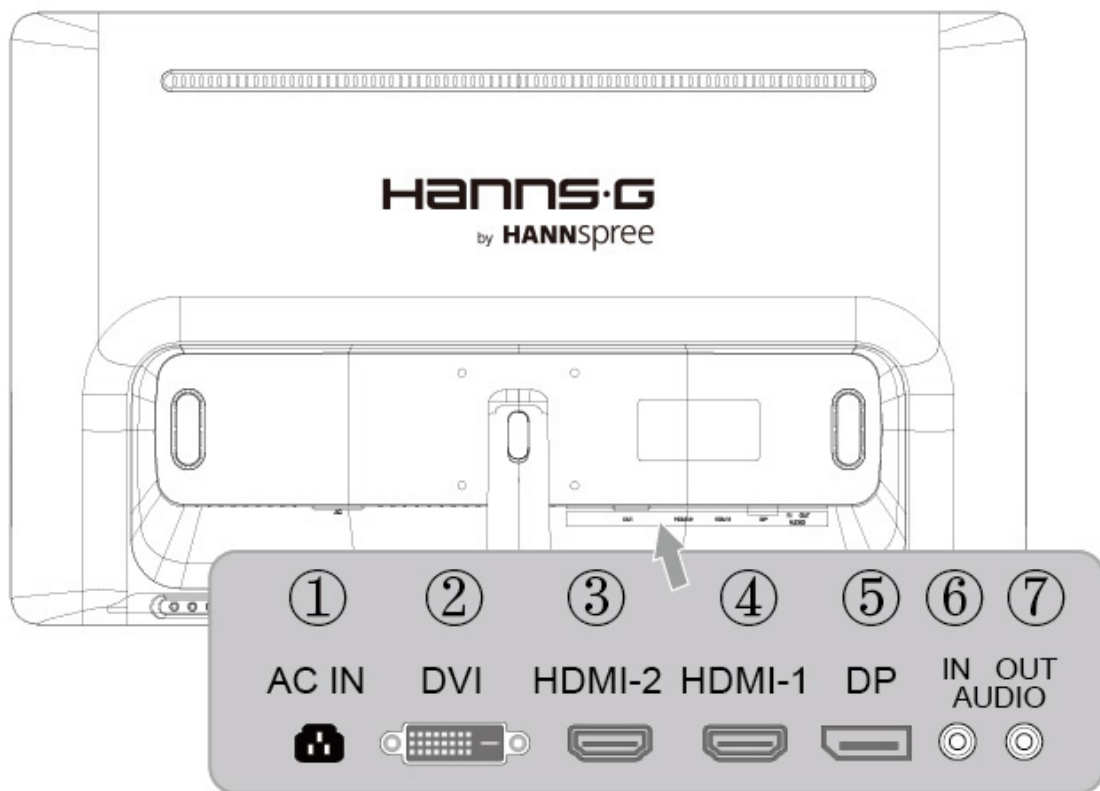

Figure.2. Connecting to a PC

1	AC IN	2	DVI
3	HDMI-2 (1.4)	4	HDMI-1 (4K)
5	DP Input	6	Audio IN Input
7	Audio out		

## ADJUSTING THE VIEWING ANGLE

- For optimal viewing it is recommended to look at the full face of the monitor, then adjust the monitor's angle to your own preference.
- Hold the stand so you do not topple the monitor when you change the monitor's angle.
- You are able to adjust the monitor's angle from  $-5^{\circ}$  to  $15^{\circ}$ .

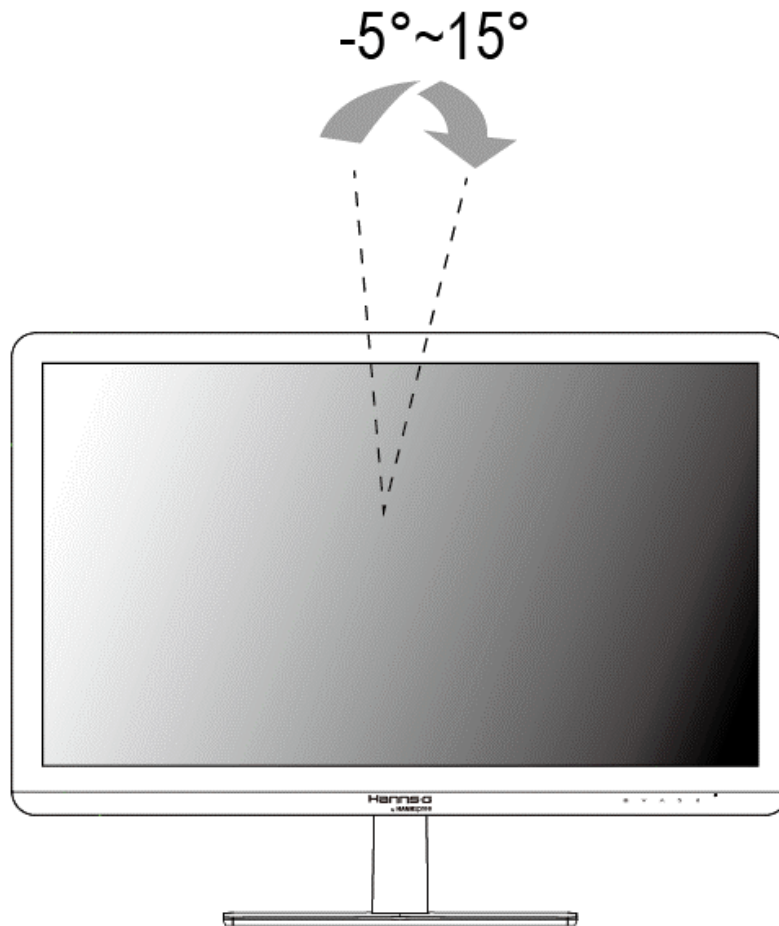

Figure.3. Monitor Angle

### **NOTES:**

- Do not touch the LCD screen when you change the angle. It may cause damage or break the LCD screen.
- Be careful not to place fingers or hands near the hinges when tilting the monitor, otherwise pinching can result.

# OPERATING INSTRUCTIONS

## GENERAL INSTRUCTIONS

Press the power button to turn the monitor on or off. The other control buttons are located on the front panel of the monitor (See Figure 4). By changing these settings, the picture can be adjusted to your personal preferences.

- The power cord should be connected.
- Connect the Signal cable from the monitor to the DVI card.
- Press the power button to turn on the monitor. The power indicator will light up.

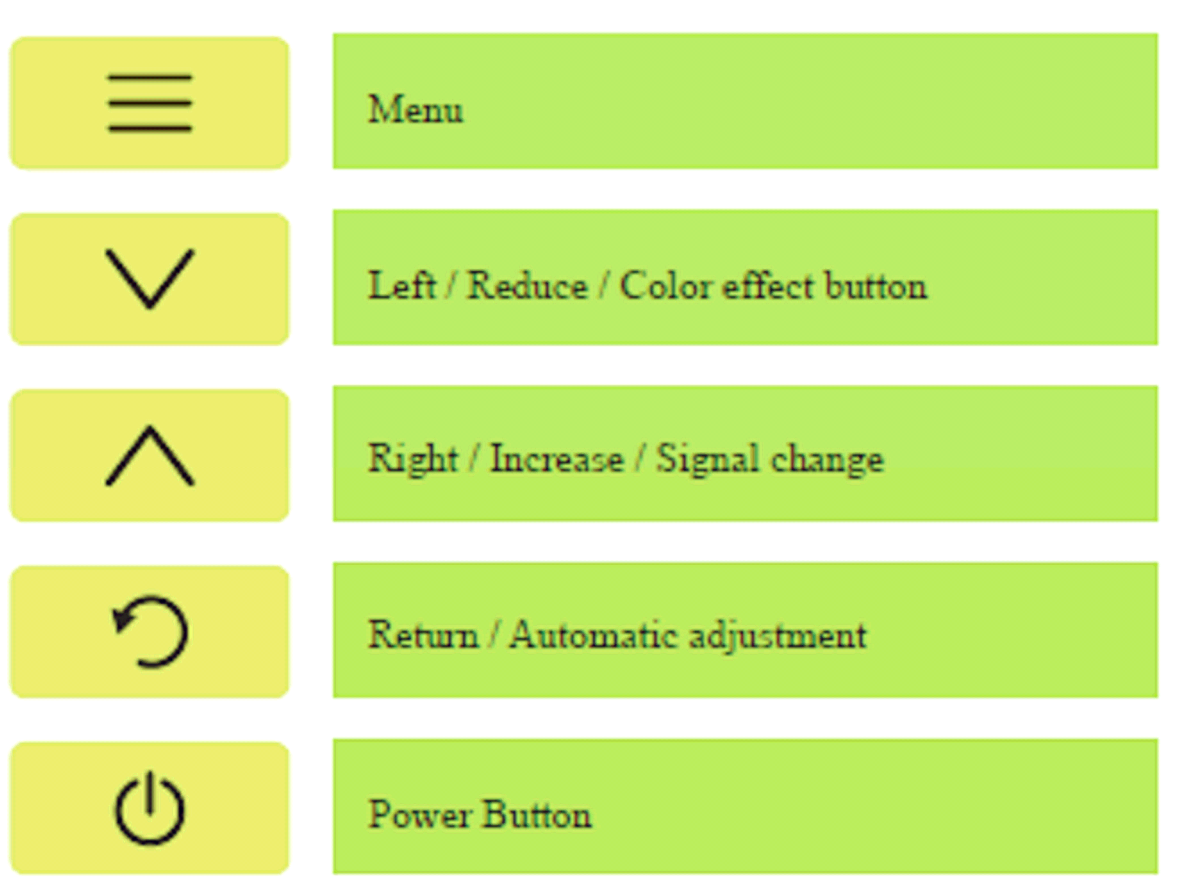

Figure.4. Control Panel Buttons

## FRONT PANEL CONTROL

- **【】 Power Button:**

Press this button to switch ON/OFF of monitor's power.

- **Power Indicator:**

Green — Power On mode.

Green flicker— Power Saving mode.

- **MENU:**

Turn the OSD menu on at the first time . then enter the sub menus at the second time .

- **Adjust  :**

1. Adjust full slider and number .

2. Navigate through adjustment icons when OSD is ON or adjust a function when function is activated.

- **【】 Button:**

EXIT main osd function .

- **Hotkeys:**

**1. COLOR EFFECT:**

Press **【】** key to change monitor color effect. Include standard model,game model,movic model,photo model , FPS1 model and FPS2 model.

[auto color function] press this button more than three seconds .(only analog input VGA model)

**2.INPUT SOURCE CHANGE:**

Press **【】** key to change monitor source.

**3.IMAGE AOTO ADJUSTMENT 《Only Analog Input VGA Model》**

Press **【】** Button will start 「Auto Adjust」 function .

**NOTES:**

- Do not install the monitor in a location near heat sources such as radiators or air ducts, or in a place subject to direct sunlight, or excessive dust or mechanical vibration or shock.
- Save the original shipping box and packing materials, as they will come in handy if you ever have to ship your monitor.
- For maximum protection, repackage your monitor as it was originally packed at the factory.
- To keep the monitor looking new, periodically clean it with a soft cloth. Stubborn stains may be removed with a cloth lightly dampened with a mild detergent solution. Never use strong solvents such as thinner, benzene, or abrasive cleaners, since these will damage the cabinet. As a safety precaution, always unplug the monitor before cleaning it.

## HOW TO ADJUST A SETTINGS

PICTURE	
BACKLIGHT	Adjust the brightness value of the display according to your preference. Select 「BACKLIGHT」 option to adjust the brightness value.
CONTRAST	Adjust the contrast value of the display according to your preference. Select 「CONTRAST」 option to adjust the contrast value.
BLACK EQUALIZE	Adjust the BLACK EQUALIZE value of the display according to your preference. Select「BLACK EQUALIZE」option to adjust the contrast value.
DISPLAY SETTING	
AUTO ADJUST	The auto adjustment function is used to optimize the 「H-POSITION」, 「V-POSITION」,「CLOCK」,and 「PHASE」. [For VGA Input only]
H POSITION	Select the 「H POSITION」option to shift the screen image to the left or right. Enter the option and adjust the level. [For VGA Input only]
V POSITION	Select the 「V POSITION」option to shift the screen image up or down. Enter the option and adjust the level. [For VGA Input only]
CLOCK	Select the 「CLOCK」 option to reduce the vertical flicker of characters on the screen. Enter the option and adjust the level. [For VGA Input only]
PHASE	Select the 「PHASE」 option to reduce the horizontal flicker of characters on the screen. Enter the option and adjust the level. [For VGA Input only]
SHARPNESS	Select the 「SHARPNESS」 option to adjust the sharpness of the display. Set the value from 0 to 4
COLOR SETTING	
TEMPERATURE	Adjust the color temperature value of the display according to your preference: SRGB, User ,9300,6500 ,5800.

USER	<p>Move the cursor to the User option and select it,</p> <ol style="list-style-type: none"> <li>1. To adjust the red, enter the 「 RED 」 option and adjust the level.</li> <li>2. To adjust the green, enter the 「 GREEN 」 option and adjust the level.</li> <li>3. To adjust the blue, enter the 「 BLUE 」 option and adjust the level.</li> </ol>
COLOR EFFECT	Adjust the color effect value of the display according to your preference: standard ,Game , Movie ,Photos ,FPS, RTS
GAMMA	Adjust the Gamma value of the display according to your preference: Off, 1.8 ,2.0 ,2.2,2.4
HUE	Adjust the Hue value of the display according to your preference. Select 「 Hue 」 option to adjust the contrast value.
SATURATION	Adjust the Saturation value of the display according to your preference. Select「 Saturation 」option to adjust the contrast value.
LOW BLUE LIGHT	Adjust the Low Blue light value of the display according to your preference: Off, ON
<b>ADVANCE SETTING</b>	
DP OPTION	Select the「 DP OPTION 」option to switch the function 1.2 or 1.1.
DDCCI	Select the 「 DDCCI 」 option to switch the function on or off
ULTRA VIVID	Adjust the Ultra Vivid value of the display according to your preference: OFF , L ,M ,H
ASPECT RATIO	Adjust the Aspect Ratio value of the display according to your preference: Full, 16:9 ,4:3, 5:4,1:1
DP EDID	Adjust the DP EDID value of the display according to your preference: 4K2K@60Hz, 1080P, 2560x1440, 4K2K@30Hz
OD	Select the 「 OD 」 option to switch the function on or off
<b>INPUT SETTING</b>	
INPUT SETTING	Select the 「 INPUT SETTING 」 option to change among DVI, HDMI1,HDMI2,DP source.



AUDIO SETTING	
VOLUME	Select the 「VOLUME」 option to change the volume level. Enter the option and adjust the level. [This function applies only to models with incorporated audio.] ● By high volume, risk of hearing damage exists.
MUTE	Select the 「MUTE」 option to switch the function On or Off. [The availability of this function depends upon the selected model. Adjusting the volume while muted cancels Mute mode.]
AUDIO SOURCE	Adjust the Audio Source value of the display according to your preference: Auto ,Analog , Digital .
OTHER SETTING	
LANGUAGE	Select 「LANGUAGE」 option to change the language of the OSD. Enter the option and select a language.
OSD H POSITION	Select 「H POSITION」 option to adjust the horizontal position of the OSD. Enter the option and adjust the level.
OSD V POSITION	Select 「OSD V POSITION」 option to adjust the vertical position of the OSD. Enter the option and adjust the level.
MENU TIME	Select the 「MENU TIME」 option to adjust the sharpness of the display. Set the value from 10 to 60
TRANSPRANCY	Select 「TRANSPARENCY」 option to adjust the transparency of the OSD. Enter the option and adjust the level.
RESET	Select the 「FACTORY RESET」 option to reset to the monitor's default setting. This will erase the current settings. Enter the option and select On or Off.
INFORMATION	Display Input Setting /Vertical frequency/Resolution information.

## **PLUG AND PLAY**

### **Plug & Play DDC2B Feature**

This monitor is equipped with VESA DDC2B capabilities according to the VESA DDC STANDARD. It allows the monitor to inform the host system of its identity and, depending on the level of DDC used, communicate additional information about its display capabilities. The DDC2B is a bidirectional data channel based on the I<sup>2</sup>C protocol. The host can request EDID information over the DDC2B channel.

**THIS MONITOR WILL APPEAR TO BE NON-FUNCTIONAL IF THERE IS NO VIDEO INPUT SIGNAL. IN ORDER FOR THIS MONITOR TO OPERATE PROPERLY, THERE MUST BE A VIDEO INPUT SIGNAL.**

## TECHNICAL SUPPORT (FAQ)

### Q & A FOR GENERAL PROBLEMS

PROBLEM & QUESTION	POSSIBLE SOLUTION
Power LED is not on	<ul style="list-style-type: none"> <li>*Check if the Power Switch is in the ON position.</li> <li>*Power Cord should be connected.</li> </ul>
No Plug & Play	<ul style="list-style-type: none"> <li>*Check if the PC system is Plug &amp; Play compatible.</li> <li>*Check if the Video Card is Plug &amp; Play compatible.</li> <li>*Check if any plug pins on the DVI or HDMI or DP connector are bent.</li> </ul>
The display is too dark or too bright.	<ul style="list-style-type: none"> <li>*Adjust the Contrast and Brightness Controls.</li> </ul>
Picture bounces or a wave pattern is present in the picture	<ul style="list-style-type: none"> <li>*Move electrical devices that may cause electrical interference.</li> </ul>
The power LED is ON (green) but there's no video or no picture.	<ul style="list-style-type: none"> <li>*Computer Power Switch should be in the ON position.</li> <li>*Computer Video Card should be snugly seated in its slot.</li> <li>*Make sure monitor's video cable is properly connected to the computer.</li> <li>*Inspect monitor's video cable and make sure none of the pins are bent.</li> <li>*Make sure computer is operational by hitting the CAPS LOCK key on the keyboard while observing the CAPS LOCK LED. The LED should either turn ON or OFF after hitting the CAPS LOCK key.</li> </ul>
Missing one of the primary colors (RED, GREEN, or BLUE)	<ul style="list-style-type: none"> <li>*Inspect the monitor's video cable and make sure that none of the pins are bent.</li> </ul>
Screen image is not centered or sized properly.	<ul style="list-style-type: none"> <li>* Adjust pixel frequency CLOCK and PHASE or press hot-key ().</li> </ul>
Picture has color defects (White does not look white)	<ul style="list-style-type: none"> <li>*Adjust RGB color or select color temperature.</li> </ul>
The screen resolution needs to be adjusted	<ul style="list-style-type: none"> <li>*Use win 2000/ME/XP Right click anywhere on desktop and select <b>Properties&gt;Settings&gt;Screen Resolution</b>. Use the silder to adjust the reslution and click <b>Apply</b>.</li> </ul>
No sound is outputted from monitor's built-in speaker	<ul style="list-style-type: none"> <li>*Make sure PC audio output cable is connected to screen's LINE IN port (or AUDIO IN port).</li> <li>*Make sure the sound volume adjustment can be clearly identified.</li> <li>*Make sure the <b>System &gt; Silence</b> option in the monitor menu is on.</li> <li>*While transferring via HDMI port but no sound is outputted, it is recommended to select AUDIO</li> </ul>

SOURCE as a DIGITAL optional , and make sure PC audio output cable is connected to monitor's LINE IN port(or AUDIO IN port). [For HDMI Input only]

### Addendum related to Windows 7 / Windows 8

When you encounter display problem under Windows 7/ Windows 8, you need to do the following

1. Make sure your PC computer (Hardware requirement) can support Windows 7/ Windows 8.
2. Make sure your video card can run Windows 7/ Windows 8.
3. If your video card can support Windows 7/ Windows 8, need to install the latest Windows 7/ Windows 8 driver of your video card.

Suggest to do the following:

1. Install the latest Windows 7/ Windows 8 video driver of your video card.
2. Try to use the recommended display resolution that is supported by the monitor.
3. If the recommended display resolution is not working, try the second recommended display resolution.

	1	2
35,56cm / 14" (16:9)	1366×768@60Hz	1366×768@50Hz
39,6cm / 15.6" (16:9)	1366×768@60Hz	1366×768@75Hz
40,64cm / 16" (16:9)	1366×768@60Hz	1366×768@50Hz
43,2cm / 17" (16:10)	1440×900@60Hz	1440×900@75Hz
47cm / 18.5" (16:9)	1366×768@60Hz	1366×768@75Hz
48,3cm / 19" (5:4)	1280×1024@60Hz	1280×1024@75Hz
48,3cm / 19" (16:10)	1440×900@60Hz	1440×900@75Hz
51cm / 20" (16:9)	1600×900@60Hz	1600×900@50Hz
56cm / 22" (16:10)	1680×1050@60Hz	1680×1050@50Hz
54,6cm / 21.5" (16:9)	1920×1080@60Hz	1920×1080@50Hz
58,4cm / 23" (16:9)		
60cm / 23.6" (16:9)		
62,5cm / 24.6 (16:9)		
68,6cm / 27" (16:9)		
70cm / 27.5" (16:10)	1920×1200@60Hz	1920×1200@50Hz

And if you still have display problem after doing the above procedure, please visit Hanns-G support and Service Website: <http://www.hannsree.eu/en/monitors>

Windows is a registered trademark of Microsoft Corporation.

## ERROR MESSAGE & POSSIBLE SOLUTIONS

- **CABLE NOT CONNECTED:**
  1. Check that the signal-cable is properly connected, if the connector is loose, tighten the connector's screws.
  2. Check the signal-cable's connection pins for damage.
  
- **INPUT NOT SUPPORT :**  
Your computer has been set to unsuitable display mode, set the computer to display mode given in the following table.

### **FACTORY PRESET TIMING TABLE:**

MODE	RESOLUTION	HORIZONTAL FREQUENCY (KHz)	VERTICAL FREQUENCY (Hz)
1	640×400 @70Hz	31.469	70.087
2	640×480 @60Hz	31.469	59.940
3	640×480 @67Hz	35.000	66.667
4	640×480 @72Hz	37.861	72.809
5	640×480 @75Hz	37.500	75.000
6	720×400 @70Hz	31.469	70.087
7	800×600 @56Hz	35.156	56.250
8	800×600 @60Hz	37.879	60.317
9	800×600 @72Hz	48.077	72.188
10	800×600 @75Hz	46.875	75.000
11	832×624 @75Hz	49.725	75.000
12	1024×768 @60Hz	48.363	60.004
13	1024×768 @70Hz	56.476	70.069
14	1024×768 @75Hz	60.023	75.029
15	1152×870 @75Hz	68.681	75.062
16	1152×864 @75Hz	67.500	75.000
17	1280×720 @60Hz	45.000	60.000
18	1280×960 @60Hz	60.000	60.000
19	1280×960 @75Hz	74.592	74.443
20	1280×768 @60Hz	47.776	59.870
21	1280×768 @75Hz	60.289	74.893
22	1280×1024 @60Hz	63.981	60.020
23	1280×1024 @75Hz	79.976	75.025
24	1366×768 @60Hz	47.712	60.015
25	1366×768 @60Hz	47.852	59.964
26	1440×900 @60Hz	55.469	59.901
27	1440×900 @75Hz	70.635	74.984
28	1400×1050 @60Hz	64.744	59.948

39	1600×900 @60Hz	55.540	59.978
30	1680×1050 @60Hz	65.290	59.954
31	1920×1080 @60Hz	67.500	60.000
33	3840×2160 @60Hz	74.038	59.950

*(Video mode)*

<b>MODE</b>	<b>RESOLUTION</b>
1	640×480p @60Hz
2	720×480i @60Hz
3	720×480p @60Hz
4	720×576i @50Hz
5	720×576p @50Hz
6	1280×720p @60Hz
7	1920×1080i @50Hz
8	1920×1080i @60Hz
9	1920×1080p @50Hz
10	1920×1080p @60Hz

\*\* We ensure that the monitor can be lighted under interlace signal mode, but we can not guarantee the image quality.

## APPENDIX

### SPECIFICATIONS

LCD Panel	Driving system	TFT Color LCD
	Size	71.1cm / 28" Diagonal
	Pixel pitch	0.16mm(H) × 0.16mm(V)
Video	H-Frequency	30KHz – 80KHz
	V-Frequency	60Hz – 75Hz
Display Colors		1.073Bcolors Colors
Max. Resolution		3840*2160@60Hz
Plug & Play		VESA DDC2B™
Power consumption	ON Mode	≤45W (Typical)
	Power Saving Mode	≤0.5W
	OFF Mode	≤0.5W
Audio output		Rated Power 3.0 W rms (Per channel)
Input Terminal		DP DVI (optional) HDMI 1 (4K) HDMI 2 (1.4)
Maximum Screen Size		Hor. : 620.93mm Ver. : 341.28mm
Power Source		100–240V ~ 3.0A 50–60Hz
Environmental Considerations		Operating Temp: 0° to 40°C Storage Temp.: -20° to 60°C Operating Humidity: 10% to 70%
Dimensions		680.1 (W)×504.1(H)×192(D) mm 26.8 "(W)×19.9 "(H)×7.5 "(D)
Weight (NW)		8.7 kg (19.14 lb)

\*\*\* The above specification is subject to actual product specification and is subject to change without prior notice.

#### NOTES:

The Maximum Resolution will depends on the display card supporting. Related issue can refer to <http://www.hannspree.eu/en/monitors>. FAQ section.