

ZigBee Serial Adapter

ProBee-ZS10

User Guide

Sena Technologies, Inc.

Rev 1.1

<http://www.bluetoothupgrades.de/zigbee/>

ProBee-ZS10 User Guide

Firmware version PTV1.X

Copyright

Copyright 2010 Sena Technologies, Inc. All rights reserved.

Sena Technologies reserves the right to make changes and improvements to its product without providing notice.

Trademark

ProBee™ is a trademark of Sena Technologies, Inc.

Windows® is a registered trademark of Microsoft Corporation.

Ethernet® is a registered trademark of XEROX Corporation.

Notice to Users

When a system failure may cause serious consequences, protecting life and property against such consequences with a backup system or safety device is essential. The user agrees that protection against consequences resulting from system failure is the user's responsibility.

This device is not approved for life-support or medical systems.

Changes or modifications to this device not explicitly approved by Sena Technologies will void the user's authority to operate this device.

Technical Support

Email: support@sena.com

Website: <http://www.sena.com>

Contents

1	INTRODUCTION	8
1.1	About This Document	8
1.2	Overview	8
2	GETTING STARTED.....	10
2.1	Hardware Installation	10
2.1.1	<i>Panel Layout</i>	10
2.1.2	<i>Connecting the panel</i>	11
2.1.3	<i>Powering the panel</i>	11
2.1.4	<i>Attaching Battery Pack to ZS10</i>	12
2.1.5	<i>How to attach battery pack to ZS10</i>	12
2.2	Configuration	13
2.2.1	LED	13
2.2.2	Button	14
2.2.3	Dipswitch	14
2.3	Using Terminal Software for AT Commands.....	15
2.4	Using ProBee Manager for Configuration	17
3	ZIGBEE NETWORK CONFIGURATION.....	18
3.1	Setting up ZS10 as a Coordinator	18
3.1.1	<i>Node Type Selection for Coordinator</i>	19
3.1.2	<i>Channel Mask Configuration for Coordinator</i>	19
3.1.3	<i>PAN ID Configuration for Coordinator</i>	20
3.1.4	<i>Permit Joining</i>	20
3.2	Setting up ZS10 as a Router	21
3.2.1	<i>Node Type Selection for Router</i>	21
3.2.2	<i>Channel Mask Configuration for Router</i>	22
3.2.3	<i>PAN ID Configuration for Router</i>	22
3.2.4	<i>Permit Joining</i>	22
3.3	Setting up ZS10 as an End Device.....	23
3.4	Setting up ZS10 as a Sleepy End Device	23
3.5	ZigBee Security	25
3.5.1	<i>Security Level</i>	26
3.5.2	<i>Link Key</i>	26
3.5.3	<i>Network Key</i>	26
3.5.4	<i>Update Key</i>	26

4	DATA TRANSMISSION.....	27
4.1	Command Mode	27
4.1.1	<i>Unicast</i>	27
4.1.2	<i>Multicast</i>	27
4.1.3	<i>Broadcast</i>	28
4.1.4	<i>Sending Binary Data</i>	28
4.1.5	<i>Display Incoming Message</i>	28
4.2	Data Mode.....	29
4.2.1	<i>Unicast Data Mode</i>	29
4.2.2	<i>Multicast Data Mode</i>	31
4.2.3	<i>Broadcast Data Mode</i>	33
5	AT COMMAND REFERENCE.....	35
5.1	Command Line Format	35
5.2	Standard AT Commands	35
5.2.1	<i>AT</i>	35
5.2.2	<i>ATB</i>	35
5.2.3	<i>ATD</i>	35
5.2.4	<i>ATE</i>	36
5.2.5	<i>ATM</i>	36
5.2.6	<i>ATO</i>	36
5.2.7	<i>ATR</i>	36
5.2.8	<i>ATS</i>	36
5.2.9	<i>ATZ</i>	36
5.2.10	<i>AT&F</i>	36
5.2.11	<i>+++</i>	37
5.3	Node Specific Information	37
5.3.1	<i>AT+LONGADDR</i> or <i>AT+LA</i>	37
5.3.2	<i>AT+SHORTADDR</i> or <i>AT+SA</i>	37
5.3.3	<i>AT+ADDRDISCOVERY</i> or <i>AT+AD</i>	37
5.3.4	<i>AT+OPCH</i> or <i>AT+OC</i>	37
5.3.5	<i>AT+OPPANID</i> or <i>AT+OI</i>	38
5.3.6	<i>AT+OPEPID</i> or <i>AT+OE</i>	38
5.3.7	<i>AT+VERSION</i> or <i>AT+VR</i>	38
5.3.8	<i>AT+PRODUCTNAME</i> or <i>AT+PN</i>	38
5.4	Network Specific Parameters	38
5.4.1	<i>AT+CHMASK</i> or <i>AT+CM</i>	38
5.4.2	<i>AT+PANID</i> or <i>AT+PI</i>	39
5.4.3	<i>AT+EPID</i> or <i>AT+EI</i>	39
5.4.4	<i>AT+GROUPEPID</i> or <i>AT+GI</i>	39

5.4.5	<i>AT+POWER or AT+PW</i>	39
5.4.6	<i>AT+STACK or AT+ZS</i>	39
5.4.7	<i>AT+NODENAME or AT+NN</i>	40
5.5	Network Formation and Join	40
5.5.1	<i>AT+ASCAN or AT+AS</i>	40
5.5.2	<i>AT+ESCAN or AT+ES</i>	40
5.5.3	<i>AT+DSCAN or AT+DS</i>	40
5.5.4	<i>AT+NODETYPE or AT+NT</i>	41
5.5.5	<i>AT+PERMIT or AT+PJ</i>	41
5.5.6	<i>AT+LEAVE or AT+LV</i>	41
5.6	End-device	41
5.6.1	<i>AT+SLEEP or AT+SM</i>	41
5.6.2	<i>AT+PARENTLA or AT+PL</i>	41
5.6.3	<i>AT+PARENTSA or AT+PS</i>	42
5.6.4	<i>AT+CHILDTABLE or AT+CT</i>	42
5.7	Data Transmission and Reception.....	42
5.7.1	<i>AT+DESTLA or AT+DL</i>	42
5.7.2	<i>AT+DESTGROUPLD or AT+DG</i>	42
5.7.3	<i>AT+SINKINFO or AT+SI</i>	42
5.7.4	<i>AT+MAXPAYLOAD or AT+MP</i>	43
5.7.5	<i>AT+TRASNSMITMODE or AT+TM</i>	43
5.7.6	<i>AT+UNICAST or AT+UC</i>	43
5.7.7	<i>AT+MULTICAST or AT+MC</i>	43
5.7.8	<i>AT+BROADCAST or AT+BC</i>	43
5.7.9	<i>AT+REMOTE or AT+RC</i>	43
5.8	UART	44
5.8.1	<i>AT+BAUDRATE or AT+UB</i>	44
5.8.2	<i>AT+DATABIT or AT+UD</i>	44
5.8.3	<i>AT+PARITY or AT+UP</i>	44
5.8.4	<i>AT+STOPBIT or AT+US</i>	44
5.8.5	<i>AT+FLOWCTRL or AT+UF</i>	45
5.9	Security	45
5.9.1	<i>AT+SECURITY or AT+SE</i>	45
5.9.2	<i>AT+LINKKEY or AT+LK</i>	45
5.9.3	<i>AT+NWKKEY or AT+NK</i>	45
5.9.4	<i>AT+UPDATEKEY or AT+UK</i>	45
5.10	Firmware Upload and Help	46
5.10.1	<i>AT+BOOTLOAD or AT+BL</i>	46
5.10.2	<i>AT+HELP or AT+HP</i>	46

6	AT COMMAND EXAMPLES.....	47
6.1	Network configuration	47
6.1.1	Coordinator.....	47
6.1.2	Router	47
6.1.3	End-device	47
6.1.4	Sleepy End-device.....	47
6.1.5	Specifying Network	47
6.2	Data Transmission	48
6.2.1	Command Mode	48
6.2.2	Data Mode.....	48
6.3	UART Settings	49
6.4	Security	50
6.5	Firmware Upload	50
6.5.1	Local Node	50
6.5.2	Remote Node	50
6.5.3	Clone.....	51
7	S-REGISTERS.....	52
7.1	Display Options	52
7.1.1	S11.....	52
7.1.2	S12.....	53
7.1.3	S13.....	53
7.1.4	S14.....	53
7.2	Network Settings	53
7.2.1	S21.....	53
7.2.2	S22.....	54
7.2.3	S23.....	54
7.3	Data Transmissions	54
7.3.1	S31.....	54
7.3.2	S32.....	54
7.3.3	S33.....	55
7.3.4	S34.....	55
7.3.5	S35.....	55
7.3.6	S36.....	55
7.3.7	S37.....	56
7.3.8	S38.....	56
7.3.9	S39.....	56
7.4	End Device	56
7.4.1	S51.....	56
7.4.2	S52.....	57

7.4.3	S53.....	57
7.4.4	S54.....	57
7.4.5	S55.....	58
7.4.6	S56.....	58
7.5	Sink	58
7.5.1	S61.....	58
7.5.2	S62.....	58
8	MECHANICAL DRAWINGS.....	60
8.1	ProBee-ZS10 mechanical drawing (mm)	60
8.2	Battery pack mechanical drawing (mm)	61
9	WARRANTY.....	62
9.1	GENERAL WARRANTY POLICY	62
9.2	LIMITATION OF LIABILITY	62
9.3	HARDWARE PRODUCT WARRANTY DETAILS	62
9.4	SOFTWARE PRODUCT WARRANTY DETAILS	63
9.5	THIRD-PARTY SOFTWARE PRODUCT WARRANTY DETAILS	63
10	REGULATORY INFORMATION.....	64
10.1	FCC.....	64
10.2	CE	64
10.3	TELEC	65
10.4	KCC	65
10.5	ZigBee Alliance	65
11	RF INFORMATION	66

1 Introduction

1.1 About This Document

This document provides an introduction on configuration and operation of the ProBee-ZS10 ZigBee Serial Adapter. This document assumes the user is using the ZS10 adapter for evaluation hence the pictures and configuration examples shown in this document are all based on the ZS10 adapter.

This document does not provide full detail of the hardware specifications. Please refer to the ProBee-ZS10 data sheet for further references on the hardware design.

1.2 Overview

The ProBee-ZS10 is an all-in-one ZigBee Serial Adapter with integrated ZigBee core and radio/antenna circuits together with high level software library.

The ZS10 Serial Adapter is designed to meet specific requirements of low cost and low power wireless applications such as home automation or smart energy by adopting the ZigBee technology. The ZS10 is based on the Ember EM250 ZigBee core and fully certified under the latest ZigBee Pro standard for the maximum compatibility.

Despite of its low cost and low power consumptions, the ZS10 provides high performance and robust data transfer capability for wide range of applications. The ZS10 can transfer data at up to 250 kbps and reach up to 5 km (3.1 miles) outdoor line-of-sight.

Key Features

- Integrated 2.4GHz, IEEE 802.15.4-compliant transceiver
- ZigBee Pro Certified
- ZigBee core: Ember EM250
- Transmit Power: +20dBm E.I.R.P (max.)
- Receiver Sensitivity: -102dBm @1% BER
- TX Current: 190mA @3.3V (max.)
- RX Current: 45mA @3.3V (max.)
- Sleep Current: $\leq 2\mu\text{A}$
- Working Distance: 5 km (3.1 miles)
- Various Antenna Options: Dipole 1/3/5dBi
- Full UART Signals Support: UART_TXD/RXD, RTS/CTS, DTR/DSR
- 2 buttons
- 4 dipswitches
- RoHS Compliant

Applications

- Advanced Metering Infrastructure
- Home Area Networks (HAN)
- Neighborhood Area Networks (NAN)
- Home Automation
- Advanced lighting, entertainment, and climate control systems
- Service-based monitoring, security, and awareness systems
- Commercial Building Automation
- Climate & lighting control systems
- Industrial and Domestic Applications

2 Getting Started

Creating a ZigBee network using the ZS10 adapters consists of the following steps:

- Connect a power source to the ZS10 adapter
- Create a ZigBee network by configuring a ZS10 adapter as the coordinator
- Configure ZS10 adapters as routers. This step is optional since the coordinator works as a router too.
- Configure ZS10 adapters as end devices
- Transmit data between ZS10 devices

This chapter describes how to install the ZS10 adapters and how to use terminal software programs to access the ZS10 adapters using AT commands for configurations and operations. The rest of the steps including ZigBee network creation, coordinator/router/end-device configurations and data transmissions are described in the following chapters. The more detailed information on the panel and the configuration examples are also provided in the later chapter.

2.1 Hardware Installation

2.1.1 Panel Layout

Figure 2-1 shows the layout of the panel. The panel provides the interface between the ZS10 and the external serial port with input/output terminals for convenient tests.

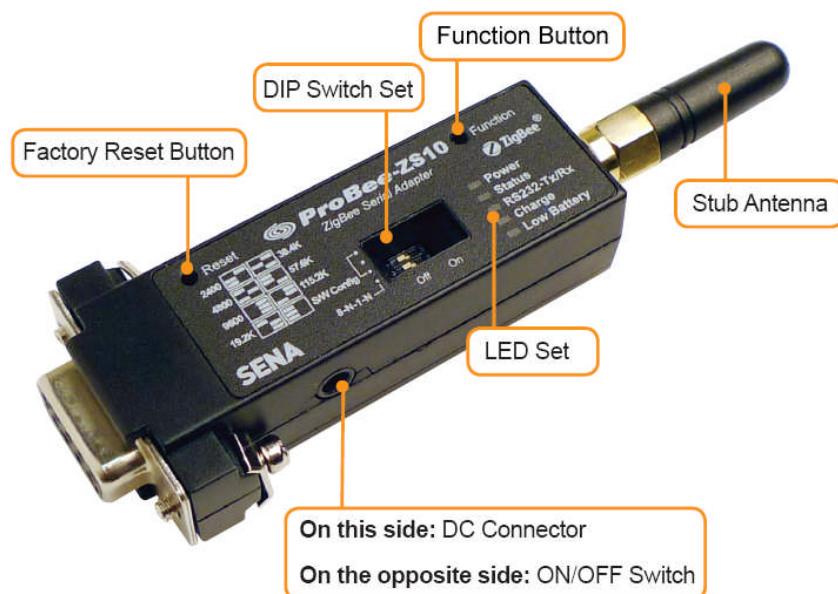

Figure 2-1 Panel Layout of ZS10

2.1.2 Connecting the panel

Please connect the device to your computer directly or using serial cable so AT commands can be sent from the computer to the ZS10 adapter. The serial port of the panel is DB9 male as a DTE terminal.

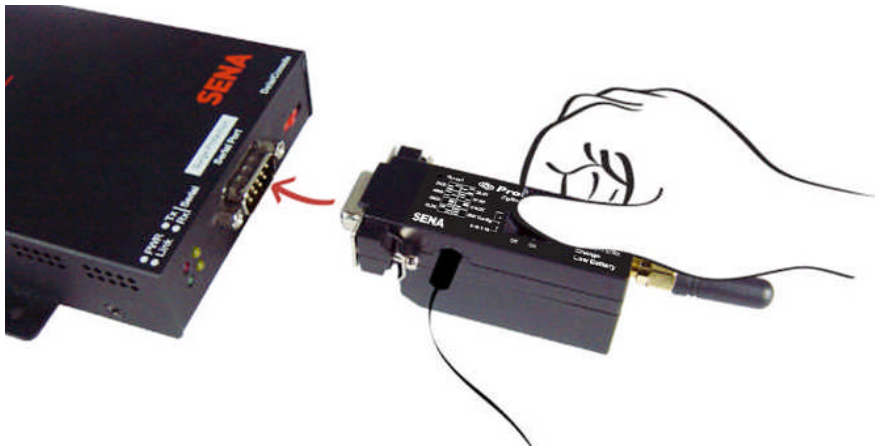

Figure 2-2 Serial Cable Installation

2.1.3 Powering the panel

Once all the installations are completed, please plug in the power connector using the included DC power adapter. Alternatively, the panel can be powered using battery pack.

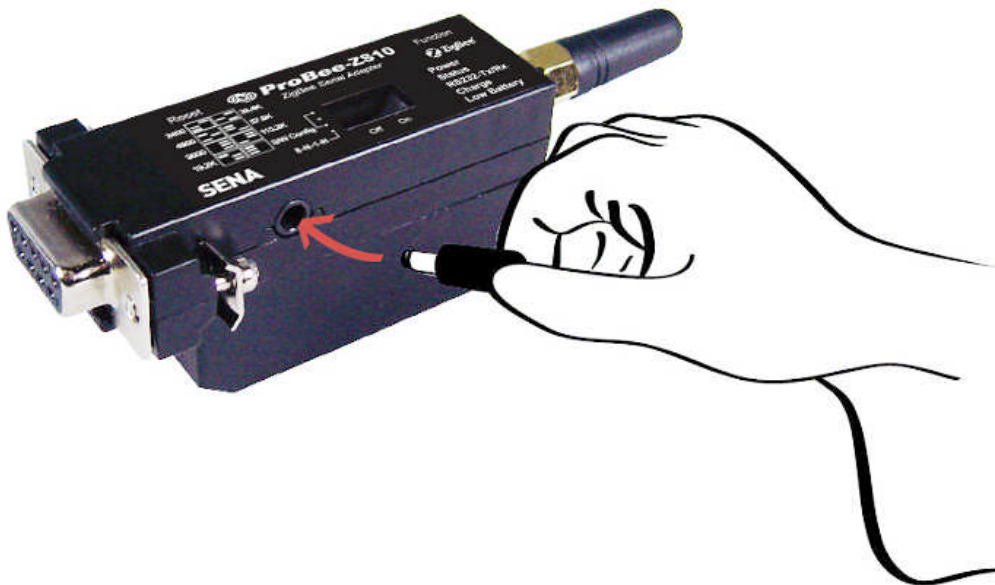

Figure 2-3 Plugging DC Power Adapter

2.1.4 Attaching Battery Pack to ZS10

The ZS10 also supports optional standard battery pack (240mAh) and extended battery pack (900mAh). Attach the battery pack to the ZS10 as shown below to power the ZS10 using the battery pack. To recharge the battery pack, connect the external DC power adaptor as described in Section 2.1.3.



Figure 2-4 Attaching Battery Pack to ZS10

2.1.5 How to attach battery pack to ZS10

Step1. Remove two screws of ZS10 at the bottom and remove the cover.

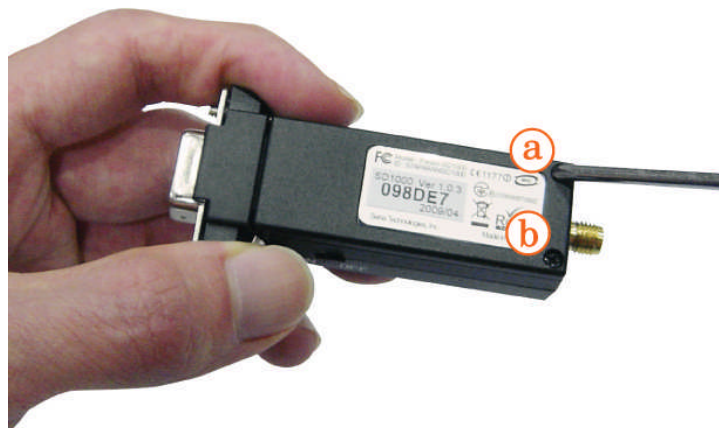

Figure 2-5 Remove ZS10 bottom cover

Step2. Slide the battery pack into the ZS10 slot.

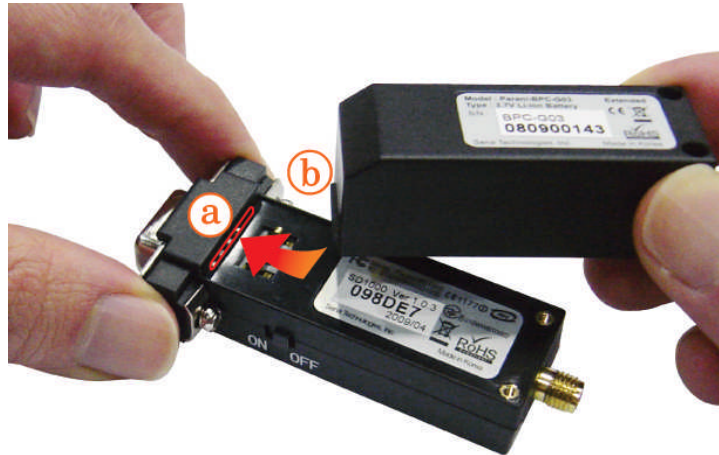

Figure 2-6 Attach the battery pack

Step3. Fasten the battery pack to the ZS10.



Figure 2-7 Fasten the battery pack

2.2 Configuration

2.2.1 LED

RS232-Tx and RS232-Rx LED will flash accordingly when data is transmitted. For small data transmissions, it may be hard to recognize the quick flashing action of the LED. Charge Led and Low battery LED will be off, if you don't use battery pack. The LED indicators are as follows.

Table 2-1 The ProBee-ZS10 LED Indicators

LED	Description
Power	Power LED turns ON when power is supplied. If the node is set to an end-device, it will

	blink periodically. Please refer to 7 S-Registers for S14 regarding the management of the LED status.
Status	Status LED turns ON when the device joins a network, blinks when joining is permitted, and turns OFF when leaves the network. If the node is set to an end-device, it will blink periodically. Please refer to 7 S-Registers for S14 regarding the management of the LED status.
Charge	It will be red if the attached battery pack is charging and turn green when completed.
Low Battery	It will be red if the capacity of the attached battery pack is low.

2.2.2 Button

ZS10 adapter provides 2 buttons for user convenience as below.

Table 2-2 The ProBee-ZS10 Buttons

Button	Description
Reset	This input is dedicated for the factory reset button. If user wants to restore the ZS10 device settings to factory default, this input needs to be pressed for more than two seconds. It will be applied after the input released again. If this button is pressed while the ZS10 starts, the local node enters bootloader menu and it is possible to upload the firmware.
Function	This input is used to permit joining or interrupt sleeping. The functions depend on the node type of the ZS10. If the node is set to coordinator or router, this input works to permit other nodes joining for S-register 22 value. If the node is set to sleepy end-device, it is used for wake-up interrupt signal when the node is sleeping.

2.2.3 Dipswitch

With the combination of 4 slot dipswitches, baud rate, data bit, parity, stop bit and hardware flow control can be set.

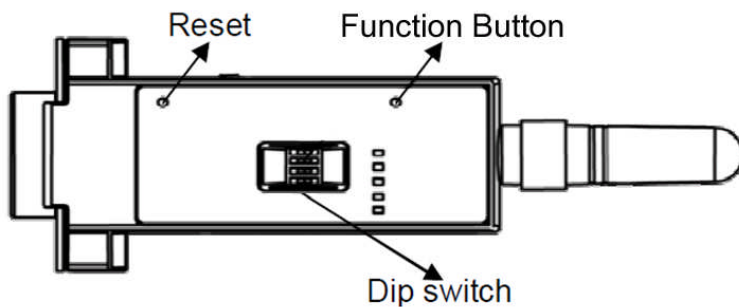

Figure 2-8 The ProBee-ZS10 Dipswitches

Upper 3 dipswitches are used for setting the baud rate, and bottom dipswitch is used for setting data bit,

parity, stop bit and flow control option. If the baud rate needs to a baud rate not shown below, ProBee Manager or terminal program should be used to set these speeds. To set a baud rate not shown below the dipswitches should be in the S/W Config setting. When in the S/W Config setting the baud rate will go back to 9600 as default.

Table 2-3 Baud rate Settings by Dipswitches











	2400	4800	9600	19.2K	38.4K	57.6K	115.2K	S/W Config
Baud rate								

Table 2-4 Data bit, Parity, Stop bit and Flow control Settings by Dipswitch

Set a data bit, parity, stop bit and flow control by AT commands or to the fixed values, 8-N-1-N.	Off (follow AT commands)	On (fix to 8-N-1-N)
		

* Note: You cannot set the ZS10 to a baud rate of 1200 or 230K by way of the dipswitch. If you want to use them, to set these speeds, please configure the dipswitch to S/W Config setting and use ProBee Manager or AT commands. Please refer to ProBee Manager and the section **5.8 UART** for the configuration.

2.3 Using Terminal Software for AT Commands

Once the hardware installation is complete, the ZS10 unit is ready to communicate with the computer using the AT commands using a terminal emulation software. You can use any kind of terminal emulation software. This document assumes HyperTerminal is used. If you are using Windows Vista or 7, HyperTerminal is no longer included in the Windows so you need to download HyperTerminal from the Internet. For more details on HyperTerminal, please refer to Microsoft web page.

Once the HyperTerminal is installed, launch HyperTerminal and select the serial port that is connected to the ZS10 panel and enter the serial settings to use. The default serial settings of the ZS10 are **9600 bps, 8 data bit, none parity, 1 stop bit, hardware flow control**.



Figure 2-9 HyperTerminal Serial Settings

To display the AT commands that are being typed, you need to enable the local echo option on the HyperTerminal. To enable this option, Go to File->Properties->Settings->ASCII setup and select the "Echo typed characters locally" option. To verify the connection, type AT and press the Enter key. If the AT command is accepted by the ZS10, OK string will be displayed on the screen.

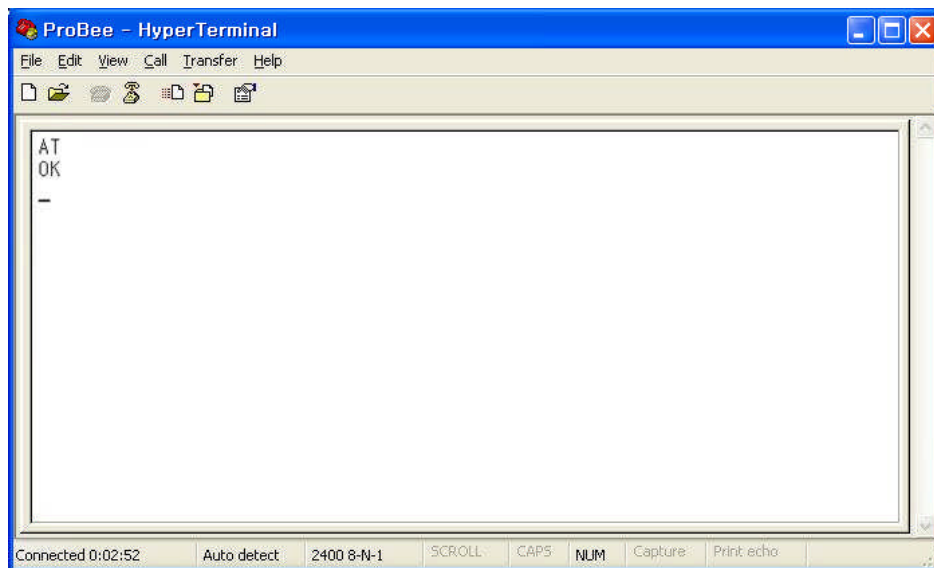

Figure 2-10 Testing AT Command on HyperTerminal

2.4 Using ProBee Manager for Configuration

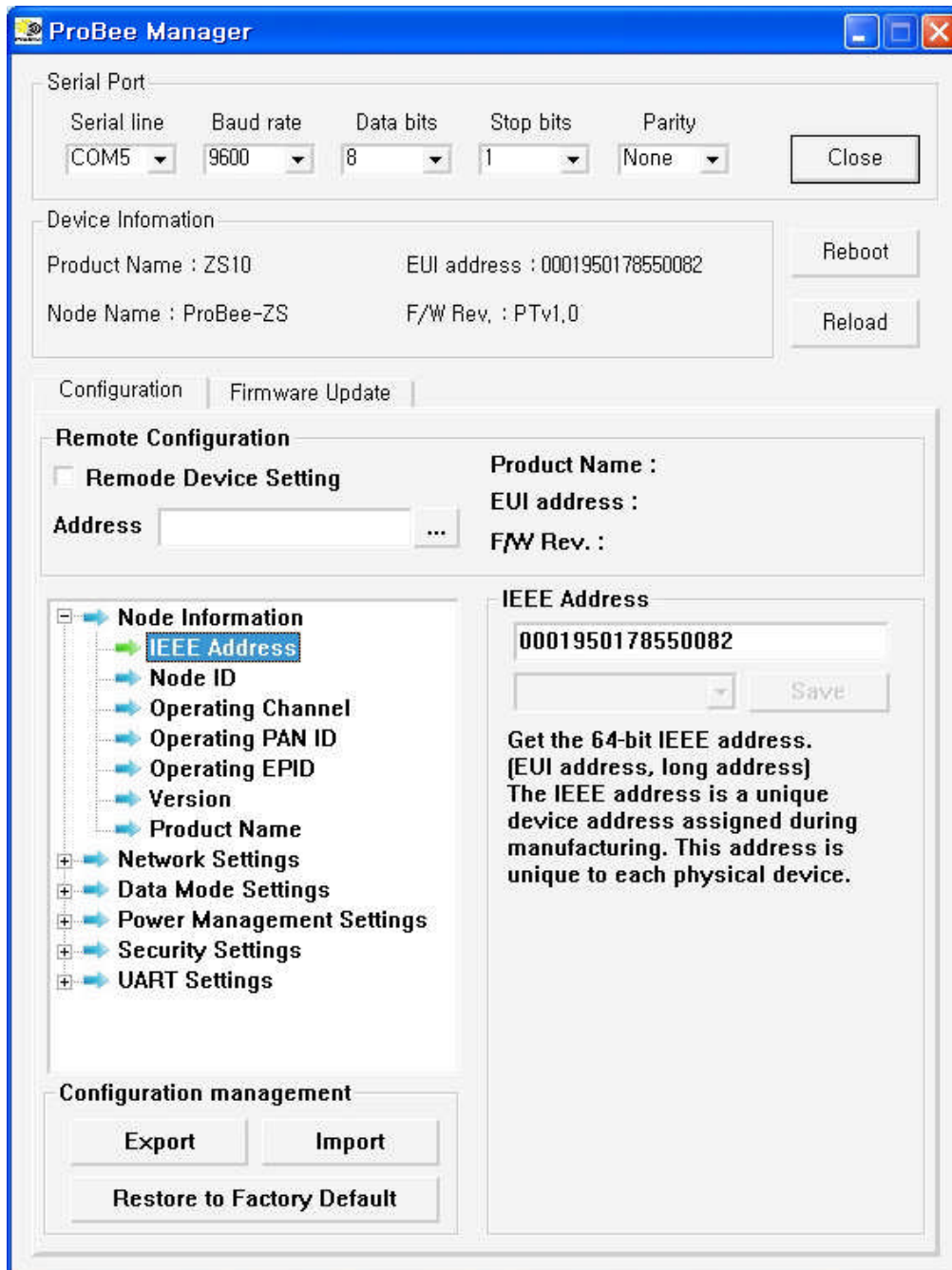

Figure 2-11 ProBee Manager

It is possible to set or get the configurations of the ZS10 using ProBee Manager. This PC utility helps that a user can configure several setting values easily without a terminal program and upload the firmware file to local and/or remote node.

3 ZigBee Network Configuration

A ZigBee Network consists of a coordinator, routers and end devices. A minimal ZigBee network consists of one coordinator and multiple end devices which directly connect to the coordinator. For larger ZigBee networks, routers are required to provide redundant routings to form mesh networks.

- **ZigBee Coordinator:** The coordinator forms the root of the network tree and might bridge to other networks. There is exactly one ZigBee coordinator in each network since the coordinator starts the ZigBee network itself. It also stores information about the network, including acting as the Trust Center & repository for security keys.
- **ZigBee Router:** The routers are able to route messages between other devices. Since the coordinator provides the routing functionality too, the routers are optional to form a ZigBee network.
- **ZigBee End Device:** The end device contains just enough functionality to talk to the parent node which is either the coordinator or a router. It cannot relay data from other devices.
- **ZigBee Sleepy End Device:** The sleepy end device is the same with normal end device except it can stay in the sleep mode much longer. This relationship allows the end device to sleep significant amount of the time and achieve the long battery life.

The ZS10 can be configured to work either as a coordinator, a router or an end device. Once the operation mode of the ZS10 is selected, corresponding parameters need to be set up appropriately. This chapter explains how to configure the ZS10 operation mode and other parameters related to the ZigBee network itself.

Table 3-1 ZigBee Node Types

Node Type	Recommendation when to use ZS10
Coordinator	It should be selected when it is first time to establish the network.
Router	It is recommended when there is a network already and it needs to be expanded. A router is suitable for fast and stable data transmissions and receptions.
End Device	It is recommended when it doesn't need to expand the network anymore and there are enough nodes as parents. An end-device consumes less power than a router.
Sleepy End Device	It is recommended when the data transmissions occur rarely and in very small quantities. A sleepy end device can lose data if sleep duration is too long, but it is possible to consume extremely low power as low as 2uA.

3.1 Setting up ZS10 as a Coordinator

A coordinator relays messages and can act as a parent to other nodes. Every personal area network (PAN) must be started by a node acting as the coordinator. This device is normally always powered on. To set up the ZS10 to work as the coordinator, please follow the steps as below

- Configure the ZS10 node type as the coordinator
- Optionally, select the channel mask. Otherwise, the ZS10 will use the default channel mask.
- Optionally, set up the PAN ID and/or the extended PAN ID. Otherwise, the ZS10 will generate the PAN ID and/or the extended PAN ID automatically.
- Permit joining when other router or end device tries to join the ZigBee network.

3.1.1 Node Type Selection for Coordinator

The ZS10 adapter can be configured as a ZigBee coordinator by the AT command as below:

AT+NODETYPE=n or AT+NT=n

Where n is 0 = none, 1 = coordinator, 2 = router, 3 = end-device, 4 = sleepy end-device

After the operation mode is selected, ATZ command should be performed to reset the unit to have the change applied.

Example)

```
AT+NODETYPE=1<CR>      # Set node type as the coordinator
OK<CR>                 # Response
ATZ<CR>                # Apply the change
OK<CR>                 # Response
```

3.1.2 Channel Mask Configuration for Coordinator

When the ZigBee coordinator starts, it scans predefined frequency channels to find the best frequency channel to use without causing interference with other wireless devices. The user is able to specify the channels to use with the AT command as below:

AT+CHMASK=n

Where n = channel mask to use. Default = 0x03FFF000

This value has a 32-bit hexa decimal unsigned integer. Each bit represents whether a channel will be used or not. For example, to use a channel between 12 and 15, the 12, 13, 14 and 15 bits of the channel mask should be 1 and all other bits should be 0. The default setting is 0x3FFF000 which means that all the channels from 12 to 25 can be used. The ZS10 supports only the channels between 12 and 25, so 0~11 bits and 26~31 bits should be 0. Table 3-2 shows the bit mask for each channel.

Table 3-2 Channel Bitmask

Channel	12	13	14	15	16	17	18
Bit mask	00001000	00002000	00004000	00008000	00010000	00020000	00040000
Channel	19	20	21	22	23	24	25
Bit mask	00080000	00100000	00200000	00400000	00800000	01000000	02000000

3.1.3 PAN ID Configuration for Coordinator

Every ZigBee network should be assigned a PAN ID to identify the network. If the PAN ID is 0000, the ZS10 will generate a random 16-bit PAN ID to start the ZigBee network. Otherwise, the user can enter the PAN ID using the AT command as below:

AT+PANID=xxxx

Where *xxxx* is PAN ID to use. For example, 12AB. Default setting is 0000

When choosing a PAN ID, the user needs to make sure that there is no ZigBee network using the same PAN ID. If the PAN ID is already used by another ZigBee network, the PAN ID is unavailable and the user should choose a new PAN ID. In order to avoid this, PAN ID auto-generation is strongly recommended.

The user can also assign the 64-bit extended PAN ID to the ZS10 using the AT command below. If the extended PAN ID is 0000000000000000, the ZS10 uses its IEEE address as the extended PAN ID. The extended PAN ID cannot be shared with other ZigBee networks either.

AT+EPID=xxx...xxx

Where *xxx...xxx* is EPID to use. For example, 0123456789ABCDEF. Default setting is 000...000.

3.1.4 Permit Joining

When a router or an end device tries to join the ZigBee network, there should be at least one coordinator or router which is permitting joining. If there is no router in the ZigBee network yet, the coordinator should permit joining. The ZS10 provides three ways to permit joining are as follows:

- Permanently permitting by configuration
- Transiently permitting by AT command
- Transiently permitting by digital input signal

If joining is permanently permitted, any device can join anytime. Since this will allow even an unidentified device to join the network anytime, this mode should be selected with extra caution. The AT command to permit joining permanently is as follows:

AT+PERMIT=255 or AT+PJ=255

The user can permit joining for a moment at need. The AT command to permit joining is

AT+PERMIT= n or AT+PJ= n

Where n is the duration to permit in seconds ranging 1~254 seconds.

The user can also use the function button to permit joining. When the button pressed, the ZS10 permits joining for the duration that is configured in S-register 22 (S22). The AT command to change the duration is as follows:

ATS22= n

Where n is the duration to permit in seconds ranging 1~254 seconds. Default is 60.

S22 value determines the time that the device will allow other devices to join to it. If set to 255, the device will always permit other nodes joining. If the user reboots the coordinator (or a router), the device allows other nodes to join the network for the period defined by S-register 22.

Note: When a device that has joined a network reboots, the device is able to join the network regardless of permitting. But, after the device has joined other network, rejoining the previous network should be permitted by the coordinator or a router.

3.2 Setting up ZS10 as a Router

A router is a full-function routing device that relays messages and can act as a parent to other nodes. These devices must be always powered on.

To configure the ZS10 as a ZigBee router, please follow the steps below.

- Configure the ZS10 node type as a router.
- Optionally, select the channel mask. Otherwise, the ZS10 will use the default channel mask.
- Optionally, set up the PAN ID and/or the extended PAN ID. Otherwise, the ZS10 will scan and join the ZigBee network found automatically.
- Permit joining when other router or end device tries to join the ZigBee network.

3.2.1 Node Type Selection for Router

The ZS10 adapter can be configured as a ZigBee router by the AT command as below:

AT+NODETYPE= n or AT+NT= n

Where n is 0 = none, 1 = coordinator, 2 = router, 3 = end-device, 4 = sleepy end-device

After the operation mode is selected, ATZ command should be performed to reset the unit to have the change applied.

Example)

```
AT+NODETYPE=2<CR>      # Select router mode
OK<CR>                 # Response
ATZ<CR>                # Apply the change
OK<CR>                 # Response
```

3.2.2 Channel Mask Configuration for Router

When the ZS10 as a ZigBee router or a ZigBee end device tries to join, it scans all the channels configured by channel mask to find the ZigBee network to join. The channel mask of router or end device should include the channel on which the coordinator is operating. For example, we assume that the coordinator of the network to join is operating on channel 12. The router or end device trying to join should has a channel mask of which 12th bit is 1

3.2.3 PAN ID Configuration for Router

The PAN ID of a ZigBee router or a ZigBee end device should be the same with the PAN ID of the ZigBee coordinator. If the coordinator is using a randomly generated PAN ID, the user can get the operating PAN ID by running the AT command below on the coordinator:

AT+OPPANID

If the PAN ID of a ZigBee router or a ZigBee end device is 0000, the PAN ID is ignored. After checking the PAN ID, the ZS10 trying to join compares the extended PAN ID to make sure whether the network is the right network to join. If the extended PAN ID is the same with its configured extended PAN ID, it will try to join the network. Otherwise, it will try to find another network. The user can get the operating extended PAN ID by running the AT command below on the coordinator:

AT+OPEPID

If the extended PAN ID of a ZigBee router or a ZigBee end device is 0000000000000000, the extended PAN ID is ignored

3.2.4 Permit Joining

The ZigBee router is configured and works the same way with the coordinator to permit joining of other nodes. Please refer to the section **3.1.4 Permit Joining** for the configuration

3.3 Setting up ZS10 as an End Device

An end device is a leaf node which communicates only with its parent node and will not relay messages directly. To configure the ZS10 as a ZigBee end device, please follow the steps below.

- Configure the ZS10 node as an end device
- Optionally, select the channel mask. Otherwise, the ZS10 will use the default channel mask.
- Optionally, set up the PAN ID and/or the extended PAN ID. Otherwise, the ZS10 will scan and join the ZigBee network found automatically.
- Configure the poll timeout and the poll period

Please refer to the section **3.2 Setting up ZS10 as a Router** for the AT commands regarding the node type selection through the PAN ID configurations.

When an end device joins the network, the power LED blinks periodically. The end device belongs to a parent node which is either the coordinator or a router, and the parent node registers the end device to its internal child table for message relaying. This table is maintained as long as the end device polls the parent node periodically within the poll timeout value of the parent node. If the end device does not poll for the poll timeout value of the parent node, the parent node removes the end device from its child table and does not relay the message any more. Hence, the poll period of the end device should be equal or shorter than the poll timeout of the parent node to avoid accidental removal of the end device from the parent node's child table.

The ZS10 poll interval can be configured by setting the S-registers using the AT commands as below.

ATS51=n, where n is poll timeout in seconds and the default is 60.

ATS56=n, where n is poll period in seconds and the default is 5.

End device polls the parent node at poll period defined by S56 periodically. It is for the connection to the parent node and data transmission with other nodes in the network.

Even though the end device needs to poll the parent node continuously, it does not go into the sleep mode and it can send and receive messages any time unlike the sleepy end device.

3.4 Setting up ZS10 as a Sleepy End Device

A sleepy end device can turn off radio to save power. To configure the ZS10 as a ZigBee sleepy end device, please follow the steps below.

- Configure the ZS10 node as a sleepy end device.
- Optionally, select the channel mask. Otherwise, the ZS10 will use the default channel mask.
- Optionally, set up the PAN ID and/or the extended PAN ID. Otherwise, the ZS10 will scan and join

- the ZigBee network found automatically.
- Configure the settings for sleep interval.

Please refer to the section **3.2 Setting up ZS10 as a Router** for the AT commands regarding the node type selection through the PAN ID configurations.

One of the unique features of the ZigBee device is its extreme low power consumption which is mainly achieved by its efficient sleep and wake-up mechanism. While ZigBee coordinator and routers are required to be in operation always, ZigBee sleepy end devices can be configured to be in the sleep mode most of the time and only wake up at pre-configured time interval for data transmission before it goes into the sleep mode again. The ZS10 sleep interval can be configured by setting the S-registers using the AT commands as below.

ATS51=n, where n is poll timeout in seconds and the default is 60.

This value is for a parent node only. If an end device does not send a poll request to its parent coordinator or router within the poll timeout, the end device is removed from the child table. Unlike the non-sleepy end device, sleepy end device does not use S51 as the poll period. Instead, it uses S53 as the sleep duration which works similar to the poll period, except it goes to sleep mode.

ATS53=n, where n is sleep duration in quarter seconds and the default is 8.

The ZS10 sleeps at sleep duration and turns off radio.

ATS52=n, where n is poll period in milliseconds and the default is 100.

Sleepy end device wakes up from the sleep mode if S53 timer expires or function button is pressed or serial data is received. Once the sleepy end device wakes up, it polls the parent node at poll period defined by S52 until it goes to sleep mode again. Since the sleepy end device exchanges data with the parent node only by polling, S52 poll period is usually configured as around 100 ms.

ATS54=n, where n is standby timeout in seconds and the default is 5.

If there is no RF data or serial data for S54 seconds, the sleepy end device goes to sleep mode again. If any serial or RF data is sent or received, the timer will reset and the sleepy end device waits for another S54 seconds before it goes to sleep mode again.

ATS55=n, where n is rejoin timeout and the default is 10.

When the connection to the parent node is broken for S55 in seconds, the child node tries to rejoin the current network.

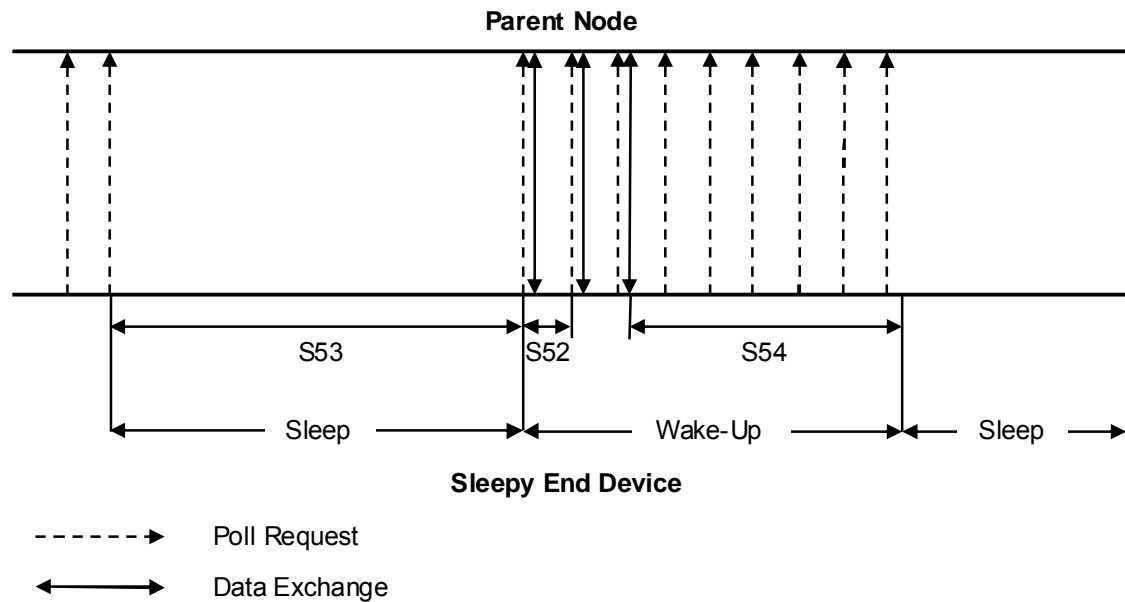

Figure 3-1 Sleep Interval and Wake-up Timing

The sleepy end device can also wake up from the sleep mode by function button interrupt or incoming serial data. Once it wakes up, it also polls with the parent node at S52 interval and goes into sleep mode after S54 time elapses after the last data exchange.

Note: If the sleepy end device wakes up by incoming serial data, the integrity of the first incoming byte is not guaranteed. It is strongly recommended to wake up the sleepy end device by using function button first before sending the serial data or use higher level serial data protocol to check the data integrity.

3.5 ZigBee Security

Security is a major concern in the ZigBee architecture. Although ZigBee uses the basic security elements in IEEE 802.15.4 (e.g., AES encryption & CCM security modes), the ZS10 increase the security level with:

- 128 bit AES encryption algorithms
- Strong, NIST-approved security
- Defined Key Types (Link, Network)
- Defined Key setup and maintenance
- CCM (Unified/Simpler mode of operation)
- Trust Centers

3.5.1 Security Level

In order to use security in the application, a user should set security level using the AT command below. Set 1 defines both Authentication and Encryption at the network layer. Set 0 defines no security. Disabling security in the application is not ZigBee compliant. All nodes in the network should have the same security level setup. The security level is configured using the AT command below.

AT+SECURITY= n , where n is encryption level. (0=disable, 1=enable)

3.5.2 Link Key

The trust center (normally coordinator in network) requests link key before a device is trying to join network. If link key the device has is wrong, joining process will be denied. Hence, all nodes in the network should have the same link key setup before joining the network.

AT+LINKKEY= $xxx\cdots xxx$, where $xxx\cdots xxx$ is 128-bit hexadecimal trust center link key. Default is FFF \cdots FF

3.5.3 Network Key

It is the network-wide key used to secure transmissions at the Network Layer. The network key encrypts all transmissions at the Network Layer. The network key only needs to be set up for the coordinator.

AT+NWKEY= $xxx\cdots xxx$, where $xxx\cdots xxx$ is 128-bit hexadecimal network key. Default is FFF \cdots FF

3.5.4 Update Key

A trust center can update the Network Key to help minimize the risk associated with a particular instance of the network key being compromised. Key updates are broadcast by the trust center throughout the network, encrypted using the current network key. Devices that hear the broadcast will not immediately use the key, but simply store it. Later, a key switch is broadcast by the trust center to tell all nodes to start using the new key. At a minimum, the trust center should allow adequate time for the broadcast of the new key to propagate throughout the network before switching.

AT+UPDATEKEY<CR>

4 Data Transmission

The ZS10 supports three different types of data transmissions: unicast, multicast and broadcast. Unicast is to transmit data to a specific ZigBee device. Multicast is to transmit data to a group of ZigBee devices that are assigned a specific group ID. Broadcast is to transmit data to all ZigBee devices (or specific type of ZigBee nodes if specified) in the network.

There are also two different methods to transmit data to other device as below:

- Command mode: It sends only one packet up to allowed payload length by a form of command.
- Data mode: It is possible to send data consecutively until leave the data mode using “+++”.

4.1 Command Mode

4.1.1 Unicast

Unicast transmissions are sent from a source device to a destination device. The destination device can be any ZigBee device in the ZigBee network. To specify the destination device, the ZigBee address of the destination device should be known.

There are two different ZigBee addresses assigned to each ZigBee device. The 64-bit address is a unique device address assigned during manufacturing. The 64-bit address is also called IEEE address or extended address. The 16-bit address is assigned to the device when it joins a ZigBee network. The ZS10 can send unicast messages based on either 16-bit address or 64-bit address. The AT command for the unicast transmissions is as below:

```
AT+UNICAST=<node_id>,<MSG><CR>
```

Where <node_id> = 16-bit or 64-bit address, <MSG> = data to transmit

The maximum payload of the message is 90 bytes (or 72 bytes under security enabled). If the message length exceeds the maximum payload, the message cannot transmit and the error message will be presented.

4.1.2 Multicast

Multicast transmissions are sent from a source device to destination devices with the specific group ID. The group ID is assigned to the devices using the AT+GROUPID command. The AT command for the multicast transmissions is as below.

```
AT+MULTICAST=<group_id>,<MSG><CR>
```

Where <group_id> = group ID, <MSG> = data to transmit

The data transmission range can be set using the AT commands below. Please refer to the **7 S-Registers** for more details.

ATS36=n, where n is the radius.

ATS37=n, where n is the number of hops through nonmembers.

4.1.3 Broadcast

Broadcast transmissions are sent from a source device to all devices in the ZigBee network. The AT command for the broadcast transmissions is as below.

AT+BROADCAST=<MSG><CR>

Where <MSG> = data to transmit

The user can also specify the transmit range by changing the S35 register value as below. Please refer to the **7 S-Registers** for more details.

ATS35=n, where n is the broadcast range.

ATS36=n, where n is the radius.

4.1.4 Sending Binary Data

There are some characters, e.g. carriage return, line feed and back space, that are not allowed or have special meanings in command mode. In order to transmit these characters in command mode, these characters must be encoded in a command line. The special characters encoding table is shown in Table 4-1.

Table 4-1 Special Characters Encoding Table

HEX	Abbreviation	Glyph	Encoded	Description
00	NULL	-	\00	Null character
0D	CR	-	\0D	Carriage return
0A	LF	-	\0A	Line feed
08	BS	-	\08	Backspace
09	HT	-	\09	Horizontal Tab
7F	DEL	-	\7F	Delete
5C	-	\	\5C	Control character for binary encoding

For example, when sending *abc<CR>* with AT+BROADCAST command, the command should be as follows:

AT+BROADCAST=abc\0D<CR>

4.1.5 Display Incoming Message

S11 register determines whether incoming message will be presented or not in the command mode. In

the data mode, on the other hand, incoming data is always displayed. To change the S11 register, please use the AT command as below:

ATS11=<value><CR>,

where <value> = 0 to hide incoming message, 1 to show incoming message.

If user wants to display incoming message in command mode, S11 should be enabled. It is presented by a form of *+<IEEE address>|<MSG><CR>*.

When displaying incoming messages in command mode, some characters are encoded in the same way with sending binary data as in Table 4-1. For example, when receiving *abc<CR>* from 0001950000000001, the displaying message is as follows:

+0001950000000001|abc\0D<CR>

4.2 Data Mode

If the data is too long to send using the command mode, Data Mode can be used instead. Once the ZS10 enters a Data Mode session, the ZS10 can send data continuously to a specific node or current network until the data mode is escaped. The data is packetized and transmitted at every inter-character timeout. This data link to the designated device is maintained until the escape command “+++” is entered. To return to the last data mode after the ZS10 is escaped by “+++”, use the AT command as below.

ATO<CR>

4.2.1 Unicast Data Mode

Unicast data mode can be used for continuous data transmission to a particular node. Unicast data mode can be entered using either ATD or AT+TRANSMITMODE=1 (or 4). If ATD command is used, the device will enter the unicast data mode immediately until escaped using “+++” or reset by ATZ. If the device is reset, it will not enter the unicast data mode in this case.

On the other hand, if AT+TRANSMITMODE=1 (or 4) is used to enter the unicast data mode, the device enters the unicast data mode again whenever the device is reset. To disable the unicast data mode, escape the data mode first by using “+++” string and use AT+TRANSMITMODE=0 and reset the device to apply the setting permanently.

AT commands used for the unicast data mode are as below.

AT+DESTLA=<value>

Set the destination address, where <value> is 64-bit IEEE address of destination node for unicast data mode.

ATD<CR>

Set unicast data mode to the preconfigured destination IEEE address without reset.

ATD<value><CR>

Set unicast data mode and <value> can be either 16-bit node ID or 64-bit IEEE address of remote node.

AT+TRANSMITMODE=1<CR>

Set the transmit mode to unicast to a destination IEEE address. The device should be reset to apply the mode.

AT+TRANSMITMODE=4<CR>

Set the transmit mode to unicast to a sink node. A sink node is determined if s-register 61 is set. The device should be reset to apply the mode.

Example)

```
AT+DESTLA=00019500002FDC40<CR> # Set the destination IEEE address
OK<CR> # Response
ATD<CR> # Enter the unicast mode using destination IEEE address
OK<CR> # Response
Send unicast msg # Put the unicast message
+++ # Leave data mode
OK<CR> # Response
```

```
ATD0000<CR> # Enter the unicast mode using 16-bit node ID
OK<CR> # Response
Send unicast msg # Put the unicast message
+++ # Leave data mode
OK<CR> # Response
```

```
ATD00019500002FDC40<CR> # Enter the unicast mode using 64-bit IEEE address
OK<CR> # Response
Send unicast msg # Put the unicast message
+++ # Leave data mode
OK<CR> # Response
```

```
AT+DESTLA=00019500002FDC40<CR> # Set the destination IEEE address
OK<CR> # Response
```

```

AT+TRANSMITMODE=1<CR> # Set transmit mode to destination IEEE address
OK<CR>                 # Response
ATZ<CR>                # Apply to change
OK<CR>                 # Response
Send unicast msg      # Put the unicast message
+++                    # Leave data mode
OK<CR>                 # Response

```

```

AT+TRANSMITMODE=4<CR> # Set transmit mode to sink node in the network
OK<CR>                 # Response
ATZ<CR>                # Apply to change
OK<CR>                 # Response
Send unicast msg      # Put the unicast message
+++                    # Leave data mode
OK<CR>                 # Response

```

4.2.2 Multicast Data Mode

Multicast data mode can be used for continuous data transmission to a particular group of multiple devices. Every ZS10 belongs to a certain group by predetermined group ID when form or join the network.

Multicast data mode can be entered using either ATM or AT+TRANSMITMODE=2. If ATD command is used, the device will enter the multicast data mode immediately until escaped using “+++” or reset by ATZ. If the device is reset, it will not enter the multicast data mode in this case.

On the other hand, if AT+TRANSMITMODE=2 is used to enter the multicast data mode, the device enters the multicast data mode again whenever the device is reset. To disable the multicast data mode, escape the data mode first by using “+++” string and use AT+TRANSMITMODE=0 and reset the device to apply the setting permanently.

AT commands used for the multicast data mode are as below.

AT+GROUPID=<value>, where <value> is 16-bit group ID for multicast data mode.

Set Group ID of the device. The device will receive the multicast data sent to this Group ID.

AT+DESTGROUPID=<value>, where <value> is 16-bit destination group ID for multicast data mode.

Set destination Group ID of the device.

ATM<CR>

Set multicast data mode to preconfigured destination group ID without reset

ATM<value><CR>

Set multicast data mode and <value> can be 16-bit group ID.

AT+TRANSMITMODE=2<CR>

Set the transmit mode to multicast mode. The device should be reset to apply the mode.

ATS36=n, where *n* is the radius.

ATS37=n, where *n* is the number of hops through nonmembers.

Set data relay and forwarding options. Please refer to the **7 S-Registers** for more details.

Example)

```
AT+DESTGROUPID=0001<CR>    # Set the destination group ID
OK<CR>                      # Response
ATM<CR>                     # Enter the multicast mode using destination group ID
OK<CR>                      # Response
Send multicast msg          # Put the multicast message
+++                          # Leave data mode
OK<CR>                      # Response
```

```
ATM0001<CR>                 # Enter the multicast mode using 16-bit group ID
OK<CR>                      # Response
OK<CR>                      # Response
Send multicast msg          # Put the multicast message
+++                          # Leave data mode
OK<CR>                      # Response
```

```
AT+DESTGROUPID=0001<CR>    # Set the destination group ID
OK<CR>                      # Response
AT+TRANSMITMODE=2<CR>     # Set transmit mode to destination group ID
OK<CR>                      # Response
ATZ<CR>                    # Apply to change
OK<CR>                      # Response
Send multicast msg          # Put the multicast message
+++                          # Leave data mode
OK<CR>                      # Response
```

4.2.3 Broadcast Data Mode

Broadcast data mode can be used for continuous data transmission to all devices in the current network. The destination address or group ID of the remote nodes is not necessary for broadcast data mode. The transmit range is determined by the S-register 35.

Broadcast data mode can be entered using either ATB or AT+TRANSMITMODE=3. If ATB command is used, the device will enter the broadcast data mode immediately until escaped using “+++” or reset by ATZ. If the device is reset, it will not enter the broadcast data mode in this case.

On the other hand, if AT+TRANSMITMODE=3 is used to enter the broadcast data mode, the device enters the broadcast data mode again whenever the device is reset. To disable the broadcast data mode, escape the data mode first by using “+++” string and use AT+TRANSMITMODE=0 and reset the device to apply the setting permanently.

AT commands used for the broadcast data mode are as below.

ATB<CR>

Set broadcast data mode.

AT+TRANSMITMODE=3<CR>

Set the transmit mode to broadcast. It should be reset to apply the mode.

ATS35=n, where *n* is the broadcast range.

ATS36=n, where *n* is the radius.

Set data transmission range. Please refer to the chapter **7 S-Registers** for more details.

Example)

```
ATS35=2<CR>           # Set broadcast range to all nodes in the network
OK<CR>                # Response
ATB<CR>              # Enter the broadcast mode
OK<CR>                # Response
Send broadcast msg    # Put the broadcast message
+++                  # Leave data mode
OK<CR>                # Response
```

```
AT+TRANSMITMODE=3<CR> # Set transmit mode to current network
OK<CR>                # Response
```

```
ATZ<CR>          # Apply to change
OK<CR>           # Response
Send broadcast msg # Put the broadcast message
+++             # Leave data mode
OK<CR>          # Response
```

5 AT Command Reference

5.1 Command Line Format

Each command line is composed of a prefix, body and terminator. Only “AT” can be used for the prefix. The body is a string of characters. The terminator is <CR> or <NL>. A command can be one of the followings:

- Read a configuration parameter:
AT<Command>?<CR>
- Do something:
AT<Command><CR>
- Write a configuration parameter:
AT<Command>=<Parameter 1>,<Parameter 2>,<Parameter 3>,...<CR>

Commands denoted with a “+” character are extended AT commands.

S-registers are supported. Multiple commands in the same command line are not supported.

5.2 Standard AT Commands

5.2.1 AT

Description	Check the state of the connection between host and ProBee device.
Execute	AT<CR>
Response	OK<CR>

5.2.2 ATB

Description	Enter the broadcast data mode. Every data is packetized at intervals of inter character timeout (S12) and transmit range is determined by broadcast range(S35).
Execute	ATB<CR>
Response	OK<CR>

5.2.3 ATD

Description	Enter the unicast data mode to specific node. If there's no argument after the command, it will connect to the preconfigured destination IEEE address. Successful transmission guarantees successful reception and every data is packetized at intervals of inter character timeout(S12).		
Execute	ATD<CR>	ATD<nodeID><CR>	ATD<IEEE><CR>
Response	OK<CR> or ERROR<CR>		

5.2.4 ATE

Description	Echo(1) or No Echo(0).
Execute	ATE<number><CR>
Response	OK<CR>

5.2.5 ATM

Description	Enter the multicast mode. If there's no argument after the command, it will connect to the preconfigured destination group ID. Every data is packetized at intervals of inter character timeout(S12).	
Execute	ATM<CR>	ATM<groupID><CR>
Response	OK<CR>	

5.2.6 ATO

Description	Return to data mode.
Execute	ATO<CR>
Response	

5.2.7 ATR

Description	Response(1) or No Response(0).
Execute	ATR<number><CR>
Response	OK<CR>

5.2.8 ATS

Description	Get/Set the S-registers.		
Execute	ATS<CR>	ATS<number>?<CR>	ATS<number>=<value><CR>
Response	List of the S-register and description	<value><CR> OK<CR>	OK<CR> or ERROR<CR>

5.2.9 ATZ

Description	Reset the node.
Execute	ATZ<CR>
Response	OK<CR>

5.2.10 AT&F

Description	Factory reset.
Execute	AT&F<CR>
Response	OK<CR>

5.2.11 +++

Description	Interrupt data mode. “+++” must be entered within 500ms.
Execute	+++
Response	OK<CR>

5.3 Node Specific Information**5.3.1 AT+LONGADDR or AT+LA**

Description	Get the 64-bit IEEE address. (EUI address, long address) The IEEE address is a unique device address assigned during manufacturing. This address is unique to each physical device.
Execute	AT+LONGADDR?<CR>
Response	<IEEE address><CR> OK<CR>

5.3.2 AT+SHORTADDR or AT+SA

Description	Get the 16-bit Node ID. (network address, short address) The node ID of “0000” is reserved for the coordinator. All other devices receive a randomly generated address from the router or coordinator device that allows the join. This value can change if an address conflict is detected where two devices are found to have the same address or a device leaves the network and later joins.
Execute	AT+SHORTADDR?<CR>
Response	<node ID><CR> OK<CR>

5.3.3 AT+ADDRDISCOVERY or AT+AD

Description	Get the corresponding address of a node whose long or short address is known.	
Execute	AT+ADDRDISCOVERY=<IEEE><CR>	AT+ADDRDISCOVERY=<nodeID><CR>
Response	<node ID><CR> OK<CR>	<IEEE address><CR> OK<CR>

5.3.4 AT+OPCH or AT+OC

Description	Get the operating channel number used for transmitting and receiving between RF modules. Uses 802.15.4 channel numbers. A value of “0” means the device has not joined a PAN and is not operating on any channel.
Execute	AT+OPCH?<CR>
Response	<value><CR> OK<CR>

5.3.5 AT+OPPANID or AT+OI

Description	Get the operating 16-bit PAN ID. If PAN ID is set specific value not 0s, operating PAN ID will equal designated PAN ID. A value of "FFFF" means the device is not joined a network.
Execute	AT+OPPANID?<CR>
Response	<value><CR> OK<CR>

5.3.6 AT+OPEPID or AT+OE

Description	Get the operating 64-bit extended PAN ID. A value of "FFFFFFFFFFFFFFFF" means the device is not joined a network.
Execute	AT+OPEPID?<CR>
Response	<value><CR> OK<CR>

5.3.7 AT+VERSION or AT+VR

Description	Get firmware version of the module. The firmware version returns a form of "PTvx.x".
Execute	AT+VERSION?<CR>
Response	<value><CR> OK<CR>

5.3.8 AT+PRODUCTNAME or AT+PN

Description	Get the product name. It can be used to distinguish among different hardware platforms.
Execute	AT+PRODUCTNAME?<CR>
Response	<value><CR> OK<CR>

5.4 Network Specific Parameters**5.4.1 AT+CHMASK or AT+CM**

Description	Get/Set the channel mask to use. Bits set as 1 indicate that this particular channel can be used. Bits set as 0 indicate that this particular channel should not be used. For example, a channel mask value of 0x00000001 indicates that only channel 0 should be used. Valid channels range from 12 to 25 inclusive. (14 channels are available.) This translates to a channel mask value of "0x03FFF000".	
Execute	AT+CHMASK?<CR>	AT+CHMASK=<value><CR>
Response	<value><CR> OK<CR>	OK<CR> or ERROR<CR>
Default	03FFF000	

Range	00001000 - 03FFF000
-------	---------------------

5.4.2 AT+PANID or AT+PI

Description	Get/Set the 16-bit PAN ID. If it is set to 0s, the coordinator will select a random 16-bit hexadecimal number as PAN ID, and the router/end-device will join any existing network if it is allowed.	
Execute	AT+PANID?<CR>	AT+PANID=<value><CR>
Response	<value><CR> OK<CR>	OK<CR> or ERROR<CR>
Default	0000	
Range	0000 – FFFF	

5.4.3 AT+EPID or AT+EI

Description	Get/Set the 64-bit extended PAN ID. If the node is a coordinator and the EPID is set to 0s, it will take the rearranged IEEE address as random number.	
Execute	AT+EPID?<CR>	AT+EPID=<value><CR>
Response	<value><CR> OK<CR>	OK<CR> or ERROR<CR>
Default	0000000000000000	
Range	0000000000000000 - FFFFFFFFFFFFFFFF	

5.4.4 AT+GROUPID or AT+GI

Description	Get/Set the 16-bit Group ID. It is used for multicast data reception.	
Execute	AT+GROUPID?<CR>	AT+GROUPID=<value><CR>
Response	<value><CR> OK<CR>	OK<CR> or ERROR<CR>
Default	0000	
Range	0000 - FFFF	

5.4.5 AT+POWER or AT+PW

Description	Get/Set the TX power at which the RF module transmits conducted power.	
Execute	AT+POWER?<CR>	AT+POWER=<value><CR>
Response	<value><CR> OK<CR>	OK<CR> or ERROR<CR>
Default	3	
Range	-43 - 3	

5.4.6 AT+STACK or AT+ZS

Description	Get/Set the ZigBee stack profile value. This value must be set the same on all devices
-------------	--

	that should join the same network. (0: Network specific, 1: ZigBee, 2: ZigBee Pro)	
Execute	AT+STACK?<CR>	AT+STACK=<value><CR>
Response	<value><CR> OK<CR>	OK<CR> or ERROR<CR>
Default	0	
Range	0 - 2	

5.4.7 AT+NODENAME or AT+NN

Description	Get/Set the node name. It can be used to make a clear distinction role or functionality of local node from others.	
Execute	AT+NODENAME?<CR>	AT+NODENAME=<value><CR>
Response	<value><CR> OK<CR>	OK<CR> or ERROR<CR>
Default	ProBee-ZS	
Range	Up to 16 characters	

5.5 Network Formation and Join

5.5.1 AT+ASCAN or AT+AS

Description	Perform a scanning for existing network. It can take up to 5 seconds. (CAUTION: It is possible to cause a link error if a node is a parent of an end-device.)	
Execute	AT+ASCAN<CR>	AT+ASCAN=<channel mask><CR>
Response	<channel> <PAN ID> <EPID> <joinable> <stack profile> <i>List of the existing networks ...</i> OK<CR>	

5.5.2 AT+ESCAN or AT+ES

Description	Perform a scanning for energy level of all channels. It can take up to 5 seconds. (CAUTION: It is possible to cause a link error if a node is a parent of an end-device.)	
Execute	AT+ESCAN<CR>	AT+ESCAN=<channel mask><CR>
Response	<channel> <RSSI > <i>List of the RSSI for each channel ...</i> OK<CR>	

5.5.3 AT+DSCAN or AT+DS

Description	Perform a scanning for existing nodes in the current network. A coordinator or router can have children nodes and they are presented by "CLDn". It can be possible to place some conditions such as scan duration, node type and node name in order. The information of local node is presented by "*".	
Execute	AT+DSCAN<CR> or	

	AT+DSCAN=<scan duration><CR> or AT+DSCAN=<scan duration>,<node type><CR> or AT+DSCAN=<scan duration>,<node type>,<node name><CR>
Response	<node type> <IEEE address> <node ID> <version> <product name> <node name> <i>List of the existing nodes and information...</i> OK<CR>
Range	Scan duration: 1 – 10 Node type: 0 – 4 (Zero indicates all node types.)

5.5.4 AT+NODETYPE or AT+NT

Description	Get/Set the node type. (0: none, 1: coordinator, 2: router, 3: end-device, 4: sleepy end-device)	
Execute	AT+NODETYPE?<CR>	AT+NODETYPE=<value><CR>
Response	<value><CR> OK<CR>	OK<CR> or ERROR<CR>
Default	0	
Range	0 - 4	

5.5.5 AT+PERMIT or AT+PJ

Description	Permit other nodes to join the network. (0~254s, 255=continuance) An end-device cannot perform it.	
Execute	AT+PERMIT<CR>	AT+PERMIT=<value><CR>
Response	OK<CR>	
Range	0 - 255	

5.5.6 AT+LEAVE or AT+LV

Description	Leave the current network.	
Execute	AT+LEAVE<CR>	
Response	OK<CR>	

5.6 End-device

5.6.1 AT+SLEEP or AT+SM

Description	Enter the sleep mode immediately if the node is an end-device.	
Execute	AT+SLEEP<CR>	
Response	OK<CR>	

5.6.2 AT+PARENTLA or AT+PL

Description	Get the 64-bit IEEE address of the parent node.	
Execute	AT+PARENTLA?<CR>	

Response	<IEEE address><CR> OK<CR>
----------	------------------------------

5.6.3 AT+PARENTSA or AT+PS

Description	Get the 16-bit Node ID of the parent node.
Execute	AT+PARENTSA?<CR>
Response	<node ID><CR> OK<CR>

5.6.4 AT+CHILDTABLE or AT+CT

Description	Get the child table composed of the end-devices.
Execute	AT+CHILDTABLE?<CR>
Response	<node type> <IEEE address> <node ID> <i>List of the child nodes...</i> OK<CR>

5.7 Data Transmission and Reception

5.7.1 AT+DESTLA or AT+DL

Description	Get/Set the 64-bit destination IEEE address for unicast data transmission.	
Execute	AT+DESTLA?<CR>	AT+DESTLA=<value><CR>
Response	<value><CR> OK<CR>	OK<CR> or ERROR<CR>
Default	0000000000000000	
Range	0000000000000000 - FFFFFFFF	

5.7.2 AT+DESTGROUPID or AT+DG

Description	Get/Set the 16-bit destination Group ID for multicast data transmission.	
Execute	AT+DESTGROUPID?<CR>	AT+ DESTGROUPID=<value><CR>
Response	<value><CR> OK<CR>	OK<CR> or ERROR<CR>
Default	0000	
Range	0000 – FFFF	

5.7.3 AT+SINKINFO or AT+SI

Description	Get the long and short addresses of sink node. If there is no sink node in the network, the addresses will be "FFFFFFFFFFFFFFFF" and "FFFF".
Execute	AT+SINKINFO?<CR>
Response	<IEEE address>,<nodeID><CR> OK<CR>

5.7.4 AT+MAXPAYLOAD or AT+MP

Description	Get the maximum size of the payload that the Application Support sub-layer will accept. The size depends on the security level in use.
Execute	AT+MAXPAYLOAD?<CR>
Response	<value><CR> OK<CR>

5.7.5 AT+TRANSMITMODE or AT+TM

Description	Get/Set the data transmission mode. This mode is maintained after rebooting. (0: none, 1: unicast to destination long address, 2: multicast to destination group ID, 3: broadcast to all nodes, 4: unicast to sink node)	
Execute	AT+TRANSMITMODE?<CR>	AT+TRANSMITMODE=<value><CR>
Response	<value><CR> OK<CR>	OK<CR> or ERROR<CR>
Default	0	
Range	0 - 4	

5.7.6 AT+UNICAST or AT+UC

Description	Send unicast message to specific node using long or short address of remote node. Up to 90 bytes (or 72 bytes when security enabled) are sent to the node at once.	
Execute	AT+UNICAST=<IEEE>,<data><CR>	AT+UNICAST=<nodeID>,<data><CR>
Response	OK<CR>	

5.7.7 AT+MULTICAST or AT+MC

Description	Send multicast message to specific group. Every node belongs to a group after being booted up if it is designated a group ID.
Execute	AT+MULTICAST=<groupID>,<data><CR>
Response	OK<CR>

5.7.8 AT+BROADCAST or AT+BC

Description	Send broadcast message to the all nodes joining the network. Transmit range is determined by broadcast range (S35).
Execute	AT+BROADCAST=<data><CR>
Response	OK<CR>

5.7.9 AT+REMOTE or AT+RC

Description	Get/Set the configuration values of remote node using long or short address. AT+REMOTE<CR> shows the list of possible commands. It is possible to check the
-------------	---

	available remote command by "AT+REMOTE<CR>".	
Execute	AT+REMOTE=<addr>,<cmd>?<CR>	AT+REMOTE=<addr>,<cmd>=<value><CR>
Response	<value><CR> OK<CR>	OK<CR>

5.8 UART

5.8.1 AT+BAUDRATE or AT+UB

Description	Get/Set the serial port speed for communication between the module serial port and host.	
Execute	AT+BAUDRATE?<CR>	AT+BAUDRATE=<value><CR>
Response	<value><CR> OK<CR>	OK<CR> or ERROR<CR>
Default	9600	
Range	300 - 230400	

5.8.2 AT+DATABIT or AT+UD

Description	Get/Set the serial data bit setting on the module.	
Execute	AT+DATABIT?<CR>	AT+DATABIT=<value><CR>
Response	<value><CR> OK<CR>	OK<CR> or ERROR<CR>
Default	8	
Range	7 - 8	

5.8.3 AT+PARITY or AT+UP

Description	Get/Set the serial parity setting on the module.	
Execute	AT+PARITY?<CR>	AT+PARITY=<value><CR>
Response	<value><CR> OK<CR>	OK<CR> or ERROR<CR>
Default	0	
Range	0 - 2	

5.8.4 AT+STOPBIT or AT+US

Description	Get/Set the serial stop bit setting on the module.	
Execute	AT+STOPBIT?<CR>	AT+STOPBIT=<value><CR>
Response	<value><CR> OK<CR>	OK<CR> or ERROR<CR>
Default	1	
Range	1 - 2	

5.8.5 AT+FLOWCTRL or AT+UF

Description	Get/Set flow control status. (0: none, 1: software, 2: hardware flow control)	
Execute	AT+FLOWCTRL?<CR>	AT+FLOWCTRL=<value><CR>
Response	<value><CR> OK<CR>	OK<CR> or ERROR<CR>
Default	2	
Range	0 - 2	

5.9 Security

5.9.1 AT+SECURITY or AT+SE

Description	Get/Set the security status. (0: turning security off, 1: on) Every node must be under the same security level in the network.	
Execute	AT+SECURITY?<CR>	AT+SECURITY=<value><CR>
Response	<value><CR> OK<CR>	OK<CR> or ERROR<CR>
Default	0	
Range	0 - 1	

5.9.2 AT+LINKKEY or AT+LK

Description	Get/Set the 128-bit link key. (0 or 0s: generate 128-bit random number)	
Execute	AT+LINKKEY?<CR>	AT+LINKKEY=<value><CR>
Response	<value><CR> OK<CR>	OK<CR> or ERROR<CR>
Default	FFFFFFFFFFFFFFFFFFFFFFFFFFFFFFFF	

5.9.3 AT+NWKKEY or AT+NK

Description	Get/Set the 128-bit network key. (possible to set only for coordinator, 0 or 0s: generate random 128-bit number)	
Execute	AT+NWKKEY?<CR>	AT+NWKKEY=<value><CR>
Response	<value><CR> OK<CR>	OK<CR> or ERROR<CR>
Default	FFFFFFFFFFFFFFFFFFFFFFFFFFFFFFFF	

5.9.4 AT+UPDATEKEY or AT+UK

Description	Update the network key with a new generated key. (possible only for coordinator) It is applied after 30s later because sending too quickly may cause a sleepy end-device to miss the alternate encryption key and only get the switch key message, which means it will be unable to change to the new network key.	
Execute	AT+UPDATEKEY<CR>	

Response	OK<CR> or ERROR<CR>
----------	---------------------

5.10 Firmware Upload and Help

5.10.1 AT+BOOTLOAD or AT+BL

Description	Start bootloader to upload firmware. (blank: local, 1: passthru, 2: clone) The device leaves the AT command line and enters the bootloader menu for uploading new ProBee firmware. There's no restrict to use local upload but a sleepy end device cannot upload to remote node over the air. The current UART should be set 115200bps, 8 data bits, no parity, 1 stop bit and none flow control.	
Execute	AT+BOOTLOAD<CR>	AT+BOOTLOAD=<number>,<IEEE><CR>
Response	<i>Bootloader menu</i> ... Serial upload complete	Please start .ebl upload image ...<CR> or Start cloning ...<CR> <i>Bootloader menu</i> ... Bootload Complete!

5.10.2 AT+HELP or AT+HP

Description	Show all the available commands
Execute	AT+HELP<CR>
Response	Available AT Commands ... OK<CR>

6 AT Command Examples

6.1 Network configuration

6.1.1 Coordinator

```
AT+NODETYPE=1<CR>      # set node type (coordinator)
OK                       # Response
ATZ<CR>                 # Apply the change
OK                       # Response
```

6.1.2 Router

```
AT+NODETYPE=2<CR>      # set node type (router)
OK                       # Response
ATZ<CR>                 # Apply the change
OK                       # Response
```

6.1.3 End-device

```
AT+NODETYPE=3<CR>      # set node type (end-device)
OK                       # Response
ATZ<CR>                 # Apply the change
OK                       # Response
```

6.1.4 Sleepy End-device

```
AT+NODETYPE=4<CR>      # set node type (sleepy end-device)
OK                       # Response
ATZ<CR>                 # Apply the change
OK                       # Response
```

6.1.5 Specifying Network

```
AT+CHMASK=1000<CR>     # set 32-bit channel mask (ch: 12)
OK                       # Response
AT+PANID=0001 <CR>     # set 16-bit PAN ID (0001)
OK                       # Response
AT+EPID=000000000000001<CR> # set 64-bit extended PAN ID (000000000000001)
OK                       # Response
AT+ADDRDISCOVERY=1FEF<CR> # get 64-bit address using 16-bit short address
```

```

00019500002FDC15
OK # Response
AT+REMOTE=1FEF,AT+LONGADDR<CR> # get 64-bit address of remote node (1FEF)
00019500002FDC15
OK # Response
AT+DSCAN<CR> # get the information of other nodes in the network
ZC |00019500002FDC40|0000|PTv1.0|ZE10|ZE10_COM3
ZR |00019500002FDC15|1FEF|PTv1.0|ZE10|ZE10_COM4
CLD0|00019500002FDC17
CLD1|00019500002FDC14
ZED*|00019500002FDC17|7E34|PTv1.0|ZS10|ZS10_COM5
SED |00019500002FDC14|F5AC|PTv1.0|ZU10|ZU10_COM6
OK # Response

```

6.2 Data Transmission

6.2.1 Command Mode

```

# send unicast message(MSG01) to specific node using 64-bit long
address(0x00019500002FDC15)
AT+UNICAST=00019500002FDC15,MSG01<CR>
OK # Response
# send unicast message(MSG02) to specific node using 16-bit short
address(0x1FEF)
AT+UNICAST=1FEF,MSG02<CR>
OK # Response
# send multicast message(MSG03) to specific group(0001)
AT+MULTICAST=0001,MSG03<CR>
OK # Response
# send broadcast message(MSG04) to current network and the range is
determined by S35.
AT+BROADCAST=MSG04<CR>
OK # Response

```

6.2.2 Data Mode

```

ATD<CR> # enter the unicast mode using destination long address
OK # Response
MSG05+++ # send data(MSG05) and leave data mode
ATD0000<CR> # enter the unicast mode using 16-bit short address

```



```

OK                # Response
MSG06+++         # send data(MSG06) and leave data mode
ATD00019500002FDC40<CR> # enter the unicast mode using 64-bit long address
OK                # Response
MSG07+++         # send data(MSG07) and leave data mode
ATM<CR>          # enter the multicast mode using destination group ID
OK                # Response
MSG08+++         # send data(MSG08) and leave data mode
ATM0001<CR>      # enter the multicast mode using 16-bit group ID
OK                # Response
MSG09+++         # send data(MSG09) and leave data mode
ATB<CR>          # enter the broadcast mode
OK                # Response
MSG10+++         # send data(MSG10) and leave data mode
AT+TRANSMITMODE=1<CR> # set transmit mode
OK                # Response
ATZ<CR>          # Apply the change
OK                # Response
MSG11+++         # send data(MSG11) and leave data mode
ATO<CR>          # return to the current data mode

```

6.3 UART Settings

```

AT+BAUDRATE=115200<CR> # set baud rate (115,200bps)
OK                       # Response
AT+DATABIT=8<CR>       # set data bit (8bit)
OK                       # Response
AT+PARITY=0<CR>        # set parity (none)
OK                       # Response
AT+STOPBIT=1<CR>       # set stop bit (1bit)
OK                       # Response
AT+FLOWCTRL=2<CR>      # set flow control (hardware)
OK                       # Response
ATZ<CR>                 # Apply the change
OK                       # Response

```

6.4 Security

```

AT+SECURITY=1<CR>      # set security level (ON)
OK                      # Response
AT+LINKKEY=5A46...21<CR> # set the 128-bit trust center link key (5A46...21)
ATZ<CR>                # Apply the change
OK                      # Response
AT+NWKEY=0<CR>        # set the 128-bit network key (random key)
OK                      # Response
AT+UPDATEKEY<CR>     # update the changed network key
OK                      # Response

```

6.5 Firmware Upload

6.5.1 Local Node

```

# enter the bootloader menu for uploading firmware. Note that UART of local
node should be set to 115200-8-N-1-N.
AT+BOOTLOAD<CR>
Press Enter...

EM250 Bootloader v20 b09
1. upload ebl
2. run
3. ebl info
BL >                                # press "1" and upload ebl file by X-modem
begin upload
CCCCCCCCCCCC
Serial upload complete                # press "2" or reset after upload is done

```

6.5.2 Remote Node

```

# upload firmware to a remote node using 64-bit long address. Note that UART
of local node should be set to 115200-8-N-1-N.
AT+BOOTLOAD=1,00019500002FDC40<CR>
Please start .ebl upload image ...
CCCCCCCCCCCC                        # upload ebl file by X-modem
Bootload Complete!                   # succeed to upload

```

6.5.3 Clone

```
# clone the firmware of the local node to a remote node using 64-bit long  
address. Note that UART of local node should be set to 115200-8-N-1-N.
```

```
AT+BOOTLOAD=2,00019500002FDC40<CR>
```

```
Start cloning ...
```

```
Bootload Complete!           # succeed to upload
```

7 S-Registers

Register number	Descriptions
11	Display incoming message in command mode
12	Display command echo
13	Display command responses
14	Manage LED status
21	Inter character timeout
22	Permit joining timeout
23	TX power mode
31	Enable application-ACK
32	Transmission retries
33	Transmission timeout
34	Indirect transmission timeout
35	Broadcast range
36	Number of hops for multicast/broadcast
37	Number of hops of nonmembers for multicast
38	Receive local message for multicast/broadcast
39	Receive message by own data mode
51	Poll timeout for a parent node
52	Poll period for a sleepy node
53	Sleep duration
54	Standby timeout
55	Rejoin timeout
56	Poll period for a sleepy node
61	Sink advertise period
62	Many to one route request period

7.1 Display Options

7.1.1 S11

Description	Get/Set the display mode. It determines to display incoming message in command mode	
Execute	ATS11?<CR>	ATS11=<value><CR>
Response	<value><CR> OK<CR>	OK<CR>
Default	0	
Range	0 - 1	

7.1.2 S12

Description	Get/Set the command echo mode.	
Execute	ATS12?<CR>	ATS12=<value><CR>
Response	<value><CR> OK<CR>	OK<CR>
Default	1	
Range	0 – 1	

7.1.3 S13

Description	Get/Set the command responses mode.	
Execute	ATS13?<CR>	ATS13=<value><CR>
Response	<value><CR> OK<CR>	OK<CR>
Default	1	
Range	0 - 1	

7.1.4 S14

Description	Get/Set the LED mode. It causes the LED operation of ZS10 0: LEDs are always OFF regardless of configuration or status. 1: LEDs are OFF when the node is under sleep status. 2: LEDs always operate by the case.	
Execute	ATS14?<CR>	ATS14=<value><CR>
Response	<value><CR> OK<CR>	OK<CR>
Default	1	
Range	0 - 2	

7.2 Network Settings**7.2.1 S21**

Description	Get/Set the inter character timeout in milliseconds. It determines to send data packet after this time.	
Execute	ATS21?<CR>	ATS21=<value><CR>
Response	<value><CR> OK<CR>	OK<CR>
Default	100	
Range	0 - 10000	

7.2.2 S22

Description	Get/Set the timeout to permit joining. It determines the time in seconds that the device will allow other devices to join to it when it starts network but an end-device cannot perform it. If set to 255, the device will always permit joining.	
Execute	ATS22?<CR>	ATS22=<value><CR>
Response	<value><CR> OK<CR>	OK<CR>
Default	60	
Range	0 - 255	

7.2.3 S23

Description	Get/Set the power boost mode of the adapter. If enabled, boost mode improves sensitivity by 1dB and increases output power by 2dB, improving the link margin and range.	
Execute	ATS23?<CR>	ATS23=<value><CR>
Response	<value><CR> OK<CR>	OK<CR>
Default	0	
Range	0 – 1	

7.3 Data Transmissions**7.3.1 S31**

Description	Get/Set the application-ACK mode. If it is enabled, a node retransmits data packet when it is failed to send. A node sends next packet after receiving ACK from receiver node. This value must be set the same on the source and destination node for data transmission.	
Execute	ATS31?<CR>	ATS31=<value><CR>
Response	<value><CR> OK<CR>	OK<CR>
Default	1	
Range	0 - 1	

7.3.2 S32

Description	Get/Set the transmission retries. If application-ACK is enabled, a sender tries to retransmit up to this value.	
Execute	ATS32?<CR>	ATS32=<value><CR>
Response	<value><CR> OK<CR>	OK<CR>
Default	5	

Range	0 – 99
-------	--------

7.3.3 S33

Description	Get/Set the transmission timeout in milliseconds. If application-ACK is enabled, a sender retransmits data packet after this time.	
Execute	ATS33?<CR>	ATS33=<value><CR>
Response	<value><CR> OK<CR>	OK<CR>
Default	500	
Range	0 – 10000	

7.3.4 S34

Description	Get/Set the indirect transmission timeout in milliseconds. It is the maximum amount of time that the MAC will hold a message for indirect transmission to a child.	
Execute	ATS34?<CR>	ATS34=<value><CR>
Response	<value><CR> OK<CR>	OK<CR>
Default	7680	
Range	0 – 30000	

7.3.5 S35

Description	<p>Get/Set the broadcast range. ZigBee specifies three different broadcast addresses that reach different collections of nodes. Broadcasts are normally sent only to routers. Broadcasts can also be forwarded to end devices, either all of them or only those that do not sleep. Broadcasting to end devices is both significantly more resource-intensive and significantly less reliable than broadcasting to routers.</p> <p>0: send to all routers 1: send to all non-sleepy nodes 2: send to all nodes in the network</p>	
Execute	ATS35?<CR>	ATS35=<value><CR>
Response	<value><CR> OK<CR>	OK<CR>
Default	2	
Range	0 – 2	

7.3.6 S36

Description	Get/Set the maximum number of hops the message will be relayed. The message will be delivered to all nodes within this number of hops of the sender. A value of zero is
-------------	---

	converted to maximum value(30). It is used to multicast/broadcast.	
Execute	ATS36?<CR>	ATS36=<value><CR>
Response	<value><CR> OK<CR>	OK<CR>
Default	0	
Range	0 – 10	

7.3.7 S37

Description	Get/Set the number of hops that the message will be forwarded by devices that are not members of the group. A value of zero, 7 or greater is treated as infinite. There is no longer a separate limited multicast API call.	
Execute	ATS37?<CR>	ATS37=<value><CR>
Response	<value><CR> OK<CR>	OK<CR>
Default	0	
Range	0 – 7	

7.3.8 S38

Description	Get/Set the receive message mode. If it is enabled, a local node will receive multicast or broadcast messages from itself.	
Execute	ATS38?<CR>	ATS38=<value><CR>
Response	<value><CR> OK<CR>	OK<CR>
Default	0	
Range	0 – 1	

7.3.9 S39

Description	If S39 is enabled, a local node will only receive the same type of messages with its transmit mode. For example, if local node's transmission mode is broadcast mode (AT+TM=3), it will only receive broadcast messages.	
Execute	ATS39?<CR>	ATS39 =<value><CR>
Response	<value><CR> OK<CR>	OK<CR>
Default	0	
Range	0 - 1	

7.4 End Device

7.4.1 S51

Description	Get/Set the poll timeout for a parent node in seconds. If an end device or a sleepy end
-------------	---

	device does not send a poll request to its parent coordinator or router within the poll timeout, the end device is removed from the child table.	
Execute	ATS51?<CR>	ATS51=<value><CR>
Response	<value><CR> OK<CR>	OK<CR>
Default	60	
Range	0 – 4177920	

7.4.2 S52

Description	Get/Set the sleepy end device poll period in milliseconds. Adaptive polling may allow the sleepy end device to poll more rapidly for a short time when receiving RF data.	
Execute	ATS52?<CR>	ATS52=<value><CR>
Response	<value><CR> OK<CR>	OK<CR>
Default	100	
Range	0 - 10000	

7.4.3 S53

Description	Get/Set the sleep duration in quarter seconds. An end-device sleeps at this time and turns off radio every sleep cycle. If a node sleeps over poll timeout of parent node, the device will be removed from the child table.	
Execute	ATS53?<CR>	ATS53=<value><CR>
Response	<value><CR> OK<CR>	OK<CR>
Default	8	
Range	0 – 16711680	

7.4.4 S54

Description	Get/Set the standby timeout in seconds. When an end-device wakes up and polls with the parent node, the node will wait for another data from the ZigBee network or from the serial port for S54 before it goes to sleep mode again. If any serial or RF data is sent or received, the timer will reset and wait for next again.	
Execute	ATS54?<CR>	ATS54=<value><CR>
Response	<value><CR> OK<CR>	OK<CR>
Default	5	
Range	0 – 10000	

7.4.5 S55

Description	Get/Set the rejoin timeout. If it is enabled, an end-device tries to rejoin the current network when contact with the network has been lost for setting value in seconds. The most common usage case is when an end device can no longer communicate with its parent and wishes to find a new one.	
Execute	ATS55?<CR>	ATS55=<value><CR>
Response	<value><CR> OK<CR>	OK<CR>
Default	10	
Range	0 – 10000	

7.4.6 S56

Description	Get/Set the end device poll period in seconds. Adaptive polling may allow the end device to poll more rapidly for a short time when receiving RF data.	
Execute	ATS56?<CR>	ATS56=<value><CR>
Response	<value><CR> OK<CR>	OK<CR>
Default	5	
Range	0 – 10000	

7.5 Sink**7.5.1 S61**

Description	Get/Set the sink node and the sink advertise period in seconds. When a node is defined as a sink, it can multicast its address to the rest of the network. If set to 0, sink advertise is disabled.	
Execute	ATS61?<CR>	ATS61=<value><CR>
Response	<value><CR> OK<CR>	OK<CR>
Default	0	
Range	0 – 10000	

7.5.2 S62

Description	Get/Set the period to send Many-to-One Route Request. Many-to-One Route Request (MTOR) creates routes from every node in the network back to this node. It is useful when this node acts as a sink node.	
Execute	ATS62?<CR>	ATS62=<value><CR>
Response	<value><CR> OK<CR>	OK<CR>
Default	0	

Range	0 – 10000
-------	-----------

8 Mechanical Drawings

8.1 ProBee-ZS10 mechanical drawing (mm)

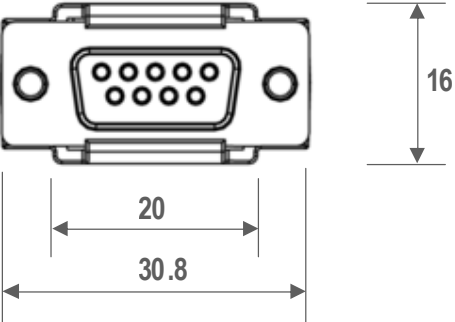
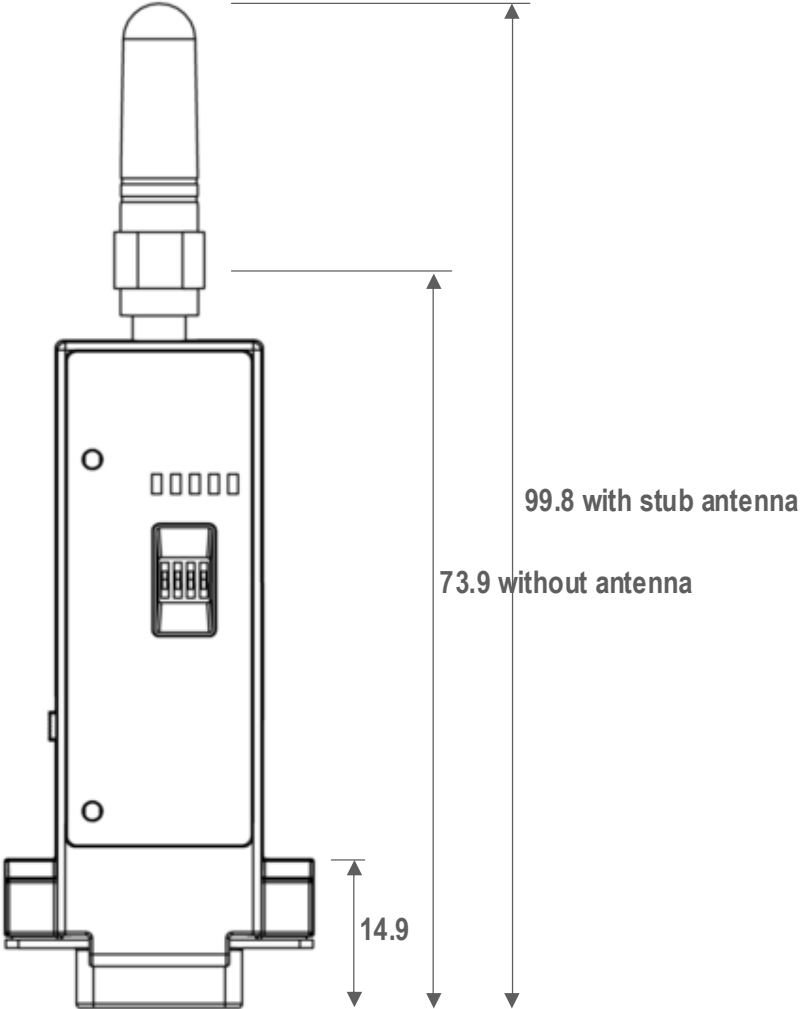

8.2 Battery pack mechanical drawing (mm)

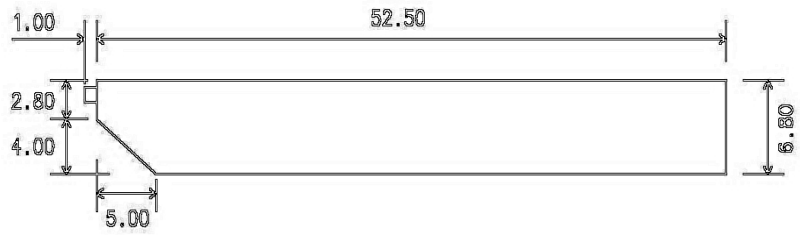
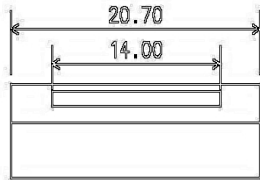

Standard Battery Pack

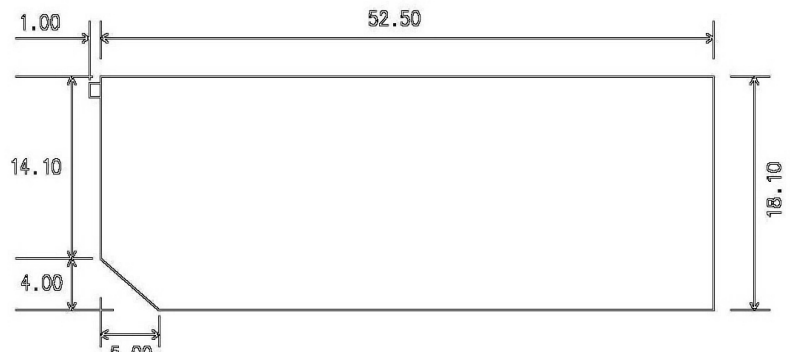
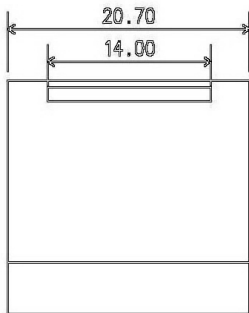

Extended Battery Pack

9 Warranty

9.1 GENERAL WARRANTY POLICY

Sena Technologies, Inc. (hereinafter referred to as SENA) warrants that the Product shall conform to and perform in accordance with published technical specifications and the accompanying written materials, and shall be free of defects in materials and workmanship, for the period of time herein indicated, such warranty period commencing upon receipt of the Product.

This warranty is limited to the repair and/or replacement, at SENA's discretion, of defective or non-conforming Product, and SENA shall not be responsible for the failure of the Product to perform specified functions, or any other non-conformance caused by or attributable to: (a) any misapplication or misuse of the Product; (b) failure of Customer to adhere to any of SENA's specifications or instructions; (c) neglect of, abuse of, or accident to, the Product; or (d) any associated or complementary equipment or software not furnished by SENA.

Limited warranty service may be obtained by delivering the Product to SENA or to the international distributor it was purchased through and providing proof of purchase or receipt date. Customer agrees to insure the Product or assume the risk of loss or damage in transit, to prepay shipping charges to SENA, and to use the original shipping container or equivalent.

9.2 LIMITATION OF LIABILITY

EXCEPT AS EXPRESSLY PROVIDED HEREIN, SENA MAKES NO WARRANTY OF ANY KIND, EXPRESSED OR IMPLIED, WITH RESPECT TO ANY EQUIPMENT, PARTS OR SERVICES PROVIDED PURSUANT TO THIS AGREEMENT, INCLUDING BUT NOT LIMITED TO THE IMPLIED WARRANTIES OF MERCHANTABILITY AND FITNESS FOR A PARTICULAR PURPOSE. NEITHER SENA NOR ITS DEALER SHALL BE LIABLE FOR ANY OTHER DAMAGES, INCLUDING BUT NOT LIMITED TO DIRECT, INDIRECT, INCIDENTAL, SPECIAL OR CONSEQUENTIAL DAMAGES, WHETHER IN AN ACTION IN CONTRACT OR TORT (INCLUDING NEGLIGENCE AND STRICT LIABILITY), SUCH AS, BUT NOT LIMITED TO, LOSS OF ANTICIPATED PROFITS OR BENEFITS RESULTING FROM, OR ARISING OUT OF, OR IN CONNECTION WITH THE USE OF FURNISHING OF EQUIPMENT, PARTS OR SERVICES HEREUNDER OR THE PERFORMANCE, USE OR INABILITY TO USE THE SAME, EVEN IF SENA OR ITS DEALER HAS BEEN ADVISED OF THE POSSIBILITY OF SUCH DAMAGES. IN NO EVENT WILL SENA OR ITS DEALERS TOTAL LIABILITY EXCEED THE PRICE PAID FOR THE PRODUCT.

9.3 HARDWARE PRODUCT WARRANTY DETAILS

WARRANTY PERIOD: SENA warranties embedded hardware Product for a period of one (1) year, and

external hardware Product for a period of three (3) or five (5) years according to the Product type.

WARRANTY PROCEDURE: Upon return of the hardware Product SENA will, at its option, repair or replace Product at no additional charge, freight prepaid, except as set forth below. Repair parts and replacement Product will be furnished on an exchange basis and will be either reconditioned or new. All replaced Product and parts become the property of SENA. If SENA determines that the Product is not under warranty, it will, at the Customers option, repair the Product using current SENA standard rates for parts and labor, and return the Product at no charge in or out of warranty.

WARRANTY EXCLUSIONS: Damages caused by

- Accidents, falls, objects striking the SENA product,
- Operating the Product in environments that exceed SENA's temperature and humidity specifications,
- Power fluctuations, high voltage discharges,
- Improper grounding, incorrect cabling,
- Misuse, negligence by the customer or any other third party,
- Failure to install or operate the product (s) in accordance to their SENA User Manual,
- Failure caused by improper or inadequate maintenance by the customer or any other third party,
- Floods, lightning, earthquakes,
- Water spills,
- Replacement of parts due to normal wear and tear,
- Hardware has been altered in any way,
- Product that has been exposed to repair attempts by a third party without SENA's written consent,
- Hardware hosting modified SENA Software, or non-SENA Software, unless modifications have been approved by Sena.
- Battery component capacity degradation due to usage, aging, and with some chemistry, lack of maintenance.

9.4 SOFTWARE PRODUCT WARRANTY DETAILS

WARRANTY PERIOD: SENA warranties software Product for a period of one (1) year.

WARRANTY COVERAGE: SENA warranty will be limited to providing a software bug fix or a software patch, at a reasonable time after the user notifies SENA of software non-conformance.

9.5 THIRD-PARTY SOFTWARE PRODUCT WARRANTY DETAILS

The warranty policy of the third-party software is conformed to the policy of the corresponding vendor.

10 Regulatory Information

10.1 FCC

FCC Rule: Part 15 Subpart C Section 15.247

FCCID: S7AZBLINXZS10

FCC Compliance Statement

This device complies with part 15 of the FCC Rules. Operation is subject to the following two conditions:

- (1) This device may not cause harmful interference, and
- (2) This device must accept any interference received,
Including interference that may cause undesired operation

Information to User

This equipment has been tested and found to comply with limits for a Class B digital device, Pursuant to Part 15 of the FCC Rules. These limits are designed to provide reasonable protection against harmful interference in a residential installation.

This equipment generate, uses and can radiate radio frequency energy and, if not installed and used in accordance with the instructions, may cause harmful interference to radio communications.

However, there is no guarantee that interference will not occur in a particular installation. If this equipment does cause harmful interference to radio or television reception, which can be determined by turning the equipment off and on, the user is encouraged to try to correct the interference by on or more of the following measures:

- Reorient or relocate the receiving antenna.
- Increase the separation between the equipment and receiver-Connect the equipment into an outlet a circuit different form that to which the receiver is connected.
- Consult the dealer or an experienced radio/TV technician for help.

RF Exposure Statement

The equipment complies with FCC RF radiation exposure limits set forth for an uncontrolled environment. This device and its antenna must not be co-located or operation in conjunction with any other antenna or transmitter.

Do not

Any changes or modifications to the equipment not expressly approved by the party responsible for compliance could void user's authority to operate the equipment.

10.2 CE

CE1177(!)

We, Sena Technologies, Inc., declare that the product(s):

- ProBee-ZS10 ZigBee Serial Adapter

to which this declaration relates is in conformity with the following standard(s) or other normative document(s)

- EN 60950-1
- ETSI EN 301 489-1
- ETSI EN 301 489-17
- ETSI EN 300 328

Following the provisions of

- EMC DIRECTIVE 1999/5/EC

10.3 TELECOM

Technical Regulations for Specified Radio Equipment Article 2, Section 1 (19)
Certification No: 010WWBT31

10.4 KCC

Type Registration

Certification No: SNA-ZBlinx-ZS10

Basic Model Number: ZBlinx-ZS10

10.5 ZigBee Alliance

Manufacturer Specific

ZIG10006PRV38490-24

11 RF Information

Radio Frequency Range

2.410~2.475GHz

Number of Frequency Channel

14 channels

Transmission Method

DSSS (Direct Sequence Spread Spectrum)

Modulation Method

O-QPSK (Offset Quadrature Phase Shift Keying)

Radio Output Power

+18dBm

Receiving Sensitivity

-102dBm

Power Supply

DC3.3V