

New as of:

02.2009

# CEREC 3

## Operating Instructions

**English**

This product is covered by one or more of the following US patents:

- US5661519
- US6485305
- US6885464
- US7010150
- US6427352
- US645629
- US6394880
- US6614538
- US6953883
- US6702649
- US7367801
- US7178731
- US7163443

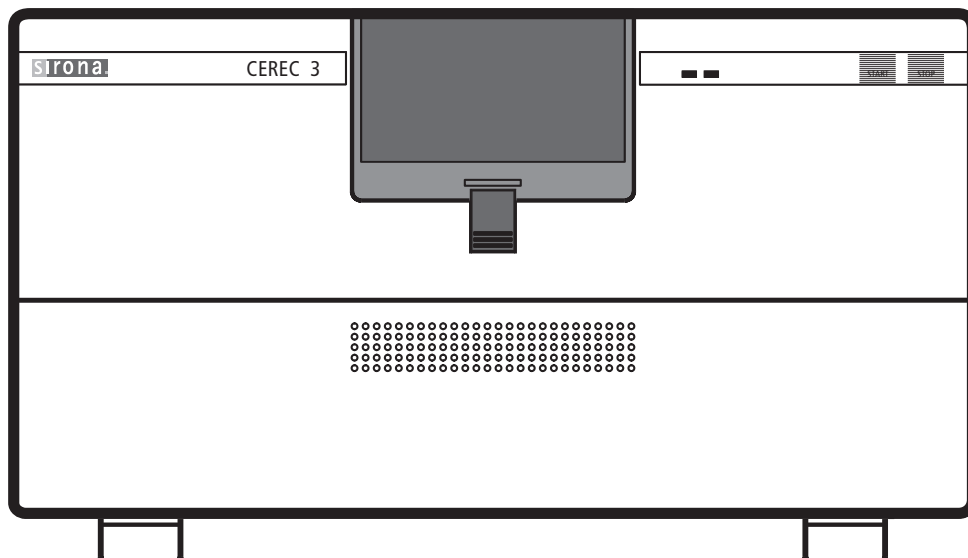



# Contents

<b>1</b>	<b>Dear Customer .....</b>	<b>6</b>
<b>2</b>	<b>General information .....</b>	<b>7</b>
2.1	Structure of the documents .....	7
2.1.1	Legend .....	7
2.2	Note PC / Acquisition Unit .....	8
2.3	Warranty .....	8
2.4	Disposal .....	8
2.4.1	Additional note on disposal .....	8
<b>3</b>	<b>General description.....</b>	<b>9</b>
3.1	Certification .....	9
3.2	Intended use .....	9
<b>4</b>	<b>Safety.....</b>	<b>10</b>
4.1	Basic safety information .....	10
4.1.1	Prerequisites .....	10
4.1.2	Maintenance and repair.....	10
4.1.3	Modifications of the unit.....	10
4.1.4	Accessories .....	10
4.2	Milling unit .....	11
4.2.1	Safety information for the scanner (option) .....	11
4.2.2	Milling chamber door open during the milling operation 11	
4.3	Wireless phone interference with equipment ....	12
4.4	Disturbance of data transmission via radio module (option) .....	12
<b>5</b>	<b>Installation and startup .....</b>	<b>13</b>
5.1	Transport and unpacking .....	13
5.2	Disposal of packaging materials .....	13
5.3	Installation site .....	13
5.3.1	Only with integrated scanner (option).....	14
5.4	Initial startup .....	14
5.4.1	Controls and functional elements .....	14
5.4.2	Information on the START/STOP button.....	15
5.4.3	Description of LEDs.....	16
5.4.4	Filling the water tank .....	16
5.4.5	Installation .....	17
5.4.6	Switching the units on .....	20

5.5	Repacking .....	25
5.6	Scope of supply .....	25
5.7	Storage .....	25
<b>6</b>	<b>Operation .....</b>	<b>26</b>
6.1	Setting the acquisition unit to scanner (onl with integrated scanner) .....	26
6.2	Calibrating the unit .....	26
6.2.1	Calibrating the milling unit .....	27
6.2.2	Calibrating the scanner (only with integrated scanner) 31	
6.3	Starting the scanning process (only with integrated scanner) .....	32
6.4	Start the milling process .....	34
6.5	Preparing optical scanning (only with integrated scanner) .....	36
6.5.1	Information on preparing models for implants...	36
6.5.2	Creating a model .....	37
6.5.3	Preparing for scanning of the veneer model .....	38
<b>7</b>	<b>Maintenance.....</b>	<b>39</b>
7.1	Changing the water .....	39
7.1.1	General information.....	39
7.1.2	Changing the water .....	40
7.2	Milling instruments .....	42
7.2.1	Overview of materials and milling instruments ..	42
7.2.2	Changing milling instruments (burs).....	43
7.3	Care and cleaning agents .....	45
7.4	Cleaning surfaces .....	45
7.4.1	Disinfecting.....	45
7.4.2	Protection against medicaments .....	45
7.4.3	Cleaning .....	45
7.5	Replacing the main fuses .....	46
7.6	Removing water from the unit .....	47
<b>8</b>	<b>Technical description .....</b>	<b>48</b>
8.1	System requirements .....	48
8.2	Milling unit .....	48
8.2.1	Technical data .....	49
8.2.2	Scanner for optical measurement of the preparation (option) .....	50
8.2.3	Controller board:.....	50
8.3	Radio module (optional) .....	51

<b>9</b>	<b>Appendix .....</b>	<b>52</b>
9.1	Procedure in case of problems downloading via the DECT radio interface .....	52
9.2	Procedure in case of problems downloading via the Höft&Wessel radio interface .....	52
9.3	Procedure in case of problems downloading with the supplied serial cable .....	53
9.4	Overview of old and new designations for milling instruments .....	53
	Index.....	54

# 1 Dear Customer

Thank you for purchasing your CEREC 3<sup>®</sup> from Sirona.

This device enables you to produce dental restorations, e.g. from ceramic material with a natural appearance (**CE**ramic **RE**Construction).

Improper use and handling can create hazards and cause damage. Please read and follow these operating instructions carefully and always keep them within easy reach.

To prevent personal injury or material damage it is important to observe all safety information.

To safeguard your warranty claims, please complete the attached **Installation Report / Warranty Passport** when the system is handed over and send it to the indicated fax number.

Your  
CEREC 3 Team

## 2 General information



### **CAUTION: Be sure to observe all warnings!**

Please observe the warning and safety information provided to prevent personal injury and material damage. Any such information is highlighted by a signal word, i.e. WARNING, CAUTION or NOTE.

Please read these operating instructions completely and follow them exactly. always keep them within easy reach.

### 2.1 Structure of the documents

#### Structure of the documents

The symbols and character formats used in the present manual have the following meaning:



#### **WARNING:**

Identifies warnings where a medium risk of injury to persons exists if they are not observed.



#### **CAUTION:**

Identifies safety information where the following hazards exist if they are not observed: Slight risk of injury to persons, risk of property damage or damage to the product.



#### **NOTE: Assistance**

Identifies additional information, hints and tips.

<ul style="list-style-type: none"> <li>✓ Prerequisite</li> <li>➤ Action</li> <li>or</li> <li>➤ 1., 2., ...</li> <li>↵ Result</li> </ul>	Requests you to do something.
See chapter on "General information". [ 7 ]	Identifies a reference to another text passage.
▪ List	Identifies a list.
"Text between quotation marks"	Identifies commands, menu items or quotations.

#### 2.1.1 Legend

Year of manufacture

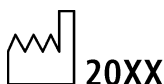

## 2.2 Note PC / Acquisition Unit

When a PC is described in this document, this refers to a PC for the acquisition unit (if present). The PC is represented symbolically.

Please observe our recommendations for PC configuration (see System requirements [48]).

## 2.3 Warranty

To safeguard your warranty claims, please complete the attached Installation Report / Warranty Passport when the system is handed over. Then fax it to the specified fax no.

## 2.4 Disposal

Any disposal of this product must comply with the relevant national regulations. Please observe the regulations applicable in your country.

Within the European Economic Community, Council Directive 2002/96/EC (WEEE) requires environmentally sound recycling/disposal of electrical and electronic devices.



Your product is marked with the adjacent symbol. Disposal of your product with domestic refuse is not compatible with the objectives of environmentally sound recycling/disposal. The black bar underneath the "garbage can" symbol means that it was put into circulation after Aug. 13, 2005 (see EN 50419:2005).

Please note that this product is subject to Council Directive 2002/96/EC (WEEE) and the applicable national law of your country and must be recycled or disposed of in an environmentally sound manner.

Please contact your dealer if final disposal of your product is required.

### 2.4.1 Additional note on disposal

The system mainboard contains a lithium battery.



## 3 General description

### 3.1 Certification

#### CE mark



This product bears the CE mark in accordance with the provisions of Council Directive 73/23/EEC<sup>1</sup> of February 19, 1973 concerning electrical equipment designed for use within certain voltage limits.



#### **CAUTION: CE mark for connected products**

Further products which are connected to the milling unit must also bear the CE mark. These products must be tested according to the applicable standards.

Examples of CE mark for connected products:

- EN 60601-1:1990 + A1:1993 + A2:1995 based on IEC 60601-1
- EN 60950:1992 + A1: 1993 + A2: 1993 + A3: 1995 + A4: 1997 based on IEC 60950
- UL 60950 third edition 2000

### 3.2 Intended use

This unit produces computer-aided dental restorations, e.g. from natural-appearing ceramic material. It must not be used for any other purpose.

The intended use also includes observance of the present operating instructions and the relevant maintenance instructions.



#### **NOTE:**

If the instructions for operation of the system described in this document are not observed, the intended safety of the user may be impaired.

1. Amended by Council Directive 93/68/EEC.

## 4 Safety

### 4.1 Basic safety information

#### 4.1.1 Prerequisites



**NOTE: Important info on Building installation**

The building installation must be performed by a qualified expert in compliance with the national regulations. DIN VDE 0100-710 applies in Germany.



**NOTE: Restrictions regarding installation site**

The system is not intended for operation in areas subject to explosion hazards.



**ATTENTION: Do not damage the unit!**

The unit can be damaged if opened improperly.  
It is expressly prohibited to open the unit with tools!

#### 4.1.2 Maintenance and repair

As manufacturers of dental instruments and laboratory equipment, we can assume responsibility for the safety properties of the unit only if the following points are observed:

- The maintenance and repair of this unit may be performed only by Sirona or by agencies authorized by Sirona.
- Components which have failed and influence the safety of the unit must be replaced with original (OEM) spare parts.

Please request a certificate whenever you have such work performed. It should include:

- The type and scope of work.
- Any changes made in the rated parameters or working range.
- Date, name of company and signature.

#### 4.1.3 Modifications of the unit

Modifications to this unit which may affect the safety of the operator, patients or third parties are prohibited by law!

#### 4.1.4 Accessories

To ensure product safety, this product may be operated only with original Sirona accessories or third-party accessories expressly approved by Sirona. The user assumes the risk of using non-approved accessories.

## 4.2 Milling unit

### 4.2.1 Safety information for the scanner (option)

This milling unit complies with Laser Class 1. It poses no hazard whatsoever.

The Laser itself is a Class 2 laser device and can injure a person's skin or eyes. It is located on the left motor mount in the scanner.



#### **WARNING: Laser radiation hazard**

Gazing into the beam for longer periods of time can damage a person's vision.

Never look directly into the laser beam and do not use any optical devices for this purpose.

The laser beam emerges at right angles to the window of the scanner.

#### **CAUTION:**

Use of controls or adjustments or performance of procedures other than those specified herein may result in hazardous radiation exposure.

#### **NOTE: Laser beam**

Power: < 1mW

Wavelength: 670 nm

Aperture angle: > 10 mrad

#### **WARNING:**

Check the scanner for visible signs of damage before each scanning operation.

Check the door of the milling chamber for visible signs of damage before each milling operation.

#### **WARNING: Installing and removing the scanner**

Only service engineers may install or remove the scanner.

### 4.2.2 Milling chamber door open during the milling operation

#### **WARNING: Milling instruments that continue to run**

When the milling chamber door is opened during the milling operation, the milling instruments could continue to run for a short time.

- Be careful not to touch the milling instruments with your hand or any other object during this time.
- Avoid opening the milling chamber door while the milling unit is in operation.
- Before you open the milling chamber door, end any actions that are running by selecting the "Stop" key on the milling unit or in the application software.

### 4.3 Wireless phone interference with equipment

The use of mobile wireless phones in practice or hospital environments must be prohibited to ensure safe operation of the unit.

### 4.4 Disturbance of data transmission via radio module (option)

#### DECT radio module

Data transmission may be adversely affected in the following cases:

- if more than 6 pairs of radio interfaces are used in one area
- if an E-net mobile phone is used near the radio interface

#### Höft&Wessel radio module

Data transmission may be adversely affected if more than 8 pairs of radio interfaces are used in one area.

If the radio module is operated in Norway, please note that it must not be operated within a radius of 20 km around Ny-Alesund.

## 5 Installation and startup

### 5.1 Transport and unpacking

All products from Sirona are carefully checked prior to shipment. Please perform the incoming inspection immediately after delivery.

1. Check the delivery note to ensure that the consignment is complete.
2. Check whether the product shows any visible signs of damage.



#### **NOTE: Damage during transport**

If the product was damaged during transport, please contact your carrying agent.

If return shipment is required, please use the original packaging for shipment.

Before every transport, the unit must be drained prior to shipment (if it has been operated). See "Removing water from the unit" [47]

### 5.2 Disposal of packaging materials

The packaging must be disposed of in compliance with the relevant national regulations. Please observe the regulations applicable in your country.

### 5.3 Installation site



#### **WARNING: Install out of the reach of patients!**

Do not install or operate the milling unit in the vicinity of the patient (place it at least 1.5 m away from the patient).

The milling unit requires a level Approx. footprint: 480 x 440 mm (W x D). The height of the milling unit is 250 mm:

Install the milling unit in such a way that it is not difficult to operate the main switch.

Make sure that the ventilation slots underneath and at the back of the unit remain unobstructed. The distance between the rear side of the unit and the room wall must be at least 10 cm.

Note that the unit weighs 30 kg!

The unit must not be installed at sites with a high level of humidity or dust!



#### **CAUTION: Installation in a cabinet**

If the unit is installed in a cabinet, you must provide for adequate heat exchange.

The ambient temperature surrounding the unit must be between 5°C and 40°C.

### 5.3.1 Only with integrated scanner (option)

**⚠ CAUTION: Impairment of the scanned result due to sudden incidence of light.**

A sudden, strong incidence of light may falsify the scanned result.

Set the unit up so that the milling chamber is not located directly in the beam path of an extreme light source and is not exposed to direct sunlight.

## 5.4 Initial startup

**⚠ CAUTION: Important information on initial startup**

Observe the software installation instructions!

### 5.4.1 Controls and functional elements

Overview of the front panel

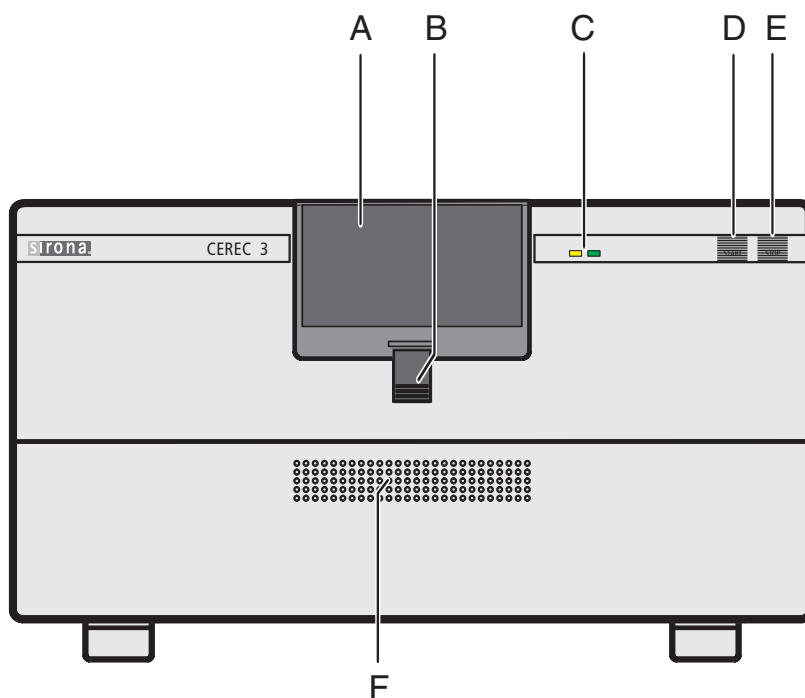

Fig. 5-1 Front view of CEREC 3 milling unit

- |   |                                   |   |              |
|---|-----------------------------------|---|--------------|
| A | Milling chamber                   | D | START button |
| B | Catch for<br>Milling chamber door | E | STOP button  |
| C | LEDs                              | F | Front flap   |

**Ports on the back side**

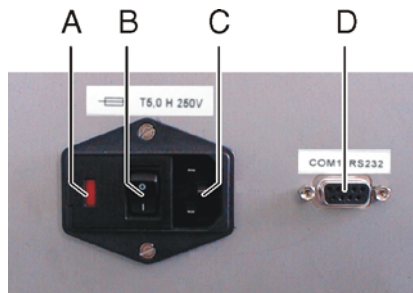

Fig. 5-2 Rear side

- A Fuse cover
- B Main switch  
I = ON, 0 = OFF
- C Power connection
- D Serial port

**5.4.2 Information on the START/STOP button**

**START button**



Fig. 5-3 START button

A	Button on the screen	B	START button on the milling unit
---	----------------------	---	----------------------------------

You can confirm all dialog boxes either by clicking the SW button Start on the screen or by pressing the HW START button on the milling unit.

**STOP button**



Fig. 5-4 STOP button

A	Button on the screen	B	STOP button on the milling unit
---	----------------------	---	---------------------------------

A machining operation can be interrupted either by clicking on the SW Stop button on the screen or by pressing the HW STOP button on the milling unit.

### 5.4.3 Description of LEDs



**NOTE: Table also available as label**

The following table is also available as a label affixed to the inside of the front flap.

It describes the system states indicated by the LEDs.

Green LED	Yellow LED	Description	Actions required
ON	OFF	Ready for operation	-
ON	Intermittent fast flashing	Milling chamber door open	Close milling chamber door
ON	Intermittent slow flashing	Request to insert part	Insert part, close milling chamber door, press START
ON	Slow flashing	Just before end of milling/scanning	Wait
ON	ON	Error, STOP button pressed	Observe message to PC/acquisition unit

### 5.4.4 Filling the water tank

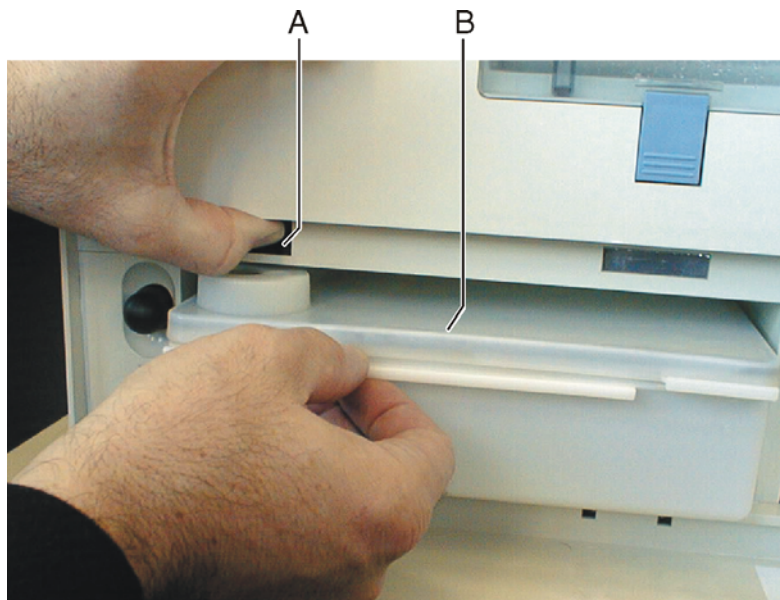

Fig. 5-5 2 liter water tank

A	Tank catch	B	Water tank
---	------------	---	------------

- ✓ The water tank is drained, see "Removing water from the unit" [47].





1. Open the flap on the front panel of the unit. To open the front flap, pull it on both sides.
2. Press the tank catch upward and carefully pull out the water tank toward the front of the unit.
3. Open the water tank.
4. Take the accessories out of the tank and remove the transport lock of the water filter.

**⚠ CAUTION: Damage to surfaces!**

DENTATEC milling additive etches plastic surfaces in undiluted form and can cause discoloration.

- Do not place DENTATEC on the unit.
- Do not spill DENTATEC.

5. Add approx. 50 ml\* of DENTATEC to the tank.  
or
  - \* With the materials IVOCLAR VIVADENT IPS Empress CAD and IVOCLAR VIVADENT IPS e.max CAD, approx. 75 ml.

**! NOTE: Recommended mixing ratio:**

25ml of DENTATEC with 1l of water.

Deviations are possible for certain materials:

- With IVOCLAR VIVADENT IPS Empress CAD and IVOCLAR VIVADENT IPS e.max CAD, mix approx. 37.5ml with 1l of water.
- With CAD-Waxx, mix approx. 5ml with 1l of water. See also the operating instructions for the corresponding material.

6. Fill the tank up to the notch with water (bottom edge of cover; approx. 2 liters).
7. Reinsert the water filter and close the water tank.
8. Push the water tank back into the housing just far enough so that the tank catch engages (press the catch downward if necessary).

## 5.4.5 Installation

### 5.4.5.1 Connection to the PC

**⚠ WARNING: Electric shock**

Low voltages are applied to the socket (A) for connecting the serial interface.

- Never touch the pins of the connectors.
- Switch the PC **OFF**.

#### Using the RS 232 interface cable

- ✓ The PC is located near the milling unit.
- ✓ The PC and the milling unit are switched off.

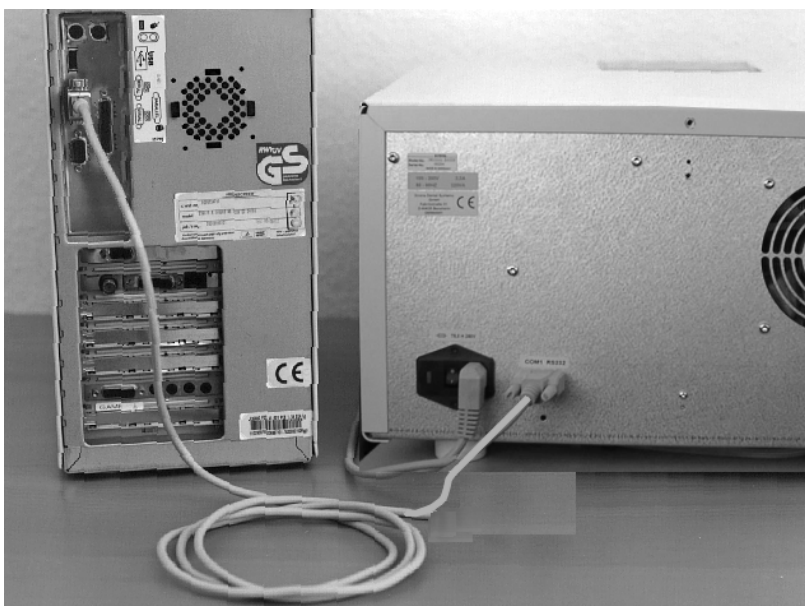
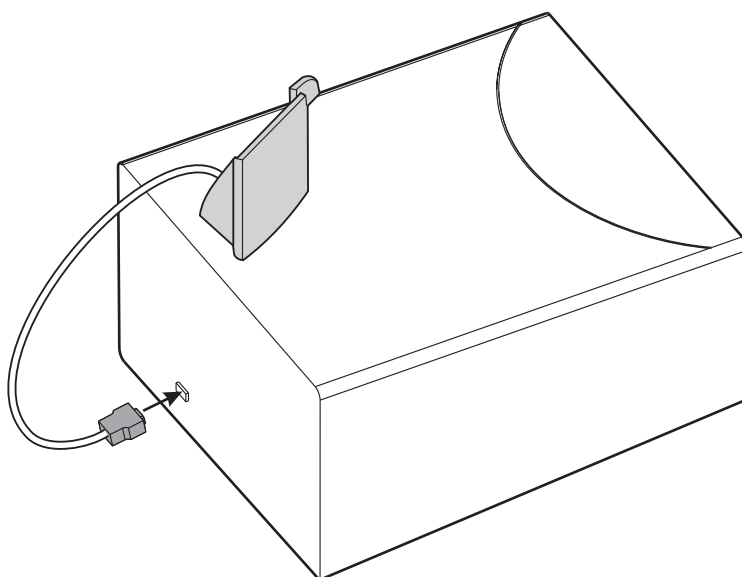

*Fig. 5-6 Connecting the milling unit with the interface cable*

1. Use the supplied interface cable to connect the milling unit to the RS 232 interface of the PC (COM1, COM2).
2. Screw the interface cable onto the PC and milling unit tight in order to ensure reliable operation.

### **Using the DECT radio module (optional)**

#### **Connecting the DECT radio module to the milling unit**



*Fig. 5-7 DECT radio module*

1. If you ordered a DECT radio module, connect it instead of the interface cable and screw it tight.
2. Place it on top of the milling unit as shown.

### Connecting the DECT radio module to the PC

1. Plug the connectors of the RS-232 cable into the radio module and into the RS-232 interface of the PC (COM1, COM2) and screw them tight.
2. Connect the radio module to the power supply using the supplied plug-in power supply unit.

### Using the Höft&Wessel radio module (optional)

#### Connecting the Höft&Wessel radio module to the milling unit

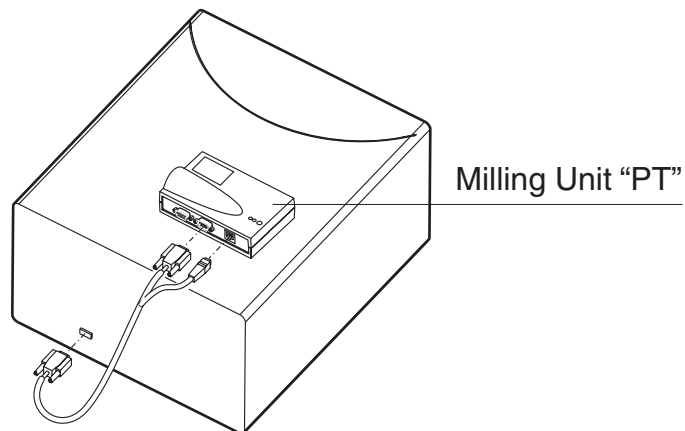

Fig. 5-8 Höft&Wessel radio module for milling unit

1. If you ordered a Höft&Wessel radio module, connect it (with the label **Milling Unit "PT"**) instead of the interface cable and screw it tight.
2. Place it on top of the milling unit as shown.

#### Connecting the Höft&Wessel radio module to the PC

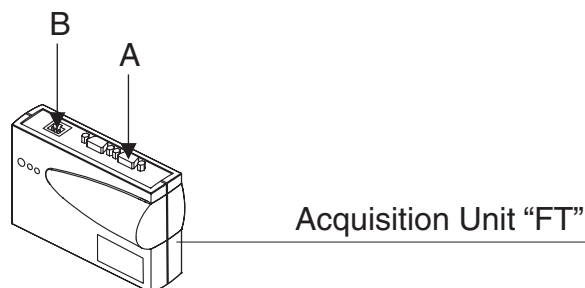

Fig. 5-9 Höft&Wessel radio module for PC

1. Plug the connectors of the RS-232 cable into socket **A** of the radio module labeled **Acquisition Unit "FT"** and into the RS-232 interface of the PC (COM1, COM2) and screw them tight.
2. Connect radio module **B** to the power supply using the supplied plug-in power supply unit.

### 5.4.5.2 Connecting the milling unit to the power supply



**NOTE: Grounded power outlet**

The milling unit must be connected to a grounded power outlet.

- Connect the milling unit to the power supply with the power cable included in delivery.

### 5.4.6 Switching the units on



**CAUTION: Do not put the unit into operation at low temperatures!**

If you move the unit to the operating site from a cold environment, condensation may form and result in a short circuit.

The milling unit contains grease depots for lubricating components which can cause error messages at low temperatures.

- ✓ Install the unit at room temperature.
- Wait until the unit has reached room temperature and is absolutely dry (for at least one hour)
- ↻ The unit is dry and can be put into operation.



**NOTE: Do not adjust the line voltage**

The unit automatically adjusts to the line voltage.

The following three chapters describe how to download the latest software version to the milling unit. Observe the chapter corresponding to the data transmission hardware installed.

### 5.4.6.1 Download via the DECT radio interface

#### Preparations

1. For this installation step, place your PC as close as possible to the milling unit.
2. Switch on the PC. The milling unit must be switched off.

#### Downloading the milling program

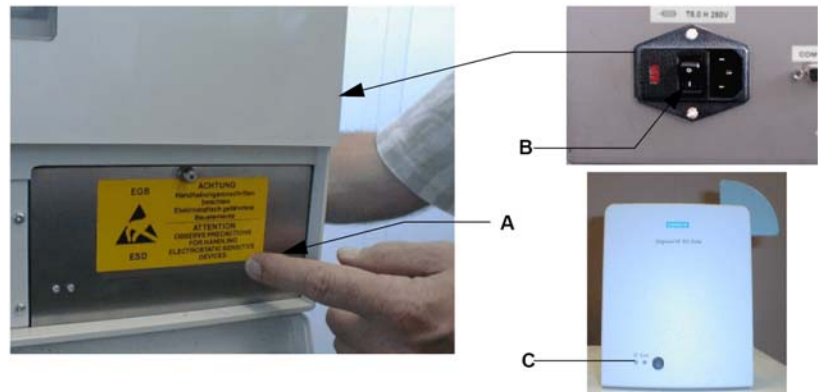

Fig. 5-10 Switching the milling unit on (DECT)

- Switch the milling unit on (B), while keeping the download key (A) pressed. Wait until the left operating indicator (C) of the radio interface on the milling unit lights up continuously. You can now release the Download key on the milling unit.
  - ☞ The green LED on the milling unit is lit and the yellow LED is off.

#### Adding the milling unit in the user software

1. Start the user software
  - ☞ A message stating that no milling machines are set up appears.
2. Confirm this message with "Yes".  
or
  - If you have accidentally clicked "No", select "Settings" / "Configuration" / "Devices...", go to the "Configure Devices" dialog box and click the "Add automatically" button.
    - ☞ The connected milling unit will automatically be detected. The message "Downloading software to COMx" (COM1, COM2, ... – depending on which interface the milling unit is connected to) appears in the status bar of the "Configure Devices" dialog box. Wait until the status display goes out.
3. Enter a name for this milling unit ("Milling unit" is offered as the default name).
4. Click "Add Device".
5. In the next dialog box, place a checkmark in front of "Scanner", in front of "inLab gearhead installed" and, if one is installed, in front of "Large watertank", depending on your system configuration.
6. Click "OK".
  - ☞ Following a successful download, a yellow exclamation mark and the message "No calibration data" appear in the dialog box.
7. Click "OK".
  - ☞ The "Configure Devices" dialog box is closed.

## Calibrating the milling unit and scanner, if necessary

1. Calibrate the milling unit (see "Calibrating the milling unit").
2. If scanner is installed: Calibrate the scanner (see "Calibrating the scanner").
  - 🔗 As soon as the milling unit and the scanner (if necessary) have been calibrated, the installation of the milling unit is completed. A green checkmark and the status "Ready" appear on the icon for the milling unit in the dialog box.
3. If you encounter problems with one of the above points, please observe the information in the appendix.

### 5.4.6.2 Download via the Höft&Wessel radio interface

## Preparations

1. For this installation step, place your PC as close as possible to the milling unit.
2. Switch on the PC. The milling unit must be switched off.

## Downloading the milling program

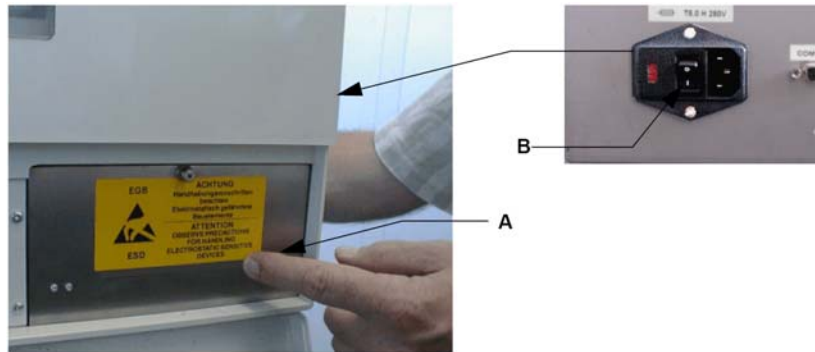

Fig. 5-11 Switching the milling unit on

- Switch the milling unit on (B), **while** keeping the download key (A) pressed. You can release the Download key on the milling unit after approx. 5 seconds.
  - 🔗 The green LED on the milling unit is lit and the yellow LED is off.

## Adding the milling unit in the user software

1. Start the user software
  - 🔗 A message stating that no milling machines are set up appears.
2. Confirm this message with "Yes".
  - or
    - If you have accidentally clicked "No", select "Settings" / "Configuration" / "Devices...", go to the "Configure Devices" dialog box and click the "Add automatically" button.
      - 🔗 The connected milling unit will automatically be detected. The message "Downloading software to COMx" (COM1, COM2, ... – depending on which interface the milling unit is connected to) appears in the status bar of the "Configure Devices" dialog box. Wait until the status display goes out.
3. Enter a name for this milling unit ("Milling unit" is offered as the default name).

4. Click "Add Device".
5. In the next dialog box, place a checkmark in front of "Scanner", in front of "inLab gearhead installed" and, if one is installed, in front of "Large watertank", depending on your system configuration.
6. Click "OK".
  - ↳ Following a successful download, a yellow exclamation mark and the message "No calibration data" appear in the dialog box.
7. Click "OK".
  - ↳ The "Configure Devices" dialog box is closed.

### **Calibrating the milling unit and scanner, if necessary**

1. Calibrate the milling unit (see "Calibrating the milling unit").
2. If scanner is installed: Calibrate the scanner (see "Calibrating the scanner").
  - ↳ As soon as the milling unit and the scanner (if necessary) have been calibrated, the installation of the milling unit is completed. A green checkmark and the status "Ready" appear on the icon for the milling unit in the dialog box.
3. If you encounter problems with one of the above points, please observe the information in the appendix.

### 5.4.6.3 Download using the serial cable supplied

#### Preparations

- Switch on the PC. The milling unit must be switched off.

#### Downloading the milling program

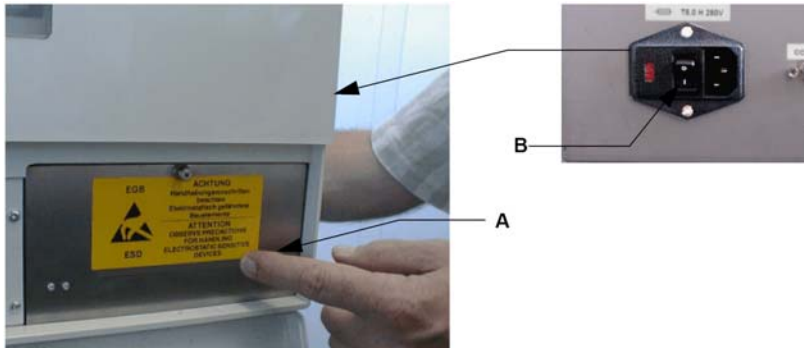

Fig. 5-12 Switching the milling unit on

- Switch the milling unit on (B), **while** keeping the download key (A) pressed. You can release the Download key on the milling unit after approx. 5 seconds.

- ☞ The green LED on the milling unit is lit and the yellow LED is off.

#### Adding the milling unit in the user software

1. Start the user software
  - ☞ A message stating that no milling machines are set up appears.
2. Confirm this message with "Yes".  
or
  - If you have accidentally clicked "No", select "Settings" / "Configuration" / "Devices...", go to the "Configure Devices" dialog box and click the "Add automatically" button.
    - ☞ The connected milling unit will automatically be detected. The message "Downloading software to COMx" (COM1, COM2, ... – depending on which interface the milling unit is connected to) appears in the status bar of the "Configure Devices" dialog box. Wait until the status display goes out.
3. Enter a name for this milling unit ("Milling unit" is offered as the default name).
4. Click "Add Device".
5. In the next dialog box, place a checkmark in front of "Scanner", in front of "inLab gearhead installed" and, if one is installed, in front of "Large watertank", depending on your system configuration.
6. Click "OK".
  - ☞ Following a successful download, a yellow exclamation mark and the message "No calibration data" appear in the dialog box.
7. Click "OK".
  - ☞ The "Configure Devices" dialog box is closed.



## Calibrating the milling unit and scanner, if necessary

1. Calibrate the milling unit (see "Calibrating the milling unit").
2. If scanner is installed: Calibrate the scanner (see "Calibrating the scanner").  
  
🔗 As soon as the milling unit and the scanner (if necessary) have been calibrated, the installation of the milling unit is completed. A green checkmark and the status "Ready" appear on the icon for the milling unit in the dialog box.
3. If you encounter problems with one of the above points, please observe the information in the appendix.

## 5.5 Repacking



### **CAUTION: Repack only drained units!**

Drain the unit! See chapter on "Removing water from the unit". [ 47]

- ✓ The water tank is empty.
  - ✓ The main switch on the back side of the unit is set to the **0** (OFF) position.
1. Disconnect the power cable and the connecting cable from the back side of the unit and stow them away.
  2. Stow away the block changing tool and the torque wrench in their holders (to the left of the water tank).
  3. Check the unit for completeness according to the scope of supply!
  4. Pack the unit securely.

## 5.6 Scope of supply

The exact scope of supply is specified in the document "Checklist CEREC 3".

## 5.7 Storage



### **CAUTION: Only drained units may be stored!**

Drain the unit! See chapter on "Removing water from the unit". [ 47]

Store the unit in a closed and dry room at a temperature of -10°C to 50°C for a maximum period of 12 months.

## 6 Operation

### **⚠ WARNING: Risk of injury on calibration pins/milling instruments**

If you put your hand inside the milling chamber (e.g. to insert/remove a ceramic block, change milling instruments, insert/remove a calibration phantom), it could be injured by the calibration pins/milling instruments.

Be careful not to brush against the calibration pins or milling instruments with your hand.

Always insert your hand in the milling chamber underneath the calibration pins and milling instruments.

### 6.1 Setting the acquisition unit to scanner (onl with integrated scanner)

- ✓ In order to use the integrated scanner, the acquisition system first must be set to "Scanner".
- 1. Select the command "Settings" / "Configuration" / "Acquisition system" in the menu line.
  - ↳ The "Configuration" dialog box appears.
- 2. Select "Scanner" and confirm with "OK".
  - ↳ The scanner will remain selected until you select "3D camera" or "inEos".

### 6.2 Calibrating the unit

#### **⚠ CAUTION: Faulty milling result**

If the unit is not calibrated, the milling result may be faulty.

Calibrate the unit prior to initial use

#### **⚠ CAUTION: Use only the supplied calibration tools**

Calibrate the milling unit only with the supplied calibration pins and the corresponding calibration phantom.

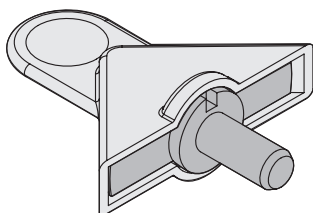

#### **⚠ CAUTION: Scanner failure or calibration error**

If you do not keep the calibration phantom clean, proper calibration cannot be performed.

- Keep the calibration phantom clean; do not touch its sensor area with your bare fingers.
- Always insert and remove the calibration phantom with the calibration protection.
- Place the calibration phantom with calibration protection in the storage box after each calibration.

## 6.2.1 Calibrating the milling unit

### Performing calibration



Fig. 6-1 Tools

A	Block changing tool	B	Torque wrench
---	---------------------	---	---------------

- ✓ The block changing tool, torque wrench and calibration phantom are ready-to-hand.
  - ✓ The milling unit and PC are switched on.
  - ✓ The software has been started.
1. Select the command "Settings" / "Calibration" / "Milling unit" in the menu line.
  2. If several milling units are connected, a dialog box will appear. Select the language you prefer and confirm your choice with "OK".
    - ↳ The milling unit then moves into position to insert the calibration tools. A dialog box prompts you to insert the calibration pins and the calibration phantom and to close the milling chamber door again.
  3. Press the catch of the milling chamber door and open the door.

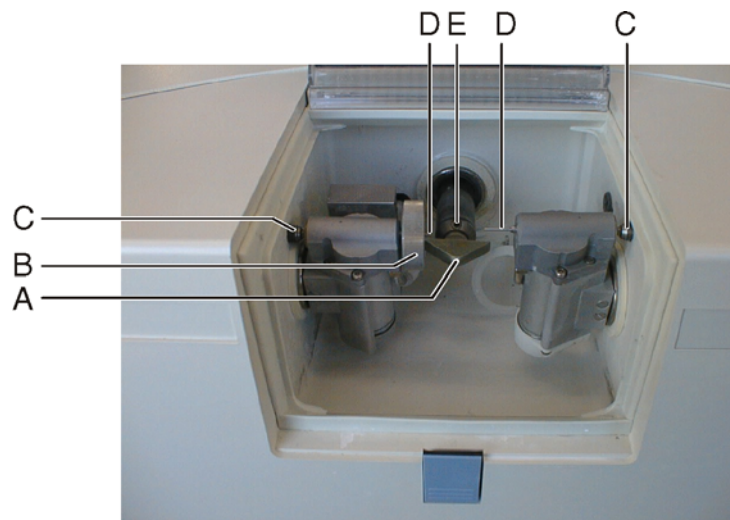

Fig. 6-2 Calibrate the milling unit

- |   |                                   |   |                 |
|---|-----------------------------------|---|-----------------|
| A | Calibration phantom               | B | Torque wrench   |
| C | Catch                             | D | Calibration pin |
| E | Setscrew in the workpiece spindle |   |                 |

- Loosen the milling instruments with the torque wrench and pull them out manually.
- Insert the calibration phantom in the workpiece spindle so that its groove fits into the locking pin of the workpiece spindle.
- Fasten the calibration phantom with the setscrew.
- Turn the calibration pins into the motor mount by hand. Tighten the corresponding chuck with the torque wrench until a clicking sound can be heard.
- Close the milling chamber door.
- Confirm by clicking the "Calibrate milling unit" button in the "Start" dialog box.
  - The automatic calibration begins and takes approx. 4 minutes.
- Open the milling chamber door following calibration.
- Loosen the calibration pins with the torque wrench and pull them out manually.



**NOTE: Store the calibration tools in a safe place**

Store the calibration pins and calibration phantom in a safe place (storage box).

- Remove the calibration phantom.

 **CAUTION: Use only suitable milling instruments!**

Do not use CEREC 2 milling instruments with chuck (1.2 mm) or 2.0 mm milling instruments in this milling unit.

If you use the milling unit in connection with the inLab 3D software, you can use additional milling instruments. In this regard, observe the following two safety instructions.

The Cone Bur 12 and Step Bur 12 milling instruments may be used only in milling units with long travel ranges (Serial No. 5000 or higher).

The Step Bur 14 and Cone Bur 14 milling instruments are used in connection with the inLab gearing (serial number 11 200 and higher) to process the following asymmetric blocks:

- VITA In-Ceram 2000 YZ CUBES: YZ-55 (Flip Block), YZ-20/19, YZ-40/19
- VITA In-Ceram 2000 AL CUBES: AL-20, AL-40

Any use of other materials may result in failures when creating the restoration and cause damage to the unit.

## Reinserting the milling instruments

1. Insert the milling instruments in the motor mount by hand. Tighten the corresponding chuck with the torque wrench until a clicking sound can be heard.

 **NOTE:**

A synoptical table of the milling instruments and the materials that can be milled using them is provided in the Chapter "Overview of materials and milling instruments".

2. Close the milling chamber door.
  - ↳ The dialog box for selecting the milling instruments then appears.

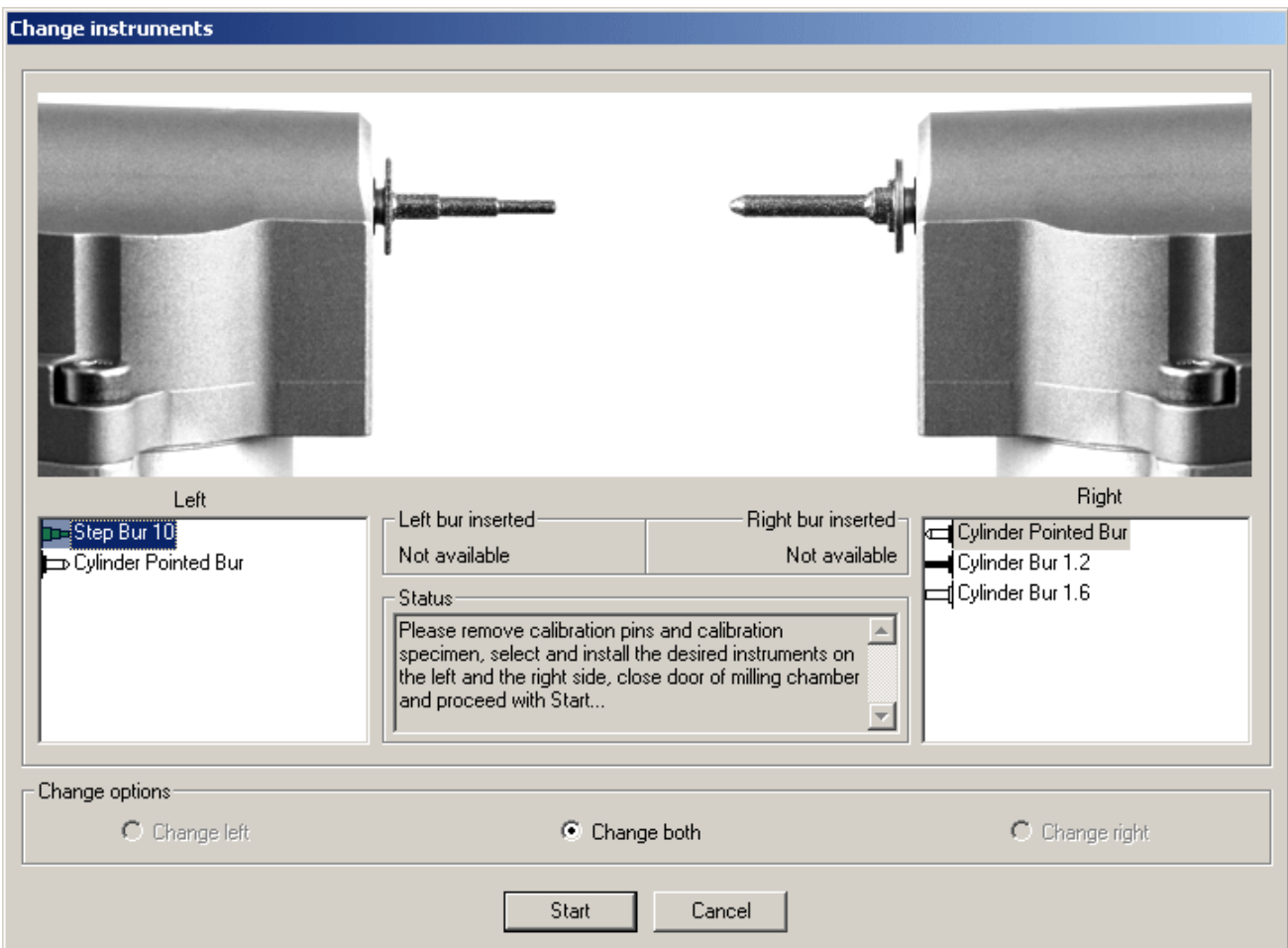

Fig. 6-3 Changing milling instruments

3. Select the milling instrument **that you inserted in the left gearing** from the "Left" list and **the milling instrument that you inserted in the right gearing** from the "Right" list.
4. Confirm this procedure with "Start"

## 6.2.2 Calibrating the scanner (only with integrated scanner)

- ✓ The block changing tool and calibration phantom are ready-to-hand.
- ✓ The milling unit and PC are switched on.
- ✓ The software has been started.
- 1. Select the command "Settings" / "Calibration" / "Scanner" in the menu line.
- 2. If several milling units are connected, a dialog box will appear. Select the language you prefer and confirm your choice with "OK".
  - ↳ The milling unit moves into the calibration tool insertion position. A dialog box then prompts you to insert the calibration phantom and close the milling chamber door.
- 3. Press the catch of the milling chamber door and open the door.
- 4. Insert the calibration phantom with the calibration protection in the workpiece spindle so that its groove fits into the locking pin of the workpiece spindle.
- 5. Fasten the calibration phantom with the setscrew.
- 6. Pull off the calibration protection.
- 7. Close the milling chamber door.
- 8. Confirm by clicking the "Calibrate milling unit" button in the "Start" dialog box.
  - ↳ The automatic calibration begins and takes approx. 1 minute.
- 9. Open the milling chamber door following calibration.



### **NOTE: Store the calibration tools in a safe place**

Store the calibration phantom with calibration protection in a safe place (storage box).

- 10. Set the calibration protection upright and remove the calibration phantom.
- 11. Close the milling chamber door.

## 6.3 Starting the scanning process (only with integrated scanner)

- ✓ The acquisition system must be set to "Scanner", see "Setting the acquisition system to scanner".
- 1. Prepare the model holder as described in the chapter "Preparing optical scanning".
- 2. Create a new restoration (see user's manual, chapter on "Creating a new restoration").
- 3. If several milling units are connected, a dialog box will appear. Select the language you prefer and confirm your choice with "OK".



- 4. Click the acquisition icon.

☞ The "Scanner" dialog box opens.

- 5. The milling unit then moves to the insertion position.

☞ A new dialog box then appears prompting you to insert a model holder and close the milling chamber door.

- 6. Press the catch of the milling chamber door and open the door.

### **⚠ WARNING: Sharp edges on scanner!**

The scanner on the left milling unit has sharp edges which could cause personal injury.

Be careful not to brush against the scanner with your hand.

- 7. Insert the model holder in the workpiece spindle so that the groove of the model holder fits into the locking pin of the workpiece spindle.
- 8. Fasten the model holder with the setscrew.

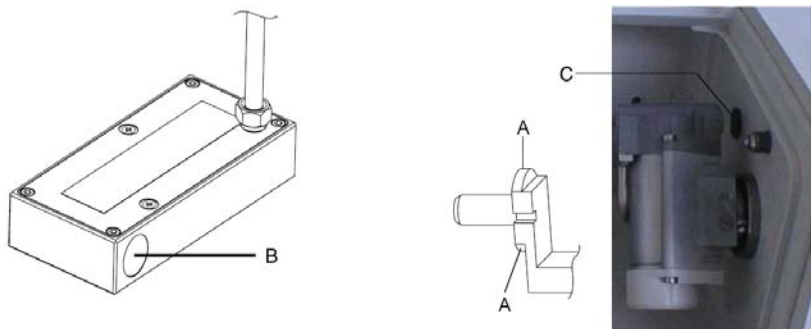

Fig. 6-4 Scanner window

A Circular segment areas

C Reference point

B Scanner window



 **CAUTION: The calibration phantom must remain free of dirt and grime**

Make sure that the scanner window, the reference point, the circular segment areas and the milling chamber door are kept free from drops of cooling water, lime and milling dust deposits.

Otherwise there is a risk of scratching the scanner window when wiping it clean with the cloth in case of milling dust deposits.

- Prior to wiping off the scanner window, you must spray it with clear water to remove any milling dust residues.
- Clean the scanner window, the reference point, the circular segment areas and the milling chamber door with a soft cloth.

9. Close the milling chamber door and confirm the process by clicking "Start"

 A two-dimensional image of the scanned model appears in the background on the monitor.

The expected duration of the scanning process is indicated by a bar displayed in a message window. This window closes as soon as the scanning process has been completed.

 **NOTE: Cancel the scanning process**

You can cancel the scanning process at any time by pressing the "Stop" button.

10. Press the catch of the milling chamber door and open the door.
11. Loosen the setscrew on the spindle and pull out the model holder.

## 6.4 Start the milling process

### Start the milling process



- ✓ Load or design a restoration (see Operator's Manual, Chapter on "Design").
- 1. Start the milling process by clicking the "Mill" icon.
- 2. If several milling units are connected, a dialog box will appear. Select the language you prefer and confirm your choice with "OK".
- 3. Select the milling instruments if necessary.

A synoptical table of the milling instruments and the materials that can be milled using them is provided in the Chapter "Overview of materials and milling instruments" [42].

### Performing the milling process



#### **NOTE: Selecting the milling instruments**

Following installation, the inserted combination of milling instruments may still be unknown to the software. In this case, a dialog box will automatically open where you then must select the milling instruments currently inserted in the milling unit:

- ✓ The dialog box is open.
- Select the milling instrument which you have inserted in the **left motor mount** from the "Left" list.
- Select the milling instrument which you have inserted in the **right motor mount** from the "Right" list.

1. Select the required material from the "Select block" dialog box which then appears.
2. Select the required block size.



#### **NOTE: Error during touch process**

Incorrect specification of the block manufacturer or block selection may lead to failure of the touch process.

3. Confirm your selection with the "OK" button.
  - ↳ The milling unit then moves to the insertion position.
4. Press the catch of the milling chamber door and open the door.



#### **CAUTION: Error message during touch process!**

Always be sure to insert the ceramic block that you selected in the "Select block" dialog box. Otherwise an error message will be displayed during the touch process.

5. Insert the calibration phantom in the workpiece spindle so that its groove fits into the locking pin of the workpiece spindle.
6. Fasten the ceramic block with the setscrew.
7. Close the milling chamber door and confirm the process by clicking "Start"
  - ↳ The estimated time required for the milling process will then appear in a message window.

**! NOTE: Canceling the milling process**

You can cancel the milling process at any time by pressing the "Stop" button.

## Removing the restoration

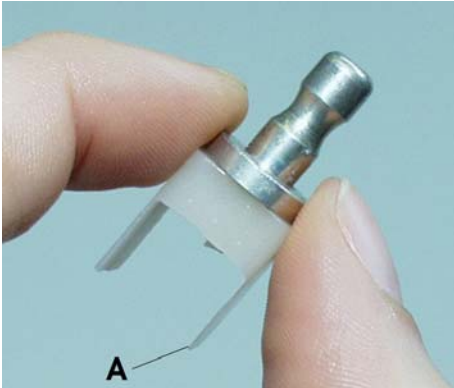

1. When the milling process has been completed, open the milling chamber door.
2. Remove the restoration.

**! WARNING: Risk of injury on the remainder of the ceramic block**

The remaining portion of the ceramic block may have sharp edges (e.g. **A**) that could injure you if it is not removed carefully.

Always grasp the remainder of the ceramic block by its metal holder.

3. Loosen the setscrew on the spindle and remove the rest of the ceramic block.

**! NOTE:**

After a certain operating time, the surfaces of the shafts will get a mirror finish. This has no influence on the accuracy of the milling result.

4. Close the milling chamber door.

**! WARNING: Do not use defective milling results!**

Milling results must be judged by the user (dentist or dental technician) and must not be used if defects are detected!

## 6.5 Preparing optical scanning (only with integrated scanner)

### 6.5.1 Information on preparing models for implants

**NOTE: Prerequisites**

This information applies only under the following conditions:

- Milling units with integrated scanner
- PC with installed inLab 3D software

- ✓ A master model with manipulation implants is available.
1. Plug a scanbody onto each manipulation implant of the master model until it comes to rest on the shoulder of the implant without any gaps.
  2. Prepare a scan model by duplicating each implant situation. The scanbody of the scan model must be facing **upward vertically**. It must be visible without undercuts.
  3. Glue this model onto the model holder in such a way that it points toward the clamping shank in the **mesial** → direction.

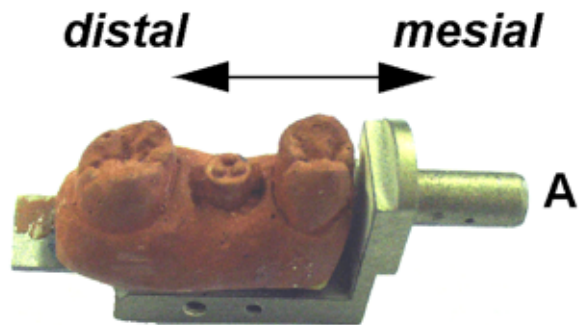

Fig. 6-5

A Clamping shank

### 6.5.2 Creating a model



**NOTE: KwikkModel as modeling compound**

The following instructions are based on the use of KwikkModel® as modeling compound

- ✓ An impression with alginate, hydrocolloid or polyether is made (see operating instructions for casting materials).
- 1. Fill the impression with the modeling compound (see operating instructions for modeling compound).



**NOTE: Observe the position and insertion axis**

The prepared tooth should lie as near the center of the model holder as possible. Make sure the model holder is positioned vertical to the insertion axis.

- 2. Within 10 seconds press the model holder on the compound.
- 3. Let the compound harden for about 2 minutes.
- 4. Remove the model holder with the model from the form.



**NOTE:**

Using polyether, let the model cure for about two minutes (see also the operating instructions for the modeling compound).

- 5. With a scalpel cut away the areas unnecessary for the scanning process.

**Fastening the model**

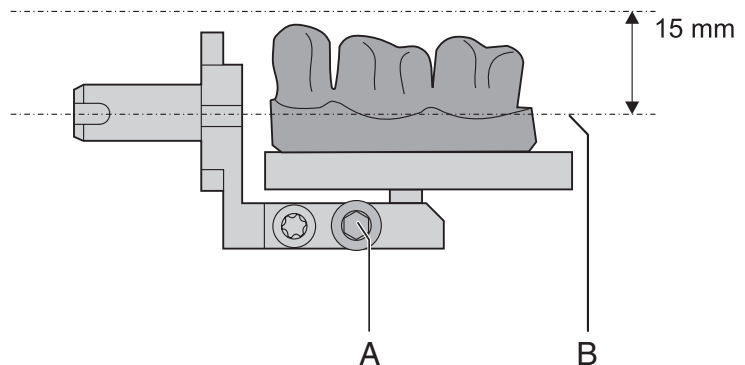

Fig. 6-6 Position of the model

A	Allen screw	B	Center line
---	-------------	---	-------------

- ✓ The preparation margin is not visible from all sides.
- Fasten the model in the correct position with the Allen screw.

**Valid scan range of the model:**

- The lowest area must not lie more than 2 mm below the center line of the model holder.
- The highest area must not lie more than 15 mm above the center line of the model holder.

**6.5.3 Preparing for scanning of the veneer model**

- ✓ You have made a model of the clinical situation in the usual manner.
- Glue this model onto the model holder. The prepared labial surface must point toward the slot on the model holder.
- ↪ The holder is automatically turned so that the scanning process can be performed from the labial direction.

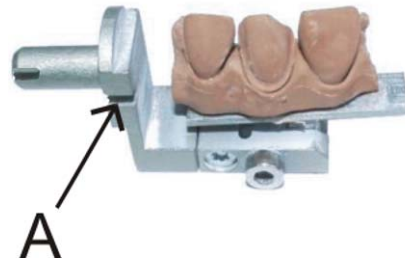

Fig. 6-7 Veneer model

A Slot on model holder

## 7 Maintenance



### **NOTE: Observe national regulations!**

Some countries have legal regulations which require regular safety inspections of electrical devices or systems by the operator.



### **NOTE: Perform maintenance regularly!**

Have maintenance performed on your unit annually by trained technical personnel / a service engineer.



### **NOTE: Observe error messages**

You must observe error messages shown on the display on in the software. If the error message does not disappear even after you have performed the prompted action, contact your service engineer.



### **NOTE: Clean water paths regularly**

Clean the water paths annually using the DENTACLEAN cleaning set.

### 7.1 Changing the water

#### 7.1.1 General information



### **CAUTION: Damage to the pump and milling drives!**

An excessively high ceramic content in the cooling water will damage the pump and milling drives.

Change the water regularly!

When it is time for the water to be changed, a message window appears on your monitor to remind you that it is time to change the water.

#### **Preventing odors**



### **NOTE: Odors!**

All milling additives contain a biologically degradable preservative. Despite this, however, odors may still develop under unfavorable conditions.

Observe the following:

- Change the water at least once a week.
- With ambient temperatures above 25°C, change the water every 2 to 3 days to prevent foul odors.
- Drain the tank if you do not intend to operate the unit for more than one week.
- Clean the tank if the odors recur.
- Add DENTATEC milling additive and fill the tank up to the brim with water. Let it stand for at least 24 hours and then rinse it out thoroughly with water once again.

**⚠ CAUTION: Damage to surfaces!**

DENTATEC milling additive etches plastic surfaces in undiluted form and can cause discoloration.

- Do not place DENTATEC on the unit.
- Do not spill DENTATEC.

**⚠ CAUTION: Permissible milling additive**

Use only DENTATEC as a milling additive.

### 7.1.2 Changing the water

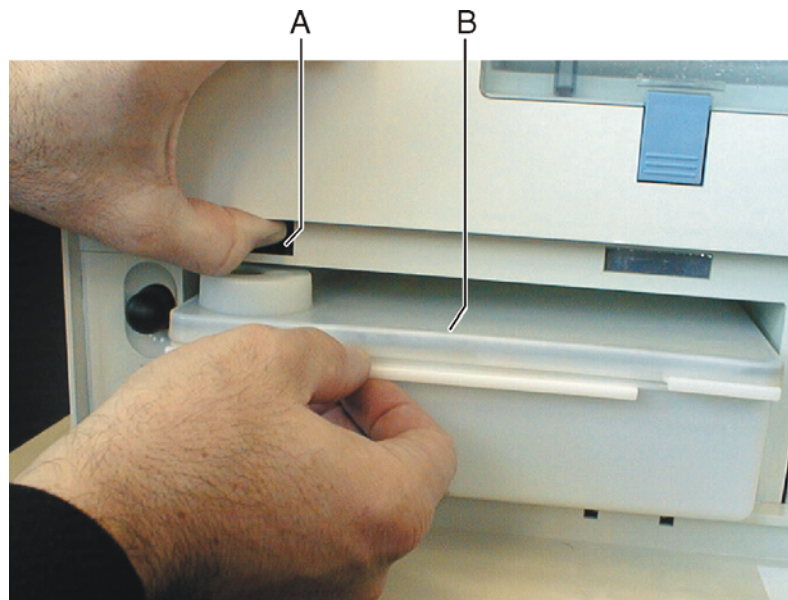

Fig. 7-1 2 liter water tank

A	Tank catch	B	Water tank
---	------------	---	------------

When changing the water, proceed as follows:

- ✓ The unit is switched on.
  - ✓ No milling/scanning process is running.
1. Open the flap on the front panel of the unit.  
To open the front flap, pull it on both sides.
  2. Press the tank catch upward and carefully pull out the water tank toward the front of the unit.
  3. Drain the water out of the water tank through the drain opening.





4. Open the water tank and rinse it out.
5. Check the water tank and the filter for dirt and contamination.
6. If the water tank or the filter is dirty, clean it thoroughly under running water. Detach the filter, rinse it out with water, and then reinsert it.

 **CAUTION: Inadmissible foam!**

If any cleaning agents are used, this will result in an inadmissible foam.  
Do not use any cleaning agents.

7. Add approx. 50 ml\* of DENTATEC to the tank.  
or
  - \* With the materials IVOCLEAR VIVADENT IPS Empress CAD and IVOCLEAR VIVADENT IPS e.max CAD, approx. 75 ml.

 **NOTE: Recommended mixing ratio:**

25ml of DENTATEC with 1l of water.

Deviations are possible for certain materials:

- With IVOCLEAR VIVADENT IPS Empress CAD and IVOCLEAR VIVADENT IPS e.max CAD, mix approx. 37.5ml with 1l of water.
- With CAD-Waxx, mix approx. 5ml with 1l of water. See also the operating instructions for the corresponding material.

8. Fill the tank up to the notch with water (bottom edge of cover; approx. 2 liters).
9. Close the water tank.
10. Push the water tank back into the housing just far enough so that the tank catch engages (press the catch downward if necessary).

## 7.2 Milling instruments

### 7.2.1 Overview of materials and milling instruments

The following table shows the two pairs of milling instruments, the positions where they must be inserted and the materials that can be milled with each instrument pair:

Milling instrument "Left"	Milling instrument "Right"	Material
Step Bur 10	Cylinder Pointed Bur	CEREC Blocs
		CEREC Blocs PC
		VITA MARK II
		VITA ESTHETIC LINE
		VITA TriLuxe
		IVOCLAR VIVADENT IPS Empress CAD
		IVOCLAR VIVADENT IPS Empress CAD Multi
		IVOCLAR VIVADENT IPS e.max CAD
		VITA In-Ceram ZIRCONIA
		VITA In-Ceram ALUMINA
		VITA In-Ceram SPINELL
		Merz Artegral
		Sirona inCoris ZI
		Sirona inCoris AL
		VITA In-Ceram YZ
VITA In-Ceram AL		
IVOCLAR VIVADENT IPS e.max ZirCAD		

## 7.2.2 Changing milling instruments (burs)

### Unscrewing the milling instruments



#### **NOTE: Regular replacement of the Milling instruments**

Change the milling instruments as soon as the system prompts you to do this.

Change the milling instruments after using them to mill 25 restorations at the latest.

After 30,000 minutes of milling operation, a maintenance prompt is displayed during each milling instrument change until the service technician performs maintenance and the milling time is reset.

- ✓ The torque wrench is ready-to-hand.
- 1. Select the command "Settings"/ "Instruments" in the menu line.
- 2. If several milling units are connected, a dialog box will appear. Select the language you prefer and confirm your choice with "OK".
  - 👉 The motors travel to the change position for the milling instruments. The "Change instruments" dialog box opens.
- 3. Press the catch of the milling chamber door and open the door.



#### **WARNING: Risk of injury on milling instruments**

If you put your hand in the milling chamber, you could injure it on the milling instruments.

Be careful not to brush against the milling instruments with your hand.

- 4. Loosen the worn out/defective milling instrument with the torque key and unscrew it counterclockwise by hand.



#### **CAUTION: Use only suitable milling instruments!**

Do not use CEREC 2 milling instruments with chuck (1.2 mm) or 2.0 mm milling instruments in this milling unit.

If you use the milling unit in connection with the inLab 3D software, you can use additional milling instruments. In this regard, observe the following two safety instructions.

The Cone Bur 12 and Step Bur 12 milling instruments may be used only in milling units with long travel ranges (Serial No. 5000 or higher).

The Step Bur 14 and Cone Bur 14 milling instruments are used in connection with the inLab gearing (serial number 11 200 and higher) to process the following asymmetric blocks:

- VITA In-Ceram 2000 YZ CUBES: YZ-55 (Flip Block), YZ-20/19, YZ-40/19
- VITA In-Ceram 2000 AL CUBES: AL-20, AL-40

Any use of other materials may result in failures when creating the restoration and cause damage to the unit.

### Inserting the new milling instrument

- 1. Screw the new milling instrument into the gearing by turning it clockwise by hand; then tighten it securely with the torque key until you hear an audible clicking noise.



#### **NOTE: Faulty milling results**

Interchanging milling instruments leads to faulty milling results.

- 2. Close the milling chamber door.

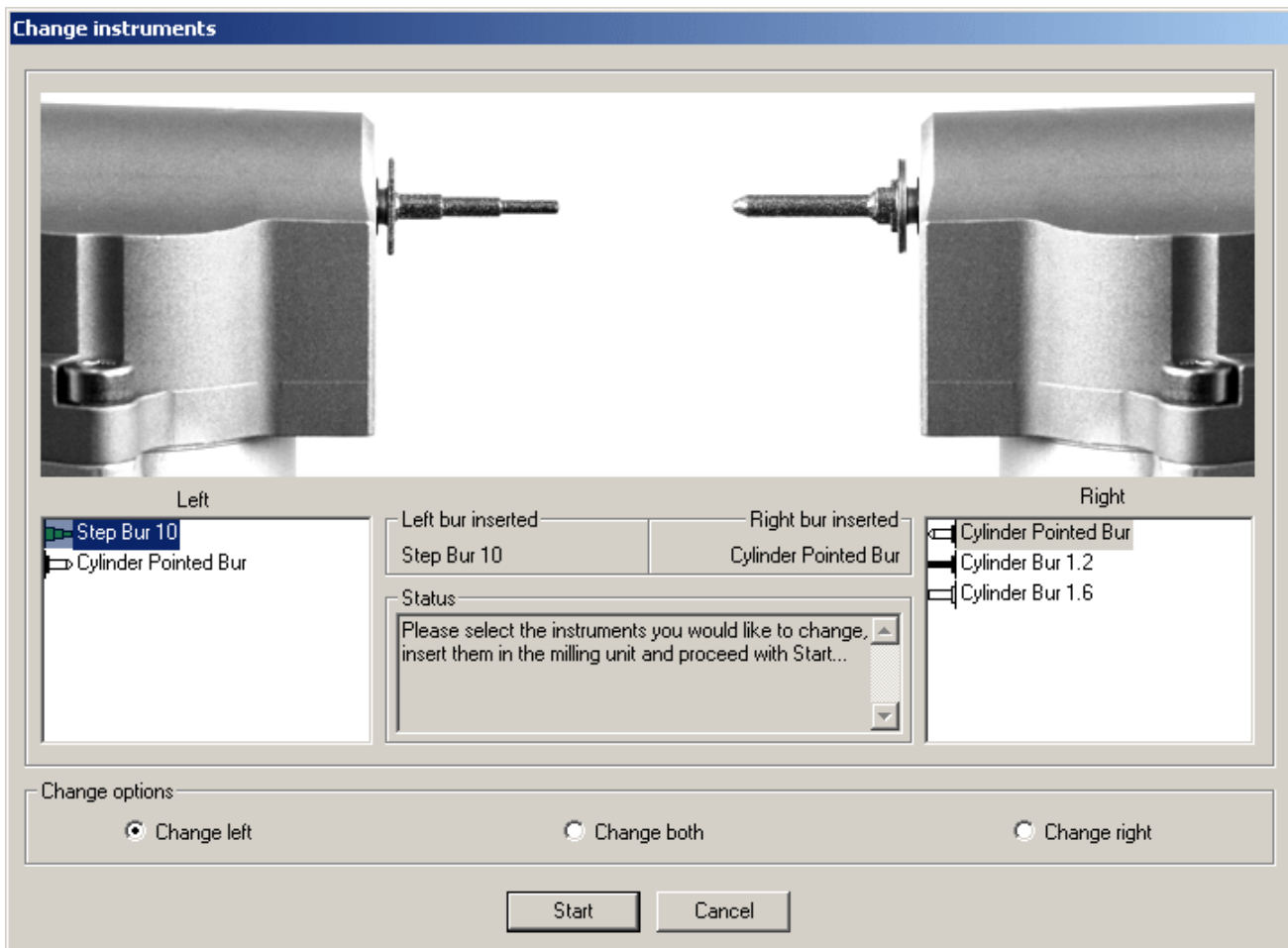

Fig. 7-2 a defective milling instrument

3. Select the milling instrument(s) you have inserted on the PC and click "Start" (also refer to Operator's Manual).

**⚠ CAUTION: Cleaning cooling water nozzles**

The cooling water nozzles in the milling chamber always must be kept free of lime and milling dust deposits. The corresponding cooling water jet always must strike the milling instrument accurately!

- ✓ The cooling water nozzles are dirty.
- Clean the nozzles with a cleaning wire and the SPRAYVIT syringe (if available).

**Changing a defective milling instrument**

If a milling instrument breaks during a milling operation, the corresponding motor travels to the change position. A dialog box which marks the side with the broken milling instrument with a red cross then opens.

- ✓ The milling instrument is broken.
1. Change the defective milling instrument as described above.
  2. Select the milling instrument which you have inserted.
  3. Press the "Start" button.

## 7.3 Care and cleaning agents

 **CAUTION: Approved care and cleaning agents**  
Use only care and cleaning agents which have been approved by Sirona!

A list of care and cleaning agents is provided in the Appendix.

A continuously updated list of approved agents can be downloaded from the internet at:

"www.sirona.com" / "SERVICE" / "Downloads" / "Care and cleaning agents"

If you do not have any access to the internet, you can order the list in one of the following two ways:

- Order from your local dental depot
- Order from Sirona:  
Tel: ++49 (0) 62 51 / 16-16 16  
Fax: ++49 (0) 62 51 / 16-18 18

Order No.: **59 70 905**

## 7.4 Cleaning surfaces

 **CAUTION: Care and cleaning agents**  
Use only cleaning and care agents which have been approved by Sirona, see Cleaning and care agents [■ 45].

 **CAUTION:**  
Do not allow liquids to run into the ventilation slots!

### 7.4.1 Disinfecting

Wiping off surfaces with surface disinfectants (wipe disinfection).

Observe the manufacturer's instructions regarding restrictions for use.

### 7.4.2 Protection against medicaments

Due to their high concentrations and the substances they contain, many medicaments can dissolve, etch, bleach or discolor surfaces.

 **CAUTION: Damage to the surface**  
Clean the surface immediately with a moist cloth and a cleaning agent.

### 7.4.3 Cleaning

Remove dirt, grime and disinfectant residue regularly using mild, commercially available cleaning agents.

## 7.5 Replacing the main fuses



### **WARNING: Electric shock**

Disconnect the power plug at the unit end before replacing the fuses.



### **CAUTION: Fuse type**

Use only fuses of the same type in the fuse holder!

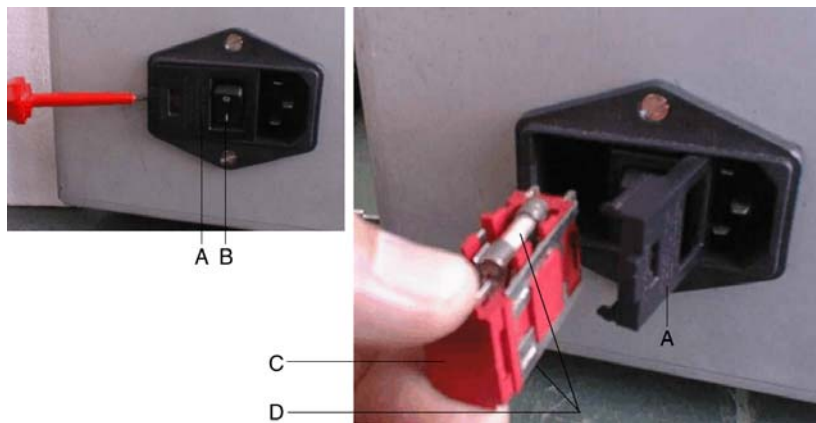

Fig. 7-3 Main fuses

A	Cover	C	Fuse holder
B	CC	D	Fuse

Fuses: T5H250V Order No. 20 33 111

- ✓ The power plug must be disconnected.
- 1. Use a screwdriver to carefully pry off the cover of the fuses on the back side of the unit.
- 2. Pull out the fuse holder.
- 3. Replace the defective fuses.
- 4. Reinsert the fuse holder.
- 5. Close the cover.

## 7.6 Removing water from the unit

You must remove the water from the unit if you will not be using it for a longer period of time or wish to transport it.

- ✓ No milling/scanning process is running.
- 1. Open the flap on the front panel of the unit.  
To open the front flap, pull it on both sides.
- 2. Press the tank catch upward and carefully pull out the water tank toward the front of the unit.
- 3. Open the water tank, drain it and reinsert it.
- 4. You can start the service program after installing the CEREC 3D program in the "CEREC" program group. To do this, click "Start" / "Programs" / "CEREC" / "Service".
- 5. You can also change the water of the milling unit **without** a service password by clicking the "Maintenance only" button.
- 6. Let the water pump continue running until no more water comes out of the nozzles (approx. 1 min.).
- 7. Pull out the water tank and empty it.
- 8. Push the water tank back into the housing just far enough so that the tank catch engages (press the catch downward if necessary).

## 8 Technical description

### 8.1 System requirements

**Working without the acquisition unit** An inLab system PC is required to run this software. The hardware version must be **PC Hardware A** or higher.

**Working with the acquisition unit** If you work with the acquisition unit, it must have the hardware status **PC Hardware EA** or higher.

### 8.2 Milling unit

- Digital feed control with force monitoring for extremely sensitive processing of ceramic materials
- Process-controlled milling motors
- Positioning step size: 12,5 µm
- Milling repeatability: +/- 30 µm
- Milling speed: approx. 0.4-0.6 mm/min

**Milling instruments** (performance-monitored, backlash-free bearing)

- Grain size: 64 µm
- Speed: 40.000 rpm
- **Step Bur 10** included in the scope of supply
- **Cylinder Pointed Bur** included in the scope of supply
- Cylinder Bur 1.2 mm optionally available
- Cylinder Bur 1.6 mm optionally available



**NOTE:**

You will find an overview of the old and new designations for the milling instruments in the table in the appendix.



### 8.2.1 Technical data

Type designation	Milling unit CEREC 3
Rated line voltage	100V - 230V AC
Rated power frequency	50/60 Hz
Rated current	1.5 - 3.5 A
Nominal power output:	320 VA
Permissible line voltage fluctuations	±10% of nominal voltage
Type of protection against electric shock	Unit classified as a Class 1 device
Degree of protection against ingress of water	Ordinary device (without protection against ingress of water)
Overvoltage category	II
Ambient conditions	For indoor use Pollution degree 2 Air pressure: 700 hPa – 1060 hPa
Temperature range	5°C to 40°C
Humidity range	80% rel. up to 31°C decreasing to 50% rel. up to 40°C
Mode of operation	Continuous operation
Dimensions (WxHxD) in mm	480 x 250 x 440
Approx. weight	30 kg

### 8.2.2 Scanner for optical measurement of the preparation (option)

- Noncontact optical measurement
- Digital control of the axes for fast measurement
- Measuring speed: approx. 2 mm/min
- Measuring technique: active triangulation
- Active suppression of reflections
- Low noise photodiode array
- Laser light source:

Wavelength	670 nm
Focus diameter	≤25 µm

- Scan range:

Scanning technique:	45° model	40x20x16 (LxWxH in mm)
	15° model	40x20x12 (LxWxH in mm)
	Crown framework	16x25 (dia. x L in mm)

### 8.2.3 Controller board:

- Real Time Micro Controller Board C167
- 6-axis stepping motor controller
- 2 DC motor controllers with integrated speed and current control
- RS-232 interface 115kBaund

## 8.3 Radio module (optional)

### European/US radio interface (Höft & Wessel)

Transmission speed:	115.2 kBaud
Range:	up to 60m indoors, up to 300m outdoors
Data interface;	RS-232
Operating temperature	0°C to +55°C

### Radio interface, DECT/T-Sinus 45 Data 1 (Telekom)

Transmission speed:	115.2 kBaud
Range:	up to 50m indoors, up to 300m outdoors
Data interface;	RS-232
Operating temperature	+5°C to +45°C

## 9 Appendix

### 9.1 Procedure in case of problems downloading via the DECT radio interface

See "Download via the DECT radio interface"

1. Make sure that the radio interface(s) is (are) correctly connected.
2. Shut down the PC and switch it off. Unplug the plug-in power supply of the PC radio interface from the power outlet for 5 seconds. Switch the milling unit off. Restore all cable connections and test these. Start over again at **Preparations**, Item 2.
3. Open the "Settings" / "Configuration" / "Devices..." menu. Select the required milling unit in the "Configure Devices" dialog box and click the "Configure" button. Make sure that the correct COM interface and baud rate have been selected. The baud rate must be set to **115200**. If an optical impression unit is used, set the COM 1 port. When using a PC set the port to which the radio interface is connected.
4. Should the installation of the software on the milling unit fail again, attempt the installation using the serial cable supplied.

### 9.2 Procedure in case of problems downloading via the Höft&Wessel radio interface

See "Download via the Höft&Wessel radio interface"

1. Make sure that the radio interface(s) is (are) correctly connected.
2. Shut down the PC and switch it off. Unplug the plug-in power supply of the PC radio interface from the power outlet for 5 seconds. Switch the milling unit off. Restore all cable connections and test these. Start over again at **Preparations**, Item 2.
3. Open the "Settings" / "Configuration" / "Devices..." menu. Select the required milling unit in the "Configure Devices" dialog box and click the "Configure" button. Make sure that the correct COM interface and baud rate have been selected. The baud rate must be set to **115200**. If an optical impression unit is used, set the COM 1 port. When using a PC set the port to which the radio interface is connected.
4. Should the installation of the software on the milling unit fail again, attempt the installation using the serial cable supplied.

### 9.3 Procedure in case of problems downloading with the supplied serial cable

See "Download using the serial cable supplied"

1. Shut down the PC and switch it off. Switch the milling unit off. Restore all cable connections and test these. Make sure that you have used the 2 meter long serial interface cable supplied. Start over again at **Preparations.**
2. Open the "Settings" / "Configuration" / "Devices..." menu. Select the required milling unit in the "Configure Devices" dialog box and click the "Configure" button. Make sure that the correct COM interface and baud rate have been selected. The baud rate must be set to **115200**. When using an acquisition unit with external interface extension set the COM 2 port. When using an acquisition unit without external interface extension, you must proceed as for a PC and select the port to which the serial cable is connected.

### 9.4 Overview of old and new designations for milling instruments

Old designation on packaging	New designation on packaging	Order No.	Quantity per package
Step - burr Diamond XL	Step Bur 12	60 52 265	6
Cone - shaped Cylinder Diamond dia. 1.6 mm	Cylinder Pointed Bur	58 55 734	6
Cylinder Diamond dia. 1.2mm – long	Cylinder Bur dia. 1.2	54 66 151	10
Cylinder Diamond dia. 1,6mm – long	Cylinder Bur dia. 1.6	54 66 193	6
Cone - shaped Diamond	Cone Bur 10	58 85 103	6
Cone - shaped Diamond XL	Cone Bur 12	59 35 668	6
Cone - Diamond "Flip - Block" 14 mm	Cone Bur 14	59 99 771	6
-	Step Bur 10	60 89 010	6
-	Step Bur 14	60 89 028	6

# Index

## B

Block changing tool  
27

Building installation 10

## C

Calibration phantom  
28

Calibration pin  
28

Calibration tools  
Calibration phantom 26  
Calibration pins 26  
Storage 28, 31

Care and cleaning agents 45

CC 15

CE mark 9

change  
Milling instruments 43

Cooling water nozzles 44

## D

Dimensions 49

Disinfection 45

## F

Footprint 13

Front flap  
14

Fuse  
Fuse type 46  
Order Number 46  
replacement 46

## H

Humidity range 49

## I

Installation site 13

Intended use 9

## **L**

- Laser class
  - Class 1 11
  - Class 2 11
- LEDs
  - 14

## **M**

- Maintenance 10
  - Regulations 39
- Measuring technique 50
- Milling chamber
  - 14
- Milling chamber door
  - Catch 14
- Milling instruments 29, 43, 48
  - Changing a defective instrument 44
- Milling speed 48
- Milling unit
  - Overview 14
- Mode of operation 49

## **P**

- Packaging 13
- Packing 25
- Ports 15
- Power connection 15
- Product safety 10
- Protection class 49

## **R**

- Rated current 49
- Rated line voltage 49
- Repair 10

## **S**

- Scan range 50
- Scanning technique 50
  - 15° model 50
  - 45° model 50
  - Crown framework 50
- Scope of supply 25

Setscrew  
28

START button  
14

STOP button  
14

## **T**

Tank catch 16, 40

Temperature range 49

Torque wrench  
27, 28

Transport 13

Type designation 49

## **U**

Unpacking 13

## **W**

Warranty 8

water 49

Water tank

    Changing the water 40

    Filling 16

    Odors 39

    Removing water from the unit 47

    Water change 39

Weight 49





---

We reserve the right to make any alterations which may be required due to technical improvements.

© Sirona Dental Systems GmbH 2009  
D 3329.201.01.20.02 02.2009

Sprache: englisch  
Ä.-Nr.: 111 106

Printed in Germany  
Imprimé en Allemagne

---

**Sirona Dental Systems GmbH**

Fabrikstraße 31  
64625 Bensheim  
Germany  
www.sirona.com

**in the USA:**

Sirona Dental Systems LLC  
4835 Sirona Drive, Suite 100  
Charlotte, NC 28273  
USA

Order No **58 35 595 D 3329**