

Gateway Services User Guide

**Oracle FLEXCUBE Universal Banking**

Release 12.0.3.0.0

**Part No. E53393-01**

April 2014

Gateway Services User Guide  
April 2014  
Oracle Financial Services Software Limited

Oracle Park

Off Western Express Highway  
Goregaon (East)  
Mumbai, Maharashtra 400 063  
India

Worldwide Inquiries:

Phone: +91 22 6718 3000

Fax: +91 22 6718 3001

[www.oracle.com/financialservices/](http://www.oracle.com/financialservices/)

Copyright © 2007, 2014, Oracle and/or its affiliates. All rights reserved.

Oracle and Java are registered trademarks of Oracle and/or its affiliates. Other names may be trademarks of their respective owners.

U.S. GOVERNMENT END USERS: Oracle programs, including any operating system, integrated software, any programs installed on the hardware, and/or documentation, delivered to U.S. Government end users are "commercial computer software" pursuant to the applicable Federal Acquisition Regulation and agency-specific supplemental regulations. As such, use, duplication, disclosure, modification, and adaptation of the programs, including any operating system, integrated software, any programs installed on the hardware, and/or documentation, shall be subject to license terms and license restrictions applicable to the programs. No other rights are granted to the U.S. Government.

This software or hardware is developed for general use in a variety of information management applications. It is not developed or intended for use in any inherently dangerous applications, including applications that may create a risk of personal injury. If you use this software or hardware in dangerous applications, then you shall be responsible to take all appropriate failsafe, backup, redundancy, and other measures to ensure its safe use. Oracle Corporation and its affiliates disclaim any liability for any damages caused by use of this software or hardware in dangerous applications.

This software and related documentation are provided under a license agreement containing restrictions on use and disclosure and are protected by intellectual property laws. Except as expressly permitted in your license agreement or allowed by law, you may not use, copy, reproduce, translate, broadcast, modify, license, transmit, distribute, exhibit, perform, publish or display any part, in any form, or by any means. Reverse engineering, disassembly, or decompilation of this software, unless required by law for interoperability, is prohibited.

The information contained herein is subject to change without notice and is not warranted to be error-free. If you find any errors, please report them to us in writing.

This software or hardware and documentation may provide access to or information on content, products and services from third parties. Oracle Corporation and its affiliates are not responsible for and expressly disclaim all warranties of any kind with respect to third-party content, products, and services. Oracle Corporation and its affiliates will not be responsible for any loss, costs, or damages incurred due to your access to or use of third-party content, products, or services.

---

# Contents

<b>1. Preface .....</b>	<b>1-1</b>
1.1 Introduction.....	1-1
1.2 Audience.....	1-1
1.3 Documentation Accessibility.....	1-1
1.4 Acronyms and Abbreviations.....	1-1
1.5 Organization .....	1-1
1.6 Related Documents .....	1-2
1.7 Glossary of Icons.....	1-2
<b>2. Gateway Functions - An Overview .....</b>	<b>2-1</b>
2.1 Introduction.....	2-1
2.2 Inbound Application Integration .....	2-1
2.2.1 <i>EJB Based Synchronous Deployment Pattern</i> .....	2-1
2.2.2 <i>Web Services Based Synchronous Deployment Pattern</i> .....	2-2
2.2.3 <i>HTTP Servlet Based Synchronous Deployment Pattern</i> .....	2-2
2.2.4 <i>MDB Based Asynchronous Deployment Pattern</i> .....	2-2
2.3 Outbound Application Integration .....	2-3
2.4 Responsibilities of Integration Gateway .....	2-3
2.5 Deployment of Oracle FLEXCUBE Integration Gateway.....	2-3
2.6 Deployment Patterns for Application Integration .....	2-4
2.7 FLEXML Adapter.....	2-4
<b>3. External System Maintenance .....</b>	<b>3-1</b>
3.1 Defining an External System .....	3-1
3.1.1 <i>Specifying External System Details</i> .....	3-1
3.1.2 <i>Indicating Correlation Pattern</i> .....	3-1
3.1.3 <i>Specifying Message Exchange Pattern</i> .....	3-2
3.1.4 <i>Specifying Queue Details</i> .....	3-2
3.1.5 <i>Specifying External System Queue Details</i> .....	3-2
3.1.6 <i>Viewing External System Details</i> .....	3-3
3.1.7 <i>Accessing Services and Operations</i> .....	3-4
3.2 Defining Access Rights to an External System .....	3-4
3.2.1 <i>Viewing External System Function Details</i> .....	3-5
3.2.2 <i>Defining Access Rights to a User ID</i> .....	3-6
3.2.3 <i>Maintaining Upload Source Details</i> .....	3-6
3.2.4 <i>Specifying Upload Source Preferences</i> .....	3-7
3.2.5 <i>Maintaining Function ID Preferences</i> .....	3-8
3.3 Gateway Password Generation Logic For External System Authentication.....	3-9
3.3.1 <i>Password and Message ID as input</i> .....	3-10
3.4 Incoming Message Browser .....	3-10
3.4.1 <i>Viewing Incoming Message Details</i> .....	3-12
3.5 Duplicate Message Browser.....	3-12
3.5.1 <i>Querying Duplicate Message Browser</i> .....	3-14
3.6 Outgoing Message Browser .....	3-15
3.6.1 <i>Querying Outgoing Message Browser</i> .....	3-18
3.7 Defining Notification Messages .....	3-18

3.7.1	Viewing Installed Notification Details.....	3-20
3.8	Defining the Notifications Enroutes .....	3-21
3.8.1	Viewing Summary screen.....	3-22
3.9	Maintaining MT Task Details .....	3-23
<b>4.</b>	<b>Message Formats .....</b>	<b>4-1</b>
4.1	Introduction.....	4-1
4.2	Oracle FLEXCUBE Envelope .....	4-2
4.2.1	FCUBS HEADER .....	4-3
4.2.2	FCUBS_BODY .....	4-5
4.3	Oracle FLEXCUBE NOTIFICATION.....	4-6
4.3.1	FCUBS NOTIFICATION HEADER.....	4-6
<b>5.</b>	<b>FLEXML Adapter Message Conversion .....</b>	<b>5-1</b>
5.1	Introduction.....	5-1
5.2	Inbound FLEXML Adapter .....	5-1
5.2.1	Processing Incoming FLEXML Request Message .....	5-2
5.3	Outbound FLEXML Adapter .....	5-2
5.3.1	Processing Outbound Messages.....	5-2
5.3.2	Mapping FLEXML Format Messages to Gateway Format .....	5-3
<b>6.</b>	<b>Annexure – List of Messages .....</b>	<b>6-1</b>
6.1	Introduction.....	6-1
6.2	Inbound Application Integration – Services .....	6-1
6.2.1	FCUBSFTService .....	6-1
6.2.2	FCUBSAccService .....	6-5
6.2.3	FCUBSDDService .....	6-14
6.2.4	FCUBSLDService.....	6-15
6.2.5	FCUBSCustomerService.....	6-18
6.2.6	FCUBSTDService.....	6-24
6.2.7	FCUBSPCService .....	6-26
6.2.8	FCUBSExtPCService .....	6-29
6.2.9	FCUBSIFService .....	6-31
6.2.10	FCUBSInteractionService .....	6-32
<b>7.</b>	<b>Planned Outage Support Server .....</b>	<b>7-1</b>
7.1	Introduction.....	7-1
7.2	Handling Planned Outages.....	7-1
7.2.1	Host Up.....	7-1
7.2.2	Outage Start .....	7-1
7.2.3	Host Down and POSS Up: .....	7-2
7.2.4	Host Up, Start Replay from POSS:.....	7-2
7.2.5	ELCM Impact.....	7-3
7.3	Services Supported during Outage .....	7-3
7.3.1	FCUBSFT Service .....	7-3
7.3.2	FCUBSPC Service .....	7-3
7.3.3	FCUBSSI Service .....	7-4
7.3.4	FCUBSTD Service.....	7-4
7.3.5	FCUBSCL Service.....	7-4
7.3.6	FCUBSLD Service.....	7-4
7.3.7	FCUBSAcc Service .....	7-4
7.3.8	FCUBS Customer Service.....	7-4
7.3.9	FCUBSIL Service .....	7-4

7.3.10	<i>FCUBSLC Service</i> .....	7-5
7.3.11	<i>FCUBSFX Service</i> .....	7-5
7.3.12	<i>FCUBSCG Service</i> .....	7-5
7.3.13	<i>FCUBSSwitch Service</i> .....	7-5
<b>8.</b>	<b>Function ID Glossary</b> .....	<b>8-1</b>

## 1.1 Introduction

This manual is designed to help you quickly get acquainted with the Integration Gateway of Oracle FLEXCUBE.

It provides an overview to the module, and provides information on using the Integration Gateway module of Oracle FLEXCUBE.

You can further obtain information specific to a particular field by placing the cursor on the relevant field and striking <F1> on the keyboard.

## 1.2 Audience

This manual is intended for the following User/User Roles:

Role	Function
IT department members responsible for integration	Input functions for maintenance related to the gateway
IT managers	Authorization functions

## 1.3 Documentation Accessibility

For information about Oracle's commitment to accessibility, visit the Oracle Accessibility Program website at <http://www.oracle.com/pls/topic/lookup?ctx=acc&id=docacc>.

## 1.4 Acronyms and Abbreviations

Abbreviation	Description
FLEXCUBE UBS	FLEXCUBE Universal Banking Solution

## 1.5 Organization

The manual is organized in the following manner:

<b>Chapter 1</b>	<i>About this Manual</i> gives information on the intended audience. It also lists the various chapters covered in this User Manual.
<b>Chapter 2</b>	<i>Gateway Functions - An Overview</i> explains the features of this module.
<b>Chapter 3</b>	<i>External System Maintenance</i> explains the maintenance of external systems and the various processes involved.
<b>Chapter 4</b>	<i>Message Formats</i> explains the different message formats.
<b>Chapter 5</b>	<i>FLEXML Adapter Message Conversion</i> explains details about the FLEXML Adapter.





<b>Chapter 6</b>	<i>Annexure – List of Messages</i> lists all the messages that you encounter while working with Oracle FLEXCUBE Gateway services.
<b>Chapter 7</b>	<i>Planned Outage Support Server</i> describes the process of having a support server to substitute the host server during downtime.
<b>Chapter 8</b>	<i>Function ID Glossary</i> has alphabetical listing of Function/Screen ID's used in the module with page references for quick navigation.

## 1.6 Related Documents

- The Core Entities User Manual
- The Procedures User Manual
- The Settlements User Manual
- The Profit and Charges User Manual

## 1.7 Glossary of Icons

This User Manual may refer to all or some of the following icons:

<b>Icons</b>	<b>Function</b>
	Exit
	Add row
	Delete row
	Option List

---

## 2. Gateway Functions - An Overview

### 2.1 Introduction

Integration of different applications and solutions is a key area in today's systems. A variety of specialized applications deployed on disparate platforms and using different infrastructure need to be able to communicate and integrate seamlessly with Oracle FLEXCUBE in order to exchange data. The Oracle FLEXCUBE Integration Gateway (referred to as 'Gateway' in the rest of the document) will cater to these integration needs.

The integration needs supported by the Gateway can be broadly categorized from the perspective of the Gateway as follows:

- Inbound application integration – used when any external system needs to add, modify or query information within Oracle FLEXCUBE
- Outbound application integration – used when any external system needs to be notified of the various events that occur within Oracle FLEXCUBE.

### 2.2 Inbound Application Integration

Oracle FLEXCUBE Inbound Application Gateway provides XML based interfaces thus enhancing the need to communicate and integrate with the external systems. The data exchanged between Oracle FLEXCUBE and the external systems will be in the form of XML messages. These XML messages are defined in FCUBS in the form of XML Schema Documents (XSD) and are referred to as 'FCUBS formats'

*For more information on FCUBS formats refer the Message Formats chapter in this User Manual.*

FCUBS Inbound Application Integration Gateway uses the Synchronous and Asynchronous Deployment Pattern for addressing the integration needs.

The Synchronous Deployment Pattern is classified into the following:

- Oracle FLEXCUBE EJB Based Synchronous Inbound Application Integration Deployment Pattern
- Oracle FLEXCUBE Web Services Based Synchronous Inbound Application Integration Deployment Pattern
- Oracle FLEXCUBE HTTP Servlet Based Synchronous Inbound Application Integration Deployment Pattern

Asynchronous Deployment Pattern is:

- Oracle FLEXCUBE MDB Based Asynchronous Inbound Application Integration Deployment Pattern

#### 2.2.1 EJB Based Synchronous Deployment Pattern

The Enterprise Java Beans (EJB) deployment pattern will be used in integration scenarios where the external system connecting to Oracle FLEXCUBE is 'EJB literate', i.e., the external system is capable of interacting with Oracle FLEXCUBE based upon the EJB interface. In this deployment pattern, the external system will use the RMI/IIOP protocol to communicate with the Oracle FLEXCUBE EJB.

In this deployment pattern the EJB displayed by Oracle FLEXCUBE will be a stateless session bean. The actual request will be in the form of an XML message. After the necessary



processing is done in Oracle FLEXCUBE based on the request, the response is returned to the external system as an XML message. The transaction control for the processing will stay with the Oracle FLEXCUBE EJB.

### **2.2.2 Web Services Based Synchronous Deployment Pattern**

The web services deployment pattern will be used in integration scenarios where the external system connecting to Oracle FLEXCUBE wants to connect using standards-based, interoperable web services.

This deployment pattern is especially applicable to systems which meet the following broad guidelines:

- Systems that are not 'EJB literate', i.e., such systems are not capable of establishing connections with Oracle FLEXCUBE based upon the EJB interface; and/or
- Systems that prefer to use a standards-based approach

In this deployment pattern, the external system will use the SOAP (Simple Object Access Protocol) messages to communicate to the Oracle FLEXCUBE web services.

The services displayed by Oracle FLEXCUBE are of a 'message based' style, i.e., the actual request will be in the form of an XML message, but the request will be a 'payload' within the SOAP message. After the necessary processing is done in Oracle FLEXCUBE based on the request, the response is returned to the external system as an XML message which will be a 'payload' within the response SOAP message. The transaction control for the processing will stay with the Oracle FLEXCUBE.

### **2.2.3 HTTP Servlet Based Synchronous Deployment Pattern**

The HTTP servlet deployment pattern will be used in integration scenarios where the external system connecting to Oracle FLEXCUBE wants to connect to Oracle FLEXCUBE using simple HTTP messages.

This is especially applicable to systems such as the following:

- Systems that are not 'EJB literate', i.e., are not capable establishing a connections with Oracle FLEXCUBE based upon the EJB interface; and/or
- Systems that prefer to use a simple http message based approach without wanting to use SOAP as the standard

In this deployment pattern, the external system will make an HTTP request to the Oracle FLEXCUBE servlet.

For this deployment pattern, Oracle FLEXCUBE will display a single servlet. The actual request will be in the form of an XML message. This XML message is embedded into the body of the HTTP request sent to the Oracle FLEXCUBE servlet. After the necessary processing is done in Oracle FLEXCUBE based on the request, the response is returned to the external system as an XML message which is once again embedded within the body of the response HTTP message. The transaction control for the processing will stay with the Oracle FLEXCUBE.

### **2.2.4 MDB Based Asynchronous Deployment Pattern**

The MDB deployment pattern is used in integration scenarios where the external system connecting to Oracle FLEXCUBE wants to connect to Oracle FLEXCUBE using JMS queues.

This is especially applicable to systems such as the following:

- Systems that prefer to use JMS queues based approach without wanting to wait for the reply

Here external system sends messages in XML format to request queue on which an MDB is listening. When a message arrives on the queue, it is picked up for processing. After the necessary processing is done in Oracle FLEXCUBE, based on the request, the response is sent to the response queue as an XML message

## **2.3 Outbound Application Integration**

The Outbound Application Integration is also called the Oracle FLEXCUBE Notify Application Integration layer. This application layer sends out notification messages to the external system whenever events occur in Oracle FLEXCUBE.

The notification messages generated by FCUBS on the occurrence of these events will be XML messages. These XML messages are defined in FCUBS in the form of XML Schema Documents (XSD) and are referred to as 'FCUBS formats'

*For more information on FCUBS formats refer the Message Formats chapter in this module.*

## **2.4 Responsibilities of Integration Gateway**

The primary responsibilities of Oracle FLEXCUBE Integration Gateway include the following:

- Authentication
- Duplicate recognition
- Validation
- Routing
- Logging of messages

## **2.5 Deployment of Oracle FLEXCUBE Integration Gateway**

Message communication - incoming or outgoing from/to an external system in Oracle FLEXCUBE will happen only through an Oracle FLEXCUBE Integration Gateway. Hence, it becomes the first point of contact or last point of contact with the database in message flow. The Oracle FLEXCUBE Integration Gateway can be deployed to support both the distributed and single schema deployments of Oracle FLEXCUBE:

- Distributed deployment of FCUBS – In this situation the database components of the Gateway are deployed as two or more schemas
  - The messaging schema as part of SMS schema in the SMS and/or HO instance
  - The business schema(s) in the various branch schemas in the branch instance(s)
- Single schema deployment of FCUBS – In this situation the database components of the Gateway (messaging and business) are both deployed as part of the single Oracle FLEXCUBE schema.

## 2.6 Deployment Patterns for Application Integration

Business Integration Needs	Nature of Integration	Oracle FLEXCUBE Deployment Pattern	Remarks
Inbound Transactions into Oracle FLEXCUBE	Synchronous	FLEXCUBE UBS EJB	Recommended
		FLEXCUBE UBS HTTP Servlet	This can be used if the external system cannot communicate to Oracle FLEXCUBE using EJB.
		FLEXCUBE UBS Web Services	This can be used if the external system chooses to communicate only through Web Services.
	Asynchronous	FLEXCUBE UBS MDB	This can be used if the external system chooses to communicate only through JMS queues
Inbound Queries into Oracle FLEX-CUBE	Synchronous	FLEXCUBE UBS EJB	Recommended
		FLEXCUBE UBS In Servlet	This can be used if the external system cannot communicate to Oracle FLEXCUBE using EJB.
		FLEXCUBE UBS Web Services	This can be used if the external system chooses to communicate only through Web Services.
	Asynchronous	FLEXCUBE UBS MDB	This can be used if the external system chooses to communicate only through JMS queues
Handoffs from Oracle FLEX-CUBE	Asynchronous	FLEXCUBE UBS Notify	Recommended

## 2.7 FLEXML Adapter

Oracle FLEXCUBE Gateway is the common channel for data exchange between Oracle FLEXCUBE and external systems. But, older versions of Oracle FLEXCUBE use FLEXML Gateway to interact with the external systems. The message or communication format of FLEXML is different from that of the gateway.

Hence, in order to facilitate the exchange of messages between such systems, Oracle FLEXCUBE uses a conversion mechanism called the FLEXML Adapter. FLEXML Adapter converts messages from FLEXML format to gateway format and vice versa.

*For more details on the conversion mechanism of FLEXML Adapter, refer the chapter 'FLEXML Adapter Message Conversion'.*

## 3. External System Maintenance

### 3.1 Defining an External System

You need to define an external system that will communicate with the Oracle FLEXCUBE Integration Gateway.

You can define an external system using the 'External System – Detailed' screen.

You can invoke this screen by typing 'GWDEXSYS' in the field at the top right corner of the Application tool bar and clicking the adjoining arrow button.

The screenshot shows the 'External Systems' configuration window. It includes sections for 'External System', 'Correlation Pattern', 'Message Exchange Pattern', and 'Queue'. The 'External System' section has fields for 'External System \*' and 'Description'. The 'Correlation Pattern' section has a 'Request' dropdown menu set to 'Message Id'. The 'Message Exchange Pattern' section has 'Request Message' set to 'Input Only' and 'Response Message' set to 'Full Screen', with a checkbox for 'XSD Validation Required'. The 'Queue' section has 'Default Response Queue' and 'Dead Letter Queue' text boxes, and a checkbox for 'Register Response Queue Message Id'. Below these is a table titled 'External System Queues' with columns 'In Queue \*' and 'Response Queue'. At the bottom, there are fields for 'Input By', 'Date Time', 'Authorized By', 'Date Time', 'Modification Number', and checkboxes for 'Authorized' and 'Open', along with an 'Exit' button.

The various details required by the 'External System - Detailed' screen are described below.

#### 3.1.1 Specifying External System Details

##### **External System**

Specify a name for the external system. This should be the same as the Source in an incoming message.

##### **Description**

Specify a brief description for the External System.

#### 3.1.2 Indicating Correlation Pattern

##### **Request**

You can define a way in which the external system should correlate its request message with the response message. You can choose Message ID of a request message as the Correlation

ID in the response message. Alternatively, you can choose Correlation ID of a request message and maintain it as the Correlation ID of the corresponding response message.

### 3.1.3 **Specifying Message Exchange Pattern**

#### **Request Message**

You can choose the Request message to be 'Full Screen' or 'Input Only'. If you select 'Full Screen' as the request message, the response message will also display 'Full Screen'.

#### **Response Message**

You can choose the Response message to be 'Full Screen' or 'Record Identification Msg'.

---

#### **Note**

You can select 'Record Identification Msg' as the response message only if you select 'Input Only' in the request message.

---

### 3.1.4 **Specifying Queue Details**

#### **Default Response Queue**

You can define a response queue for each of the In Queue's through which the External System will communicate with Oracle FLEXCUBE. Define a valid queue name as the Default Response Queue.

#### **Dead Letter Queue**

If the messages received are non-readable, such messages are directed to Dead Letter Queue defined for the external system.

---

#### **Note**

If the Dead Letter Queue is not defined, such messages will be redirected to a queue with the name of the request queue appended with '\_E'.

---

#### **XSD Validation Required**

Check this box to indicate if the request message should be validated against its corresponding XSD.

#### **Register Response Queue Message ID**

Check this box to indicate if the message ID provided by the Response Queue should be logged when a response message is posted into the queue.

### 3.1.5 **Specifying External System Queue Details**

The 'External System Queues' list contains the 'In Queue' and 'Response Queue' lists. To add a record to the 'External System Queues' list click add icon. To delete a record from the list, select the record using its check box and then click delete icon.

#### **In Queue**

Specify the name of the queue from which the messages were received. The name of the queue will help identify the external system.

---

#### **Note**

This is required only if an incoming message does not display the source of the message. An In Queue is mapped to only one External System.

---

You can map multiple queues to a source. System will allow a source to post messages to multiple queues.

### Response Queue

You can define Response Queue for every In Queue. This is required only when the External System fails to display the queue name on posting a request message into the In Queue.

## 3.1.6 Viewing External System Details

The details of previously defined external Systems can be viewed using the 'External System - Summary' screen as shown below. You can invoke this screen by typing 'GWSEXSYS' in the field at the top right corner of the Application tool bar and clicking the adjoining arrow button.

The screenshot shows a web application window titled 'Summary'. At the top, there are 'Advanced Search' and 'Reset' buttons. Below are search filters: 'Authorization Status' (dropdown), 'Record Status' (dropdown), 'External System' (text input with a search icon), and 'Dead Letter Queue' (text input with a search icon). A pagination bar shows 'Records per page 15', 'First', 'Previous', '1 Of 1', 'Next', 'Last', and 'Go'. Below the filters is a table with the following columns: 'Authorization Status', 'Record Status', 'External System', 'Default Response Queue', and 'Dead Letter Queue'. The table is currently empty. At the bottom, there are buttons for 'Authoriza', 'Record St', and 'Exit'.

This summary screen can be used to search for external systems which match the data specified for any of the following criteria:

- Authorization Status
- External System
- Dead Letter Queue
- Record Status
- Default Response Queue

The 'Result' list shows the external systems which match your query. The search functions available are:

### Advanced

Click **Advanced** to specify queries with logical operators such as AND, OR and NOT.

### Reset

Click **Reset** to empty the values in the criteria fields, so that you may begin a new search.

## Query

After specifying your search criteria click **Query** to view the list of results which match your search criteria.

## Refresh

Click **Refresh** to refresh the list of results.

### 3.1.7 Accessing Services and Operations

In a message it is mandatory to maintain a list of Service Names and Operation Codes. This information is called Gateway Operations.

A combination of every such Service Name and Operation Code is mapped to a combination of Function ID and Action. Every screen in Oracle FLEXCUBE is linked with a function ID. This information is called Gateway Functions.

You can gain access to an external system using the Gateway Functions. The Function IDs mapped in Gateway Functions should be valid Function IDs maintained in Oracle FLEXCUBE. Hence, for every new Service or Operation being introduced, it is important that you provide data in Gateway Operations and Gateway Functions.

Refer the Message Formats chapter for more information on Services and Operations.

## 3.2 Defining Access Rights to an External System

You can define access rights to an external system using the 'External System Functions – Detailed' screen.

You can invoke this screen by typing 'GWDEXFUN' in the field at the top right corner of the Application tool bar and clicking the adjoining arrow button.

The screenshot shows a software window titled "External System Functions - Detailed". At the top left, there are buttons for "New" and "Enter Query". The main area contains several input fields: "External System \*", "Function \*", "Action \*", "Service Name", and "Operation Code". Each of these fields has a small icon to its right. To the right of these fields is a "Description" field. At the bottom of the window, there is a "Fields" section with three columns: "Input By Date Time", "Authorized By Date Time", and "Modification Number". Below these columns are two checkboxes, "Authorized" and "Open", and an "Exit" button.

In the above screen, you need to specify the following details:



## External System

Select an external system for which you wish to provide access rights. The adjoining option list displays all the external systems you have maintained in the 'External Systems – Detailed' screen.

## Function ID

Select a Function ID from the list of values by clicking the adjoining option list. The function ids are invoked from Gateway Functions.

## Action

Select an action for the external system from the option list provided.

## Service Name

This displays the service name based on the Function ID and Action you select.

## Operation Code

This displays the Operation Code based on the Function ID and Action you select.

### 3.2.1 Viewing External System Function Details

You can view the access rights details which have already been defined using the 'External System Functions - Summary' screen as shown below. You can invoke this screen by typing 'GWSEXFUN' in the field at the top right corner of the Application tool bar and clicking the adjoining arrow button.

Authorization Status	Record Status	External System	Function	Action
----------------------	---------------	-----------------	----------	--------

This summary screen can be used to search for external system functions which match any of the following criteria:

- Authorization Status
- External System
- Record Status
- Action
- Function

The 'Result' list shows the external system functions which match your query. The search functions available are:

### Advanced

Click **Advanced** to specify queries with logical operators such as AND, OR and NOT.

### Reset

Click **Reset** to empty the values in the criteria fields, so that you may begin a new search.

### Query

After specifying your search criteria click **Query** to view the list of results which match your search criteria.

### Refresh

Click **Refresh** to refresh the list of results.

## 3.2.2 Defining Access Rights to a User ID

For a User ID to access a request message, you can individually map each Function ID to a User ID.

---

### Note

You can provide access to functions only if the Function IDs provided in Gateway Functions are valid.

---

## 3.2.3 Maintaining Upload Source Details

Oracle FLEXCUBE facilitates upload of data from an external source. The details of the source from which data has to be uploaded need to be maintained in Oracle FLEXCUBE using the 'Upload Source Maintenance' screen. You can invoke the 'Upload Source Maintenance' screen by typing 'CODSORCE' in the field at the top right corner of the Application tool bar and clicking the adjoining arrow button.

The screenshot shows the 'Upload Source Definition' application window. The window title is 'Upload Source Definition'. It contains a 'New' button and an 'Enter Query' button. The main area has a 'Source Code \*' text box, a 'Description' text box with a help icon, and two checkboxes: 'Base Data From FLEXCUBE' and 'System Authorization Required'. At the bottom, there is a 'Fields' section with columns for 'Input By Date Time', 'Authorized By Date Time', and 'Modification Number'. Below these are checkboxes for 'Authorized' and 'Open'.

The following details need to be captured here:

### Source Code

Specify a code for the for the source from which data has to be uploaded to Oracle FLEXCUBE.

### Description

Give a small description for the source code specified.

### Base Data From FLEXCUBE

Check this box to indicate if base data has to be uploaded from Oracle FLEXCUBE.

## 3.2.4 Specifying Upload Source Preferences

You can set preferences for upload of data from an external source in the 'Upload Source Preferences Maintenance' screen. You can invoke the 'Upload Source Preferences Maintenance' screen by typing 'CODUPLDM' in the field at the top right corner of the Application tool bar and clicking the adjoining arrow button.

The screenshot shows the 'Upload Source Preferences Maintenance' window. It has a menu bar with 'New' and 'Enter Query'. The main area is divided into sections: 'Error Handling' with fields for 'Source Code \*', 'Module Code \*', and 'On Exception \*' (set to 'Reject'), and 'On Override \*' (set to 'Ignore'). The 'Post Upload' section includes a 'Status \*' dropdown (set to 'Authorized') and a 'Purge Days(Calendar)' field. Below these are three unchecked checkboxes: 'Allow Deferred Processing', 'Allow EOD with Deferred', and 'Allow Delete'. The bottom of the window features a 'Fields | Function Id Preferences' section with columns for 'Input By', 'Authorized By', and 'Modification Number', each with a 'Date Time' field. There are also checkboxes for 'Authorized' and 'Open', and an 'Exit' button.

The following details are captured here:

### Source Code

Select Source Code from the option list. Depending on the source code you select here data is uploaded from that source into Oracle FLEXCUBE.

### Module Code

You can choose to upload data from a source directly onto a module in FLEXCUBE. Indicate the module into which you would like to upload data from a given source.

### On Override

Oracle FLEXCUBE generates override messages in case it encounters any discrepancies during data upload. You can choose to do any of the following:

- Ignore – Select this option to ignore such error messages and continue with the upload process

- Put on Hold – Select this option to put the record on hold for user intervention later
- Reject – Select this option to reject the record

### On Exception

In case a serious error occurs during data upload, Oracle FLEXCUBE generates an error message. You can choose to put the record with the error on hold. In such a case, choose 'Put on Hold' from the list of options available. If you would like to reject the record altogether, choose 'Reject'.

### Post Upload Status

If you would like to automatically authorize the data that is uploaded into Oracle FLEXCUBE choose the 'Authorize' option here.

If you would like the record to be put on hold choose this option in this field.

If you would like the record to be unauthorized, choose the 'Unauthorized' option in this field. The record will not be authorized automatically on upload. You will have to manually authorize the data.

### Purge Days (Calendar)

Specify the days maintained for purging of the data uploaded.

### Allow Deferred Processing

Check this option to defer processing of amendment and cancellation uploads.

### Allow EOD with Deferred

Check this option to proceed even if the records exist in the deferred processing log.

If it is unchecked, then the EOD process halts until the deferred process log is cleared.

### Allow Delete

Check this option to delete the process log.

## 3.2.5 Maintaining Function ID Preferences

Click 'Function ID Preferences' button in the 'Upload Source Preferences Maintenance' screen.

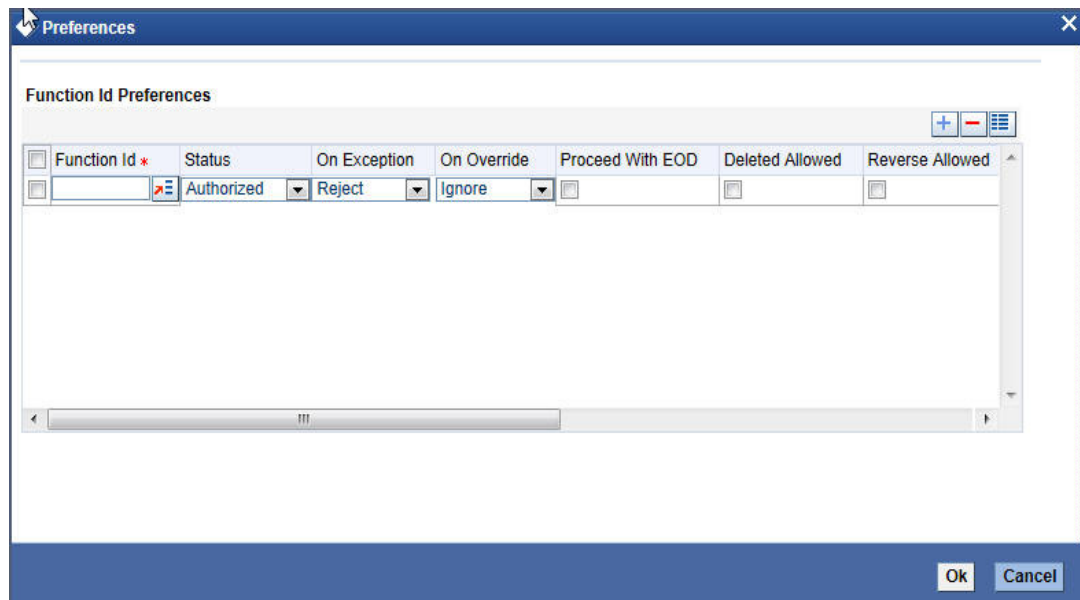

You can enter the following details:

**Function Id**

Specify the function ID. The adjoining option list displays all the function IDs maintained in the system. Select the appropriate one.

**Status**

Select the status of the record from the drop-down list and the available options are:

- Authorized
- Unauthorized
- Put On hold

**On Exception**

Select the record status in case of any exception while saving from the drop-down list and the available options are:

- Put On Hold
- Reject

**On Override**

Select the record status in case of any overriding a saved record from the drop-down list and the available options are:

- Put On Hold
- Reject
- Ignore

**Proceed With EOD**

Check this box, if you wish to proceed with EOD.

**Deleted Allowed**

Check this box, if deleting is allowed.

**Reverse Allowed**

Check this box, if reversal is allowed.

**Amend Allowed**

Check this box, if amendment is allowed.

**Purge Days (Calendar)**

Specify the calendar purge days

**Allow Deferred Processing**

Check this box, if deferred processing is allowed.

**Allow EOD with Deferred**

Check this box, if EOD with deferred is allowed.

### **3.3 Gateway Password Generation Logic For External System Authentication**

This section describes the Encryption information for gateway authentication.

If Password authentication is required for an external system, then check the 'System Authentication Required' check box while maintaining the External System details in CODSORCE.

Once this check box is checked Oracle FLEXCUBE validates for Encrypted password as part of every request sent by the External System. The password encryption logic as below:

### 3.3.1 Password and Message ID as input

Message ID, present as part of the header in Request XML, is considered as hash. External System generates an unique Message ID, which is functional mandatory field in the header. Create a Message Digest with SHA-512 algorithm.

The hash created from the previous step and the password in clear text together is encrypted in DESede encryption method. Apply Base64 encoding to encrypted value and send to the Oracle FLEXCUBE gateway.

## 3.4 Incoming Message Browser

The messages received from the external system will be displayed in the Incoming Message Browser.

You can invoke the 'Incoming Message Browser' screen by typing 'GWDINBRW' in the field at the top right corner of the Application tool bar and clicking the adjoining arrow button.

Message Reference	Level Number	Tag Id	Tag Name	Node	Parent Id	P:
-------------------	--------------	--------	----------	------	-----------	----

In the 'Incoming Message Browser' screen you can view the details of the messages received from the external systems. You can also view the messages in the XML format or the Text format.

Click 'Text View' button to view the incoming messages in text format as shown below:

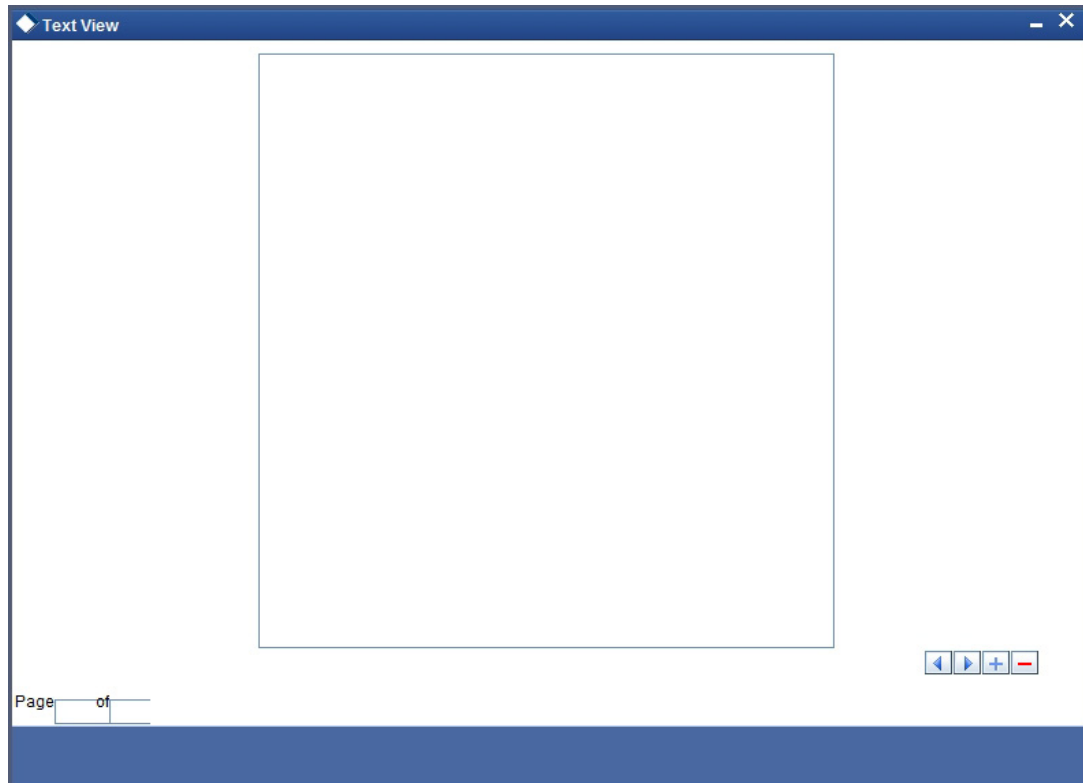

Click 'XML View' button to view the 'Gateway Browser Window' screen which displays the messages in XML format.

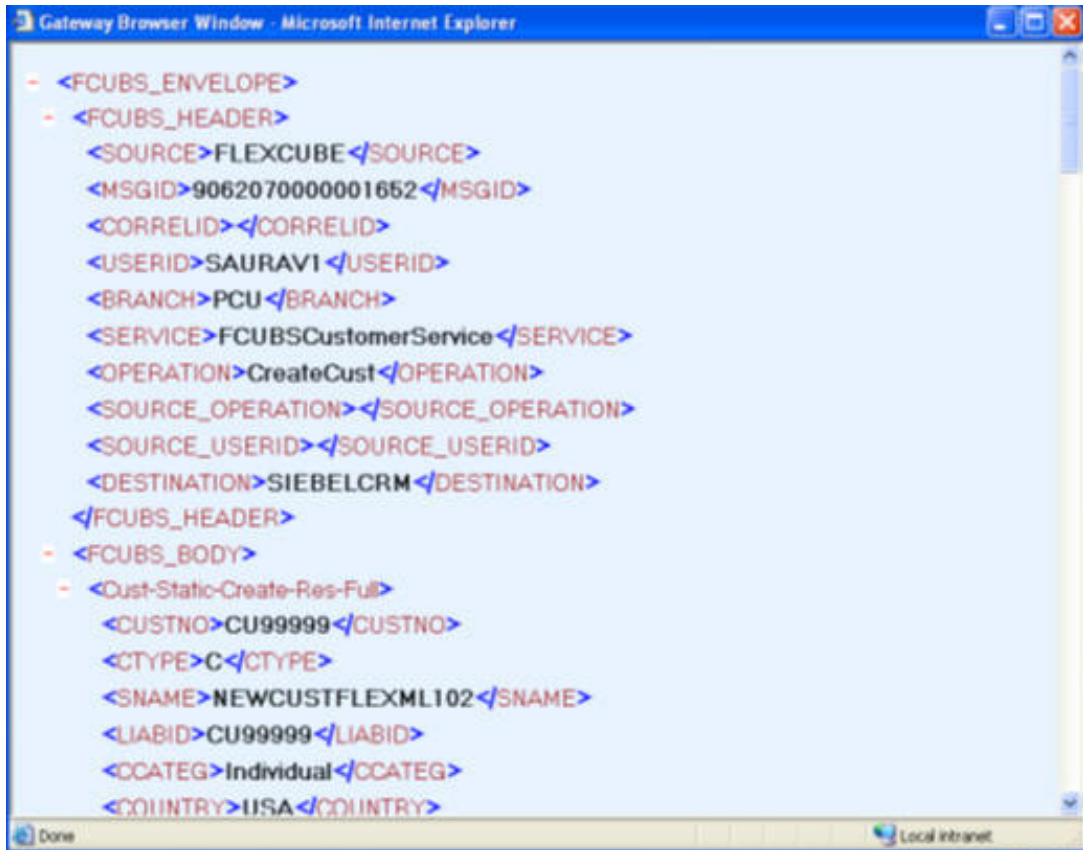

### 3.4.1 Viewing Incoming Message Details

The summary of all messages received from the external system can be viewed using the 'Incoming Message Browser - Summary' screen as shown below. You can invoke this screen by typing 'GWSINBRW' in the field at the top right corner of the Application tool bar and clicking the adjoining arrow button.

The screenshot shows a web application window titled "Summary". At the top, there are "Advanced Search" and "Reset" buttons. Below these are two columns of search criteria, each with a text input field and a small icon (a red arrow pointing right and a list icon). The left column includes: Message Reference, External System, Correlation Id, Service Name, User Id, Branch Date (with a calendar icon), and Message Status. The right column includes: Branch, Message Id, Request Queue Message Id, Operation Code, Their User Id, Server Date Stamp (with a calendar icon), and FLEXCUBE Reference. Below the search fields is a pagination bar with "Records per page" set to 15, and buttons for "First", "Previous", "1 Of 1", "Next", "Last", and "Go". Below the pagination bar is a table header with columns: Message Reference, Branch, External System, Message Id, Correlation Id, Request Queue Message Id, Service Name, Operation Code, and Us. The table body is currently empty. At the bottom right of the window is an "Exit" button.

This summary screen can be used to search for incoming messages which match the criteria (Message Reference Number, External System, Service Name etc) you specify. The 'Result' list shows the messages which match your query. The search functions available are:

#### **Advanced**

Click **Advanced** to specify queries with logical operators such as AND, OR and NOT.

#### **Reset**

Click **Reset** to empty the values in the criteria fields, so that you may begin a new search.

#### **Query**

After specifying your search criteria click **Query** to view the list of results which match your search criteria.

#### **Refresh**

Click **Refresh** to refresh the list of results.

## 3.5 Duplicate Message Browser

If Oracle FLEXCUBE Integration Gateway identifies a duplicate message it will be sent to the Duplicate Messages Browser. You can invoke the 'Duplicate Message Browser - Summary'



screen by typing 'GWSPBROW' in the field at the top right corner of the Application tool bar and clicking the adjoining arrow button.

Summary

Advanced Search Reset

Message Reference

External System

Correlation Id

Service Name

User Id

Server Date Stamp

Branch

Message Id

Request Queue Message Id

Operation Code

Their User Id

Status

Records per page 15 First Previous 1 Of 1 Next Last  Go

Message Reference	Branch	External System	Message Id	Correlation Id	Request Queue Message Id	Service Name	Operation Code	Us
-------------------	--------	-----------------	------------	----------------	--------------------------	--------------	----------------	----

Exit

Click 'Text View' button in the 'Duplicate Message Browser - Summary' screen to view the duplicate messages in the text format.

Duplicate Message Browser - Text View

Page  of

Click 'XML View' button in the 'Duplicate Message Browser - Summary' screen to view the duplicate messages in the following format:

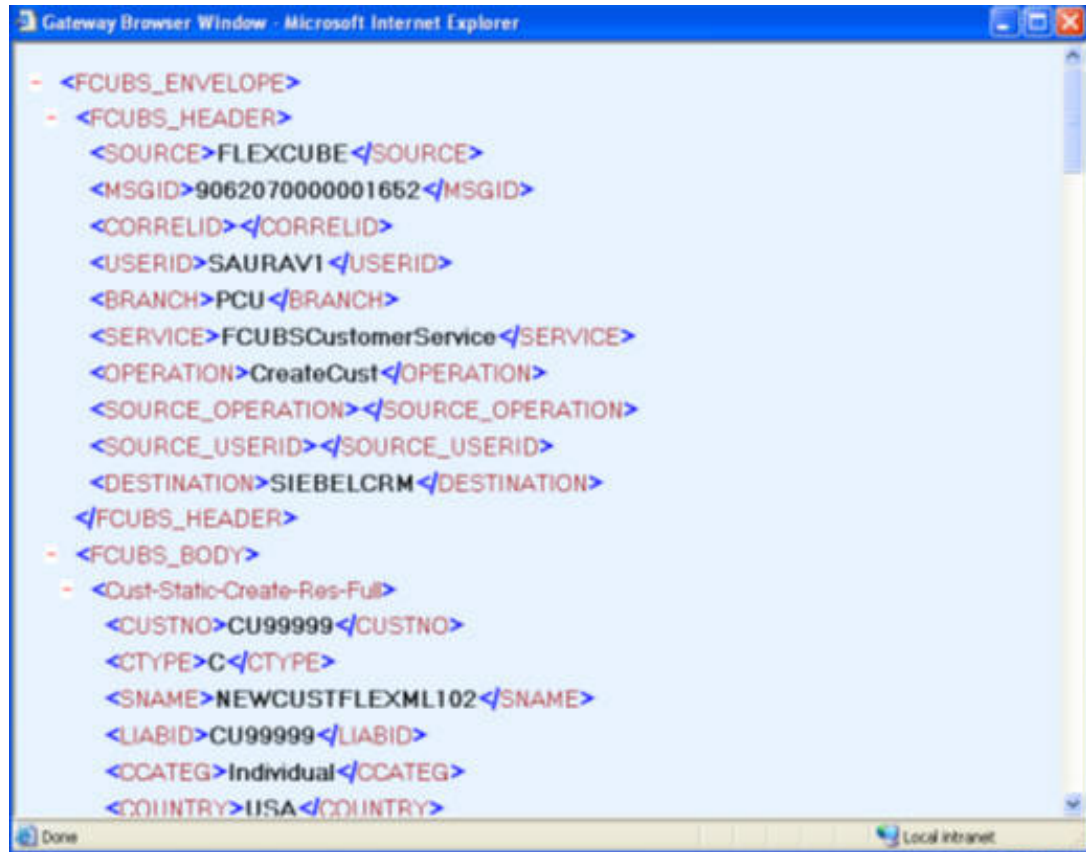

The screenshot shows a web browser window titled 'Gateway Browser Window - Microsoft Internet Explorer'. The main content area displays an XML message structure with the following elements:

```
- <FCUBS_ENVELOPE>
- <FCUBS_HEADER>
  <SOURCE>FLEXCUBE </SOURCE>
  <MSGID>9062070000001652 </MSGID>
  <CORRELID></CORRELID>
  <USERID>SAURAVI </USERID>
  <BRANCH>PCU </BRANCH>
  <SERVICE>FCUBSCustomerService </SERVICE>
  <OPERATION>CreateCust </OPERATION>
  <SOURCE_OPERATION></SOURCE_OPERATION>
  <SOURCE_USERID></SOURCE_USERID>
  <DESTINATION>SIEBELCRM </DESTINATION>
</FCUBS_HEADER>
- <FCUBS_BODY>
- <Cust-Static-Create-Res-Full>
  <CUSTNO>CU99999 </CUSTNO>
  <CTYPE>C </CTYPE>
  <SNAME>NEWCUSTFLEXML102 </SNAME>
  <LIABID>CU99999 </LIABID>
  <CCATEG>Individual </CCATEG>
  <COUNTRY>USA </COUNTRY>
```

The browser's status bar at the bottom shows 'Done' on the left and 'Local intranet' on the right.

### 3.5.1 Querying Duplicate Message Browser

You can query the list of duplicate messages using the 'Duplicate Message Browser - Summary' screen with functions for search. You can invoke this screen by typing

'GWSPBROW' in the field at the top right corner of the Application tool bar and clicking the adjoining arrow button.

The screenshot shows a web application window titled 'Summary'. At the top, there are 'Advanced Search' and 'Reset' buttons. Below these are two columns of search criteria fields, each with a dropdown arrow icon: Message Reference, External System, Correlation Id, Service Name, User Id, Server Date Stamp, Branch, Message Id, Request Queue Message Id, Operation Code, Their User Id, and Status. Below the fields is a pagination control showing 'Records per page 15', 'First', 'Previous', '1 Of 1', 'Next', 'Last', and 'Go' buttons. Below the pagination is a table header with columns: Message Reference, Branch, External System, Message Id, Correlation Id, Request Queue Message Id, Service Name, Operation Code, and Us. At the bottom right of the window is an 'Exit' button.

This query screen can be used to search for duplicate messages which match the criteria (Message Reference Number, External System, Service Name etc) you specify. The 'Result' list shows the messages which match your query. The search functions available are:

#### **Advanced**

Click **Advanced** to specify queries with logical operators such as AND, OR and NOT.

#### **Reset**

Click **Reset** to empty the values in the criteria fields, so that you may begin a new search.

#### **Query**

After specifying your search criteria click **Query** to view the list of results which match your search criteria.

#### **Refresh**

Click **Refresh** to refresh the list of results.

## **3.6 Outgoing Message Browser**

Once the incoming messages have been processed, a response message will be sent to the external systems along with the status of the processed messages. The response messages will be displayed in the 'Outgoing Message Browser'. You can invoke the 'Outgoing Message

Browser' screen by typing 'GWDOTBRW' in the field at the top right corner of the Application tool bar and clicking on the adjoining arrow button.

In the 'Outgoing Message Browser' screen you can view the details of the messages sent to the external systems. You can also view the messages in the XML format or the Text format.

Click 'Text View' button to view the response message in text format as shown below:

Click 'XML View' button to view the response messages in XML format as shown below:

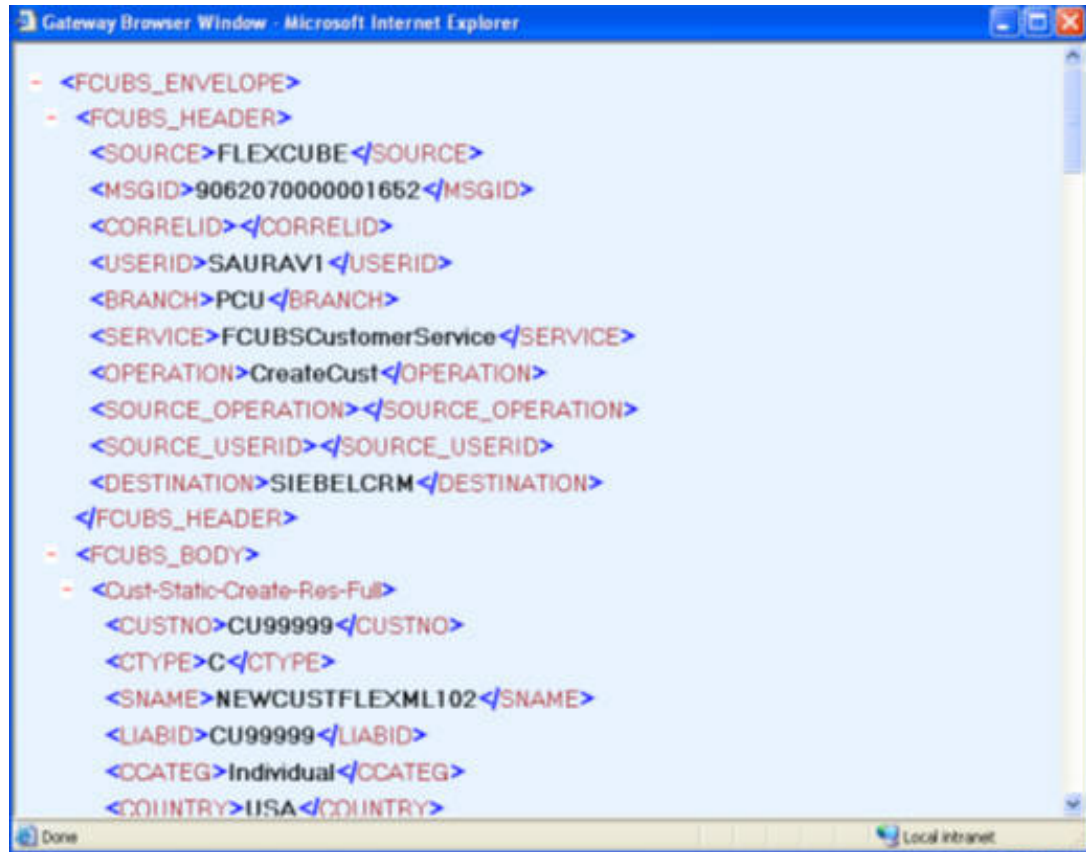

```
- <FCUBS_ENVELOPE>
- <FCUBS_HEADER>
  <SOURCE>FLEXCUBE </SOURCE>
  <MSGID>9062070000001652 </MSGID>
  <CORRELID></CORRELID>
  <USERID>SAURAVI </USERID>
  <BRANCH>PCU </BRANCH>
  <SERVICE>FCUBSCustomerService </SERVICE>
  <OPERATION>CreateCust </OPERATION>
  <SOURCE_OPERATION></SOURCE_OPERATION>
  <SOURCE_USERID></SOURCE_USERID>
  <DESTINATION>SIEBELCRM </DESTINATION>
</FCUBS_HEADER>
- <FCUBS_BODY>
- <Cust-Static-Create-Res-Full>
  <CUSTNO>CU99999 </CUSTNO>
  <CTYPE>C </CTYPE>
  <SNAME>NEWCUSTFLEXML102 </SNAME>
  <LIABID>CU99999 </LIABID>
  <CCATEG>Individual </CCATEG>
  <COUNTRY>USA </COUNTRY>
```

### 3.6.1 Querying Outgoing Message Browser

You can query the list of outgoing messages using the 'Outgoing Message Browser - Summary' screen. You can invoke this screen by typing 'GWSOTBRW' in the field at the top right corner of the Application tool bar and clicking the adjoining arrow button.

The screenshot shows a web application window titled 'Summary'. At the top, there are 'Advanced Search' and 'Reset' buttons. Below these are two columns of search criteria, each with a text input field and a search icon (magnifying glass with a list symbol). The left column includes: Message Reference, Related Message Reference, Service Name, Message Id, Response Queue Message Id, Their User Id, and Server Date Stamp. The right column includes: Branch, External System, Operation Code, Correlation Id, User Id, Branch Date, and Message Status. Below the search fields is a navigation bar with 'Records per page' set to 15, and buttons for 'First', 'Previous', 'Next', 'Last', and 'Go'. Below the navigation bar is a table header with columns: Message Reference, Branch, Related Message Reference, External System, Service Name, Operation Code, Message Id, Correlation Id, and Re. At the bottom right of the window is an 'Exit' button.

This query screen can be used to search for outgoing messages which match the criteria (Message Reference Number, External System, Service Name etc) you specify. The 'Result' list shows the messages which match your query. The search functions available are:

#### Advanced

Click **Advanced** to specify queries with logical operators such as AND, OR and NOT.

#### Reset

Click **Reset** to empty the values in the criteria fields, so that you may begin a new search.

#### Query

After specifying your search criteria click **Query** to view the list of results which match your search criteria.

#### Refresh

Click **Refresh** to refresh the list of results.

## 3.7 Defining Notification Messages

The outgoing message browser also displays the notification messages. Every time the database layer receives a notification message, it updates the outgoing message browser to display the same.

At the branch level, you can maintain notification codes for each branch. You can do this using the 'Notifications Installed' screen.

You can invoke the 'Notifications Installed – Detailed' screen by typing 'GWDNTFIN' in the field at the top right corner of the Application tool bar and clicking the adjoining arrow button.

The screenshot shows a software window titled "Notifications Installed". At the top, there is a toolbar with "New" and "Enter Query" buttons. The main area contains four input fields: "Branch Code \*" and "Notification Code \*" on the left, and "Branch Name" and "Description" on the right. The "Branch Code \*" and "Notification Code \*" fields have dropdown arrows. The "Branch Name" and "Description" fields have help icons. At the bottom, there is a "Fields" section with labels for "Input By Date Time", "Authorized By Date Time", and "Modification Number". Below these are checkboxes for "Authorized" and "Open", and an "Exit" button.

In this screen, you need to specify the following details:

#### **Branch Code**

Select a branch code for which you wish to assign a notification code. Once you select the branch code, the corresponding description is displayed.

#### **Notification Code**

From the list of values, select a notification code you wish to link with the branch. This will be used to generate notifications for the entire branch. Once you select the notification code, the corresponding description is displayed.

In addition to maintaining a notification code for a given branch, you can also specify a topic or a queue to which the notification messages should be sent.

You can define a topic/queue for a given branch and notification code in the 'Notifications Enroute' screen.

### 3.7.1 Viewing Installed Notification Details

You can view and query the list of notification messages using the 'Notifications Installed - Summary' screen. You can invoke this screen by typing 'GWSNTFIN' in the field at the top right corner of the Application tool bar and clicking the adjoining arrow button.

The screenshot shows a web application window titled "Summary". At the top, there are "Advanced Search" and "Reset" buttons. Below these are four search criteria: "Authorization Status", "Record Status", "Branch Code", and "Notification Code", each with a dropdown or input field. A pagination bar indicates "Records per page" is 15, and there is one record displayed ("1 Of 1"). The table below has columns for "Authorization Status", "Record Status", "Branch Code", and "Notification Code". At the bottom of the window, there are buttons for "Authorizal", "Record St", and "Exit".

This summary screen can be used to search for notification messages which match the criteria (Message Reference Number, External System, Service Name etc) you specify. The 'Result' list shows the messages which match your query. The search functions available are:

#### Advanced

Click **Advanced** to specify queries with logical operators such as AND, OR and NOT.

#### Reset

Click **Reset** to empty the values in the criteria fields, so that you may begin a new search.

#### Query

After specifying your search criteria click **Query** to view the list of results which match your search criteria.

#### Refresh

Click **Refresh** to refresh the list of results.



## 3.8 Defining the Notifications Enroutes

You can invoke the 'Notification Enroutes - Detailed' screen by typing 'GWDNTFEN' in the field at the top right corner of the Application tool bar and clicking the adjoining arrow button.

The screenshot shows the 'Notifications En route' application window. The window title is 'Notifications En route'. The interface includes a top menu bar with 'New' and 'Enter Query' options. The main area contains two columns of input fields. The left column has 'Branch Code \*', 'Description', and 'Destination Name \*'. The right column has 'Notification Code \*' and 'Description'. Below the input fields is a 'Fields' section with a blue background, containing 'Input By Date Time', 'Authorized By Date Time', 'Modification Number', and two checkboxes labeled 'Authorized' and 'Open'. An 'Exit' button is located in the bottom right corner of the 'Fields' section.

In 'Notification Enroutes - Detailed' screen, you define the following details:

### **Branch**

Specify a branch for which you wish to define a topic. If you want to use a single topic for all branches and for a given notification code, you can use a wildcard '\*\*\*'. Once you select a Branch Code, the corresponding description is displayed.

### **Notification Code**

Select a notification code from the list of notification codes provided. You can indicate a wildcard '\*\*\*' if a single topic needs to be used for all notifications in a branch.

### **Topic/Queue Name**

Define a topic or a queue here. If you define a topic, you can assign multiple notification codes for a branch. In case of a queue, you can define only one notification code for each branch.

### 3.8.1 Viewing Summary screen

You can view and query the list of notifications enroute using the 'Notifications Enroutes - Summary' screen. You can invoke this screen by typing 'GWSNTFEN' in the field at the top right corner of the Application tool bar and clicking the adjoining arrow button.

Summary

Advanced Search Reset

Authorization Status  Record Status

Branch Code  Notification Code

Destination Name

Records per page 15 First Previous 1 Of 1 Next Last  Go

Authorization Status	Record Status	Branch Code	Notification Code	Destination Name
----------------------	---------------	-------------	-------------------	------------------

Authoriza  
Record St  
Exit

This summary screen can be used to search for notifications enroute which match the criteria (Message Reference Number, External System, Service Name etc) you specify. The 'Result' list shows the messages which match your query. The search functions available are:

#### Advanced

Click **Advanced** to specify queries with logical operators such as AND, OR and NOT.

#### Reset

Click **Reset** to empty the values in the criteria fields, so that you may begin a new search.

#### Query

After specifying your search criteria click **Query** to view the list of results which match your search criteria.

#### Refresh

Click **Refresh** button to refresh the list of results.

## 3.9 Maintaining MT Task Details

Using the 'Gateway Maintenance Detailed' screen, you can maintain the basis for creation of MT tasks for Gateway message. You can invoke this screen by typing 'STDGWINT' in the field at the top right corner of the Application tool bar and clicking the adjoining arrow button.

The screenshot shows the 'Gateway Maintenance' application window. At the top, there is a toolbar with 'New' and 'Enter Query' buttons. Below the toolbar, the main area contains three input fields: 'Branch Code \*', 'External System \*', and 'Module Code \*'. A navigation bar indicates '1 Of 1' records. Below the navigation bar is a table with the following columns: 'Service Name \*', 'Operation Code \*', 'Task Initiation Required', and 'Effective Date'. The bottom section of the window contains fields for 'Maker', 'Checker', 'Mod No', 'Date Time', 'Record Status', and 'Authorization Status', along with an 'Exit' button.

In this screen, you can specify the following details:

### Branch Code

Specify the branch code of the bank. This adjoining option list displays all valid branches maintained in the system. You can choose the appropriate one.

### External System

Specify the name of the external system. This adjoining option list displays all the external systems maintained in the system. You can choose the appropriate one.

### Module Code

Specify the module name. This adjoining option list displays all the modules maintained in the system. You can choose the appropriate one.

### Service Name

Specify the service name of the module selected. This adjoining option list displays all the service names maintained in the system. You can choose the appropriate one.

### Operation code

Specify the operation code of the service. This adjoining option list displays all valid operation codes maintained in the system. You can choose the appropriate one.

### Effective Date

Specify the date from which the gateway message maintenance becomes effective. Effective date should be equal to or greater than the application date.

# 4. Message Formats

## 4.1 Introduction

Data exchanged between Oracle FLEXCUBE and the external systems will be in the form of XML messages. These XML messages are defined in FCUBS in the form of XML Schema Documents (XSD) and are referred to as 'FCUBS formats'. An XML Schema is uniquely identified by its Namespace and its Root Element (root node). The root node for XSDs of gateway messages will be generated as per the following pattern:

- <OPERATION>\_<MESSAGE EXCHANGE PATTERN>\_REQ
- <OPERATION>\_<MESSAGE EXCHANGE PATTERN>\_RES
- Where
- <OPERATION> refers to an Oracle FLEXCUBE operation like CREATECUSTACC
- <MESSAGE\_EXCHANGE\_PATTERN> refers to the request & response message patterns exchanged. The Message Pattern is of the following types
  - FS (Full Screen) - This indicates that the payload will contain all the elements on the corresponding Oracle FLEXCUBE screen.
  - IO (Input Only) - This indicates that the payload will contain the only input elements on the corresponding Oracle FLEXCUBE screen.
  - PK (Primary Key): This indicates that the payload will contain only the Primary Key elements of the corresponding Oracle FLEXCUBE screen.

<MESSAGE\_EXCHANGE\_PATTERN> is a combination of message patterns. The <MESSAGE\_EXCHANGE\_PATTERN> available in FLEXCUBE is shown below:

- FSFS - Full Screen Request and Full Screen Response
- IOPK - Input Only Request and Primary Key Response
- IOFS - Input Only Request and Full Screen Response

### Non-Query Formats

For example, consider the Operation 'CREATECUSTACC'. The root node of messages under this operation will be as under:

- CREATECUSTACC\_FSFS\_REQ

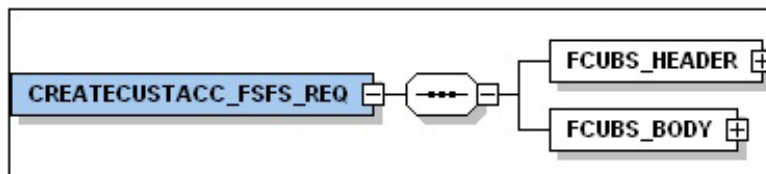

- CREATECUSTACC\_FSFS\_RES

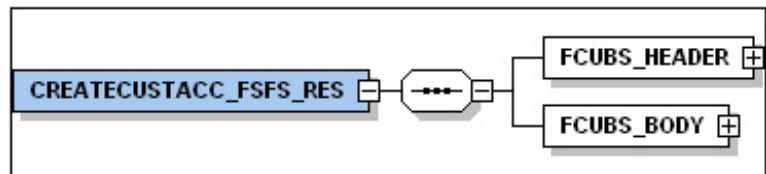

- CREATECUSTACC\_IOPK\_REQ

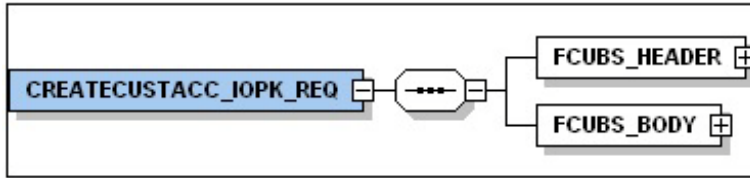

- CREATECUSTACC\_IOPK\_RES

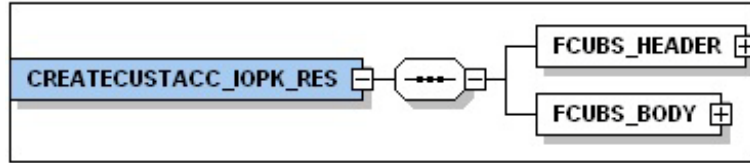

### **Query Formats**

For example, consider the Operation 'QUERYCUSTACC'. The root node of messages under this operation will be as under:

- QUERYCUSTACC\_IOFS\_REQ

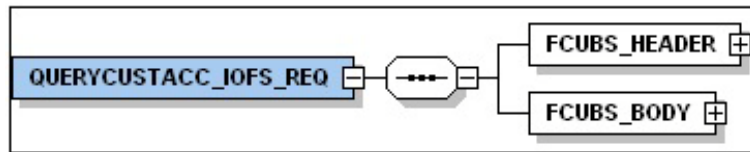

- QUERYCUSTACC\_IOFS\_RES

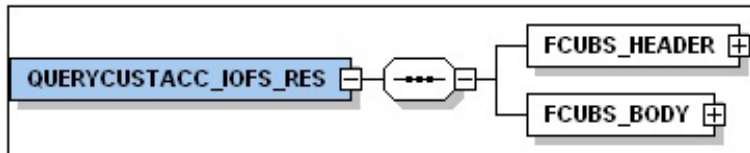

## **4.2 Oracle FLEXCUBE Envelope**

A standard gateway message in the Oracle FLEXCUBE Envelope contains two main components namely:

- FCUBS\_HEADER – This is a node that forms the header of the FCUBS Envelope. The tags under the header portion of a message will identify a partner system, a service, an operation, user, branch, etc. These tags are constant across all messages.

- FCUBS\_BODY – This node contains the actual payload of a message. The contents of this node will vary for each message.

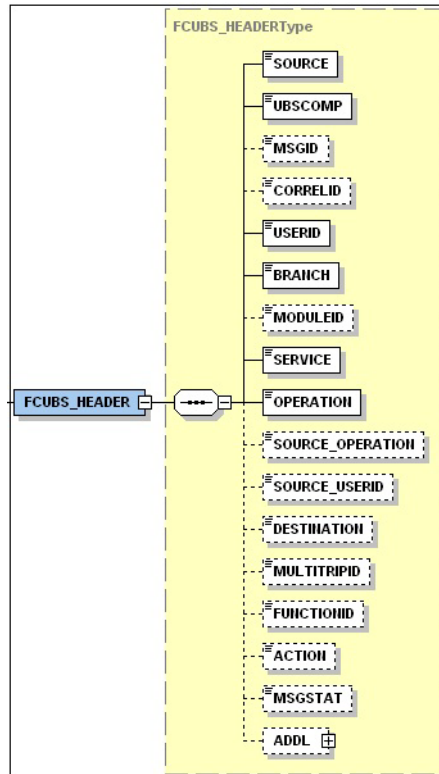

#### 4.2.1 **FCUBS HEADER**

The tags under FCUBS HEADER have been described below:

##### **SOURCE**

This indicates the name of the External system that is the source of the message.

##### **UBSCOMP**

This indicates the Oracle FLEXCUBE component of the message - whether FCIS or FCUBS

##### **MSGID**

This unique ID identifies each message – incoming or outgoing in Oracle FLEXCUBE. Every message will have a distinct message ID.

**CORRELID**

This is the id using which any system which has sent a request to FC UBS can correlate to the response. In the External system maintenance, the Correlation Pattern can be configured for each external system. It can be maintained that either the 'MSGID' or the 'CORRELID' of the request message is returned back as the 'CORRELID' in the response message. Depending on this maintenance, Oracle FLEXCUBE will set either the 'MSGID' or the 'CORRELID' of the request message in the response message.

**USERID**

For request messages, this ID is used to submit message requests. Oracle FLEXCUBE will process this request using this id.

For response messages, the value of this will be 'null'.

**BRANCH**

This indicates the Oracle FLEXCUBE Branch Code where the request message needs to be processed. If the BRANCH is missing in the header, request message will be transmitted and processed in Head Office branch.

**MODULEID**

This indicates the module ID.

**SERVICE**

This provides details on the various services of Oracle FLEXCUBE. For every incoming message in Oracle FLEXCUBE, the service name is mandatory.

**OPERATION**

This indicates the functional operation.

**SOURCE\_OPERATION**

This indicates the functional operation as registered in Oracle FLEXCUBE.

**SOURCE\_USERID**

This is the User ID with which the request message was invoked from the SOURCE.

**DESTINATION**

For incoming messages, the destination will be Oracle FLEXCUBE. For response messages, system will populate the SOURCE of the request message as DESTINATION.

**MULTIRIPID**

This is a unique id which indicates overrides.

**FUNCTIONID**

This indicates the Oracle FLEXCUBE Function ID

**MSGSTAT**

This indicates whether the transaction is a SUCCESS or FAILURE.

**ADDL**

This is used to send additional parameters i.e. parameters not available in Oracle FLEXCUBE.

## 4.2.2 FCUBS\_BODY

The FCUBS\_BODY will contain the actual payload to perform the respective transaction. The contents of the payload will vary for each operation.

The following snapshot shows a sample FCUBS\_BODY of QUERYCUSTACC operation.

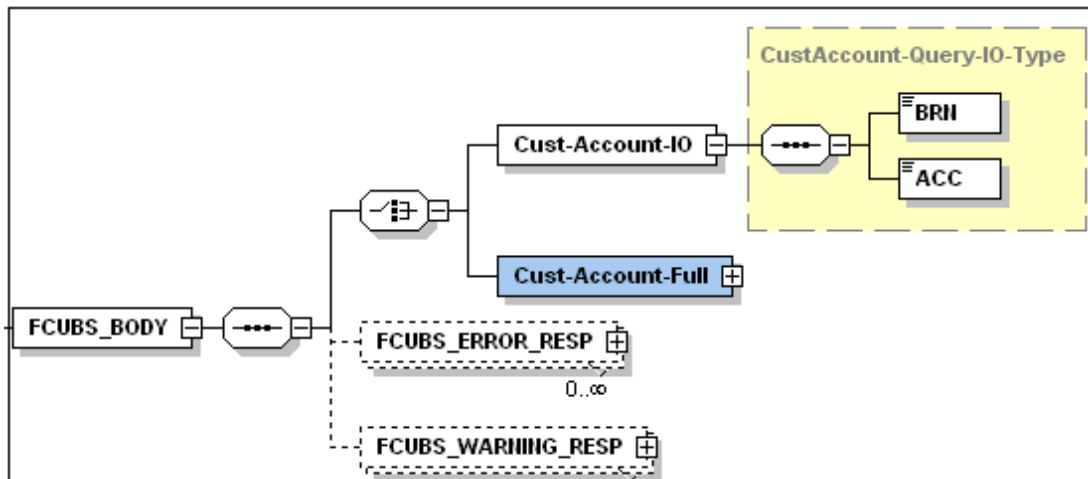

FCUBS\_BODY will contain additional nodes for error response and warning response. A diagrammatic representation of the Error response is as shown below:

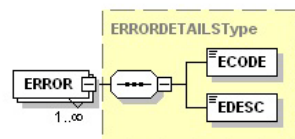
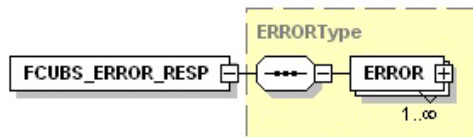

### 4.2.2.1 FCUBS\_ERROR\_RESP

The error response message will be sent from Oracle FLEXCUBE when errors are raised in a transaction. The error response will have another tag 'ERROR' within it.

#### ERROR

The 'ERROR' node will have tags for error code and error description. The 'ERROR' node will be generated for each error raised by FCUBS.

### 4.2.2.2 FCUBS\_WARNING\_RESP

The warning response message will be sent when overrides are raised in a transaction. The Warning response will have another tag 'WARNING' within it.



## WARNING

This node will have tags for warning code and warning description. The 'WARNING' node will be generated for each override raised by FCUBS.

## 4.3 Oracle FLEXCUBE NOTIFICATION

The notification messages are generated in a standard format. The notification messages will consist of two main components:

**FCUBS\_NOTIF\_HEADER** – This forms the header portion of a notification message. This contains a standard set of tags that can identify a notification. These tags are constant across all notification messages.

**FCUBS\_NOTIF\_IDENTIFIER** – This will identify the maintenance records based on the information provided under this node. The contents of this node will vary for each notification.

A diagrammatic representation of FCUBS NOTIFICATION is as shown below:

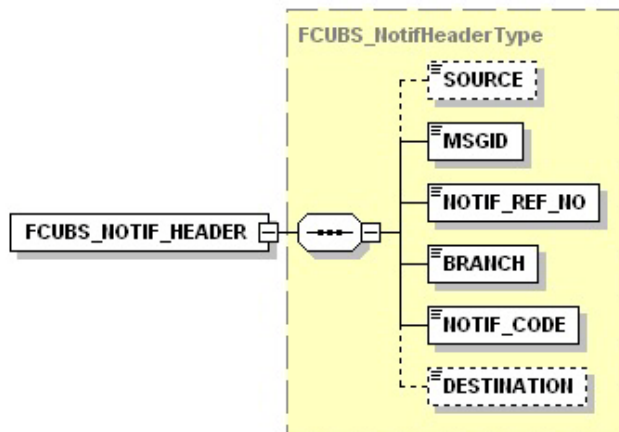
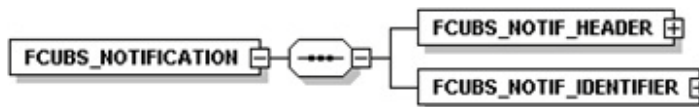

### 4.3.1 FCUBS NOTIFICATION HEADER

The tags under FCUBS NOTIFICATION HEADER have been described below:

#### **SOURCE**

This indicates the name of the External system or the source of the message.

#### **MSGID**

This is the unique reference number generated by Oracle FLEXCUBE.

#### **NOTIF\_REF\_NO.**

This unique reference number identifies each notification message generated in Oracle FLEXCUBE.

**BRANCH**

This indicates the branch in which notification has been triggered.

**NOTIF\_CODE**

This indicates the code for the notification that has been triggered.

**DESTINATION**

For incoming messages, the DESTINATION should be Oracle FLEXCUBE. For response messages, system will populate the SOURCE of the request message as DESTINATION.

*Refer 'Service-Documentation' available under 'Gateway' for details about each message.*

---

# 5. FLEXML Adapter Message Conversion

## 5.1 Introduction

FLEXML Adapter is a component which facilitates the communication between existing FLEXML enabled systems and newer version of Oracle FLEXCUBE based on Gateways. The messages are converted from FLEXML format to Gateway format and vice versa.

The diagram given below indicates that the adapter acts as a middle layer facilitating the exchange of messages between FLEXML based systems and the Oracle FLEXCUBE database.

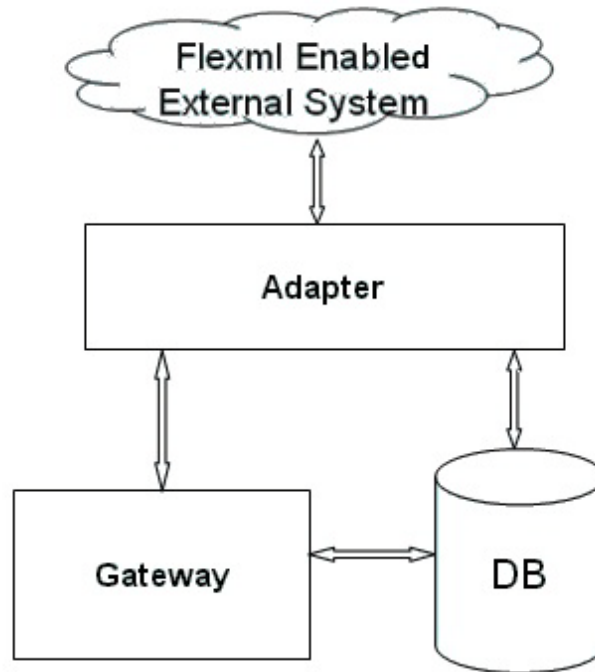

The different channels used by the adapter to communicate with the gateway can be categorized as follows:

- Inbound FLEXML Adapter
- Outbound FLEXML Adapter

## 5.2 Inbound FLEXML Adapter

Inbound FLEXML Adapter provides an XML based interface for the FLEXML enabled external system, to communicate with Oracle FLEXCUBE database. It converts the messages from FLEXML format to gateway format and invokes GW EJB, which handles further processing of the message.

The following communication mechanisms are available to process the incoming FLEXML messages:

- EJB Inbound Adapter – This is used if the external system is compatible with EJB interface. The external system invokes the adapter using EJB interface API method
- MDB Inbound Adapter - This is used if the external system is JMS compatible. The external system invokes the adapter by sending message to JMS Queue.

## 5.2.1 Processing Incoming FLEXML Request Message

The inbound adapter processes an incoming request message in FLEXML format as follows:

1. Adapter receives the request message in FLEXML format
2. The request message is logged in table, if the value of the property file parameter 'FXG\_MSG\_LOG\_FLG' is 'Y'
3. XML message is validated using FLEXML DTD
4. If the message is invalid, the adapter generates parser error message in FLEXML format and sends it back to external system. If the message is valid, the source name, service name, and operation type is retrieved from the message
5. Based on source name, service name and operation type, request and reply XSLT file name is retrieved from database
6. XSLT is applied to convert the message from FLEXML format to GW format
7. GW EJB component is invoked, which processes the request and replies with a message in gateway format
8. XSLT is applied to convert GW reply message to FLEXML format.
9. The reply message is logged in table, if the value of the property file parameter 'FXG\_MSG\_LOG\_FLG' is 'Y'
10. Reply message in FLEXML format is send back to the external system

## 5.3 Outbound FLEXML Adapter

An outbound adapter notifies any internal events within Oracle FLEXCUBE to the external system. For eg, internal events associated with static maintenances or transactions that happen in Oracle FLEXCUBE need to be communicated to the external system.

FLEXML uses the handoff mechanism to transfer data to the external system, whereas Gateway uses notification process for the same. Handoff messages contain complete transaction information, but notification message contains only the primary key of the transaction.

### 5.3.1 Processing Outbound Messages

The outbound messages to the external system are processed as follows:

1. Outbound adapter receives request notification XML message from the notification queue
2. Notification code is retrieved from the notification message
3. Using XSLT maintenance table and notification code, query XSLT, handoff XSLT and all the externals system names related to the notification code are retrieved by the adapter
4. Query XSLT is applied to convert GW notification XML message to GW query message and handoff XSLT is applied to convert GW reply to FLEXML format handoff message
5. The handoff queue name is retrieved using external system maintenance
6. The handoff message is logged in table, if the value of the property file parameter 'FXG\_MSG\_LOG\_FLG' is 'Y'
7. Handoff XML message is send to each external system

### **5.3.2 Mapping FLEXML Format Messages to Gateway Format**

FLEXML uses DTDs to define the structure of an XML document, whereas Gateways use XSDs for the same. Extensible Style Sheet Language (XSL), an XML based transformation language, is used to convert XML documents from one format to another.

The mapping can be done using any of the following methods:

- Optional Attribute Map Approach – X-Path language is used to map between the two XML formats
- Mandatory Attribute Map Approach – the mandatory attributes in the target XML document are mapped in this case.

---

## 6. Annexure – List of Messages

### 6.1 Introduction

This chapter lists out the various messages that fold under the purview of the following Gateway services:

- Inbound application integration – used when any external system needs to add, modify or query information within Oracle FLEXCUBE
- Outbound application integration – used when any external system needs to be notified of the various events that occur within Oracle FLEXCUBE.

### 6.2 Inbound Application Integration – Services

Oracle FLEXCUBE UBS Inbound Application Gateway provides XML based 'Services'. These services consist of one or more 'Operations'. These operations can be invoked by any external system to perform the relevant operation in Oracle FLEXCUBE UBS. The services supported by the Gateway are listed below:

- FCUBSFTService
- FCUBSAccService
- FCUBSDDService
- FCUBSLDService
- FCUBSCustomerService
- FCUBSTDService
- FCUBSPCService
- FCUBSExtPCService
- FCUBSIFService
- FCUBSInteractionService
- FCUBSSIService

#### 6.2.1 FCUBSFTService

All funds transfer operations are logically grouped under a service called 'FCUBSFTService'.

Oracle FLEXCUBE supports the following operations under this service:

- CreateMt101
- AuthorizeMt101
- DeleteMt101
- ModifyMt101
- QueryMt101
- CreateFTContract
- AmendFTContract
- QueryFTContract
- SummaryQueryProduct

### 6.2.1.1 CreateMt101

This is the operation code for creating Mt101 message in Oracle FLEXCUBE. It involves the following messages:

- CreateMt101-Req-Full- This is the request message to create Mt101 message in Oracle FLEXCUBE UBS. An external system which intends to create Mt101 message has to send the request in the format specified. The format of the message is called 'Full-screen', which includes all the fields (input fields and the display fields) as in the corresponding Oracle FLEXCUBE front-end screen.
- CreateMt101-Req-IO- This is the request message to create Mt101 message in Oracle FLEXCUBE UBS. An external system which intends to create Mt101 message has to send the request in the specified format. The format of the message is called 'Input-only', which has only those fields that are actually required for creating MT101 message.
- CreateMt101-Res-Full- This is the response message which is sent back to the external system when an Mt101 message is successfully created in Oracle FLEXCUBE UBS. The format of the message is called 'Full-screen response', which includes all the fields (input fields and the display fields) as in the corresponding Oracle FLEXCUBE screen.
- CreateMt101-Res-PK- This is the response message which is sent back to the external system when an Mt101 message is successfully created in Oracle FLEXCUBE UBS. The format of the message is called 'Primary-Key response', which includes only the primary key fields of the MT101 message in the Oracle FLEXCUBE data store.

### 6.2.1.2 AuthorizeMt101

This is the operation code for authorizing MT101 message in Oracle FLEXCUBE. It involves the following messages:

- AuthorizeMt101-Req-Full- This is the request message to authorize Mt101 message in Oracle FLEXCUBE UBS. An external system which intends to authorize has to send the request in the format specified. The format of the message is called 'Full-screen', which includes all the fields (input fields and the display fields) as in the corresponding Oracle FLEXCUBE front-end screen.
- AuthorizeMt101-Req-IO- This is the request message to authorize Mt101 message in Oracle FLEXCUBE UBS. An external system which intends to authorize MT101 message has to send the request in the specified format. The format of the message is called 'Input-only', which has only those fields that can be used to query.
- AuthorizeMt101-Res-Full- This is the response message which is sent back to the external system when Mt101 message is successfully authorized in Oracle FLEXCUBE UBS. The format of the message is called 'Full-screen response', which includes all the fields (input fields and the display fields) as in the corresponding Oracle FLEXCUBE screen.
- AuthorizeMt101-Res-PK- This is the response message which is sent back to the external system when Mt101 message is successfully authorized in Oracle FLEXCUBE UBS. The format of the message is called 'Primary-Key response', which includes only the primary key fields of the MT101 message in the Oracle FLEXCUBE data store.

### 6.2.1.3 DeleteMt101

This is the operation code for deleting Mt101 message in Oracle FLEXCUBE. It involves the following messages:

- DeleteMt101-Req-Full- This is the request message to delete Mt101 message in Oracle FLEXCUBE UBS. An external system which intends to delete MT101 message has to send the request in the format specified. The format of the message is called 'Full-screen', which includes all the fields (input fields and the display fields) as in the corresponding Oracle FLEXCUBE front-end screen.

- DeleteMt101-Req-IO- This is the request message to delete Mt101 message in Oracle FLEXCUBE UBS. An external system which intends to delete an MT101 message has to send the request in the specified format. The format of the message is called 'Input-only', which has only those fields that are actually required for closing MT101 message.
- DeleteMt101-Res-Full- This is the response message which is sent back to the external system when Mt101 message is successfully deleted in Oracle FLEXCUBE UBS. The format of the message is called 'Full-screen response', which includes all the fields (input fields and the display fields) as in the corresponding Oracle FLEXCUBE screen.
- DeleteMt101-Res-PK- This is the response message which is sent back to the external system when Mt101 message is successfully deleted in Oracle FLEXCUBE UBS. The format of the message is called 'Primary-Key response', which includes only the primary key fields of the MT101 message in the Oracle FLEXCUBE data store.

#### 6.2.1.4 **ModifyMt101**

This is the operation code for modifying Mt101 message in Oracle FLEXCUBE. It involves the following messages:

- ModifyMt101-Req-Full- This is the request message to modify Mt101 message in Oracle FLEXCUBE UBS. An external system which intends to close an MT101 message has to send the request in the format specified. The format of the message is called 'Full-screen', which includes all the fields (input fields and the display fields) as in the corresponding Oracle FLEXCUBE front-end screen.
- ModifyMt101-Req-IO- This is the request message to modify Mt101 message in Oracle FLEXCUBE UBS. An external system which intends to modify an MT101 message has to send the request in the specified format. The format of the message is called 'Input-only', which has only those fields that are actually required for modifying MT101 message.
- ModifyMt101-Res-Full- This is the response message which is sent back to the external system when Mt101 message is successfully modified in Oracle FLEXCUBE UBS. The format of the message is called 'Full-screen response', which includes all the fields (input fields and the display fields) as in the corresponding Oracle FLEXCUBE screen.
- ModifyMt101-Res-PK- This is the response message which is sent back to the external system when Mt101 message is successfully modified in Oracle FLEXCUBE UBS. The format of the message is called 'Primary-Key response', which includes only the primary key fields of the MT101 message in the Oracle FLEXCUBE data store.

---

#### **Note**

Oracle FLEXCUBE allows modification only before the first authorization.

---

#### 6.2.1.5 **QueryMt101**

This is the operation code for querying Mt101 message in Oracle FLEXCUBE. It involves the following messages:

- QueryMt101-Req-Full- This is the request message to query Mt101 message in Oracle FLEXCUBE UBS. An external system which intends to query an MT101 message has to send the request in the format specified. The format of the message is called 'Full-screen', which includes all the fields (input fields and the display fields) as in the corresponding Oracle FLEXCUBE front-end screen.
- QueryMt101-Req-IO- This is the request message to query Mt101 message in Oracle FLEXCUBE UBS. An external system which intends to query an MT101 message has to send the request in the specified format. The format of the message is called 'Input-only', which has only those fields that are actually required for querying an MT101 message.



- QueryMt101-Res-Full- This is the response message which is sent back to the external system when Mt101 message is successfully queried in Oracle FLEXCUBE UBS. The format of the message is called 'Full-screen response', which includes all the fields (input fields and the display fields) as in the corresponding Oracle FLEXCUBE screen.
- QueryMt101-Res-PK- This is the response message which is sent back to the external system when Mt101 message is successfully queried in Oracle FLEXCUBE UBS. The format of the message is called 'Primary-Key response', which includes only the primary key fields of the MT101 message in the Oracle FLEXCUBE data store.

#### **6.2.1.6 CreateFTContract**

This is the operation code for creating FT contract in Oracle FLEXCUBE. It involves the following messages:

- CreateFTContract-Req-Full- This is the request message to create FT contract in Oracle FLEXCUBE UBS. An external system which intends to create FT contract has to send the request in the format specified. The format of the message is called 'Full-screen', which includes all the fields (input fields and the display fields) as in the corresponding Oracle FLEXCUBE front-end screen.
- CreateFTContract-Req-IO- This is the request message to create FT contract in Oracle FLEXCUBE UBS. An external system which intends to create FT contract has to send the request in the specified format. The format of the message is called 'Input-only', which has only those fields that are actually required for creating an FT contract.
- CreateFTContract-Res-Full- This is the response message which is sent back to the external system when FT contract is successfully created in Oracle FLEXCUBE UBS. The format of the message is called 'Full-screen response', which includes all the fields (input fields and the display fields) as in the corresponding Oracle FLEXCUBE screen.
- CreateFTContract-Res-PK- This is the response message which is sent back to the external system when an FT contract is successfully created in Oracle FLEXCUBE UBS. The format of the message is called 'Primary-Key response', which includes only the primary key fields of the FT contract in the Oracle FLEXCUBE data store.

#### **6.2.1.7 AmendFTContract**

This is the operation code for amending FT contract in Oracle FLEXCUBE. It involves the following messages:

- AmendFTContract-Req-Full- This is the request message to amend FT contract in Oracle FLEXCUBE UBS. An external system which intends to amend FT contract has to send the request in the format specified. The format of the message is called 'Full-screen', which includes all the fields (input fields and the display fields) as in the corresponding Oracle FLEXCUBE front-end screen.
- AmendFTContract-Req-IO- This is the request message to amend FT contract in Oracle FLEXCUBE UBS. An external system which intends to amend FT contract has to send the request in the specified format. The format of the message is called 'Input-only', which has only those fields that are actually required for amending an FT contract.
- AmendFTContract-Res-Full- This is the response message which is sent back to the external system when FT contract is successfully amended in Oracle FLEXCUBE UBS. The format of the message is called 'Full-screen response', which includes all the fields (input fields and the display fields) as in the corresponding Oracle FLEXCUBE screen.
- AmendFTContract-Res-PK- This is the response message which is sent back to the external system when an existing FT contract is successfully amended in Oracle FLEXCUBE UBS. The format of the message is called 'Primary-Key response', which includes only the primary key fields of the FT contract in the Oracle FLEXCUBE data store.

### 6.2.1.8 QueryFTContract

This is the operation code for querying FT contract in Oracle FLEXCUBE. It involves the following messages:

- QueryFTcontract-Req-Full- This is the request message to query FT contract in Oracle FLEXCUBE UBS. An external system which intends to query FT contract has to send the request in the format specified. The format of the message is called 'Full-screen', which includes all the fields (input fields and the display fields) as in the corresponding Oracle FLEXCUBE front-end screen.
- QueryFTContract-Req-IO- This is the request message to query FT contract in Oracle FLEXCUBE UBS. An external system which intends to query FT contract has to send the request in the specified format. The format of the message is called 'Input-only', which has only those fields that are actually required for querying an FT contract.
- QueryFTContract-Res-Full- This is the response message which is sent back to the external system when FT contract is successfully queried in Oracle FLEXCUBE UBS. The format of the message is called 'Full-screen response', which includes all the fields (input fields and the display fields) as in the corresponding Oracle FLEXCUBE screen.
- QueryFTContract-Res-PK- This is the response message which is sent back to the external system when FT contract is successfully queried in Oracle FLEXCUBE UBS. The format of the message is called 'Primary-Key response', which includes only the primary key fields of the FT contract in the Oracle FLEXCUBE data store.

### 6.2.1.9 SummaryQueryProduct

This is the operation code for querying FT summary product in Oracle FLEXCUBE.

---

#### **Note**

For this operation, you need to maintain 'FTVPRMNT' as the function for 'SummaryQueryProduct' operation code in 'External System Functions' (GWDEXFUN) screen.

---

### 6.2.2 FCUBSAccService

All account operations are logically grouped under a service called 'FCUBSAccService'.

Oracle FLEXCUBE supports the following operations under this service:

- CheckBookNew
- CheckBookModify
- CheckBookQuery
- CreateTDSim
- QueryGenAdvice
- Create TD CustAcc
- Modify TD CustAcc
- Authorize TD CustAcc
- Delete TD Cust Acc
- Query TDCustAcc
- CreateTDTopUp
- AuthorizeTDTopUp
- DeleteTDTopUp
- ModifyTDTopUp

- CreateVirAcc
- AuthVirAcc
- DeleteVirAcc
- ModifyVirAcc
- CloseVirAcc
- ReopenVirAcc
- QueryVirAcc
- QueryCustAcc

### **6.2.2.1 CheckBookNew**

This is the operation code for creating new Cheque Book in Oracle FLEXCUBE. It involves the following messages:

- CheckBookNew-Req-Full- This is the request message to create new cheque book in Oracle FLEXCUBE UBS. An external system which intends to create a new cheque book has to send the request in the format specified. The format of the message is called 'Full-screen', which includes all the fields (input fields and the display fields) as in the corresponding Oracle FLEXCUBE front-end screen.
- CheckBookNew -Req-IO- This is the request message to create new cheque book in Oracle FLEXCUBE UBS. An external system which intends to create the cheque book has to send the request in the specified format. The format of the message is called 'Input-only', which has only those fields that are actually required for creating a new cheque book.
- CheckBookNew -Res-Full- This is the response message which is sent back to the external system when a new cheque book is successfully created in Oracle FLEXCUBE UBS. The format of the message is called 'Full-screen response', which includes all the fields (input fields and the display fields) as in the corresponding Oracle FLEXCUBE screen.
- CheckBookNew -Res-PK- This is the response message which is sent back to the external system when anew cheque book is successfully created in Oracle FLEXCUBE UBS. The format of the message is called 'Primary-Key response', which includes only the primary key fields of the cheque book record in the Oracle FLEXCUBE data store.

### **6.2.2.2 CheckBookModify**

This is the operation code for modifying new Cheque Book in Oracle FLEXCUBE. It involves the following messages:

- CheckBookModify-Req-Full- This is the request message to modify a cheque book in Oracle FLEXCUBE UBS. An external system which intends to modify a cheque book has to send the request in the format specified. The format of the message is called 'Full-screen', which includes all the fields (input fields and the display fields) as in the corresponding Oracle FLEXCUBE front-end screen.
- CheckBookModify-Req-IO- This is the request message to modify a cheque book in Oracle FLEXCUBE UBS. An external system which intends to modify a cheque book has to send the request in the specified format. The format of the message is called 'Input-only', which has only those fields that are actually required for modifying a cheque book.
- CheckBookModify -Res-Full- This is the response message which is sent back to the external system when a cheque book is successfully modified in Oracle FLEXCUBE UBS. The format of the message is called 'Full-screen response', which includes all the fields (input fields and the display fields) as in the corresponding Oracle FLEXCUBE screen.

- CheckBookModify -Res-PK- This is the response message which is sent back to the external system when a cheque book is successfully modified in Oracle FLEXCUBE UBS. The format of the message is called 'Primary-Key response', which includes only the primary key fields of the cheque book in the Oracle FLEXCUBE data store.

### **6.2.2.3 CheckBookQuery**

This is the operation code for querying new Cheque Book in Oracle FLEXCUBE. It involves the following messages:

- CheckBookQuery-Req-Full- This is the request message to query a cheque book in Oracle FLEXCUBE UBS. An external system which intends to query a cheque book has to send the request in the format specified. The format of the message is called 'Full-screen', which includes all the fields (input fields and the display fields) as in the corresponding Oracle FLEXCUBE front-end screen.
- CheckBookQuery-Req-IO- This is the request message to query a cheque book in Oracle FLEXCUBE UBS. An external system which intends to query a cheque book has to send the request in the specified format. The format of the message is called 'Input-only', which has only those fields that are actually required for querying a cheque book.
- CheckBookQuery -Res-Full- This is the response message which is sent back to the external system when a cheque book is successfully queried in Oracle FLEXCUBE UBS. The format of the message is called 'Full-screen response', which includes all the fields (input fields and the display fields) as in the corresponding Oracle FLEXCUBE screen.
- CheckBookQuery -Res-PK- This is the response message which is sent back to the external system when a cheque book is successfully queried in Oracle FLEXCUBE UBS. The format of the message is called 'Primary-Key response', which includes only the primary key fields of the cheque book in the Oracle FLEXCUBE data store.

### **6.2.2.4 CreateTDSim**

This is the operation code for creating TD simulation in Oracle FLEXCUBE. It involves the following messages:

- CreateTDSim-Req-Full- This is the request message to create TD simulation in Oracle FLEXCUBE UBS. An external system which intends to TD simulation has to send the request in the format specified. The format of the message is called 'Full-screen', which includes all the fields (input fields and the display fields) as in the corresponding Oracle FLEXCUBE front-end screen.
- CreateTDSim -Req-IO- This is the request message to create TD simulation in Oracle FLEXCUBE UBS. An external system which intends to TD simulation has to send the request in the specified format. The format of the message is called 'Input-only', which has only those fields that are actually required for creating TD simulation.
- CreateTDSim -Res-Full- This is the response message which is sent back to the external system when a TD simulation is successfully created in Oracle FLEXCUBE UBS. The format of the message is called 'Full-screen response', which includes all the fields (input fields and the display fields) as in the corresponding Oracle FLEXCUBE screen.
- CreateTDSim -Res-PK- This is the response message which is sent back to the external system when a TD simulation is successfully created in Oracle FLEXCUBE UBS. The format of the message is called 'Primary-Key response', which includes only the primary key fields of the TD simulation in the Oracle FLEXCUBE data store.

### **6.2.2.5 QueryGenAdvice**

This is the operation code for querying GenAdvice in Oracle FLEXCUBE. It involves the following messages:

- QueryGenAdvice -Req-IO- This is the request message to query GenAdvice in Oracle FLEXCUBE UBS. An external system which intends to query GenAdvice has to send the request in the specified format. The format of the message is called 'Input-only', which has only those fields that are actually required for querying GenAdvice.
- QueryGenAdvice -Res-Full- This is the response message which is sent back to the external system when GenAdvice is successfully queried in Oracle FLEXCUBE UBS. The format of the message is called 'Full-screen response', which includes all the fields (input fields and the display fields) as in the corresponding Oracle FLEXCUBE screen.

#### **6.2.2.6 Create TDCustAcc**

This is the operation code for creating TD in Oracle FLEXCUBE. It involves the following messages:

- CreateTDCustAcc-Req-Full- This is the request message to create TD in Oracle FLEXCUBE UBS. An external system which intends to create TD has to send the request in the format specified. The format of the message is called 'Full-screen', which includes all the fields (input fields and the display fields) as in the corresponding Oracle FLEXCUBE front-end screen.
- CreateTDCustAcc -Req-IO- This is the request message to create TD in Oracle FLEXCUBE UBS. An external system which intends to createTD has to send the request in the specified format. The format of the message is called 'Input-only', which has only those fields that are actually required for creating a TD.
- CreateTDCustAcc -Res-Full- This is the response message which is sent back to the external system when a TD is successfully created in Oracle FLEXCUBE UBS. The format of the message is called 'Full-screen response', which includes all the fields (input fields and the display fields) as in the corresponding Oracle FLEXCUBE screen.
- CreateTDCustAcc -Res-PK- This is the response message which is sent back to the external system when a TD is successfully created in Oracle FLEXCUBE UBS. The format of the message is called 'Primary-Key response', which includes only the primary key fields of the TD creation in the Oracle FLEXCUBE data store.

#### **6.2.2.7 AuthorizeTDCustAcc**

This is the operation code for authorizing the TD in Oracle FLEXCUBE. It involves the following messages:

- AuthorizeTDCustAcc-Req-Full- This is the request message to authorize TD in Oracle FLEXCUBE UBS. An external system which intends to authorize a TD has to send the request in the format specified. The format of the message is called 'Full-screen', which includes all the fields (input fields and the display fields) as in the corresponding Oracle FLEXCUBE front-end screen.
- AuthorizeTDCustAcc -Req-IO- This is the request message to authorize TD in Oracle FLEXCUBE UBS. An external system which intends to authorize a TD has to send the request in the specified format. The format of the message is called 'Input-only', which has only those fields that are actually required for creating TD simulation.
- AuthorizeTDCustAcc -Res-Full- This is the response message which is sent back to the external system when a TD is successfully authorized in Oracle FLEXCUBE UBS. The format of the message is called 'Full-screen response', which includes all the fields (input fields and the display fields) as in the corresponding Oracle FLEXCUBE screen.
- AuthorizeTDCustAcc -Res-PK- This is the response message which is sent back to the external system when a TD is successfully authorized in Oracle FLEXCUBE UBS. The format of the message is called 'Primary-Key response', which includes only the primary key fields of the TD authorization in the Oracle FLEXCUBE data store.

### 6.2.2.8 DeleteTDCustAcc

This is the operation code for deleting a TD in Oracle FLEXCUBE. It involves the following messages:

- DeleteTDCustAcc-Req-Full- This is the request message to delete TD in Oracle FLEXCUBE UBS. An external system which intends to delete a TD has to send the request in the format specified. The format of the message is called 'Full-screen', which includes all the fields (input fields and the display fields) as in the corresponding Oracle FLEXCUBE front-end screen.
- DeleteTDCustAcc -Req-IO- This is the request message to delete TD in Oracle FLEXCUBE UBS. An external system which intends to delete a TD has to send the request in the specified format. The format of the message is called 'Input-only', which has only those fields that are actually required for creating TD simulation.
- DeleteTDCustAcc -Res-Full- This is the response message which is sent back to the external system when a TD is successfully deleted in Oracle FLEXCUBE UBS. The format of the message is called 'Full-screen response', which includes all the fields (input fields and the display fields) as in the corresponding Oracle FLEXCUBE screen.
- DeleteTDCustAcc -Res-PK- This is the response message which is sent back to the external system when a TD is successfully deleted in Oracle FLEXCUBE UBS. The format of the message is called 'Primary-Key response', which includes only the primary key fields of the TD deletion in the Oracle FLEXCUBE data store.

### 6.2.2.9 Query TDCustAcc

This is the operation code for querying TD account in Oracle FLEXCUBE. It involves the following messages:

- QueryTDCustAcc -Req-IO- This is the request message to query a TD account in Oracle FLEXCUBE UBS. An external system which intends to query TD account has to send the request in the specified format. The format of the message is called 'Input-only', which has only those fields that are actually required for querying a TD account
- QueryTDCustAcc -Res-Full- This is the response message which is sent back to the external system when TD account is successfully queried in Oracle FLEXCUBE UBS. The format of the message is called 'Full-screen response', which includes all the fields (input fields and the display fields) as in the corresponding Oracle FLEXCUBE screen.

### 6.2.2.10 CreateTDTopUp

This is the operation code for doing a top-up of TD in Oracle FLEXCUBE. It involves the following messages:

- CreateTDTopUp-Req-Full- This is the request message to top-up TD account in Oracle FLEXCUBE UBS. An external system which intends to top-up a TD account has to send the request in the format specified. The format of the message is called 'Full-screen', which includes all the fields (input fields and the display fields) as in the corresponding Oracle FLEXCUBE front-end screen.
- CreateTDTopUp -Req-IO- This is the request message to top-up TD account in Oracle FLEXCUBE UBS. An external system which intends to top-up TD account has to send the request in the specified format. The format of the message is called 'Input-only', which has only those fields that are actually required for topping up a TD.
- CreateTDTopUp -Res-Full- This is the response message which is sent back to the external system when a TD account is successfully topped-up in Oracle FLEXCUBE UBS. The format of the message is called 'Full-screen response', which includes all the fields (input fields and the display fields) as in the corresponding Oracle FLEXCUBE screen.



- CreateTDTopUp-Res-PK- This is the response message which is sent back to the external system when a TD account is successfully topped-up in Oracle FLEXCUBE UBS. The format of the message is called 'Primary-Key response', which includes only the primary key fields of the top-up in the Oracle FLEXCUBE data store.

### 6.2.2.11 AuthorizeTDTopUp

This is the operation code for authorizing top-up request of TD in Oracle FLEXCUBE. It involves the following messages:

- AuthorizeTDTopUp-Req-Full- This is the request message to authorize the top-up of TD account in Oracle FLEXCUBE UBS. An external system which intends to authorize the top-up has to send the request in the format specified. The format of the message is called 'Full-screen', which includes all the fields (input fields and the display fields) as in the corresponding Oracle FLEXCUBE front-end screen.
- AuthorizeTDTopUp -Req-IO- This is the request message to authorize the top-up of TD account in Oracle FLEXCUBE UBS. An external system which intends to authorize the top-up of TD account has to send the request in the specified format. The format of the message is called 'Input-only', which has only those fields that are actually required for topping up a TD.
- AuthorizeTDTopUp -Res-Full- This is the response message which is sent back to the external system when a TD account is topped-up is successfully authorized in Oracle FLEXCUBE UBS. The format of the message is called 'Full-screen response', which includes all the fields (input fields and the display fields) as in the corresponding Oracle FLEXCUBE screen.
- AuthorizeTDTopUp -Res-PK- This is the response message which is sent back to the external system when a TD account top-up, is authorized in Oracle FLEXCUBE UBS. The format of the message is called 'Primary-Key response', which includes only the primary key fields of the top-up in the Oracle FLEXCUBE data store.

### 6.2.2.12 DeleteTDTopUp

This is the operation code for deleting top-up request of TD in Oracle FLEXCUBE. It involves the following messages:

- DeleteTDTopUp-Req-Full- This is the request message to delete the top-up of TD account in Oracle FLEXCUBE UBS. An external system which intends to delete the top-up request created has to send the request in the format specified. The format of the message is called 'Full-screen', which includes all the fields (input fields and the display fields) as in the corresponding Oracle FLEXCUBE front-end screen.
- DeleteTDTopUp -Req-IO- This is the request message to delete the top-up of TD account in Oracle FLEXCUBE UBS. An external system which intends to delete the top-up of TD account has to send the request in the specified format. The format of the message is called 'Input-only', which has only those fields that are actually required for top-up of a TD.
- DeleteTDTopUp -Res-Full- This is the response message which is sent back to the external system when a top-up request is successfully deleted in Oracle FLEXCUBE UBS. The format of the message is called 'Full-screen response', which includes all the fields (input fields and the display fields) as in the corresponding Oracle FLEXCUBE screen.
- DeleteTDTopUp -Res-PK- This is the response message which is sent back to the external system when a top-up request is deleted from Oracle FLEXCUBE UBS. The format of the message is called 'Primary-Key response', which includes only the primary key fields of the top-up in the Oracle FLEXCUBE data store.

### 6.2.2.13 ModifyTDTopUp

This is the operation code for modifying account structure in Oracle FLEXCUBE. It involves the following messages:

- **ModifyTDTopUp-Req-Full-** This is the request message to modify a TD top-up in Oracle FLEXCUBE UBS. An external system which intends to modify a TD top-up has to send the request in the format specified. The format of the message is called 'Full-screen', which includes all the fields (input fields and the display fields) as in the corresponding Oracle FLEXCUBE front-end screen.
- **ModifyTDTopUp-Req-IO-** This is the request message to modify a TD top-up in Oracle FLEXCUBE UBS. An external system which intends to modify a TD top-up has to send the request in the specified format. The format of the message is called 'Input-only', which has only those fields that are actually required for modifying a TD top-up.
- **ModifyTDTopUp -Res-Full-** This is the response message which is sent back to the external system when modifying a TD top-up is successfully modified in Oracle FLEXCUBE UBS. The format of the message is called 'Full-screen response', which includes all the fields (input fields and the display fields) as in the corresponding Oracle FLEXCUBE screen.
- **ModifyTDTopUP -Res-PK-** This is the response message which is sent back to the external system when modifying a TD top-up is successfully modified in Oracle FLEXCUBE UBS. The format of the message is called 'Primary-Key response', which includes only the primary key fields of the modifying a TD top-up in the Oracle FLEXCUBE data store.

### 6.2.2.14 CreateVirAcc

This is the operation code for creating a virtual account in Oracle FLEXCUBE. It involves the following messages:

- **CreateVirAcc-Req-Full-** This is the request message to create a virtual account in Oracle FLEXCUBE UBS. An external system which intends to create a virtual account has to send the request in the format specified. The format of the message is called 'Full-screen', which includes all the fields (input fields and the display fields) as in the corresponding Oracle FLEXCUBE front-end screen.
- **CreateVirAcc -Req-IO-** This is the request message to create a virtual account in Oracle FLEXCUBE UBS. An external system which intends to create a virtual account has to send the request in the specified format. The format of the message is called 'Input-only', which has only those fields that are actually required for opening a virtual account.
- **CreateVirAcc -Res-Full-** This is the response message which is sent back to the external system when a virtual account is successfully created in Oracle FLEXCUBE UBS. The format of the message is called 'Full-screen response', which includes all the fields (input fields and the display fields) as in the corresponding Oracle FLEXCUBE screen.
- **CreateVirAcc-Res-PK-** This is the response message which is sent back to the external system when a virtual account is successfully created in Oracle FLEXCUBE UBS. The format of the message is called 'Primary-Key response', which includes only the primary key fields of the virtual account opening in the Oracle FLEXCUBE data store.

### 6.2.2.15 AuthVirAcc

This is the operation code for authorizing the virtual account in Oracle FLEXCUBE. It involves the following messages:

- **AuthorizeVirAcc-Req-Full-** This is the request message to authorize virtual accounts in Oracle FLEXCUBE UBS. An external system which intends to authorize a virtual account has to send the request in the format specified. The format of the message is



called 'Full-screen', which includes all the fields (input fields and the display fields) as in the corresponding Oracle FLEXCUBE front-end screen.

- AuthorizeVirAcc -Req-IO- This is the request message to authorize a virtual account in Oracle FLEXCUBE UBS. An external system which intends to authorize a virtual account has to send the request in the specified format. The format of the message is called 'Input-only', which has only those fields that are actually required for creating virtual account simulation.
- AuthorizeVirAcc -Res-Full- This is the response message which is sent back to the external system when a virtual account is successfully authorized in Oracle FLEXCUBE UBS. The format of the message is called 'Full-screen response', which includes all the fields (input fields and the display fields) as in the corresponding Oracle FLEXCUBE screen.
- AuthorizeVirAcc -Res-PK- This is the response message which is sent back to the external system when a virtual account is successfully authorized in Oracle FLEXCUBE UBS. The format of the message is called 'Primary-Key response', which includes only the primary key fields of the virtual account authorization in the Oracle FLEXCUBE data store.

### **6.2.2.16 DeleteVirAcc**

This is the operation code for deleting a virtual account in Oracle FLEXCUBE. It involves the following messages:

- DeleteVirAcc-Req-Full- This is the request message to delete a virtual account in Oracle FLEXCUBE UBS. An external system which intends to delete a virtual account has to send the request in the format specified. The format of the message is called 'Full-screen', which includes all the fields (input fields and the display fields) as in the corresponding Oracle FLEXCUBE front-end screen.
- DeleteVirAcc -Req-IO- This is the request message to delete a virtual account in Oracle FLEXCUBE UBS. An external system which intends to delete a virtual account has to send the request in the specified format. The format of the message is called 'Input-only', which has only those fields that are actually required for creating a virtual account.
- DeleteVirAcc -Res-Full- This is the response message which is sent back to the external system when a virtual account is successfully deleted in Oracle FLEXCUBE UBS. The format of the message is called 'Full-screen response', which includes all the fields (input fields and the display fields) as in the corresponding Oracle FLEXCUBE screen.
- DeleteVirAcc -Res-PK- This is the response message which is sent back to the external system when a virtual account is successfully deleted in Oracle FLEXCUBE UBS. The format of the message is called 'Primary-Key response', which includes only the primary key fields of the virtual account deletion in the Oracle FLEXCUBE data store.

### **6.2.2.17 ModifyVirAcc**

This is the operation code for modifying a virtual account in Oracle FLEXCUBE. It involves the following messages:

- ModifyVirAcc-Req-Full- This is the request message to modify a virtual account in Oracle FLEXCUBE UBS. An external system which intends to modify a virtual account has to send the request in the format specified. The format of the message is called 'Full-screen', which includes all the fields (input fields and the display fields) as in the corresponding Oracle FLEXCUBE front-end screen.
- ModifyVirAcc-Req-IO- This is the request message to modify a virtual account in Oracle FLEXCUBE UBS. An external system which intends to modify a virtual account has to send the request in the specified format. The format of the message is called 'Input-only', which has only those fields that are actually required for modifying a virtual account.

- **ModifyVirAcc -Res-Full-** This is the response message which is sent back to the external system when a virtual account is successfully modified in Oracle FLEXCUBE UBS. The format of the message is called 'Full-screen response', which includes all the fields (input fields and the display fields) as in the corresponding Oracle FLEXCUBE screen.
- **ModifyVirAcc -Res-PK-** This is the response message which is sent back to the external system when a virtual account is successfully modified in Oracle FLEXCUBE UBS. The format of the message is called 'Primary-Key response', which includes only the primary key fields of the virtual account in the Oracle FLEXCUBE data store.

### **6.2.2.18 CloseVirAcc**

This is the operation code for closing a virtual account in Oracle FLEXCUBE. It involves the following messages:

- **CloseVirAcc-Req-Full-** This is the request message to close a virtual account in Oracle FLEXCUBE UBS. An external system which intends to close a virtual account has to send the request in the format specified. The format of the message is called 'Full-screen', which includes all the fields (input fields and the display fields) as in the corresponding Oracle FLEXCUBE front-end screen.
- **CloseVirAcc-Req-IO-** This is the request message to close a virtual account in Oracle FLEXCUBE UBS. An external system which intends to close a virtual account has to send the request in the specified format. The format of the message is called 'Input-only', which has only those fields that are actually required for closing a virtual account.
- **CloseVirAcc -Res-Full-** This is the response message which is sent back to the external system when a virtual account is successfully closed in Oracle FLEXCUBE UBS. The format of the message is called 'Full-screen response', which includes all the fields (input fields and the display fields) as in the corresponding Oracle FLEXCUBE screen.
- **CloseVirAcc -Res-PK-** This is the response message which is sent back to the external system when a virtual account is successfully closed in Oracle FLEXCUBE UBS. The format of the message is called 'Primary-Key response', which includes only the primary key fields of the virtual account in the Oracle FLEXCUBE data store.

### **6.2.2.19 ReopenVirAcc**

This is the operation code for reopening a virtual account in Oracle FLEXCUBE. It involves the following messages:

- **ReopenVirAcc-Req-Full-** This is the request message to reopen a virtual account in Oracle FLEXCUBE UBS. An external system which intends to reopen a virtual account has to send the request in the format specified. The format of the message is called 'Full-screen', which includes all the fields (input fields and the display fields) as in the corresponding Oracle FLEXCUBE front-end screen.
- **ReopenVirAcc-Req-IO-** This is the request message to reopen a virtual account in Oracle FLEXCUBE UBS. An external system which intends to reopen a virtual account has to send the request in the specified format. The format of the message is called 'Input-only', which has only those fields that are actually required for reopening a virtual account.
- **ReopenVirAcc -Res-Full-** This is the response message which is sent back to the external system when a virtual account is successfully reopened in Oracle FLEXCUBE UBS. The format of the message is called 'Full-screen response', which includes all the fields (input fields and the display fields) as in the corresponding Oracle FLEXCUBE screen.
- **ReopenVirAcc -Res-PK-** This is the response message which is sent back to the external system when a virtual account is successfully reopened in Oracle FLEXCUBE UBS. The format of the message is called 'Primary-Key response', which includes only the primary key fields of the virtual account in the Oracle FLEXCUBE data store.

### **6.2.2.20 QueryVirAcc**

This is the operation code for querying a virtual account in Oracle FLEXCUBE. It involves the following messages:

- QueryVirAcc -Req-IO- This is the request message to query a virtual account in Oracle FLEXCUBE UBS. An external system which intends to query a virtual account has to send the request in the specified format. The format of the message is called 'Input-only', which has only those fields that are actually required for querying virtual account.
- QueryVirAcc -Res-Full- This is the response message which is sent back to the external system when a virtual account is successfully queried in Oracle FLEXCUBE UBS. The format of the message is called 'Full-screen response', which includes all the fields (input fields and the display fields) as in the corresponding Oracle FLEXCUBE screen.

### **6.2.2.21 QueryCustAcc**

This service is used by external channels to retrieve customer account details from the Oracle FLEXCUBE Universal Banking System:

- QueryCustAcc -Req-IO- This is the request message to query a customer account details in Oracle FLEXCUBE UBS. An external system which intends to query a virtual account has to send the request in the specified format. The format of the message is called 'Input-only', which has only those fields that are actually required for querying virtual account.
- QueryCustAcc -Res-Full- This is the response message which is sent back to the external system when a customer account is successfully queried in Oracle FLEXCUBE UBS. The format of the message is called 'Full-screen response', which includes all the fields (input fields and the display fields) as in the corresponding Oracle FLEXCUBE screen.

## **6.2.3 FCUBSDDService**

All the demand draft operations are logically grouped under a service called 'FCUBSDDService'.

Oracle FLEXCUBE supports the following operations under this service:

- CreateTransaction
- QueryDDTransaction

### **6.2.3.1 CreateTransaction**

This is the operation code for creating transaction in Oracle FLEXCUBE. It involves the following messages:

- CreateTransaction-Req-Full- This is the request message to create transaction in Oracle FLEXCUBE UBS. An external system which intends to create transaction has to send the request in the format specified. The format of the message is called 'Full-screen', which includes all the fields (input fields and the display fields) as in the corresponding Oracle FLEXCUBE front-end screen.
- CreateTransaction-Req-IO- This is the request message to create transaction in Oracle FLEXCUBE UBS. An external system which intends to create transaction has to send the request in the specified format. The format of the message is called 'Input-only', which has only those fields that are actually required for creating a transaction.
- CreateTransaction-Res-Full- This is the response message which is sent back to the external system when transaction is successfully created in Oracle FLEXCUBE UBS. The format of the message is called 'Full-screen response', which includes all the fields (input fields and the display fields) as in the corresponding Oracle FLEXCUBE screen.

- CreateTransaction-Res-PK- This is the response message which is sent back to the external system when a transaction is successfully created in Oracle FLEXCUBE UBS. The format of the message is called 'Primary-Key response', which includes only the primary key fields of the transaction record in the Oracle FLEXCUBE data store.

### 6.2.3.2 QueryDDTransaction

This is the operation code for querying DD Transaction in Oracle FLEXCUBE. It involves the following messages:

- QueryDDTransaction-Req-Full- This is the request message to query DD Transaction in Oracle FLEXCUBE UBS. An external system which intends to query a DD transaction has to send the request in the format specified. The format of the message is called 'Full-screen', which includes all the fields (input fields and the display fields) as in the corresponding Oracle FLEXCUBE front-end screen.
- QueryDDTransaction-Req-IO- This is the request message to query DD Transaction in Oracle FLEXCUBE UBS. An external system which intends to query a DD transaction has to send the request in the specified format. The format of the message is called 'Input-only', which has only those fields that are actually required for querying a DD transaction.
- QueryDDTransaction-Res-Full- This is the response message which is sent back to the external system when DD Transaction is successfully queried in Oracle FLEXCUBE UBS. The format of the message is called 'Full-screen response', which includes all the fields (input fields and the display fields) as in the corresponding Oracle FLEXCUBE screen.
- QueryDDTransaction-Res-PK- This is the response message which is sent back to the external system when DD Transaction is successfully queried in Oracle FLEXCUBE UBS. The format of the message is called 'Primary-Key response', which includes only the primary key fields of the DD transaction in the Oracle FLEXCUBE data store.

### 6.2.4 FCUBSLDService

Corporate deposit operations are logically grouped under a service called 'FCUBSLDService'.

Oracle FLEXCUBE supports the following operations under this service:

- LDActivateSimulate
- DeleteLDSIMContract
- QueryLDSIMContract
- LDVamiCreateSim
- LDVamiQuerySim
- QueryLDPaymentSim
- CreateLDPaymentSim

#### 6.2.4.1 LDActivateSimulate

This is the operation code for activating corporate deposits simulation in Oracle FLEXCUBE. It involves the following messages:

- LDActivateSimulate-Req-Full- This is the request message to activate corporate deposits simulation in Oracle FLEXCUBE UBS. An external system which intends to activate corporate deposits simulation has to send the request in the format specified. The format of the message is called 'Full-screen', which includes all the fields (input fields and the display fields) as in the corresponding Oracle FLEXCUBE front-end screen.

- **LDActivateSimulate -Req-IO-** This is the request message to activate corporate deposits simulation in Oracle FLEXCUBE UBS. An external system which intends to activate corporate deposits simulation has to send the request in the specified format. The format of the message is called 'Input-only', which has only those fields that are actually required for activating corporate deposits simulation.
- **LDActivateSimulate -Res-Full-** This is the response message which is sent back to the external system when corporate deposits simulation is successfully activated in Oracle FLEXCUBE UBS. The format of the message is called 'Full-screen response', which includes all the fields (input fields and the display fields) as in the corresponding Oracle FLEXCUBE screen.
- **LDActivateSimulate -Res-PK-** This is the response message which is sent back to the external system when an existing corporate deposits simulation is successfully activated in Oracle FLEXCUBE UBS. The format of the message is called 'Primary-Key response', which includes only the primary key fields of the corporate deposits simulation in the Oracle FLEXCUBE data store.

#### **6.2.4.2 DeleteLDSIMContract**

This is the operation code for deleting LD simulation contract in Oracle FLEXCUBE. It involves the following messages:

- **DeleteLDSIMContract-Req-Full-** This is the request message to delete LD simulation contract in Oracle FLEXCUBE UBS. An external system which intends to delete LD simulation contract has to send the request in the format specified. The format of the message is called 'Full-screen', which includes all the fields (input fields and the display fields) as in the corresponding Oracle FLEXCUBE front-end screen.
- **DeleteLDSIMContract -Req-IO-** This is the request message to delete LD simulation contract in Oracle FLEXCUBE UBS. An external system which intends to delete LD simulation contract has to send the request in the specified format. The format of the message is called 'Input-only', which has only those fields that are actually required for deleting LD simulation contract.
- **DeleteLDSIMContract -Res-Full-** This is the response message which is sent back to the external system when LD simulation contract is successfully deleted in Oracle FLEXCUBE UBS. The format of the message is called 'Full-screen response', which includes all the fields (input fields and the display fields) as in the corresponding Oracle FLEXCUBE screen.
- **DeleteLDSIMContract -Res-PK-** This is the response message which is sent back to the external system when an existing LD simulation contract is successfully deleted in Oracle FLEXCUBE UBS. The format of the message is called 'Primary-Key response', which includes only the primary key fields of the LD simulation contract in the Oracle FLEXCUBE data store.

#### **6.2.4.3 QueryLDSIMContract**

This is the operation code for querying LD simulation contract in Oracle FLEXCUBE. It involves the following messages:

- **DeleteQueryLDSIMContract -Req-IO-** This is the request message to query LD simulation contract in Oracle FLEXCUBE UBS. An external system which intends to query LD simulation contract has to send the request in the specified format. The format of the message is called 'Input-only', which has only those fields that are actually required for querying LD simulation contract.
- **DeleteQueryLDSIMContract -Res-Full-** This is the response message which is sent back to the external system when LD simulation contract is successfully queried in Oracle FLEXCUBE UBS. The format of the message is called 'Full-screen response', which includes all the fields (input fields and the display fields) as in the corresponding Oracle FLEXCUBE screen.

#### **6.2.4.4 LDVamiCreateSim**

This is the operation code for creating LD VAMI Simulation contract in Oracle FLEXCUBE. It involves the following messages:

- LDVamiCreateSim-Req-Full- This is the request message to create LD VAMI simulation contract in Oracle FLEXCUBE UBS. An external system which intends to create LD VAMI simulation contract has to send the request in the format specified. The format of the message is called 'Full-screen', which includes all the fields (input fields and the display fields) as in the corresponding Oracle FLEXCUBE front-end screen.
- LDVamiCreateSim -Req-IO- This is the request message to create LD VAMI simulation contract in Oracle FLEXCUBE UBS. An external system which intends to create LD VAMI simulation contract has to send the request in the specified format. The format of the message is called 'Input-only', which has only those fields that are actually required for creating LD VAMI simulation.
- LDVamiCreateSim -Res-Full- This is the response message which is sent back to the external system when LD VAMI simulation contract is successfully created in Oracle FLEXCUBE UBS. The format of the message is called 'Full-screen response', which includes all the fields (input fields and the display fields) as in the corresponding Oracle FLEXCUBE screen.
- LDVamiCreateSim -Res-PK- This is the response message which is sent back to the external system when an LD VAMI simulation contract is successfully created in Oracle FLEXCUBE UBS. The format of the message is called 'Primary-Key response', which includes only the primary key fields of the LD VAMI simulation in the Oracle FLEXCUBE data store.

#### **6.2.4.5 LDVamiQuerySim**

This is the operation code for querying LD VAMI Simulation contract in Oracle FLEXCUBE. It involves the following messages:

- LDVamiQuerySim -Req-IO- This is the request message to query LD VAMI simulation contract in Oracle FLEXCUBE UBS. An external system which intends to query LD VAMI simulation contract has to send the request in the specified format. The format of the message is called 'Input-only', which has only those fields that are actually required for querying LD VAMI simulation.
- LDVamiQuerySim -Res-Full- This is the response message which is sent back to the external system when LD VAMI simulation contract is successfully queried in Oracle FLEXCUBE UBS. The format of the message is called 'Full-screen response', which includes all the fields (input fields and the display fields) as in the corresponding Oracle FLEXCUBE screen.

#### **6.2.4.6 QueryLDPaymentSim**

This is the operation code for querying LD Payment Simulation in Oracle FLEXCUBE. It involves the following messages:

- QueryLDPaymentSim -Req-IO- This is the request message to query LD payment simulation in Oracle FLEXCUBE UBS. An external system which intends to query LD payment simulation has to send the request in the specified format. The format of the message is called 'Input-only', which has only those fields that are actually required for querying LD payment simulation.
- QueryLDPaymentSim -Res-Full- This is the response message which is sent back to the external system when LD payment simulation is successfully queried in Oracle FLEXCUBE UBS. The format of the message is called 'Full-screen response', which includes all the fields (input fields and the display fields) as in the corresponding Oracle FLEXCUBE screen.



#### 6.2.4.7 CreateLDPaymentSim

This is the operation code for creating LD Payment Simulation in Oracle FLEXCUBE. It involves the following messages:

- CreateLDPaymentSim-Req-Full- This is the request message to create LD payment simulation in Oracle FLEXCUBE UBS. An external system which intends to create LD payment simulation has to send the request in the format specified. The format of the message is called 'Full-screen', which includes all the fields (input fields and the display fields) as in the corresponding Oracle FLEXCUBE front-end screen.
- CreateLDPaymentSim -Req-IO- This is the request message to create LD payment simulation in Oracle FLEXCUBE UBS. An external system which intends to create LD payment simulation has to send the request in the specified format. The format of the message is called 'Input-only', which has only those fields that are actually required for creating LD payment simulation.
- CreateLDPaymentSim -Res-Full- This is the response message which is sent back to the external system when LD payment simulation is successfully created in Oracle FLEXCUBE UBS. The format of the message is called 'Full-screen response', which includes all the fields (input fields and the display fields) as in the corresponding Oracle FLEXCUBE screen.
- CreateLDPaymentSim -Res-PK- This is the response message which is sent back to the external system when an LD payment simulation is successfully created in Oracle FLEXCUBE UBS. The format of the message is called 'Primary-Key response', which includes only the primary key fields of the LD payment simulation in the Oracle FLEXCUBE data store.

#### 6.2.5 FCUBSCustomerService

Customer related operations are logically grouped under a service called 'FCUBSCustomerService'.

Oracle FLEXCUBE supports the following operations under this service:

- AccountStructureNew
- AccountStructureModify
- AccountStructureQuery
- CreateAmtBlk
- ModifyAmtBlk
- CloseAmtBlk
- CreateCustomer.
- ModifyCustomer.
- AuthorizeCustomer.
- QueryCustomer
- CreateClosureData
- AuthorizeClosureData
- ModifyClosureData

##### 6.2.5.1 QueryClosureDataAccountStructureNew

This is the operation code for creating Account Structure in Oracle FLEXCUBE. It involves the following messages:

- AccountStructureNew-Req-Full- This is the request message to create account structure in Oracle FLEXCUBE UBS. An external system which intends to create

account structure has to send the request in the format specified. The format of the message is called 'Full-screen', which includes all the fields (input fields and the display fields) as in the corresponding Oracle FLEXCUBE front-end screen.

- AccountStructureNew-Req-IO- This is the request message to create account structure in Oracle FLEXCUBE UBS. An external system which intends to create account structure has to send the request in the specified format. The format of the message is called 'Input-only', which has only those fields that are actually required for creating account structure.
- AccountStructureNew -Res-Full- This is the response message which is sent back to the external system when account structure is successfully created in Oracle FLEXCUBE UBS. The format of the message is called 'Full-screen response', which includes all the fields (input fields and the display fields) as in the corresponding Oracle FLEXCUBE screen.
- AccountStructureNew -Res-PK- This is the response message which is sent back to the external system when a new account structure is successfully created in Oracle FLEXCUBE UBS. The format of the message is called 'Primary-Key response', which includes only the primary key fields of the account structure in the Oracle FLEXCUBE data store.

### **6.2.5.2 AccountStructureModify**

This is the operation code for modifying account structure in Oracle FLEXCUBE. It involves the following messages:

- AccountStructureModify-Req-Full- This is the request message to modify an account structure in Oracle FLEXCUBE UBS. An external system which intends to modify an account structure has to send the request in the format specified. The format of the message is called 'Full-screen', which includes all the fields (input fields and the display fields) as in the corresponding Oracle FLEXCUBE front-end screen.
- AccountStructureModify-Req-IO- This is the request message to modify an account structure in Oracle FLEXCUBE UBS. An external system which intends to modify an account structure has to send the request in the specified format. The format of the message is called 'Input-only', which has only those fields that are actually required for modifying account structure.
- AccountStructureModify -Res-Full- This is the response message which is sent back to the external system when an account structure is successfully modified in Oracle FLEXCUBE UBS. The format of the message is called 'Full-screen response', which includes all the fields (input fields and the display fields) as in the corresponding Oracle FLEXCUBE screen.
- AccountStructureModify -Res-PK- This is the response message which is sent back to the external system when an account structure is successfully modified in Oracle FLEXCUBE UBS. The format of the message is called 'Primary-Key response', which includes only the primary key fields of the account structure in the Oracle FLEXCUBE data store.

### **6.2.5.3 AccountStructureQuery**

This is the operation code for querying an account structure in Oracle FLEXCUBE. It involves the following messages:

- AccountStructureQuery-Req-Full- This is the request message to an account structure in Oracle FLEXCUBE UBS. An external system which intends to query an account structure has to send the request in the format specified. The format of the message is called 'Full-screen', which includes all the fields (input fields and the display fields) as in the corresponding Oracle FLEXCUBE front-end screen.
- AccountStructureQuery -Req-IO- This is the request message to query an account structure in Oracle FLEXCUBE UBS. An external system which intends to query an



account structure has to send the request in the specified format. The format of the message is called 'Input-only', which has only those fields that are actually required for querying account structure.

- AccountStructureQuery -Res-Full- This is the response message which is sent back to the external system when an account structure is successfully queried in Oracle FLEXCUBE UBS. The format of the message is called 'Full-screen response', which includes all the fields (input fields and the display fields) as in the corresponding Oracle FLEXCUBE screen.
- AccountStructureQuery -Res-PK- This is the response message which is sent back to the external system when an account structure is successfully queried in Oracle FLEXCUBE UBS. The format of the message is called 'Primary-Key response', which includes only the primary key fields of the account structure in the Oracle FLEXCUBE data store.

#### **6.2.5.4 CreateAmtBlk**

This is the operation code for creating an amount block in Oracle FLEXCUBE. It involves the following messages:

- CreateAmtBlk-Req-Full- This is the request message to create amount block in Oracle FLEXCUBE UBS. An external system which intends to create an amount block has to send the request in the format specified. The format of the message is called 'Full-screen', which includes all the fields (input fields and the display fields) as in the corresponding Oracle FLEXCUBE front-end screen.
- CreateAmtBlk -Req-IO- This is the request message to create an amount block in Oracle FLEXCUBE UBS. An external system which intends to create an amount block has to send the request in the specified format. The format of the message is called 'Input-only', which has only those fields that are actually required for creating amount block.
- CreateAmtBlk -Res-Full- This is the response message which is sent back to the external system when an amount block is successfully created in Oracle FLEXCUBE UBS. The format of the message is called 'Full-screen response', which includes all the fields (input fields and the display fields) as in the corresponding Oracle FLEXCUBE screen.
- CreateAmtBlk-Res-PK- This is the response message which is sent back to the external system when an amount block is successfully created in Oracle FLEXCUBE UBS. The format of the message is called 'Primary-Key response', which includes only the primary key fields of the amount block in the Oracle FLEXCUBE data store.

#### **6.2.5.5 ModifyAmtBlk**

This is the operation code for modifying amount block in Oracle FLEXCUBE. It involves the following messages:

- ModifyAmtBlk-Req-Full- This is the request message to modify an amount block in Oracle FLEXCUBE UBS. An external system which intends to modify an amount block has to send the request in the format specified. The format of the message is called 'Full-screen', which includes all the fields (input fields and the display fields) as in the corresponding Oracle FLEXCUBE front-end screen.
- ModifyAmtBlk-Req-IO- This is the request message to modify an amount block in Oracle FLEXCUBE UBS. An external system which intends to modify an amount block has to send the request in the specified format. The format of the message is called 'Input-only', which has only those fields that are actually required for modifying amount block.
- ModifyAmtBlk -Res-Full- This is the response message which is sent back to the external system when an amount block is successfully modified in Oracle FLEXCUBE UBS. The format of the message is called 'Full-screen response', which includes all the

fields (input fields and the display fields) as in the corresponding Oracle FLEXCUBE screen.

- **ModifyAmtBlk -Res-PK-** This is the response message which is sent back to the external system when an amount block is successfully modified in Oracle FLEXCUBE UBS. The format of the message is called 'Primary-Key response', which includes only the primary key fields of the amount block in the Oracle FLEXCUBE data store.

#### **6.2.5.6 CloseAmtBlk**

This is the operation code for closing amount block in Oracle FLEXCUBE. It involves the following messages:

- **CloseAmtBlk-Req-Full-** This is the request message to close an amount block in Oracle FLEXCUBE UBS. An external system which intends to close an amount block has to send the request in the format specified. The format of the message is called 'Full-screen', which includes all the fields (input fields and the display fields) as in the corresponding Oracle FLEXCUBE front-end screen.
- **CloseAmtBlk-Req-IO-** This is the request message to close an amount block in Oracle FLEXCUBE UBS. An external system which intends to close an amount block has to send the request in the specified format. The format of the message is called 'Input-only', which has only those fields that are actually required for closing amount block.
- **CloseAmtBlk -Res-Full-** This is the response message which is sent back to the external system when an amount block is successfully closed in Oracle FLEXCUBE UBS. The format of the message is called 'Full-screen response', which includes all the fields (input fields and the display fields) as in the corresponding Oracle FLEXCUBE screen.
- **CloseAmtBulk -Res-PK-** This is the response message which is sent back to the external system when an amount block is successfully closed in Oracle FLEXCUBE UBS. The format of the message is called 'Primary-Key response', which includes only the primary key fields of the amount block in the Oracle FLEXCUBE data store.

#### **6.2.5.7 CreateCustomer**

This is the operation code for creating a customer record in Oracle FLEXCUBE. It involves the following messages:

- **CreateCustomer-Req-Full-** This is the request message to create customer record in Oracle FLEXCUBE UBS. An external system which intends to create an amount block has to send the request in the format specified. The format of the message is called 'Full-screen', which includes all the fields (input fields and the display fields) as in the corresponding Oracle FLEXCUBE front-end screen.
- **CreateCustomer -Req-IO-** This is the request message to create customer record in Oracle FLEXCUBE UBS. An external system which intends to create an amount block has to send the request in the specified format. The format of the message is called 'Input-only', which has only those fields that are actually required for creating a customer record.
- **CreateCustomer -Res-Full-** This is the response message which is sent back to the external system when customer record is successfully created in Oracle FLEXCUBE UBS. The format of the message is called 'Full-screen response', which includes all the fields (input fields and the display fields) as in the corresponding Oracle FLEXCUBE screen.
- **CreateCustomer-Res-PK-** This is the response message which is sent back to the external system when a customer record is successfully created in Oracle FLEXCUBE UBS. The format of the message is called 'Primary-Key response', which includes only the primary key fields of the amount block in the Oracle FLEXCUBE data store.

### 6.2.5.8 ModifyCustomer

This is the operation code for modifying a customer record in Oracle FLEXCUBE. It involves the following messages:

- **ModifyCustomer-Req-Full-** This is the request message to modify a customer record in Oracle FLEXCUBE UBS. An external system which intends to modify a customer record has to send the request in the format specified. The format of the message is called 'Full-screen', which includes all the fields (input fields and the display fields) as in the corresponding Oracle FLEXCUBE front-end screen.
- **ModifyCustomer-Req-IO-** This is the request message to modify customer record in Oracle FLEXCUBE UBS. An external system which intends to modify a customer record has to send the request in the specified format. The format of the message is called 'Input-only', which has only those fields that are actually required for modifying a customer record.
- **ModifyCustomer -Res-Full-** This is the response message which is sent back to the external system when a customer record is successfully modified in Oracle FLEXCUBE UBS. The format of the message is called 'Full-screen response', which includes all the fields (input fields and the display fields) as in the corresponding Oracle FLEXCUBE screen.
- **ModifyCustomer -Res-PK-** This is the response message which is sent back to the external system when a customer record is successfully modified in Oracle FLEXCUBE UBS. The format of the message is called 'Primary-Key response', which includes only the primary key fields of the amount block in the Oracle FLEXCUBE data store.

### 6.2.5.9 Authorize Customer

This is the operation code for authorizing the customer record in Oracle FLEXCUBE. It involves the following messages:

- **AuthorizeCustomer-Req-Full-** This is the request message to authorize customer records in Oracle FLEXCUBE UBS. An external system which intends to authorize a record has to send the request in the format specified. The format of the message is called 'Full-screen', which includes all the fields (input fields and the display fields) as in the corresponding Oracle FLEXCUBE front-end screen.
- **AuthorizeCustomer -Req-IO-** This is the request message to authorize customer record in Oracle FLEXCUBE UBS. An external system which intends to authorize a record has to send the request in the specified format. The format of the message is called 'Input-only', which has only those fields that are actually required for creating a customer record.
- **AuthorizeCustomer -Res-Full-** This is the response message which is sent back to the external system when a customer record is successfully authorized in Oracle FLEXCUBE UBS. The format of the message is called 'Full-screen response', which includes all the fields (input fields and the display fields) as in the corresponding Oracle FLEXCUBE screen.
- **AuthorizeCustomer -Res-PK-** This is the response message which is sent back to the external system when a customer record is successfully authorized in Oracle FLEXCUBE UBS. The format of the message is called 'Primary-Key response', which includes only the primary key fields of the customer record authorization in the Oracle FLEXCUBE data store.

### 6.2.5.10 QueryCustomer

This service is used by external channels to query a customer record in Oracle FLEXCUBE:

- **QueryClosureData -Req-IO-** This is the request message to query a customer record in Oracle FLEXCUBE UBS. An external system which intends to query a customer record

has to send the request in the specified format. The format of the message is called 'Input-only', which has only those fields that are actually required for querying a record.

- QueryClosureData -Res-Full- This is the response message which is sent back to the external system when a customer record is successfully queried in Oracle FLEXCUBE UBS. The format of the message is called 'Full-screen response', which includes all the fields (input fields and the display fields) as in the corresponding Oracle FLEXCUBE screen.

#### **6.2.5.11 CreateClosureData**

This is the operation code for creating a record in the 'Customer Closure Data (STSCUSCL) screen in Oracle FLEXCUBE. It involves the following messages:

- CreateClosureData-Req-Full- This is the request message to create a record in the 'Customer Closure Data (STSCUSCL) screen in Oracle FLEXCUBE UBS. An external system which intends to create a virtual account has to send the request in the format specified. The format of the message is called 'Full-screen', which includes all the fields (input fields and the display fields) as in the corresponding Oracle FLEXCUBE front-end screen.
- CreateClosureData -Req-IO- This is the request message to create a record in the 'Customer Closure Data (STSCUSCL) screen in Oracle FLEXCUBE UBS. An external system which intends to create a virtual account has to send the request in the specified format. The format of the message is called 'Input-only', which has only those fields that are actually required for creating a record.
- CreateClosureData -Res-Full- This is the response message which is sent back to the external system when a customer record is successfully created in Oracle FLEXCUBE UBS. The format of the message is called 'Full-screen response', which includes all the fields (input fields and the display fields) as in the corresponding Oracle FLEXCUBE screen.
- CreateClosureData-Res-PK- This is the response message which is sent back to the external system when a customer record is successfully created in the 'Customer Closure Data (STSCUSCL)' screen in Oracle FLEXCUBE UBS. The format of the message is called 'Primary-Key response', which includes only the primary key fields of creating a customer record in the Oracle FLEXCUBE data store.

#### **6.2.5.12 AuthorizeClosureData**

This is the operation code for authorizing a customer record in Oracle FLEXCUBE. It involves the following messages:

- AuthorizeCustomer-Req-Full- This is the request message to authorize customer records in Oracle FLEXCUBE UBS. An external system which intends to authorize a record has to send the request in the format specified. The format of the message is called 'Full-screen', which includes all the fields (input fields and the display fields) as in the corresponding Oracle FLEXCUBE front-end screen.
- AuthorizeClosureData -Req-IO- This is the request message to authorize records in 'Customer Closure Data (STSCUSCL) screen in Oracle FLEXCUBE UBS. An external system which intends to authorize a record has to send the request in the specified format. The format of the message is called 'Input-only', which has only those fields that are actually required for creating a customer record.
- AuthorizeClosureData -Res-Full- This is the response message which is sent back to the external system when a customer record is successfully authorized in 'Customer Closure Data (STSCUSCL) screen in Oracle FLEXCUBE UBS. The format of the message is called 'Full-screen response', which includes all the fields (input fields and the display fields) as in the corresponding Oracle FLEXCUBE screen.
- AuthorizeClosureData -Res-PK- This is the response message which is sent back to the external system when a 'Customer Closure Data (STSCUSCL) screen is successfully

authorized in Oracle FLEXCUBE UBS. The format of the message is called 'Primary-Key response', which includes only the primary key fields of the customer record authorization in the Oracle FLEXCUBE data store.

### **6.2.5.13 ModifyClosureData**

This is the operation code for modifying a record in the 'Customer Closure Data (STSCUSCL) screen' in Oracle FLEXCUBE. Here only the 'Closure Allowed' field can be modified. It involves the following messages:

- **ModifyClosureData-Req-Full-** This is the request message to modify a record in the 'Customer Closure Data (STSCUSCL) screen' in Oracle FLEXCUBE UBS. An external system which intends to modify a record has to send the request in the format specified. The format of the message is called 'Full-screen', which includes all the fields (input fields and the display fields) as in the corresponding Oracle FLEXCUBE front-end screen.
- **ModifyClosureData-Req-IO-** This is the request message to modify a record in the 'Customer Closure Data (STSCUSCL) screen' in Oracle FLEXCUBE UBS. An external system which intends to modify a record has to send the request in the specified format. The format of the message is called 'Input-only', which has only those fields that are actually required for modifying a record.
- **ModifyClosureData -Res-Full-** This is the response message which is sent back to the external system when record is successfully modified in 'Customer Closure Data (STSCUSCL) screen' in Oracle FLEXCUBE UBS. The format of the message is called 'Full-screen response', which includes all the fields (input fields and the display fields) as in the corresponding Oracle FLEXCUBE screen.
- **ModifyClosureData -Res-PK-** This is the response message which is sent back to the external system when a record is successfully modified in Oracle FLEXCUBE UBS. The format of the message is called 'Primary-Key response', which includes only the primary key fields of the record in the Oracle FLEXCUBE data store.

### **6.2.5.14 QueryClosureData**

This service is used by external channels to query closure data in the 'Customer Closure Data (STSCUSCL) screen' in Oracle FLEXCUBE:

- **QueryClosureData -Req-IO-** This is the request message to query a customer closure data details in 'Customer Closure Data (STSCUSCL) screen' in Oracle FLEXCUBE UBS. An external system which intends to query a customer closure data has to send the request in the specified format. The format of the message is called 'Input-only', which has only those fields that are actually required for querying a record.
- **QueryClosureData -Res-Full-** This is the response message which is sent back to the external system when a customer closure record is successfully queried in Oracle FLEXCUBE UBS. The format of the message is called 'Full-screen response', which includes all the fields (input fields and the display fields) as in the corresponding Oracle FLEXCUBE screen.

### **6.2.6 FCUBSTDService**

TD related operations are logically grouped under a service called 'FCUBSTDService'.

Oracle FLEXCUBE supports the following operations under this service:

- CreateTDRRedem
- AuthorizeTDRRedem
- DeleteTDRRedem
- QueryTDRRedem

### 6.2.6.1 CreateTDRedem

This is the operation code for creating a redemption request of TD in Oracle FLEXCUBE. It involves the following messages:

- CreateTDRedem-Req-Full- This is the request message to redeem TD account in Oracle FLEXCUBE UBS. An external system which intends to redeem a TD account has to send the request in the format specified. The format of the message is called 'Full-screen', which includes all the fields (input fields and the display fields) as in the corresponding Oracle FLEXCUBE front-end screen.
- CreateTDRedem -Req-IO- This is the request message to redeem TD account in Oracle FLEXCUBE UBS. An external system which intends to redeem TD account has to send the request in the specified format. The format of the message is called 'Input-only', which has only those fields that are actually required for redeeming a TD.
- CreateTDRedem -Res-Full- This is the response message which is sent back to the external system when a TD account is successfully redeemed in Oracle FLEXCUBE UBS. The format of the message is called 'Full-screen response', which includes all the fields (input fields and the display fields) as in the corresponding Oracle FLEXCUBE screen.
- CreateTDRedem -Res-PK- This is the response message which is sent back to the external system when a TD account is successfully redeemed in Oracle FLEXCUBE UBS. The format of the message is called 'Primary-Key response', which includes only the primary key fields of the redemption in the Oracle FLEXCUBE data store.

### 6.2.6.2 AuthorizeTDRedem

This is the operation code for authorizing redemption request of TD in Oracle FLEXCUBE. It involves the following messages:

- AuthorizeTDRedem-Req-Full- This is the request message to authorize the redemption of TD account in Oracle FLEXCUBE UBS. An external system which intends to authorize the redemption has to send the request in the format specified. The format of the message is called 'Full-screen', which includes all the fields (input fields and the display fields) as in the corresponding Oracle FLEXCUBE front-end screen.
- AuthorizeTDRedem -Req-IO- This is the request message to authorize the redemption of TD account in Oracle FLEXCUBE UBS. An external system which intends to authorize the redemption of TD account has to send the request in the specified format. The format of the message is called 'Input-only', which has only those fields that are actually required for redeeming a TD.
- AuthorizeTDRedem -Res-Full- This is the response message which is sent back to the external system when a TD account is redeemed is successfully authorized in Oracle FLEXCUBE UBS. The format of the message is called 'Full-screen response', which includes all the fields (input fields and the display fields) as in the corresponding Oracle FLEXCUBE screen.
- AuthorizeTDRedem -Res-PK- This is the response message which is sent back to the external system when a TD account redeemed, is authorized in Oracle FLEXCUBE UBS. The format of the message is called 'Primary-Key response', which includes only the primary key fields of the redemption in the Oracle FLEXCUBE data store.

### 6.2.6.3 DeleteTDRedem

This is the operation code for deleting redemption request of TD in Oracle FLEXCUBE. It involves the following messages:

- DeleteTDRedem-Req-Full- This is the request message to delete the redemption of TD account in Oracle FLEXCUBE UBS. An external system which intends to delete the redemption request created has to send the request in the format specified. The format



of the message is called 'Full-screen', which includes all the fields (input fields and the display fields) as in the corresponding Oracle FLEXCUBE front-end screen.

- DeleteTDRedem -Req-IO- This is the request message to delete the redemption of TD account in Oracle FLEXCUBE UBS. An external system which intends to delete the redemption of TD account has to send the request in the specified format. The format of the message is called 'Input-only', which has only those fields that are actually required for redeeming a TD.
- DeleteTDRedem -Res-Full- This is the response message which is sent back to the external system when a redemption request is successfully deleted in Oracle FLEXCUBE UBS. The format of the message is called 'Full-screen response', which includes all the fields (input fields and the display fields) as in the corresponding Oracle FLEXCUBE screen.
- DeleteTDRedem -Res-PK- This is the response message which is sent back to the external system when a redemption request is deleted from Oracle FLEXCUBE UBS. The format of the message is called 'Primary-Key response', which includes only the primary key fields of the redemption in the Oracle FLEXCUBE data store.

#### **6.2.6.4 QueryTDRedem**

This is the operation code for querying TD redemption done in Oracle FLEXCUBE. It involves the following messages:

- QueryTDRedem -Req-IO- This is the request message to query the redemption made to TD account in Oracle FLEXCUBE UBS. An external system which intends to query TD redemption has to send the request in the specified format. The format of the message is called 'Input-only', which has only those fields that are actually required for querying TD redemption.
- QueryTDCustAcc -Res-Full- This is the response message which is sent back to the external system when redemption made to TD account successfully queried in Oracle FLEXCUBE UBS. The format of the message is called 'Full-screen response', which includes all the fields (input fields and the display fields) as in the corresponding Oracle FLEXCUBE screen.

#### **6.2.7 FCUBSPCService**

All PC operations are logically grouped under a service called 'FCUBSPCService'

Oracle FLEXCUBE supports the following operations under this service:

- CreatePTPBen
- ModifyPTPBen
- DeletePTPBen
- AuthPTPBen
- QueryPTPBen
- ClosePTPBen
- ReopenPTPBen

##### **6.2.7.1 CreatePTPBen**

This is the operation code for creating P2P beneficiary account in Oracle FLEXCUBE. It involves the following messages:

- CreatePTPBen-Req-Full- This is the request message to create P2P beneficiary account in Oracle FLEXCUBE. An external system which intends to create P2P beneficiary account has to send the request in the format specified. The format of the

message is called 'Full-screen', which includes all the fields (input fields and the display fields) as in the corresponding Oracle FLEXCUBE front-end screen.

- **CreatePTPBen-Req-IO**- This is the request message to create P2P beneficiary account in Oracle FLEXCUBE UBS. An external system which intends to create P2P beneficiary account has to send the request in the specified format. The format of the message is called 'Input-only', which has only those fields that are actually required for creating P2P Beneficiary account.
- **CreatePTPBen-Res-Full**- This is the response message which is sent back to the external system when a P2P beneficiary account is successfully created in Oracle FLEXCUBE UBS. The format of the message is called 'Full-screen response', which includes all the fields (input fields and the display fields) as in the corresponding Oracle FLEXCUBE screen.
- **CreatePTPBen-Res-PK**- This is the response message which is sent back to the external system when a P2P beneficiary account is successfully created in Oracle FLEXCUBE UBS. The format of the message is called 'Primary-Key response', which includes only the primary key fields of the P2P beneficiary account in the Oracle FLEXCUBE data store.

### **6.2.7.2 ModifyPTPBen**

This is the operation code for modifying P2P beneficiary account in Oracle FLEXCUBE. It involves the following messages:

- **ModifyPTPBen-Req-Full**- This is the request message to modify P2P beneficiary account in Oracle FLEXCUBE UBS. An external system which intends to modify a P2P beneficiary account has to send the request in the format specified. The format of the message is called 'Full-screen', which includes all the fields (input fields and the display fields) as in the corresponding Oracle FLEXCUBE front-end screen.
- **ModifyPTPBen-Req-IO**- This is the request message to modify P2P beneficiary account in Oracle FLEXCUBE UBS. An external system which intends to modify an P2P beneficiary account has to send the request in the specified format. The format of the message is called 'Input-only', which has only those fields that are actually required for modifying P2P beneficiary account.
- **ModifyPTPBen-Res-Full**- This is the response message which is sent back to the external system when P2P beneficiary account is successfully modified in Oracle FLEXCUBE UBS. The format of the message is called 'Full-screen response', which includes all the fields (input fields and the display fields) as in the corresponding Oracle FLEXCUBE screen.
- **ModifyPTPBen-Res-PK**- This is the response message which is sent back to the external system when P2P beneficiary account is successfully modified in Oracle FLEXCUBE UBS. The format of the message is called 'Primary-Key response', which includes only the primary key fields of the P2P beneficiary account in the Oracle FLEXCUBE data store.

### **6.2.7.3 DeletePTPBen**

This is the operation code for deleting P2P beneficiary account in Oracle FLEXCUBE. It involves the following messages:

- **DeletePTPBen-Req-Full**- This is the request message to delete P2P beneficiary account in Oracle FLEXCUBE UBS. An external system which intends to delete P2P beneficiary account has to send the request in the format specified. The format of the message is called 'Full-screen', which includes all the fields (input fields and the display fields) as in the corresponding Oracle FLEXCUBE front-end screen.
- **DeletePTPBen-Req-IO**- This is the request message to delete P2P beneficiary account in Oracle FLEXCUBE UBS. An external system which intends to delete a P2P beneficiary account has to send the request in the specified format. The format of the



message is called 'Input-only', which has only those fields that are actually required for closing P2P beneficiary account.

- DeletePTPBen-Res-Full- This is the response message which is sent back to the external system when P2P beneficiary account is successfully deleted in Oracle FLEXCUBE UBS. The format of the message is called 'Full-screen response', which includes all the fields (input fields and the display fields) as in the corresponding Oracle FLEXCUBE screen.
- DeletePTPBen-Res-PK- This is the response message which is sent back to the external system when P2P beneficiary account is successfully deleted in Oracle FLEXCUBE UBS. The format of the message is called 'Primary-Key response', which includes only the primary key fields of the P2P beneficiary account in the Oracle FLEXCUBE data store.

#### **6.2.7.4 AuthPTPBen**

This is the operation code for authorizing P2P beneficiary account in Oracle FLEXCUBE. It involves the following messages:

- AuthPTPBen-Req-Full- This is the request message to authorize the P2P beneficiary account in Oracle FLEXCUBE UBS. An external system which intends to authorize the redemption has to send the request in the format specified. The format of the message is called 'Full-screen', which includes all the fields (input fields and the display fields) as in the corresponding Oracle FLEXCUBE front-end screen.
- AuthPTPBen -Req-IO- This is the request message to authorize the P2P beneficiary account in Oracle FLEXCUBE UBS. An external system which intends to authorize the P2P beneficiary account has to send the request in the specified format. The format of the message is called 'Input-only', which has only those fields that are actually required for P2P beneficiary account.
- AuthPTPBen -Res-Full- This is the response message which is sent back to the external system when a P2P beneficiary account is successfully authorized in Oracle FLEXCUBE UBS. The format of the message is called 'Full-screen response', which includes all the fields (input fields and the display fields) as in the corresponding Oracle FLEXCUBE screen.
- AuthPTPBen -Res-PK- This is the response message which is sent back to the external system when a P2P beneficiary account, is authorized in Oracle FLEXCUBE UBS. The format of the message is called 'Primary-Key response', which includes only the primary key fields of the P2P beneficiary account in the Oracle FLEXCUBE data store.

#### **6.2.7.5 QueryPTPBen**

This is the operation code for querying P2P beneficiary account done in Oracle FLEXCUBE. It involves the following messages:

- QueryPTPBen -Req-IO- This is the request message to query the P2P beneficiary account in Oracle FLEXCUBE UBS. An external system which intends to query P2P beneficiary account has to send the request in the specified format. The format of the message is called 'Input-only', which has only those fields that are actually required for querying P2P beneficiary account.
- QueryPTPBen -Res-Full- This is the response message which is sent back to the external system when P2P beneficiary account is successfully queried in Oracle FLEXCUBE UBS. The format of the message is called 'Full-screen response', which includes all the fields (input fields and the display fields) as in the corresponding Oracle FLEXCUBE screen.

#### **6.2.7.6 ClosePTPBen**

This is the operation code for closing P2P beneficiary account in Oracle FLEXCUBE.

### 6.2.7.7 ReopenPTPBen

This is the operation code for reopening P2P beneficiary account in Oracle FLEXCUBE.

### 6.2.8 FCUBSExtPCService

Oracle FLEXCUBE supports the following operations under this service:

- CreatePTPPrm
- ModifyPTPPrm
- DeletePTPPrm
- AuthPTPPrm
- QueryPTPPrm
- ClosePTPPrm
- ReopenPTPPrm

#### 6.2.8.1 CreatePTPPrm

This is the operation code for creating P2P payment parameters in Oracle FLEXCUBE. It involves the following messages:

- CreatePTPPrm-Req-Full- This is the request message to create P2P payment parameters in Oracle FLEXCUBE. An external system which intends to create P2P payment parameters has to send the request in the format specified. The format of the message is called 'Full-screen', which includes all the fields (input fields and the display fields) as in the corresponding Oracle FLEXCUBE front-end screen.
- CreatePTPPrm-Req-IO- This is the request message to create P2P payment parameters in Oracle FLEXCUBE. An external system which intends to create P2P payment parameters has to send the request in the specified format. The format of the message is called 'Input-only', which has only those fields that are actually required for creating P2P payment parameters.
- CreatePTPPrm-Res-Full- This is the response message which is sent back to the external system when a P2P payment parameters is successfully created in Oracle FLEXCUBE. The format of the message is called 'Full-screen response', which includes all the fields (input fields and the display fields) as in the corresponding Oracle FLEXCUBE screen.
- CreatePTPPrm-Res-PK- This is the response message which is sent back to the external system when a P2P payment parameters is successfully created in Oracle FLEXCUBE. The format of the message is called 'Primary-Key response', which includes only the primary key fields of the P2P payment parameters in the Oracle FLEXCUBE data store.

#### 6.2.8.2 ModifyPTPPrm

This is the operation code for modifying P2P payment parameters in Oracle FLEXCUBE. It involves the following messages:

- ModifyPTPPrm-Req-Full- This is the request message to modify P2P payment parameters in Oracle FLEXCUBE. An external system which intends to modify a P2P payment parameters has to send the request in the format specified. The format of the message is called 'Full-screen', which includes all the fields (input fields and the display fields) as in the corresponding Oracle FLEXCUBE front-end screen.
- ModifyPTPPrm-Req-IO- This is the request message to modify P2P payment parameters in Oracle FLEXCUBE. An external system which intends to modify a P2P payment parameters has to send the request in the specified format. The format of the

message is called 'Input-only', which has only those fields that are actually required for modifying P2P payment parameters.

- **ModifyPTPPrm-Res-Full-** This is the response message which is sent back to the external system when P2P payment parameters is successfully modified in Oracle FLEXCUBE. The format of the message is called 'Full-screen response', which includes all the fields (input fields and the display fields) as in the corresponding Oracle FLEXCUBE screen.
- **ModifyPTPPrm-Res-PK-** This is the response message which is sent back to the external system when P2P payment parameters is successfully modified in Oracle FLEXCUBE. The format of the message is called 'Primary-Key response', which includes only the primary key fields of the P2P payment parameters in the Oracle FLEXCUBE data store.

### **6.2.8.3 DeletePTPPrm**

This is the operation code for deleting P2P payment parameters in Oracle FLEXCUBE. It involves the following messages:

- **DeletePTPPrm-Req-Full-** This is the request message to delete P2P payment parameters in Oracle FLEXCUBE. An external system which intends to delete P2P payment parameters has to send the request in the format specified. The format of the message is called 'Full-screen', which includes all the fields (input fields and the display fields) as in the corresponding Oracle FLEXCUBE front-end screen.
- **DeletePTPPrm-Req-IO-** This is the request message to delete P2P payment parameters in Oracle FLEXCUBE. An external system which intends to delete a P2P payment parameters has to send the request in the specified format. The format of the message is called 'Input-only', which has only those fields that are actually required for closing P2P payment parameters.
- **DeletePTPPrm-Res-Full-** This is the response message which is sent back to the external system when P2P payment parameters is successfully deleted in Oracle FLEXCUBE. The format of the message is called 'Full-screen response', which includes all the fields (input fields and the display fields) as in the corresponding Oracle FLEXCUBE screen.
- **DeletePTPPrm-Res-PK-** This is the response message which is sent back to the external system when P2P payment parameters is successfully deleted in Oracle FLEXCUBE. The format of the message is called 'Primary-Key response', which includes only the primary key fields of the P2P beneficiary account in the Oracle FLEXCUBE data store.

### **6.2.8.4 AuthPTPPrm**

This is the operation code for authorizing P2P payment parameters in Oracle FLEXCUBE. It involves the following messages:

- **AuthPTPPrm-Req-Full-** This is the request message to authorize the P2P payment parameters in Oracle FLEXCUBE. An external system which intends to authorize the redemption has to send the request in the format specified. The format of the message is called 'Full-screen', which includes all the fields (input fields and the display fields) as in the corresponding Oracle FLEXCUBE front-end screen.
- **AuthPTPPrm -Req-IO-** This is the request message to authorize the P2P payment parameters in Oracle FLEXCUBE. An external system which intends to authorize the P2P payment parameters has to send the request in the specified format. The format of the message is called 'Input-only', which has only those fields that are actually required for P2P payment parameters.
- **AuthPTPPrm -Res-Full-** This is the response message which is sent back to the external system when a P2P payment parameters is successfully authorized in Oracle FLEXCUBE. The format of the message is called 'Full-screen response', which includes

all the fields (input fields and the display fields) as in the corresponding Oracle FLEXCUBE screen.

- AuthPTPPrm -Res-PK- This is the response message which is sent back to the external system when a P2P payment parameters, is authorized in Oracle FLEXCUBE. The format of the message is called 'Primary-Key response', which includes only the primary key fields of the P2P payment parameters in the Oracle FLEXCUBE data store.

#### **6.2.8.5 QueryPTPPrm**

This is the operation code for querying P2P payment parameters done in Oracle FLEXCUBE. It involves the following messages:

- QueryPTPPrm -Req-IO- This is the request message to query the P2P payment parameters in Oracle FLEXCUBE. An external system which intends to query P2P payment parameters has to send the request in the specified format. The format of the message is called 'Input-only', which has only those fields that are actually required for querying P2P payment parameters.
- QueryPTPPrm -Res-Full- This is the response message which is sent back to the external system when P2P payment parameters is successfully queried in Oracle FLEXCUBE. The format of the message is called 'Full-screen response', which includes all the fields (input fields and the display fields) as in the corresponding Oracle FLEXCUBE screen.

#### **6.2.8.6 ClosePTPPrm**

This is the operation code for closing P2P payment parameters in Oracle FLEXCUBE.

#### **6.2.8.7 ReopenPTPPrm**

This is the operation code for reopening P2P payment parameters in Oracle FLEXCUBE.

### **6.2.9 FCUBSIFService**

Oracle FLEXCUBE supports the following operations under this service:

- CreateExtAccEntries
- ReverseExtAccEntries

#### **6.2.9.1 CreateExtAccEntries**

This is the operation code is for initiating debit or credit settlement transactions in Oracle FLEXCUBE. It involves the following messages:

- CreateExtAccEntries-Req-Full- This is the request message to create debit or credit settlement transactions in Oracle FLEXCUBE. An external system which intends to create debit or credit settlement transactions has to send the request in the format specified. The format of the message is called 'Full-screen', which includes all the fields (input fields and the display fields) as in the corresponding Oracle FLEXCUBE front-end screen.
- CreateExtAccEntries-Req-IO- This is the request message to create debit or credit settlement transactions in Oracle FLEXCUBE. An external system which intends to create debit or credit settlement transactions has to send the request in the specified format. The format of the message is called 'Input-only', which has only those fields that are actually required for creating debit or credit settlement transactions.
- CreateExtAccEntries-Res-Full- This is the response message which is sent back to the external system when a debit or credit settlement transaction is successfully created in Oracle FLEXCUBE. The format of the message is called 'Full-screen response',

which includes all the fields (input fields and the display fields) as in the corresponding Oracle FLEXCUBE screen.

- CreateExtAccEntries-Res-PK- This is the response message which is sent back to the external system when debit or credit settlement transaction is successfully created in Oracle FLEXCUBE. The format of the message is called 'Primary-Key response', which includes only the primary key fields of the debit or credit settlement transactions in the Oracle FLEXCUBE data store.

### **6.2.9.2 ReverseExtAccEntries**

This is the operation code is for reversing debit or credit settlement transactions in Oracle FLEXCUBE. It involves the following messages:

- ReverseExtAccEntries-Req-Full- This is the request message to reverse debit or credit settlement transactions in Oracle FLEXCUBE. An external system which intends to reverse debit or credit settlement transactions has to send the request in the format specified. The format of the message is called 'Full-screen', which includes all the fields (input fields and the display fields) as in the corresponding Oracle FLEXCUBE front-end screen.
- ReverseExtAccEntries-Req-IO- This is the request message to reverse debit or credit settlement transactions in Oracle FLEXCUBE. An external system which intends to reverse debit or credit settlement transactions has to send the request in the specified format. The format of the message is called 'Input-only', which has only those fields that are actually required for creating debit or credit settlement transactions.
- ReverseExtAccEntries-Res-Full- This is the response message which is sent back to the external system when a debit or credit settlement transaction is successfully reverse in Oracle FLEXCUBE. The format of the message is called 'Full-screen response', which includes all the fields (input fields and the display fields) as in the corresponding Oracle FLEXCUBE screen.
- ReverseExtAccEntries-Res-PK- This is the response message which is sent back to the external system when debit or credit settlement transaction is successfully reversed in Oracle FLEXCUBE. The format of the message is called 'Primary-Key response', which includes only the primary key fields of the debit or credit settlement transactions in the Oracle FLEXCUBE data store.

### **6.2.10 FCUBSInteractionservice**

Oracle FLEXCUBE supports the following operations under this service:

- CreateSpendClass
- ModifySpendClass
- CloseSpendClass
- ReopenSpendClass
- ModifySpEntryClass

#### **6.2.10.1 CreateSpendClass**

This is the operation code for creating spend class in Oracle FLEXCUBE. It involves the following messages:

- CreateSpendClass-Req-Full- This is the request message to create spend class in Oracle FLEXCUBE. An external system which intends to create debit or credit settlement transactions has to send the request in the format specified. The format of the message is called 'Full-screen', which includes all the fields (input fields and the display fields) as in the corresponding Oracle FLEXCUBE front-end screen.

- **CreateSpendClass-Req-IO-** This is the request message to create spend class in Oracle FLEXCUBE. An external system which intends to create spend class has to send the request in the specified format. The format of the message is called 'Input-only', which has only those fields that are actually required for creating spend class.
- **CreateSpendClass-Res-Full-** This is the response message which is sent back to the external system when a spend class is successfully created in Oracle FLEXCUBE. The format of the message is called 'Full-screen response', which includes all the fields (input fields and the display fields) as in the corresponding Oracle FLEXCUBE screen.
- **CreateSpendClass-Res-PK-** This is the response message which is sent back to the external system when spend class is successfully created in Oracle FLEXCUBE. The format of the message is called 'Primary-Key response', which includes only the primary key fields of the spend class in the Oracle FLEXCUBE data store.

### **6.2.10.2 ModifySpendClass**

This is the operation code for modifying spend class parameters in Oracle FLEXCUBE. It involves the following messages:

- **ModifySpendClass-Req-Full-** This is the request message to modify spend class parameters in Oracle FLEXCUBE. An external system which intends to modify spend class parameters has to send the request in the format specified. The format of the message is called 'Full-screen', which includes all the fields (input fields and the display fields) as in the corresponding Oracle FLEXCUBE front-end screen.
- **ModifySpendClass-Req-IO-** This is the request message to modify spend class parameters in Oracle FLEXCUBE. An external system which intends to modify spend class parameters has to send the request in the specified format. The format of the message is called 'Input-only', which has only those fields that are actually required for modifying spend class parameters.
- **ModifySpendClass-Res-Full-** This is the response message which is sent back to the external system when spend class parameters are successfully modified in Oracle FLEXCUBE. The format of the message is called 'Full-screen response', which includes all the fields (input fields and the display fields) as in the corresponding Oracle FLEXCUBE screen.
- **ModifySpendClass-Res-PK-** This is the response message which is sent back to the external system when spend class parameters are successfully modified in Oracle FLEXCUBE. The format of the message is called 'Primary-Key response', which includes only the primary key fields of the spend class parameters in the Oracle FLEXCUBE data store.

### **6.2.10.3 CloseSpendClass**

This is the operation code for closing spend class in Oracle FLEXCUBE.

### **6.2.10.4 ReopenSpendClass**

This is the operation code for reopening spend class parameters in Oracle FLEXCUBE.

### **6.2.10.5 ModifySpEntryClass**

This is the operation code for splitting transactions in Oracle FLEXCUBE.

---

# 7. Planned Outage Support Server

## 7.1 Introduction

Planned Outage Support Server (POSS) is the data replica of the host server and facilitates the channels to support the database server without any downtime during the planned outages.

When POSS is active:

- EOD will not run
- Non-Channel Interface has to be switched off.
- ELCM enterprise has to be switched off.
- Messaging and notification cannot be done.

A new server state XML is created for which the path is decided based on the entry in the properties file. The XML will contain a parameter <SERVERSTATE> which can have any of the following values:

- A – Available
- S – Sleep
- U – Unavailable
- R - Replay

Gateway EJB will take the request information from the SSB when the full session bean retains the information.

## 7.2 Handling Planned Outages

The various stages of planned outages are described as below:

### 7.2.1 Host Up

When the request comes from the channel, it will reach the Gateway EJB or MDB and the bean check for the state of server. If the server state is 'A' (Available), the bean picks up the JNDI host server details from the properties file and add a parameter to the xml which implies that the request is being served at the host.

Then the request will be processed at the back end and the response from the back end will reach the bean and then to the endpoint.

### 7.2.2 Outage Start

Using the restore point, the request data will be synchronized from host server to POSS. Before the planned outage, the server state has to be changed into 'S' (Sleep) from 'A' to indicate that the server will be down as soon as the synchronization starts.

During synchronization, if any new request comes to the bean, the gateway layer will reject the request and a XML error message will be generated. Once the synchronization is completed, the server state will be changed into 'U' (Unavailable) which indicates the bean that the host server is down and from then on any request that comes will be processed at POSS.



### **7.2.3 Host Down and POSS Up:**

When the host is down and POSS is up, the server state will be 'U'. During this time, all the requests that reach the bean will be served at POSS. The bean picks up the JNDI details of POSS from the properties file, establishes a connection, and sends the request which will be logged into a table at the backend.

The log table will have details which will indicate if:

- the response has been built successfully
- the request has to be replayed at the host during replay
- any error has occurred and oracle SCN

The response is sent back to the bean which will send the response to the end point.

### **7.2.4 Host Up, Start Replay from POSS:**

Once the host is up, a 'REPLAY ROUTINE' (which is a java routine) is carried out which consists of the following steps:

- The server state will be changed from 'U' to 'R' (Replay mode).
- The replay routine will get the requests from the log table at POSS for which response building has been completed and these will be replayed to the host.
- The replay routine logs all message logs and places the message onto Oracle AQ on the Host database.
- Multiple processes, equal to the number of locks defined, start the request processing based on SCN.
- Each process will replay the requests on to the host by calling a procedure in the service router.
- Once a record is replayed, the thread updates the log table indicating that the replay of this record is complete.

When the server state is 'R' and any new request comes to the bean, it will execute a DAO to check for records in POSS that need to be replayed to the host. If any such record is found, the new request is sent to POSS else the server state is changed from 'R' to 'A'.

When the server state is 'R' the bean also slows down the processing of new requests to ensure there is a switch over back to host.



The following chart will depict a clear picture of request information that pass on to the various stages that are discussed.

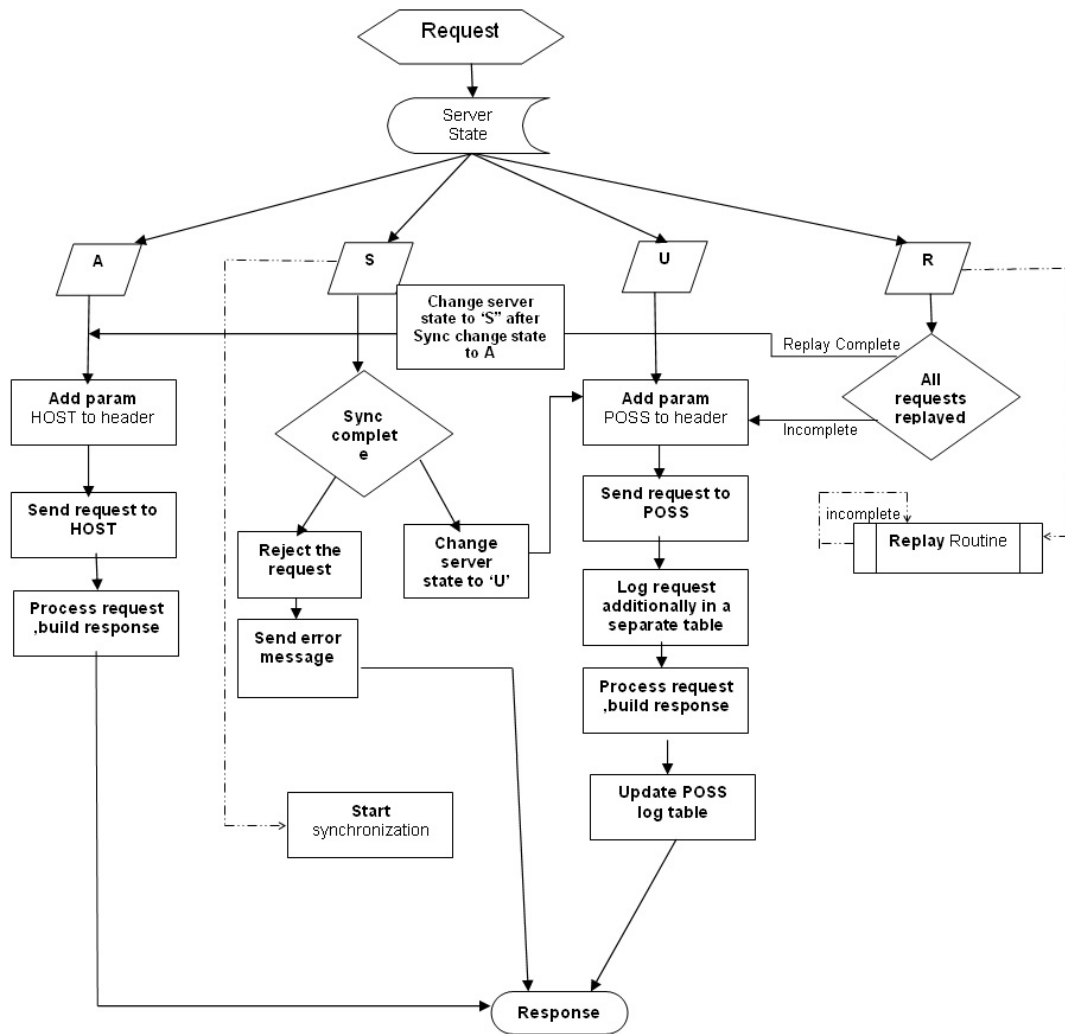

### 7.2.5 ELCM Impact

When the request comes, two ELCM gateways are deployed pointing towards the Host and the POSS. The external interface at ELCM will be switched off and the transactions which are initiated through FLEXCUBE will be serviced.

## 7.3 Services Supported during Outage

The following Services are supported during Planned Outage:

### 7.3.1 FCUBSFT Service

The operations that are supported under FCUBSFT services are:

- Cancel FT Contract
- Create FT Contract

### 7.3.2 FCUBSPC Service

The operations that are supported under FCUBSFT services are:

- Create PC Contract
- Create PC Maint
- Close PC Contract
- Create PC ClientAgg

### **7.3.3 FCUBSSI Service**

The operations that are supported under FCUBSSI services are:

- Create SI Contract
- Close SI Contract

### **7.3.4 FCUBSTD Service**

The operations that are supported under FCUBSTD services are:

- Create TDAcc
- Query TDRedemption

### **7.3.5 FCUBSCL Service**

The FCUBSCL services support the 'Save Payment' operation.

### **7.3.6 FCUBSLD Service**

The operations that are supported under FCUBSLD services are:

- Create LD Contract
- Create LD Payment

### **7.3.7 FCUBSAcc Service**

The operations that are supported under FCUBSAcc services are:

- Create CustAcc
- Check Book New

### **7.3.8 FCUBS Customer Service**

The operations that are supported under FCUBS Customer services are:

- Create Customer
- Modify Customer
- Modify CustAcc
- Query CustAcc

### **7.3.9 FCUBSIL Service**

The operations that are supported under FCUBSIL services are:

- Close ILSweep
- Delete ILSweep
- Query ILSweep
- Modify ILSweep
- Create ILSweep

- Close ILGroup
- Delete ILGroup
- Query ILGroup
- Modify ILGroup
- Create ILGroup

### **7.3.10 FCUBSLC Service**

The operations that are supported under FCUBSLC services are:

- Create LCContract
- Modify LCContract

### **7.3.11 FCUBSFX Service**

The FCUBSFX services support the 'Create FX Contract' operation.

### **7.3.12 FCUBSCG Service**

The FCUBSCG services support the 'Create Stop Payment' operation.

### **7.3.13 FCUBSSwitch Service**

The FCUBSSwitch services support the 'Switch Transaction' operation.

---

## 8. Function ID Glossary

### C

CODSORCE ..... 3-6  
CODUPLDM ..... 3-7

### G

GWDEXSYS ..... 3-1  
GWDINBRW ..... 3-10  
GWDNTFEN ..... 3-21  
GWDNTFIN ..... 3-19  
GWDOTBRW ..... 3-16

GWSEXFUN ..... 3-5  
GWSEXSYS ..... 3-3  
GWSINBRW ..... 3-12  
GWSNTFEN ..... 3-22  
GWSNTFIN ..... 3-20  
GWSOTBRW ..... 3-18  
GWSPBROW ..... 3-13, 3-15

### S

STDGWINT ..... 3-23