

# mitsubishi

# MES Interface Module

User's Manual  
(Hardware)

## QJ71MES96

Thank you for purchasing the Mitsubishi programmable controller MELSEC-Q Series.

Prior to use, please read both this manual and detailed manual thoroughly to fully understand the product.

**MELSEC-Q**  
Mitsubishi Programmable  
Controller

Model	QJ71MES96-U-HW
MODEL CODE	13JY02
IB(NA)-0800354-C(0809)MEE	

## ● SAFETY PRECAUTIONS ●



(Always read these precautions before using this equipment.)

Before using this product, please read this manual and the relevant manuals introduced in this manual carefully and pay full attention to safety to handle the product correctly.

Note that these precautions apply only to this product.

For the safety precautions of the programmable controller system, please read the User's Manual for the CPU module used.

In this manual, the safety instructions are ranked as "DANGER" and "CAUTION".

 <b>DANGER</b>	Indicates that incorrect handling may cause hazardous conditions, resulting in death or severe injury.
 <b>CAUTION</b>	Indicates that incorrect handling may cause hazardous conditions, resulting in medium or slight personal injury or physical damage.

Note that the  CAUTION level may lead to a serious consequence according to the circumstances.

Always follow the instructions of both levels because they are important to personal safety.

Please save this manual to make it accessible when required and always forward it to the end user.

## [Design Precautions]

### DANGER

- When controlling a running programmable controller (e.g. data modification), create an interlock circuit on sequence programs so that the whole system functions safely all the time.  
Also, be sure to read the manual carefully and ensure safety before performing any other controls such as operating status change.  
Especially, when controlling a programmable controller from a remote location via network, problems on the programmable controller side may not be dealt with promptly due to failure of data communications.  
Create an interlock circuit on a sequence program.
- For the operation status of each station at a communication error, refer to the manual for that station.  
Incorrect output or malfunctions may cause an accident.
- Install a safety circuit external to the programmable controller that keeps the entire system safe even when there are problems with the external power supply or the programmable controller.  
Otherwise, trouble could result from erroneous output or erroneous operation.
- When the programmable controller system security needs to be protected against illegal access from an external device via a network, take measures at the user's discretion.
- Do not write any data to the "System area" in the buffer memory of the intelligent function module.  
As for signals output from the programmable controller CPU to the intelligent function module, never output (ON) a "Use prohibited" signal.  
Doing these operations may cause malfunctions of the programmable controller system.

## [Design Precautions]

### CAUTION

- Do not bunch the control wires or communication cables with the main circuit or power wires, or install them close to each other.  
They should be installed 100 mm (3.94 inch) or more from each other.  
Not doing so could result in noise that would cause erroneous operation.
- During registering each setting, do not power OFF the mounted module or reset the programmable controller CPU.  
Otherwise, data in the CompactFlash card will be undefined. Therefore, resetting and re-registering data are required.  
This may also cause a module failure or malfunctions.

## [Installation Precautions]

### CAUTION

- Use the programmable controller under the environment specified in the User's Manual.  
Using this programmable controller in an environment outside the range of the general specifications could result in electric shock, fire, erroneous operation, and damage to or deterioration of the product.
- While pressing the installation lever located at the bottom of module, insert the module fixing tab into the fixing hole in the base unit until it stops. Then, securely mount the module with the fixing hole as a supporting point.  
Incorrect loading of the module can cause a malfunction, failure or drop.  
When using the programmable controller in the environment of much vibration, tighten the module with a screw.

## [Installation Precautions]

### CAUTION

- Completely turn off the externally supplied power used in the system before mounting or removing the module.  
Not doing so could result in damage to the product.
- Tighten the screw in the specified torque range.  
Undertightening can cause a drop, short circuit or malfunction.  
Overtightening can cause a drop, short circuit or malfunction due to damage to the screw or module.
- Do not directly touch the module's conductive parts or electronic components.  
Touching the conductive parts could cause an operation failure or give damage to the module.
- When connecting a connector, properly press, crimp, or solder it using the tools specified by the manufacturer.  
Incomplete connection may cause short-circuit, fire, and malfunctions.
- Push the CompactFlash card into the CompactFlash card slot and install it securely.  
After installing the CompactFlash card, check that it is inserted securely.  
Failure to do so may cause malfunctions due to poor contact.

## [Wiring Precautions]

### CAUTION

- Always store the communication cables and power cables connected to the module in the duct or fix them in place with clamps.  
Not doing so may cause swing, move, or poor connection of the cable, or damage of a module and/or cable due to careless pull, resulting in malfunctions.
- Install connectors securely to modules.

## [Wiring Precautions]

### CAUTION

- Tighten the screw in the specified torque range.  
Undertightening can cause a drop, short circuit or malfunction.  
Overtightening can cause a drop, short circuit or malfunction due to damage to the screw or module.
- When disconnecting communication cables connected to the module, never pull on the cable section.  
When using a cable with a connector, disconnect it with holding the connector connected to the module.  
When the cable is pulled while connected to the module, this may cause malfunctions or module/cable damage.
- Be sure there are no foreign substances such as sawdust or wiring debris inside the module.  
Such debris could cause fires, damage, or erroneous operation.
- The module has an ingress prevention label on its top to prevent foreign matter, such as wire offcuts, from entering the module during wiring.  
Do not peel this label during wiring.  
Before starting system operation, be sure to peel this label because of heat dissipation.

## [Disposal Precautions]

### CAUTION

- When disposing of this product, treat it as industrial waste.  
When disposing of batteries, separate them from other wastes according to the local regulations. (For details of the battery directive in EU member states, refer to the MES Interface Module User's Manual.)

## [Transportation Precautions]

### CAUTION

- When transporting lithium batteries, make sure to treat them based on the transportation regulations. (Refer to Chapter 8 for details of the relevant models.)

## Revisions

\* The manual number is given on the bottom right of the front cover.

Print date	* Manual number	Revision
Jul., 2006	IB(NA)-0800354-A	First edition
Dec., 2007	IB(NA)-0800354-B	<p>Change of a term</p> <p>"PLC" was changed to "programmable controller".</p> <p>Correction</p> <p>SAFETY PRECAUTIONS, Chapter1, Section3.1</p>
Sep., 2008	IB(NA)-0800354-C	<p>Correction</p> <p>About Manual, Compliance with the EMC and Low Voltage Directives, Section3.1</p>

This manual confers no industrial property rights or any rights of any other kind, nor does it confer any patent licenses. Also, Mitsubishi Electric Corporation cannot be held responsible for any problems involving industrial property rights which may occur as a result of using the contents in this manual.

© 2006 MITSUBISHI ELECTRIC CORPORATION

---

---

# CONTENTS

---

---

1. OVERVIEW .....	1
2. PERFORMAMNCE SPECIFICATIONS .....	2
3. LOADING AND INSTALLATION .....	3
3.1 Handling Precautions .....	3
3.2 Installation Environment .....	3
4. PART NAMES .....	4
5. EXTERNAL WIRING .....	6
5.1 Connecting to the 10BASE-T/100BASE-TX .....	6
6. SETTING FROM GX DEVELOPER .....	7
7. EXTERNAL DIMENSIONS .....	9
8. TRANSPORTATION PRECAUTIONS.....	10
8.1 Controlled Model .....	10
8.2 Handling for Shipping .....	10



## **About Manual**

The following manual is also related to this product.  
In necessary, order it by quoting the details in the table below.

Related Manual
----------------

Manual name	Manual No. (Model code)
MES Interface Module User's Manual	SH-080644ENG (13JR95)

## **Compliance with the EMC and Low Voltage Directives**

- (1) For programmable controller system  
To configure a system meeting the requirements of the EMC and Low Voltage Directives when incorporating the Mitsubishi programmable controller (EMC and Low Voltage Directives compliant) into other machinery or equipment, refer to Chapter 9 "EMC AND LOW VOLTAGE DIRECTIVES" of the QCPU User's Manual (Hardware Design, Maintenance and Inspection).  
The CE mark, indicating compliance with the EMC and Low Voltage Directives, is printed on the rating plate of the programmable controller.
- (2) For the product  
For the compliance of this product with the EMC and Low Voltage Directives, refer to Section 9.1.3 "Cables" in Chapter 9 "EMC AND LOW VOLTAGE DIRECTIVES" of the QCPU User's Manual (Hardware Design, Maintenance and Inspection).

---

---

## 1. OVERVIEW

---

---

This manual explains how to install the QJ71MES96 MES interface module (hereafter, abbreviated as MES interface module) and how to wire them with other devices.

(Packing list)

Model	Product name	Quantity
QJ71MES96	QJ71MES96 MES interface module	1
	Battery (Q6BAT)	1

## 2. PERFORMANCE SPECIFICATIONS

The following describes the performance specifications of the MES interface module.

For general specifications of the MES interface module, refer to the following manual.

 QCPU User's Manual (Hardware Design, Maintenance and Inspection)

Item		Specifications	
Ethernet	Interface*1	10BASE-T	100BASE-TX
	Data transmission rate	10 Mbps	100 Mbps
	Transmission method	Base band	
	No. of cascaded stages	Maximum 4 stages	Maximum 2 stages
	Max. segment length*2	100 m	
	Supported function	The auto-negotiation function is available. (automatically distinguishes 10BASE-T from 100BASE-TX)	
CompactFlash card	Supply power voltage	3.3V±5%	
	Supply power capacity	Maximum 150 mA	
	Card size	TYPE I card	
	No. of installable cards	1	
Number of occupied I/O points		32 points/slot (I/O assignment: Intelli. 32 points)	
Clock		The clock data is obtained from a programmable controller CPU (in multiple CPU system, CPU No.1) or the SNTP server computer.	
5VDC internal current consumption		0.65A	
External dimensions		98 (3.86) (H)× 27.4 (1.08) (W)× 90(3.54) (D) [mm (inch)]	
Weight		0.16kg	

\*1 The MES interface module distinguishes 10BASE-T from 100BASE-TX depending on the device on other end.

For connection with a hub not having the auto-negotiation function, set the hub side to half-duplex auto communication mode.

\*2 Distance between a hub and node.

---

---

## 3. LOADING AND INSTALLATION

---

---

### 3.1 Handling Precautions

- (1) Do not drop or apply severe shock to the module case since it is made of resin.
- (2) Before touching the module, always touch grounded metal, etc. to discharge static electricity from human body, etc.  
Not doing so can cause the module to fail or malfunction.
- (3) Tighten the module fixing screws within the following range.

Screw	Tightening torque range
Module fixing screw (usually not required) (M3 screw) <sup>*1</sup>	0.36 to 0.48 N•m

- \*1 The module can be easily fixed onto the base unit using the hook at the top of the module.

However, it is recommended to secure the module with the module fixing screw if the module is subject to significant vibration.

### 3.2 Installation Environment

For details, refer to the user's manual for the CPU module used.

## 4. PART NAMES

(1) With the LED cover closed

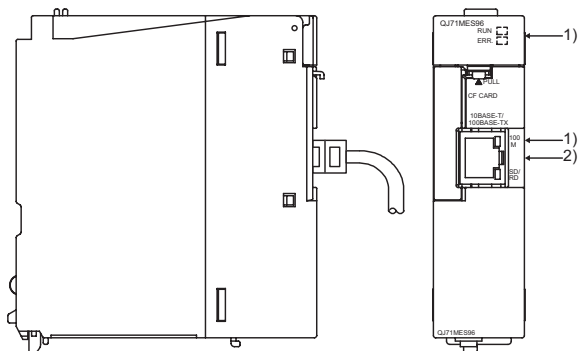

(2) With the LED cover open

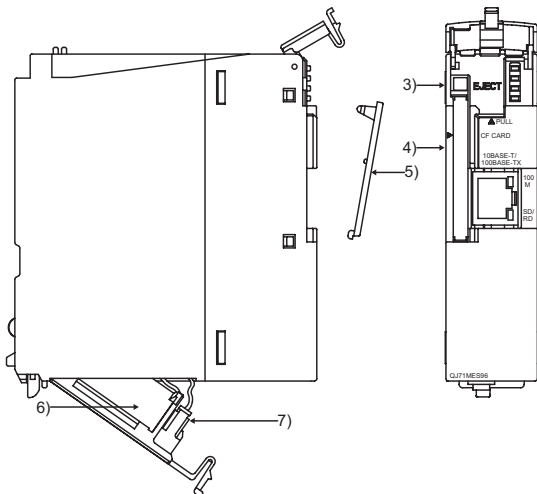

	Name	Description
1)	Indicator LED	Refer to (3) Indicator LED display contents.
2)	10BASE-T/100BASE-TX interface connector (RJ45)	Used for connecting the MES interface module in 10BASE-T/100BASE-TX connection. (The MES interface module distinguishes 10BASE-T from 100BASE-TX depending on the device on other end.)
3)	EJECT button	Used for ejecting a CompactFlash card from the MES interface module.
4)	CompactFlash card slot	Used for installing a CompactFlash card to the MES interface module.
5)	CompactFlash card slot cover	Cover for the CompactFlash card slot
6)	Battery	Battery for file protection
7)	Battery connector pin	Connector pin for battery lead (The battery lead is disconnected from the connector at shipment to prevent battery consumption.)

### (3) Indicator LED display contents

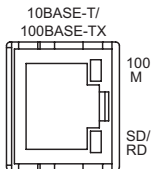
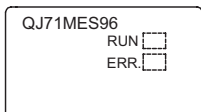

Name	LED status	Description
RUN	ON	In normal operation (It may take some time until the RUN LED is turned ON after the module is started.)
	OFF	Watchdog timer error (Hardware error)
ERR.	OFF	In normal status
	ON	Module continuation error
	Flash	Module stop error
100 M	ON	100 Mbps
	OFF	10 Mbps
SD/RD	ON	During data send or data receive
	OFF	Data not transmitted

---

---

## 5. EXTERNAL WIRING

---

---

### 5.1 Connecting to the 10BASE-T/100BASE-TX

When connecting to the 10BASE-T/100BASE-TX interface, use twisted pair cable.

Use twisted pair cable that meets IEEE802.3 10BASE-T/100BASE-TX standards.

- (1) For 100 Mbps  
Either (a) or (b) of the following can be used.
  - (a) Unshielded twisted pair cable (UTP cable), Category 5
  - (b) Shielded twisted pair cable (STP cable), Category 5
- (2) For 10 Mbps  
Either (a) or (b) of the following can be used.
  - (a) Unshielded twisted pair cable (UTP cable), Category 3 (4, 5)
  - (b) Shielded twisted pair cable (STP cable), Category 3 (4, 5)

POINT
<p>During high speed communication (100 Mbps) via 100BASE-TX connection, communication errors may occur due to the effect of high frequency noise generated from the equipment other than programmable controller, depending on the installation environment.</p> <p>Take the following countermeasures on the MES interface module side to eliminate the effect of high frequency noise when constructing the network system.</p> <ol style="list-style-type: none"><li>(1) Wiring<ul style="list-style-type: none"><li>• Do not install the twisted pair cables together with the main circuit or power lines, or bring them close to each other.</li><li>• Make sure to place the twisted pair cable in a duct.</li></ul></li><li>(2) Cable<ul style="list-style-type: none"><li>• In the environment where the cable is susceptible to noise, use the shielded twisted pair cable (STP cable).</li></ul></li><li>(3) 10 Mbps communication<ul style="list-style-type: none"><li>• Connect the 10 Mbps-compatible equipment with the MES interface module and transmit the data to the equipment at a transmission speed of 10 Mbps.</li></ul></li></ol>

- (1) Wiring

- Do not install the twisted pair cables together with the main circuit or power lines, or bring them close to each other.
- Make sure to place the twisted pair cable in a duct.

- (2) Cable

- In the environment where the cable is susceptible to noise, use the shielded twisted pair cable (STP cable).

- (3) 10 Mbps communication

- Connect the 10 Mbps-compatible equipment with the MES interface module and transmit the data to the equipment at a transmission speed of 10 Mbps.

## 6. SETTING FROM GX DEVELOPER

The intelligent function module switches are used to make the mode setting, default operation setting, battery error detection setting, and response monitoring time setting.

Switch number	Description
Switch 1	Mode setting
Switch 2	Default operation setting/battery error detection setting
Switch 3 (Lower byte)	Response monitoring time setting
Switch 4 to 5	For system use (Do not set.)

### (1) Mode setting (Switch 1)

Select the MES interface module operation mode.

Setting number	Item	Description
0000h	Online	Normal operation mode
0001h	Hardware test	Tests the ROM/RAM/intelligent function module switch settings.
0002h	Self-loopback test	Executes the 10BASE-T/100BASE-TX interface self-diagnostics test.

### (2) Default operation setting/battery error detection setting (Switch 2)

Select the default operation setting/battery error detection setting for the MES interface module.

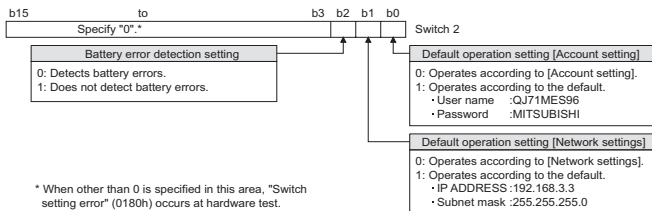



- (a) Default operation setting (bit 0, 1)  
Set whether to operate [Account setting] and [Network settings] with their default.
- 1) [Account setting] (bit 0)
    - 0: Operates according to [Account setting].
    - 1: Operates according to the default.
  - 2) [Network settings] (bit 1)
    - 0: Operates according to [Network settings].
    - 1: Operates according to the default.
- (b) Battery error detection setting (bit 2)  
Set whether to detect battery errors while the MES interface module is operating without battery.
- 0: Detects battery errors.
  - 1: Does not detect battery errors.
- (3) Response monitoring time setting (Switch 3 (Lower byte))  
Set the timeout time (Second) from when the MES interface module sends a request to the access target CPU until receiving the reply.  
A response time-out error (0002h) occurs if the access target CPU does not respond within the set time.

Setting range: 15 to 255 (Second) (Default value: 15 seconds)  
When setting the time between 0 and 14 or making no settings, response monitoring time operates with 15 seconds.

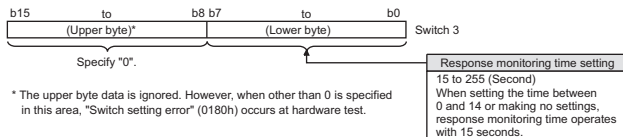

## 7. EXTERNAL DIMENSIONS

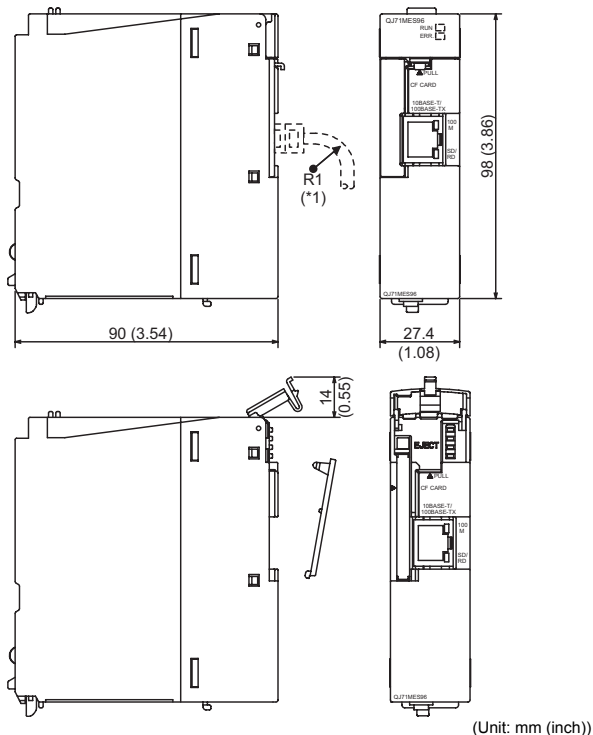

- \*1 The bending radius near the connector ( $R1$ : yardstick) should be at least four times longer than the cable's outside diameter when the twisted pair cable is connected.

---

---

## 8. TRANSPORTATION PRECAUTIONS

---

---

When transporting a battery containing lithium, handling according to transportation regulations is required.

### 8.1 Controlled Model

The lithium battery used in the MES interface module is classified as follows.

Product name	Model	Product supply status	Classification for transportation
Q series battery	Q6BAT	Lithium battery	Non-hazardous material

### 8.2 Handling for Shipping

The products are packed in accordance with transportation regulations before shipment. When transporting products after repacking or unpacking them, make them comply with the IATA Dangerous Goods Regulations, IMDG Code, and national transportation regulations. For details, consult with the shipping carrier.

CompactFlash is a trademark of SanDisk Corporation. All other company names and product names used in this manual are trademarks or registered trademarks of their respective companies.
---

## Warranty

Mitsubishi will not be held liable for damage caused by factors found not to be the cause of Mitsubishi; machine damage or lost profits caused by faults in the Mitsubishi products; damage, secondary damage, accident compensation caused by special factors unpredictable by Mitsubishi; damages to products other than Mitsubishi products; and to other duties.

### For safe use

- This product has been manufactured as a general-purpose part for general industries, and has not been designed or manufactured to be incorporated in a device or system used in purposes related to human life.
- Before using the product for special purposes such as nuclear power, electric power, aerospace, medicine or passenger movement vehicles, consult with Mitsubishi.
- This product has been manufactured under strict quality control. However, when installing the product where major accidents or losses could occur if the product fails, install appropriate backup or failsafe functions in the system.

Country/Region	Sales office/Tel	Country/Region	Sales office/Tel
U.S.A	Mitsubishi Electric Automation Inc. 500 Corporate Woods Parkway Vernon Hills, IL 60061, U.S.A. Tel : +1-847-478-2100	Hong Kong	Mitsubishi Electric Automation (Hong Kong) Ltd. 10th Floor, Manulife Tower, 169 Electric Road, North Point, Hong Kong Tel : +852-2887-8870
Brazil	MELCO-TEC Rep. Com.e Assessoria Tecnica Ltda. Rua Correia Dias, 184, Edificio Paraiso Trade Center-8 andar Paraiso, Sao Paulo, SP Brazil Tel : +55-11-5908-8331	China	Mitsubishi Electric Automation (Shanghai) Ltd. 4/F Zhi Fu Plaza, No.80 Xin Chang Road, Shanghai 200003, China Tel : +86-21-6120-0808
Germany	Mitsubishi Electric Europe B.V. German Branch Gothaer Strasse 8 D-40880 Ratingen, GERMANY Tel : +49-2102-486-0	Taiwan	Setsumo Enterprise Co., Ltd. 6F No.105 Wu-Kung 3rd.Rd, Wu-Ku Hsiang, Taipei Hsine, Taiwan Tel : +886-2-2299-2499
U.K	Mitsubishi Electric Europe B.V. UK Branch Travellers Lane, Hatfield, Hertfordshire., AL10 8XB, U.K. Tel : +44-1707-276100	Korea	Mitsubishi Electric Automation Korea Co., Ltd. 1480-6, Gayang-dong, Gangseo-ku Seoul 157-200, Korea Tel : +82-2-3660-9552
Italy	Mitsubishi Electric Europe B.V. Italian Branch Centro Dir. Colleoni, Pal. Perseo-Ingr.2 Via Paracelso 12, I-20041 Agrate Brianza., Milano, Italy Tel : +39-039-60531	Singapore	Mitsubishi Electric Asia Pte, Ltd. 307 Alexandra Road #05-01/02, Mitsubishi Electric Building, Singapore 159943 Tel : +65-6470-2460
Spain	Mitsubishi Electric Europe B.V. Spanish Branch Carretera de Rubi 76-80, E-08190 Sant Cugat del Valles, Barcelona, Spain Tel : +34-93-565-3131	Thailand	Mitsubishi Electric Automation (Thailand) Co., Ltd. Bang-Chan Industrial Estate No.111 Moo 4, Serithai Rd, T.Kannayao, A.Kannayao, Bangkok 10230 Thailand Tel : +66-2-517-1326
France	Mitsubishi Electric Europe B.V. French Branch 25, Boulevard des Bouvets, F-92741 Nanterre Cedex, France TEL: +33-1-5568-5568	Indonesia	P.T. Autoteknindo Sumber Makmur Muara Karang Selatan, Block A/Utara No.1 Kav. No.11 Kawasan Industri Pergudangan Jakarta - Utara 14440, P.O.Box 5045 Jakarta, 11050 Indonesia Tel : +62-21-6630833
South Africa	Circuit Breaker Industries Ltd. Private Bag 2016, ZA-1600 Isando, South Africa Tel : +27-11-928-2000	India	Messung Systems Pvt. Ltd. Electronic Sadan NO:III Unit No15, M.I.D.C Bhosari, Pune-411026, India Tel : +91-20-2712-3130
		Australia	Mitsubishi Electric Australia Pty. Ltd. 348 Victoria Road, Rydalmere, N.S.W 2116, Australia Tel : +61-2-9684-7777

## MITSUBISHI ELECTRIC CORPORATION

HEAD OFFICE : TOKYO BUILDING, 2-7-3 MARUNOUCHI, CHIYODA-KU, TOKYO 100-8310, JAPAN  
NAGOYA WORKS : 1-14, YADA-MINAMI 5-CHOME, HIGASHI-KU, NAGOYA, JAPAN

When exported from Japan, this manual does not require application to the Ministry of Economy, Trade and Industry for service transaction permission.

Specifications subject to change without notice.  
Printed in Japan on recycled paper.