

What's in the box?

Electric
Water Heater

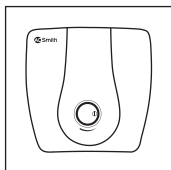

User
Manual

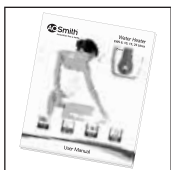

Wall Mounting
Accessory

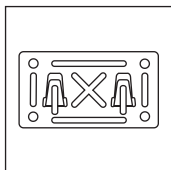

Safety Valve

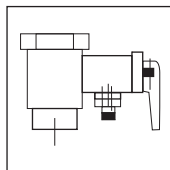

Drain Pipe

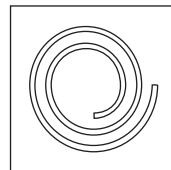

A.O. Smith ColourMatch System™ Optional



The product in the box has a decorative front panel to match the colour of the water heater.

The A.O. Smith ColourMatch System™ allows your water heater to match the colours of your home.

Call the A.O. Smith Customer Care Centre [1.800.103.2468] to order one of the decorative front panel colour options and we will have it delivered free of charge.



White



Blue



Steel Grey



Lavender



Ivory



Red Brick



Olive



Brown

Contents

Specifications	2
Key Features	3
Glass Coated Element	
Blue Diamond Glass Lining	
Anode Rod Protection	
Safety Valve	
Thermal Cutout	
Installation	4
Mounting	
Plumbing	
Electrical Connections	
Water Filling	
Operation Instructions	5
Maintenance and Cleaning	6
Changing the Decorative Front Panel	6
Troubleshooting	7
Circuit Diagram	7
Warranty	8

Specifications

Model	EWS-6	EWS-10	EWS-15	EWS-25
Capacity [ltrs.]	6	10	15	25
Power Supply	← 230V / 50Hz →			
Wattage [kW]	2	2	2	2
Max Stdg. Loss [kWh/24h/45°C diff.] [as per ISI 2082:1993 amended in 2002]	0.792	0.99	1.138	1.386
Actual Stdg. Loss [kWh/24h/45°C diff.]	0.51	0.62	0.75	0.924
Reheating Time for 50°C rise [in min]	16	33	48	72

Dimensions and Parts

Model	EWS-6	EWS-10	EWS-15	EWS-25
A [mm]	317	373	373	444
B1 [mm]	317	373	373	444
B2 [mm]	326	380	382	453
C [mm]	258	277	348	383

Part Descriptors	
1 Outlet	8 Anode
2 Inlet	9 Heating Element
3 Safety Valve	10 Tank
4 Thermostat Knob	11 Installation Bracket
5 Decorative Front Panel	12 PU Insulation
6 Front Jacket	13 Thermal Cutout
7 Back Jacket	

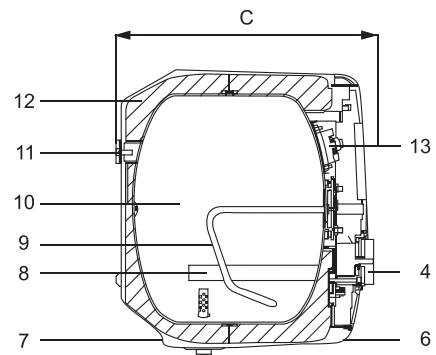
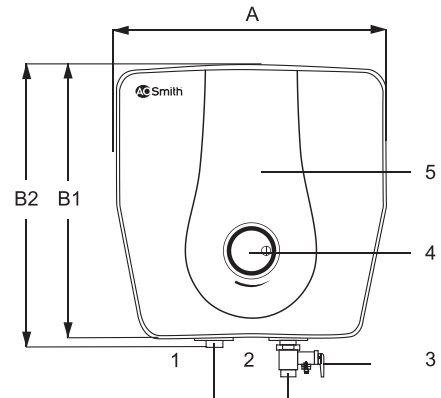

Key Features

Glass Coated Element reduces electricity bills and increases the life of the heating element



Scale and sediment build up on the surface of standard elements leading to higher electricity bills and premature failure. An A. O. Smith Glass Coated Element helps to prevent scale formation on the element reducing your electricity bill and extending the life of the element.

Blue Diamond Glass Lining offers the best protection against tank corrosion



The new Blue Diamond technology with enhanced levels of zircon increases the life of the water heater. The lining is proven to be stronger and more water-resistant than any other in the industry.

Anode Rod protects the tank from corrosion



The tank has an anode rod system with a stainless-core that is designed to protect the tank from corrosive elements. The system uses a special cathodic action to fight the corrosive elements which in turn prolongs the life of the water heater.

Safety Valve discharges water in case pressure or temperature exceeds preset limits



This water heater has a temperature and pressure safety valve. This valve is designed to automatically relieve and discharge water incase the pressure or temperature overshoots the preset limits.

Thermal Cutout cuts off live line and zero line, in case of fault, ensuring safety

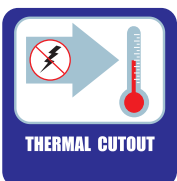

The breaker rapidly cuts off live line and zero line simultaneously to guarantee safety, in case the water heater happens to be faulty and water temperature exceeds the highest temperature preset in the thermostat.

Installation

Mounting

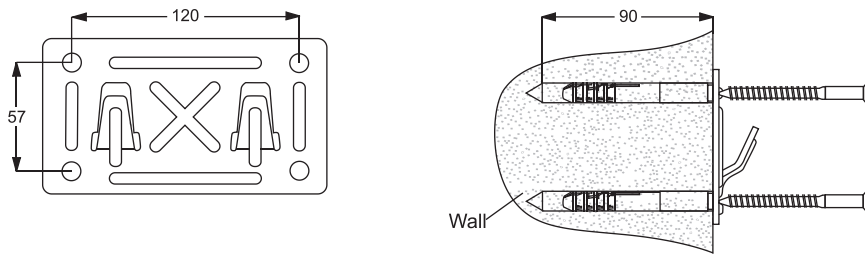

- 1 Make sure that the wall can withstand at least twice the weight of water heater when completely filled with water.
- 2 Before locating the position for installation, make sure that there is a clearance of no less than 300 mm between the front of the heater and the wall. This allows easy opening of the decorative front panel for maintenance or to reset the thermal cutout when necessary.
- 3 Use a drill bit with diameter of 10mm to drill 4 holes at least 90mm deep in the wall. The four holes should be aligned horizontally and vertically. The horizontal distance between the 2 holes should be 120mm and the vertical distance should be 57mm as shown in the above diagram.
- 4 Insert the expansion anchors into the holes. Place the wall bracket over the expansion anchors and screw the four screws tight against the bracket.
- 5 Hang the water heater using the hanger hooks on the wall, through the 4 holes on its mounting bracket. Move the water heater downward to ensure that the holes are pressed against the root of the hanger hooks and ensure the water heater is fixed steadily.

Plumbing

- 1 Make necessary plumbing with reference to the installation diagram on the right page.
- 2 Connect the safety valve in the water inlet [blue]. It must be installed at the side of the inlet pipe. It has been factory set at 0.8 MPa and is not adjustable. The discharge tube of this valve must face downward and the discharged water must be piped up to or within 15cm above a suitable drain. Under any circumstances, the drain line cannot be blocked and must be open to atmosphere.

Attention: The direction of arrow points to the water heater that indicates the direction of the water flow current.

- 3 Connect the hot water pipe to the outlet [red].

Attention: Make sure a suitable sealing tape is used for all connections to prevent leakage. Meanwhile, the safety valve must not be screwed too tight to prevent damage.

Electrical Connections

The power cord and plug are connected with this water heater. Find a separate socket for power plug and make sure the socket is in contact with the plug.

Filling Water

- 1 Open a hot water faucet nearby to permit the air to escape.
- 2 Open the cold-water inlet valve fully, filling the heater and the piping.
- 3 Close the hot-water faucet when water flows.
- 4 Check all the connections to see if there is any leak. In case of a leak, drain the heater completely, repair the leaking joint and then refill the heater.

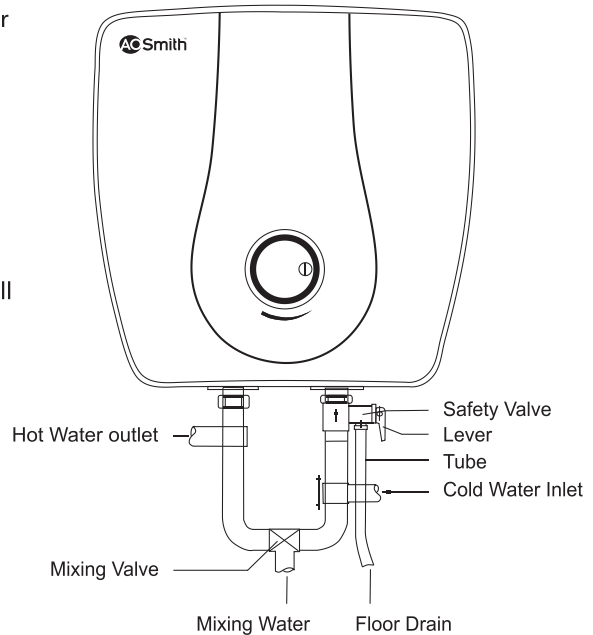

Operation Instructions

- 1 Switch on the water heater's power supply. The yellow indicator light comes on.
- 2 Turn the thermostat knob clockwise for the device to commence heating and change the set temperature. A red light will come on. The set temperature increases if the thermostat knob is turned clockwise. Temperature can be set in the range of 25°C to 75°C.
- 3 The red light's switching off indicates the heater has been heated to the set temperature.

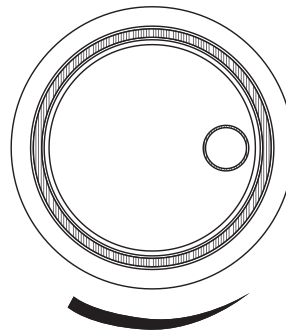

Maintenance and Cleaning

Check proper functioning of the safety valve every two months by opening and closing the test lever. The heating element should be checked annually for scale formation, caused by impurities in the water supply. Also, the anode should be checked annually and replaced when worn out over 60%. For cleaning the element or replacing the anode use the following procedure:

- 1 Switch off the electric supply to the water heater.
- 2 Open the hot water taps until the water is not hot any more.
- 3 Close cold water supply.
- 4 Drain the water heater by removing the safety valve in the direction of the arrow as indicated in the diagram shown along side and open the hot water taps.
- 5 Take off the water heater from the hanger hook, when the water heater is empty.
- 6 Remove the decorative front panel, unscrew the heating assembly flange.
- 7 Clean the container and the heating element assembly from scale by using a suitable acid or by gently scraping the scale.
- 8 Replace anode if required.
- 9 Remount the heating assembly flange.
- 10 Hang the water heater on the hanger hook on the wall through the 2 holes of its mounting bracket. Move the water heater downward to ensure that the holes are pressed against the root of the hanger hooks and ensure the water heater is fixed steadily.
- 11 Open cold water supply until water flows without interruption from hot water faucets.
- 12 Close the hot water taps and check for eventual leakage around the flange.
- 13 When there is no leakage, replace the decorative front panel. Then switch on electric supply.

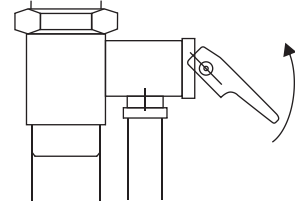

Changing the Decorative Front Panel

Pull out the Knob

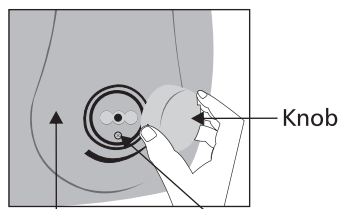

Decorative Front Panel Knob Screw

Unscrew

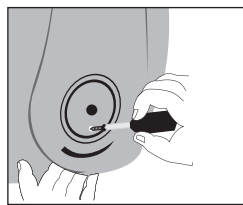

Remove the Decorative Front panel to change

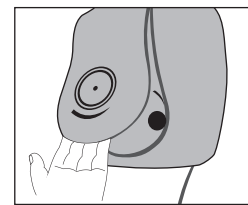

Troubleshooting

Problem	Cause(s)	Action
Yellow and Red light off No hot water	No power to heater	Turn on electrical switch. Check for blown fuses or tripped breaker
	Thermal cutout switch open	Reset. Check for source of trouble and correct
	Control circuit or internal wiring error	Call Customer Care Center on 1.800.103.2468
Yellow light on Red light off No hot water	Non-functioning thermostat	
	Control circuit or internal wiring error	Call Customer Care Center on 1.800.103.2468
Water temperature is too high	Thermostat set is too high	Thermostat to be replaced Call Customer Care Center on 1.800.103.2468
	Thermal cutout trips	Call Customer Care Center on 1.800.103.2468
Water heats slowly	Non-functioning element	Element to be replaced Call Customer Care Center on 1.800.103.2468
Thermostat does not shut off	Non-functioning thermostat	Thermostat to be replaced Call Customer Care Center on 1.800.103.2468
	Improper calibration	Thermostat to be replaced Call Customer Care Center on 1.800.103.2468
Piping connection leaks	Connection not sealed	Re-connect piping, using sealing tape
Leaky cover	Tank or parts leak	Shut off power immediately and Call Customer Care Center on 1.800.103.2468

Circuit Diagram

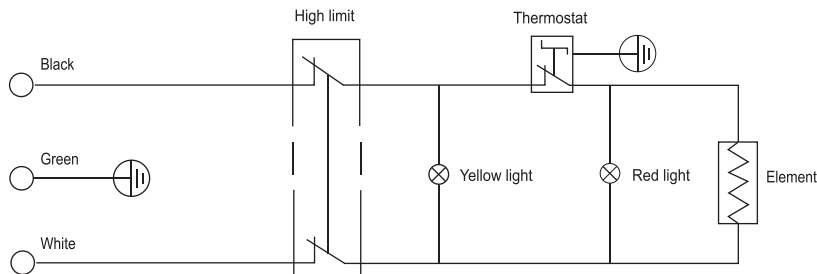

Warranty

- 1 Shall any part or component other than the tank and the heating element be proved defective in material or workmanship within two years after initial installation date, upon examination by A. O. Smith or local authorized agent, A. O. Smith will repair or supply such part or component through the local agent.
- 2 Shall the tank fail due to rust, corrosion or leakage, within seven years of initial installation; A. O. Smith will replace the tank free of cost.
- 3 The warranty only applies if:
 - a. The water heater has been installed as per these instructions.
 - b. Maintenance has been carried out as instructed.
 - c. Safety valves and anodes have been kept in right working condition.
- 4 The warranty is void if:
 - a. The tank has been damaged by external causes.
 - b. In case of misuse, neglect or incorrect use of the water heater.
 - c. In case of any unauthorized alteration, modification or repair.
- 5 The tank carries a warranty for 7 years and the heating element for 4 years [2 + 2 years]. 2 years additional warranty on heating element after registration within two months of purchase. The rest of the parts carry a warranty of 2 years.



Register your product with the A. O. Smith Customer Care Centre [1.800.103.2468] within two months of purchase. You will get an extended warranty on the element [from 2 years to 4 years]. You can also get an additional changeable Decorative Front Panel in a color of your choice, without cost.



T: 1.800.103.2468 www.aosmithindia.com