

MODELS BT- 80 AND 100 300/301 SERIES

COMMERCIAL GAS WATER HEATER

Glass-Lined Tank-Type Water Heater

• INSTALLATION • OPERATION • SERVICE • MAINTENANCE • LIMITED WARRANTY



Thank you for buying this energy efficient water heater from A.O. Smith Water Products Company. We appreciate your confidence in our products.

WARNING: If the information in these instructions is not followed exactly, a fire or explosion may result causing property damage, personal injury or death.

- Do not store or use gasoline or other flammable vapors and liquids in the vicinity of this or any other appliance.
- **WHAT TO DO IF YOU SMELL GAS**
 - Do not try to light any appliance.
 - Do not touch any electrical switch; do not use any phone in your building.
 - Immediately call your gas supplier from a neighbor's phone. Follow the gas supplier's instructions.
 - If you cannot reach your gas supplier, call the fire department.
- Installation and service must be performed by a qualified installer, service agency or the gas supplier.



CAUTION
TEXT IN BLACK BOLD TYPE OR UNDERLINED
CONTAINS INFORMATION RELATIVE TO YOUR
SAFETY. PLEASE READ THOROUGHLY BEFORE
INSTALLING AND USING THIS APPLIANCE.

A.O. Smith
Water Heaters

McBEE, SOUTH CAROLINA, USA
www.aosmithwaterheaters.com

PLACE THESE INSTRUCTIONS ADJACENT TO HEATER
AND NOTIFY OWNER TO KEEP FOR FUTURE REFERENCE.

ROUGH-IN DIMENSIONS

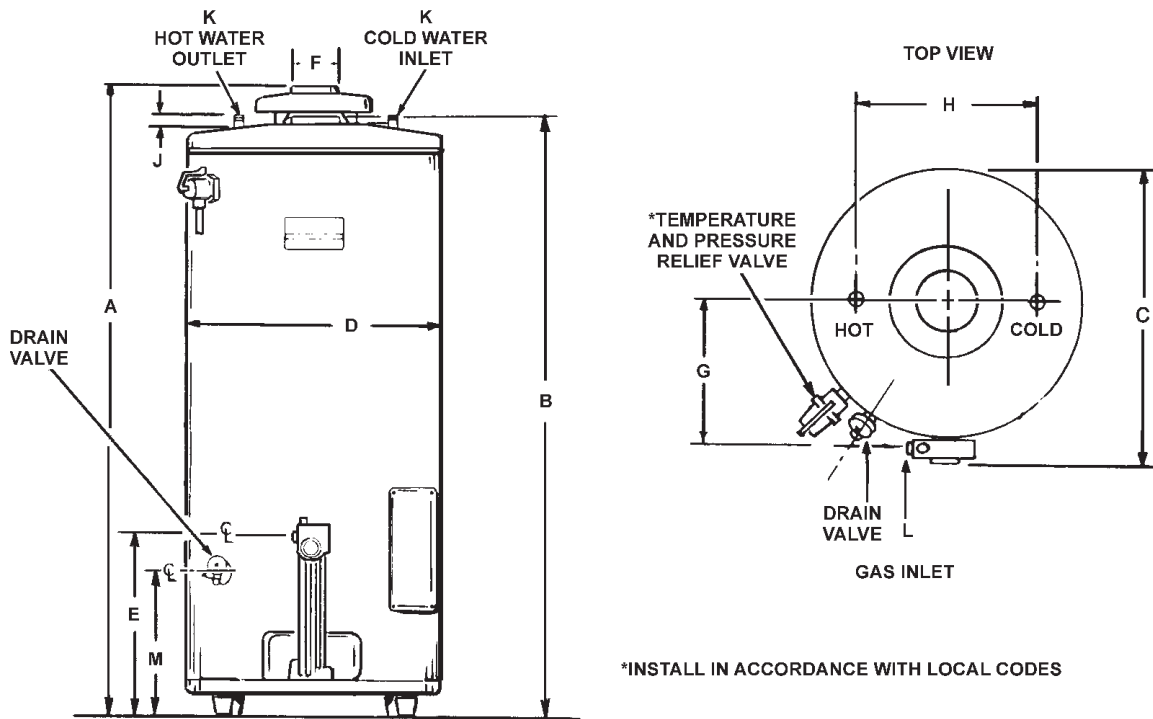

FIGURE 1.

DIMENSIONS

| Model | Units | A | B | C | D | E | F | G | H | J | K | L | M |
|------------------------|--------|--------|--------|----------|--------|---------|------|--------|------|-------|-------|-----|----------|
| BT-80 Natural & LP | Inches | 61 1/8 | 58 1/2 | 29 11/16 | 26 1/2 | 15 3/16 | 4 | 14 1/2 | 16 | 1 1/4 | 1 | 1/2 | 11 15/16 |
| | C M | 155.25 | 148.6 | 75.4 | 67.3 | 38.6 | 10.2 | 39.4 | 40.6 | 3.2 | NPT | NPT | 30.3 |
| BT-100 Natural & LP | Inches | 68 5/8 | 66 1/2 | 30 15/16 | 27 3/4 | 15 3/16 | 4 | 15 3/4 | 16 | 1 1/4 | 1 1/4 | 1/2 | 11 15/16 |
| | CM | 174.3 | 168.9 | 78.59 | 70.5 | 38.6 | 10.2 | 40.0 | 40.6 | 3.2 | NPT | NPT | 30.3 |

RECOVERY RATINGS

| Model | Input | | Approx. Gal. Cap. | Approx. Liter Cap. | Temp. Rise | C° | | | | | | | | | | | | | |
|---------|------------------|--------------|-------------------------|--------------------------|---------------|-----|-----|-----|-----|-----|-----|-----|-----|-----|-----|-----|-----|--|--|
| | Rating Btu/Hr | Rating kW | | | | 17 | 22 | 28 | 33 | 39 | 44 | 50 | 56 | 61 | 67 | 72 | 78 | | |
| BT- 80 | 75,100 | 22.0 | 74 | 280 | GPH | 30 | 40 | 50 | 60 | 70 | 80 | 90 | 100 | 110 | 120 | 130 | 140 | | |
| | | | | | | 243 | 182 | 146 | 121 | 104 | 91 | 81 | 73 | 66 | 61 | 56 | 52 | | |
| BT -100 | 75,100 | 22.0 | 98 | 371 | LPH | 916 | 686 | 550 | 456 | 392 | 343 | 305 | 275 | 249 | 230 | 211 | 196 | | |
| | | | | | | 243 | 182 | 146 | 121 | 104 | 91 | 81 | 73 | 66 | 61 | 56 | 52 | | |
| BT -100 | 75,100 | 22.0 | 98 | 371 | GPH | 916 | 686 | 550 | 456 | 392 | 343 | 305 | 275 | 249 | 230 | 211 | 196 | | |
| | | | | | | 243 | 182 | 146 | 121 | 104 | 91 | 81 | 73 | 66 | 61 | 56 | 52 | | |
| BT -100 | 75,100 | 22.0 | 98 | 371 | LPH | 916 | 686 | 550 | 456 | 392 | 343 | 305 | 275 | 249 | 230 | 211 | 196 | | |
| | | | | | | 243 | 182 | 146 | 121 | 104 | 91 | 81 | 73 | 66 | 61 | 56 | 52 | | |

Recovery ratings based on 80% thermal efficiency.

FOREWORD

The design of models BT-80 and 100 comply with the current edition of ANSI Z21.10.3-CSA 4.3 as automatic storage or automatic circulating tank type water heaters.

Installation diagrams are found in this manual. These diagrams will serve to provide the installer with a reference for the materials and method of piping necessary. It is highly essential that all water and gas piping be installed as shown on the diagrams.

In addition to these instructions, the equipment shall be installed in

accordance with those installation regulations in force in the local area where the installation is to be made. These shall be carefully followed in all cases. Authorities having jurisdiction should be consulted before installations are made.

In the absence of local codes, the installation must comply with the current edition of the National Fuel Gas Code, ANSI Z223.1/NFPA 54 or the Natural Gas and Propane Installation Code CAN/CSA-B149.1. These documents are available from the Canadian Standards Association, 8501 East Pleasant Valley Road, Cleveland, OH 44131.

TABLE OF CONTENTS

| | Page | | Page |
|---|------|--|-------|
| ROUGH-IN DIMENSIONS | 2 | OPERATION | 9-13 |
| FOREWORD | 2 | To Operate The Water Heater | 9 |
| GENERAL SAFETY INFORMATION | 3-4 | Purging | 9 |
| Precautions | 3 | Lighting Instructions | 10-11 |
| Chemical Vapor Corrosion | 3 | Temperature Regulation | 12 |
| Improper Combustion | 3 | Check Venting | 12-13 |
| Liquid Petroleum Models | 3-4 | High Temperature Limit Switch | 13 |
| Extended Non-use Periods | 4 | SERVICE INFORMATION | 13-14 |
| Insulation Blankets | 4 | Pilot and Main Burner | 13 |
| Circulating Pump | 4 | Checking Gas Input | 13-14 |
| INSTALLATION INSTRUCTIONS | 4-9 | Vent System | 14 |
| Required Ability | 4 | Relief Valve | 14 |
| Locating The Heater | 4-5 | Hot Water Odor | 14 |
| High Altitude Installations | 5 | Anode Rod Inspection | 14 |
| Clearances | 5 | Winter Protection | 14 |
| Hard Water | 5 | Replacement Parts | 14 |
| Air Requirements | 5-6 | PREVENTIVE MAINTENANCE | 15-16 |
| Water (Potable) Heating and Space Heating | 6 | Recommended Procedure For Periodic Removal Of Lime | |
| Venting | 6-7 | Deposits From Tank Type Commercial Water Heaters | 15 |
| Thermometers (Not Supplied) | 7 | Deliming Solvents | 15-16 |
| Relief Valve | 7 | Tank Cleanout Procedure | 15-16 |
| Gas Piping | 8-9 | CHECKLIST | 16-17 |
| Gas Pressure Regulator | 9 | LIMITED WARRANTY | 18 |

GENERAL SAFETY INFORMATION

PRECAUTIONS

DO NOT USE THIS APPLIANCE IF ANY PART HAS BEEN UNDER WATER. Immediately call a qualified service technician to inspect the appliance and to replace any part of the control system and any gas control which has been under water.

IF THE UNIT IS EXPOSED TO THE FOLLOWING, DO NOT OPERATE HEATER UNTIL ALL CORRECTIVE STEPS HAVE BEEN MADE BY A QUALIFIED SERVICEMAN.

1. EXTERNAL FIRE.
2. DAMAGE.
3. FIRING WITHOUT WATER.
4. SOOTING

CHEMICAL VAPOR CORROSION



WARNING

CORROSION OF THE FLUEWAYS AND VENT SYSTEM MAY OCCUR IF AIR FOR COMBUSTION CONTAINS CERTAIN CHEMICAL VAPORS. SUCH CORROSION MAY RESULT IN FAILURE AND RISK OF ASPHYXIATION.

Spray can propellants, cleaning solvents, refrigerator and air conditioning refrigerants, swimming pool chemicals, calcium and sodium chloride (water softener salt), waxes, and process chemicals are typical compounds which are potentially corrosive. Do not store products of this sort near the heater. Also, air which is brought in contact with the heater should not contain any of these chemicals. If necessary, uncontaminated air should be obtained from remote or outside sources. The limited warranty is voided when failure of water heater is due to a corrosive atmosphere. (Refer to the limited warranty for complete terms and conditions.)

IMPROPER COMBUSTION



WARNING

ATTIC AND/OR EXHAUST FANS OPERATING ON THE PREMISES WITH A WATER HEATER CAN RESULT IN CARBON MONOXIDE POISONING AND DEATH.

OPERATION OF THESE FANS CAN PRODUCE A NEGATIVE DRAFT IN THE AREA OF THE WATER HEATER PREVENTING THE PRODUCTS OF COMBUSTION FROM EXHAUSTING THROUGH THE CHIMNEY OR VENT PIPE.

The venting of the water heater should be inspected by a qualified service technician at the time of installation and periodically thereafter to ensure a down-draft condition does not exist.

DO NOT OBSTRUCT THE FLOW OF COMBUSTION AND VENTILATING AIR. ADEQUATE AIR FOR COMBUSTION AND VENTILATION MUST BE PROVIDED FOR SAFE OPERATION.

LIQUID PETROLEUM MODELS

Water heaters for propane or liquefied petroleum gas (LPG) are different from natural gas models. A natural gas heater will not function safely on LP gas and no attempt should be made to convert a heater from natural gas to LP gas.

LP gas must be used with great caution. It is highly explosive and heavier than air. It collects first in the low areas making its odor difficult to detect at nose level. If LP gas is present or even suspected, do not attempt to find the cause yourself. Go to a neighbor's house, leaving your doors open to ventilate the house, then call your gas supplier or service agent. Keep area clear until a service call has been made.

At times you may not be able to smell an LP gas leak. One cause is odor fade, which is a loss of the chemical odorant that gives LP gas its distinctive smell. Another cause can be your physical condition, such as having a cold or diminishing sense of smell with age. For these reasons, the use of a propane gas detector is recommended.

IF YOU EXPERIENCE AN OUT-OF-GAS SITUATION, DO NOT TRY TO RELIGHT APPLIANCES YOURSELF, ask your LP delivery person to relight pilots for you. Only trained LP professionals should conduct the required safety checks in accordance with industry standards.

EXTENDED NON-USE PERIODS

WARNING

HYDROGEN GAS CAN BE PRODUCED IN A HOT WATER SYSTEM SERVED BY THIS HEATER THAT HAS NOT BEEN USED FOR A LONG PERIOD OF TIME (GENERALLY TWO WEEKS OR MORE). HYDROGEN GAS IS EXTREMELY FLAMMABLE. To reduce the risk of injury under these conditions, it is recommended that the hot water faucet be opened for several minutes at the kitchen sink before using any electrical appliance connected to the hot water system. If hydrogen is present, there will probably be an unusual sound such as air escaping through the pipe as the water begins to flow. **THERE SHOULD BE NO SMOKING OR OPEN FLAME NEAR THE FAUCET AT THE TIME IT IS OPEN.**

INSULATION BLANKETS

Insulation blankets available to the general public for external use on gas water heaters are not approved for use on your A.O. Smith water heater. The purpose of an insulation blanket is to reduce the standby heat loss encountered with storage tank water heaters. Your A.O. Smith water heater meets or exceeds the ASHRAE/IES 90.1b-1999 standards with respect to insulation and standby loss requirement making an insulation blanket unnecessary.

WARNING

Should you choose to apply an insulation blanket to this heater, you should follow these instructions. Failure to follow these instructions can result in fire, asphyxiation, serious personal injury or death.

- **Do not apply insulation to the top of the water heater, as this will interfere with safe operation of the draft hood.**
- **Do not cover the outer door, thermostat or temperature & pressure relief valve.**
- **Do not allow insulation to come within 2" (5cm) of the floor to prevent blockage of combustion air flow to the burner.**
- **Do not cover the instruction manual. Keep it on the side of the water heater or nearby for future reference.**
- **Do obtain new warning and instruction labels from A.O. Smith for placement on the blanket directly over the existing labels.**
- **Do inspect the insulation blanket frequently to make certain it does not sag, thereby obstructing combustion air flow.**

CIRCULATING PUMP

A circulating pump is used when a system requires a circulating loop or there is a storage tank used in conjunction with the heater. Install the system in accordance with the current edition of the National Electrical Code ANSI/NFPA No. 70 or the Canadian Electrical Code CSA C22.1.

Only all bronze circulators are used with commercial water heaters. Although circulators are oiled and operated by the manufacturer some circulators must be oiled again before operating. Please refer to manufacturer's instructions.

INSTALLATION INSTRUCTIONS

REQUIRED ABILITY

INSTALLATION OR SERVICE OF THIS WATER HEATER REQUIRES ABILITY EQUIVALENT TO THAT OF A LICENSED TRADESMAN IN THE FIELD INVOLVED. PLUMBING, AIR SUPPLY, VENTING AND GAS SUPPLY WORK ARE REQUIRED.

GENERAL

The heater is designed to operate on natural or propane gases. **HOWEVER, MAKE SURE** the gas on which the heater will operate is the same as that specified on the heater model and rating plate.

LOCATING THE HEATER

When installing the heater, consideration must be given to proper location. Location selected should be as close to the stack or chimney as practicable, with adequate air supply and as centralized with the piping system as possible.

WARNING

THERE IS A RISK IN USING FUEL BURNING APPLIANCES SUCH AS GAS WATER HEATERS IN ROOMS, GARAGES OR OTHER AREAS WHERE GASOLINE, OTHER FLAMMABLE LIQUIDS OR ENGINE DRIVEN EQUIPMENT OR VEHICLES ARE STORED, OPERATED OR REPAIRED. FLAMMABLE VAPORS ARE HEAVY AND TRAVEL ALONG THE FLOOR AND MAY BE IGNITED BY THE HEATER'S PILOT OR MAIN BURNER FLAMES CAUSING FIRE OR EXPLOSION. SOME LOCAL CODES PERMIT OPERATION OF GAS APPLIANCES IF INSTALLED 18" (46CM) OR MORE ABOVE THE FLOOR. THIS MAY REDUCE THE RISK IF LOCATION IN SUCH AN AREA CANNOT BE AVOIDED.

DO NOT INSTALL THIS WATER HEATER DIRECTLY ON A CARPETED FLOOR. A FIRE HAZARD MAY RESULT. Instead the water heater must be placed on a metal or wood panel extending beyond the full width and depth by at least 3" (76.2mm) in any direction. If the heater is installed in a carpeted alcove or closet, the entire floor shall be covered by the panel. Also, see the drain requirements.

THIS HEATER SHALL BE LOCATED OR PROTECTED SO IT IS NOT SUBJECT TO PHYSICAL DAMAGE BY A MOVING VEHICLE.

WARNING

FLAMMABLE ITEMS, PRESSURIZED CONTAINERS OR ANY OTHER POTENTIAL FIRE HAZARDOUS ARTICLES MUST NEVER BE PLACED ON OR ADJACENT TO THE HEATER. OPEN CONTAINERS OF FLAMMABLE MATERIAL SHOULD NOT BE STORED OR USED IN THE SAME ROOM WITH THE HEATER.

THE HEATER MUST NOT BE LOCATED IN AN AREA WHERE IT WILL BE SUBJECT TO FREEZING.

THE HEATER SHOULD BE LOCATED IN AN AREA WHERE LEAKAGE FROM THE HEATER OR CONNECTIONS WILL NOT RESULT IN DAMAGE TO THE ADJACENT AREA OR TO LOWER FLOORS OF THE STRUCTURE.

WHEN SUCH LOCATIONS CANNOT BE AVOIDED, A SUITABLE DRAIN PAN SHOULD BE INSTALLED UNDER THE HEATER. Such pans should be fabricated with sides at least 2" (5cm) deep, with length and width at least 2" (5cm) greater than the diameter of the heater and must be piped to an adequate drain. The pan must not restrict combustion air flow.

Drain pans suitable for these heaters are available from your distributor or A. O. Smith Water Products Company, 500 Tennessee Waltz Parkway, Ashland City, TN 37015.

Water heater life depends upon water quality, water pressure and the environment in which the water heater is installed. Water heaters are sometimes installed in locations where leakage may result in property damage, even with the use of a drain pan piped to a drain. However, unanticipated damage can be reduced or prevented by a leak detector or water shutoff device used in conjunction with a piped drain pan. These devices are available from some plumbing supply wholesalers and retailers, and detect and react to leakage in various ways:

- Sensors mounted in the drain pan that trigger an alarm or turn off the incoming water to the water heater when leakage is detected.
- Sensors mounted in the drain pan that turn off the water supply to the entire home when water is detected in the drain pan.
- Water supply shutoff devices that activate based on the water pressure differential between the cold water and hot water pipes connected to the water heater.
- Devices that will turn off the gas supply to a gas water heater while at the same time shutting off its water supply.

For appliance installation locations with elevations above 2000' (610m), refer to HIGH ALTITUDE INSTALLATIONS section of this manual for input reduction procedure.

HIGH ALTITUDE INSTALLATIONS



WARNING

INSTALLATIONS ABOVE 2000' (610m) REQUIRE REPLACEMENT OF THE BURNER ORIFICE IN ACCORDANCE WITH SECTION 8.1.2 OF THE NATIONAL FUEL GAS CODE (ANSI Z223.1). FOR CANADIAN INSTALLATIONS CONSULT THE NATURAL GAS AND PROPANE INSTALLATION CODE CAN/CSA-B149.1. FAILURE TO REPLACE THE ORIFICE WILL RESULT IN IMPROPER AND INEFFICIENT OPERATION OF THE APPLIANCE RESULTING IN THE PRODUCTION OF INCREASED LEVELS OF CARBON MONOXIDE GAS IN EXCESS OF SAFE LIMITS WHICH COULD RESULT IN SERIOUS PERSONAL INJURY OR DEATH.

You should contact your gas supplier for any specific changes which may be required in your area.

As elevation above sea level is increased, there is less oxygen per cubic foot of air. Therefore, the heater input rate should be reduced at high altitudes for satisfactory operation with the reduced oxygen supply. Failure to make this reduction would result in an overfiring of the heater causing sooting, poor combustion and/or unsatisfactory heater performance.

U.S. REQUIREMENTS

Ratings specified by manufacturers for most appliances apply for elevations up to 2000 feet (610m). For elevations above 2000 feet (610m), ratings must be reduced at the rate of 4% for each 1000 feet (305m) above sea level. For example, if a heater is rated at 75,100 Btu/Hr (22.0 kW) at sea level, to rate the heater at 4000 feet (1219m), you subtract 4 (once for each thousand feet) x 0.04 (4% input reduction) x 75,100 Btu/Hr (original rating) from the original rating. Therefore, to calculate the input rating at 4000 feet (1219m): $4 \times 0.04 \times 75,100 \text{ Btu/Hr} = 12,016 \text{ Btu/Hr}$ (3.5 kW); $75,100 \text{ Btu/Hr}$ (22.0 kW) - $12,016 \text{ Btu/Hr}$ (3.5 kW) = $63,084 \text{ Btu/Hr}$ (18.5 kW). At 6000 feet (1829m) the correct input rating should be 57,076 Btu/Hr (16.7 kW).

CANADIAN REQUIREMENTS

Appliances with inputs up to and including 400,000 BTU (117.1 kwh) must be factory equipped with orifices for operation at specific elevations. Standard (sea level) orifices permit operation up to 2000' (610m) elevation. For operation between 2000' (610m) and 4500' (1370m) specify "HIGH ALTITUDE OPERATION" when ordering the heater(s). For operation above 4500' (1370m) consult factory before ordering. Field conversion for operation at altitudes other than that

specified on the heater rating plate is not permitted.

The input reduction is primarily achieved by reducing the size of the main burner orifices. To do this, the main burner orifices require replacement with orifices sized for the particular installation elevation. Correct orifice sizing and parts may be obtained from A.O. Smith Water Products Company. When ordering, be sure to state the model number and the altitude of the location where the water heater is being installed.

Upon completion of derating of the heater, adjustment to the gas pressure regulator may be required. See CHECKING THE INPUT section in this manual for inlet and manifold pressure requirements.

Also due to the input rating reduction required at high altitudes, the recovery rating of the appliance is also reduced and should be compensated for in the sizing of the equipment for application.

CLEARANCES

These heaters are approved for installation on combustible flooring in a closet having a ceiling 12" (30.5cm) above top cover and with clearances to combustible construction of 6" (15.2cm) from flue or vent connector, 0" (0cm) at the sides and rear and 4" (10.1cm) to front to prevent a possible fire hazard condition. A minimum of 4" (10.1cm) shall be allowed for installation of serviceable parts.

HARD WATER

Where hard water conditions exist, water softening or the threshold type of water treatment is recommended. This will protect the dishwashers, coffee urns, water heaters, water piping and other equipment.

See PREVENTIVE MAINTENANCE section for details of tank cleanout procedure.

AIR REQUIREMENTS

REFER TO THE CURRENT EDITION OF THE NATIONAL FUEL GAS CODE ANSI Z223.1/NFPA 54.

KEEP APPLIANCE AREA CLEAR AND FREE OF COMBUSTIBLE MATERIALS, GASOLINE AND OTHER FLAMMABLES, VAPORS AND LIQUIDS.

DO NOT OBSTRUCT THE FLOW OF COMBUSTION OR VENTILATING AIR.



WARNING

FOR SAFE OPERATION PROVIDE ADEQUATE AIR FOR COMBUSTION AND VENTILATION. AN INSUFFICIENT SUPPLY OF AIR WILL CAUSE RECIRCULATION OF COMBUSTION PRODUCTS RESULTING IN AIR CONTAMINATION THAT MAY BE HAZARDOUS TO LIFE. SUCH A CONDITION OFTEN WILL RESULT IN A YELLOW, LUMINOUS BURNER FLAME, CAUSING CARBONING OR SOOTING OF THE COMBUSTION CHAMBER, BURNERS AND FLUE TUBES AND CREATES A RISK OF ASPHYXIATION.

Where an exhaust fan is supplied in the same room with a heater, sufficient openings for air must be provided in the walls. **UNDERSIZED OPENINGS WILL CAUSE AIR TO BE DRAWN INTO THE ROOM THROUGH THE CHIMNEY, CAUSING POOR COMBUSTION. SOOTING MAY RESULT IN SERIOUS DAMAGE TO THE HEATER AND RISK OF FIRE OR EXPLOSION.**

UNCONFINED SPACE

In buildings of conventional frame, brick, or stone construction, unconfined spaces may provide adequate air for combustion, ventilation and draft hood dilution.

If the unconfined space is within a building of tight construction (buildings using the following construction: weather stripping, heavy

insulation, caulking, vapor barrier, etc.), air for combustion, ventilation and draft hood dilution must be obtained from outdoors. The installation instructions for confined spaces in tightly constructed buildings must be followed to ensure adequate air supply.

CONFINED SPACE

When drawing combustion and dilution air from inside a conventionally constructed building to a confined space, such a space shall be provided with two permanent openings, ONE IN OR WITHIN 12" (305mm) OF THE ENCLOSURE TOP AND ONE IN OR WITHIN 12" (305mm) OF THE ENCLOSURE BOTTOM. Each opening shall have a free area of at least one square inch per 1000 Btu/Hr (2203mm²/kW) of the total input of all appliances in the enclosure, but not less than 100 square inches (645cm²).

If the confined space is within a building of tight construction, air for combustion, ventilation, and draft hood dilution must be obtained from outdoors. When directly communicating with the outdoors or communicating with the outdoors through vertical ducts, two permanent openings, located in the above manner, shall be provided. Each opening shall have a free area of not less than one square inch per 4000 Btu/Hr (551mm²/kW) of the total input of all appliances in the enclosure. If horizontal ducts are used, each opening shall have a free area of not less than one square inch per 2000 Btu/Hr (1102mm²/kW) of the total input of all appliances in the enclosure.

WATER (POTABLE) HEATING AND SPACE HEATING

1. All piping components connected to this unit for space heating applications shall be suitable for use with potable water.
2. Toxic chemicals, such as those used for boiler treatment, shall NEVER be introduced into this system.
3. This unit may NEVER be connected to any existing heating system or component(s) previously used with a non-potable water heating appliance.
4. When the system requires water for space heating at temperatures higher than required for domestic water purposes, a tempering valve must be installed, see Figure 4.

⚠ CAUTION

A closed system will exist if a check valve (without bypass), pressure reducing valve (without bypass), or a water meter (without bypass) is installed in the cold water line between the water heater and street main (or well).

Excessive pressure may develop in such closed systems, causing premature tank failure or intermittent relief valve operation. **This is not a warranty failure.** An expansion tank or a similar device is required in the inlet supply line between the appliance and the meter or valve to compensate for the thermal expansion of the water.

SYSTEM CONNECTIONS

The system installation must conform to these instructions and to the local code authority having jurisdiction. Good practice requires that all heavy piping be supported.

VENTING

⚠ WARNING

THE INSTRUCTIONS IN THIS SECTION ON VENTING MUST BE FOLLOWED TO AVOID CHOKED COMBUSTION OR RECIRCULATION OF FLUE GASES. SUCH CONDITIONS CAUSE SOOTING OR RISKS OF FIRE AND ASPHYXIATION.

Heater must be protected from freezing downdrafts.

Remove all soot or other obstructions from the chimney that will retard a free draft.

Type B venting is recommended with these heaters.

This water heater must be vented in compliance with all local codes, the current edition of the National Fuel Gas Code ANSI-Z223.1 or the Natural Gas and Propane Installation Code CAN/CSA-B149.1.

If any part of the vent system is exposed to ambient temperatures below 35° F (2° C) it must be insulated to prevent condensation.

- Do not connect the heater to a common vent or chimney with any oil-fired or solid fuel burning equipment. This practice is prohibited by many local building codes as is the practice of venting gas fired equipment to the duct work of ventilation systems.

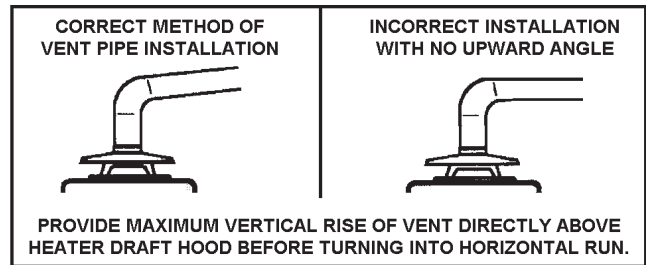

FIGURE 2.

DRAFT HOOD

The draft hood furnished with this heater must be installed without alteration. Provision must be made if it is installed in confined space or a small room to accommodate draft hood spillage and avoid risks described in previous steps. The upper air opening called for in the AIR REQUIREMENTS section of this manual is for this purpose.

Locate the 3 brackets and 6 screws in the installation instruction bag. Secure each bracket to the draft hood leg with the screws furnished. Place the draft hood on the water heater so that legs of the draft hood fit into the slots on the jacket top, see Figure 3. Once the draft hood (with brackets attached) is in place, drill a small pilot hole through bracket hole into the jacket top. **WARNING, DO NOT PENETRATE THE JACKET TOP BY MORE THAN 1/4".** Secure the brackets to the jacket top with the screws furnished, see Figure 3.

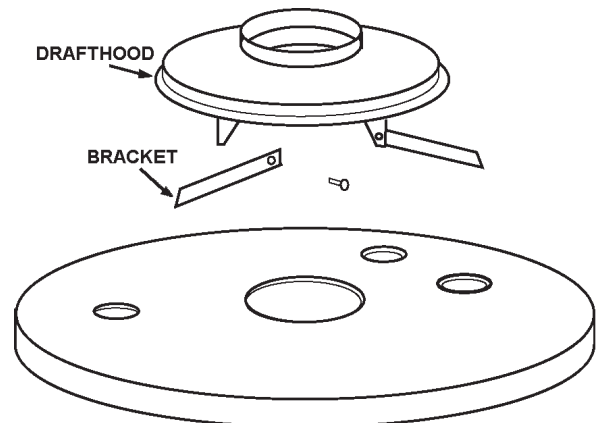

FIGURE 3.

VENT CONNECTION

Vent connections must be made to an adequate stack or chimney. Size and install proper size vent pipe. Do not reduce pipe size to less than that of the draft hood outlet.

Horizontal runs of vent pipe must have a minimum upward slope toward the chimney of 1/4 inch per foot. Dampers or other obstructions must not be installed in between the heater and the draft hood. Be sure that the vent pipe does not extend beyond the inside wall of the chimney.

Where a continuous or intermittent back draft is found to exist, the cause must be determined and corrected. A special vent cap may be required. If the back draft cannot be corrected by the normal methods or if a suitable draft cannot be obtained, a blower type flue gas exhauster must be employed to assure proper venting and correct combustion.

THERMOMETERS (Not Supplied)

Thermometers should be obtained and field installed as shown, see Figure 4.

Thermometers are installed in the system as a means of detecting the temperature of the outlet water supply.

RELIEF VALVE

This water heater is equipped with a combination temperature-pressure relief valve that complies with the standard for relief valves for hot water supply system, ANSI Z21.22/CSA 4.4. **FOR SAFE OPERATION OF THE WATER HEATER, THE RELIEF VALVE(S) MUST NOT BE REMOVED OR PLUGGED.**

ASME ratings cover pressure relief capacities. ANSI ratings cover release rate with temperature actuation.

In addition to the appliance relief valve, each remote storage tank which may be used in conjunction with this appliance shall also be

installed with a properly sized, rated and approved combination temperature (ANSI) and pressure (ASME) relief valve(s).



WARNING

THE PURPOSE OF RELIEF VALVE IS TO AVOID EXCESSIVE PRESSURE OR TEMPERATURE INTO THE STEAM RANGE, WHICH MAY CAUSE SCALDING AT FIXTURES, TANK EXPLOSION, SYSTEM OR HEATER DAMAGE. NO VALVE IS TO BE PLACED BETWEEN THE RELIEF VALVE AND TANK.

Your local code authority may have other specific relief valve requirements.

A DRAIN LINE MUST BE CONNECTED TO THE RELIEF VALVE TO DIRECT DISCHARGE TO A SAFE LOCATION TO AVOID SCALDING OR WATER DAMAGE. THIS LINE MUST NOT BE REDUCED FROM THE SIZE OF THE VALVE OUTLET AND MUST NOT CONTAIN VALVES, RESTRICTIONS NOR SHOULD IT BE LOCATED IN FREEZING AREAS. DO NOT THREAD OR CAP THE END OF THIS LINE. RESTRICTED OR BLOCKED DISCHARGE WILL DEFEAT THE PURPOSE OF THE VALVE AND IS UNSAFE. DISCHARGE LINE SHALL BE INSTALLED TO ALLOW COMPLETE DRAINAGE OF BOTH THE VALVE AND LINE.

See **SERVICE INFORMATION** section for procedure and precautions.

The type, size and location of the relief valves must be in accordance with local codes. The locations of the relief valves shown in the installation diagrams are typical. The heater has a factory installed high temperature limit switch.

For circulating heaters, the separate storage vessel must have a temperature and pressure relief valve installed. This valve shall comply with the standard for relief valves and automatic gas shut-off devices for hot water supply systems.

Cold water inlet lines to heater should be installed as shown in order to minimize gravity circulation of hot water to building cold water lines.

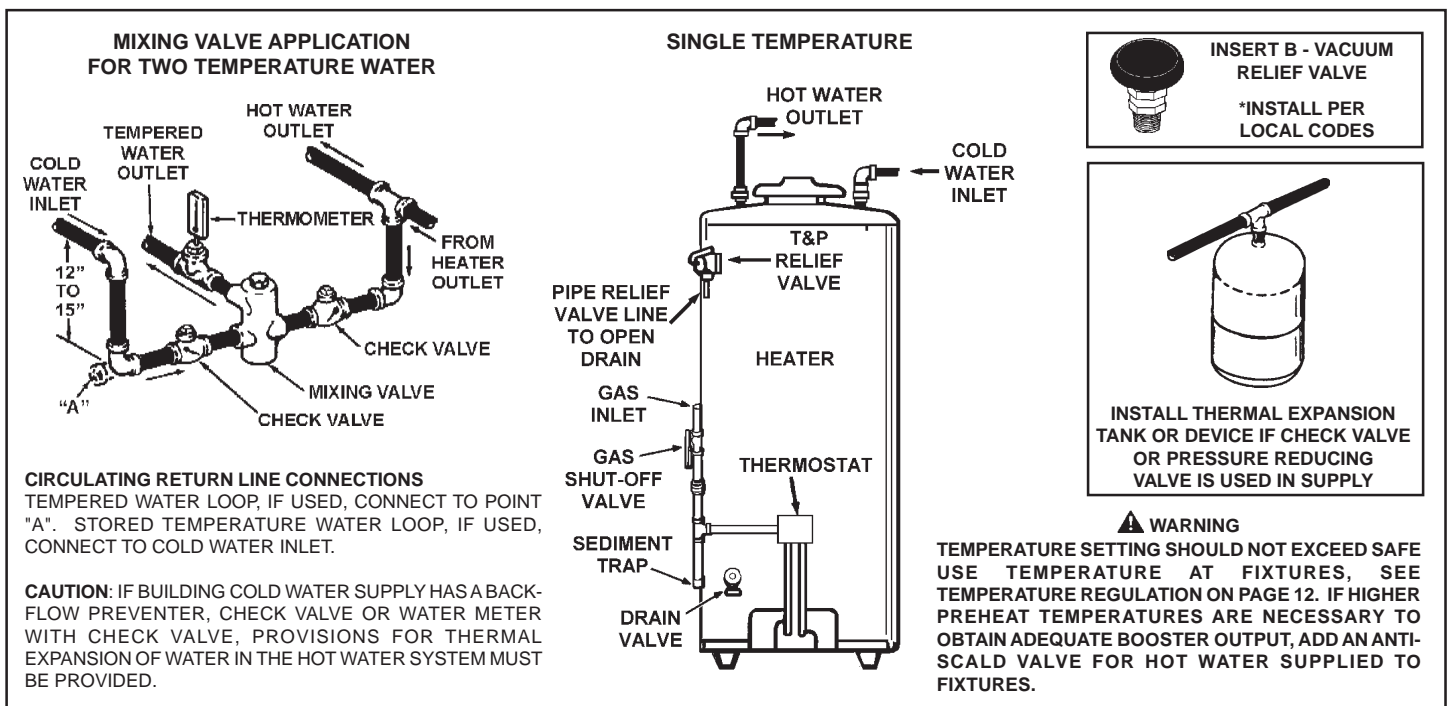

FIGURE 4

GAS PIPING

Contact your local gas service company to ensure that adequate gas service is available and to review applicable installation codes for your area.

Size the main gas line in accordance with Table 1. The figures shown are for straight lengths of pipe at 0.5 in. W.C. pressure drop, which is considered normal for low pressure systems. Note: Fittings such as elbows, tees and line regulators will add to the pipe pressure drop. Also refer to the current editions of the National Fuel Gas Code or Natural Gas and Propane Installation Code.

! WARNING

THE HEATER IS NOT INTENDED FOR OPERATION AT HIGHER THAN 14.0" W.C.(3.48 kPa) - NATURAL GAS OR 14.0" W.C. (3.48 kPa) PROPANE GAS SUPPLY PRESSURE. EXPOSURE TO HIGHER SUPPLY PRESSURE MAY CAUSE DAMAGE TO THE GAS VALVE WHICH COULD RESULT IN FIRE OR EXPLOSION. IF OVERPRESSURE HAS OCCURRED SUCH AS THROUGH IMPROPER TESTING OF GAS LINES OR EMERGENCY MALFUNCTION OF THE SUPPLY SYSTEM, THE GAS VALVE MUST BE CHECKED FOR SAFE OPERATION. MAKE SURE THAT THE OUTSIDE VENTS ON THE SUPPLY REGULATORS AND THE SAFETY VENT VALVES ARE PROTECTED AGAINST BLOCKAGE. THESE ARE PARTS OF THE GAS SUPPLY SYSTEM, NOT THE HEATER. VENT BLOCKAGE MAY OCCUR DURING ICE STORMS.

**TABLE 1 - GAS SUPPLY LINE SIZES (IN INCHES)*
MAXIMUM CAPACITY OF PIPE IN
CUBIC FEET PER HOUR**

| LENGTH IN FEET | NOMINAL IRON PIPE SIZES (INCHES) INPUT IN THOUSANDS (BTU/HR) | | | | | | | | |
|------------------------|---|------|-----|--------|--------|------|--------|-------|-------|
| | 1/2" | 3/4" | 1" | 1 1/4" | 1 1/2" | 2" | 2 1/2" | 3" | 4" |
| 10 | 175 | 360 | 680 | 1400 | 2100 | 3960 | 6300 | 11000 | 23000 |
| 20 | 120 | 250 | 465 | 950 | 1460 | 2750 | 4360 | 7700 | 15800 |
| 30 | 97 | 200 | 375 | 770 | 1180 | 2200 | 3520 | 6250 | 12800 |
| 40 | 82 | 170 | 320 | 660 | 990 | 1900 | 3000 | 5300 | 10900 |
| 50 | 73 | 151 | 285 | 580 | 900 | 1680 | 2650 | 4750 | 9700 |
| 60 | 66 | 138 | 260 | 530 | 810 | 1520 | 2400 | 4300 | 8800 |
| 70 | 61 | 125 | 240 | 490 | 750 | 1400 | 2250 | 3900 | 8100 |
| 80 | 57 | 118 | 220 | 460 | 690 | 1300 | 2050 | 3700 | 7500 |
| 90 | 53 | 110 | 205 | 430 | 650 | 1220 | 1950 | 3450 | 7200 |
| 100 | 50 | 103 | 195 | 400 | 620 | 1150 | 1850 | 3250 | 6700 |
| 125 | 44 | 93 | 175 | 360 | 550 | 1020 | 1650 | 2950 | 6000 |
| 150 | 40 | 84 | 160 | 325 | 500 | 950 | 1500 | 2650 | 5500 |
| 175 | 37 | 77 | 145 | 300 | 460 | 850 | 1370 | 2450 | 5000 |
| 200 | 35 | 72 | 135 | 280 | 430 | 800 | 1280 | 2280 | 4600 |
| LENGTH IN METERS | NOMINAL IRON PIPE SIZES (INCHES) INPUT IN KW | | | | | | | | |
| | 1/2" | 3/4" | 1" | 1 1/4" | 1 1/2" | 2" | 2 1/2" | 3" | 4" |
| 3 | 51 | 105 | 199 | 410 | 615 | 1160 | 1845 | 3221 | 6735 |
| 6 | 35 | 73 | 142 | 278 | 428 | 805 | 1277 | 2255 | 4626 |
| 9 | 28 | 59 | 110 | 225 | 346 | 644 | 1031 | 1830 | 3748 |
| 12 | 24 | 50 | 94 | 193 | 290 | 556 | 878 | 1552 | 3192 |
| 15 | 21 | 44 | 83 | 170 | 264 | 492 | 776 | 1391 | 2840 |
| 18 | 19 | 40 | 76 | 155 | 237 | 445 | 703 | 1259 | 2577 |
| 21 | 18 | 37 | 70 | 143 | 220 | 410 | 659 | 1142 | 2372 |
| 24 | 17 | 35 | 64 | 135 | 202 | 381 | 600 | 1083 | 2196 |
| 27 | 16 | 32 | 60 | 126 | 190 | 357 | 571 | 1010 | 2108 |
| 31 | 15 | 30 | 57 | 117 | 182 | 337 | 542 | 952 | 1962 |
| 38 | 13 | 27 | 51 | 105 | 161 | 299 | 483 | 864 | 1757 |
| 46 | 12 | 25 | 47 | 95 | 146 | 278 | 439 | 776 | 1610 |
| 53 | 11 | 23 | 42 | 88 | 135 | 249 | 401 | 717 | 1464 |
| 61 | 10 | 21 | 40 | 82 | 126 | 234 | 375 | 688 | 1347 |

IT IS IMPORTANT TO GUARD AGAINST GAS VALVE FOULING FROM CONTAMINANTS IN THE GAS WAYS. SUCH FOULING MAY CAUSE IMPROPER OPERATION, FIRE OR EXPLOSION.

IF COPPER SUPPLY LINES ARE USED THEY MUST BE INTERNALLY TINNED AND CERTIFIED FOR GAS SERVICE. BEFORE ATTACHING THE GAS LINE, BE SURE THAT ALL GAS PIPE IS CLEAN ON THE INSIDE.

TO TRAP ANY DIRT OR FOREIGN MATERIAL IN THE GAS SUPPLY LINE, A DIRT LEG (SOMETIMES CALLED SEDIMENT TRAP OR DRIP LEG) MUST BE INCORPORATED IN THE PIPING (SEE FIG. 5). THE DIRT LEG MUST BE READILY ACCESSIBLE AND NOT SUBJECT TO FREEZING CONDITIONS. INSTALL IN ACCORDANCE WITH RECOMMENDATIONS OF SERVING GAS SUPPLIERS. REFER TO THE CURRENT EDITION OF THE NATIONAL FUEL GAS CODE OR NATURAL GAS AND PROPANE INSTALLATION CODE.

To prevent damage, care must be taken not to apply too much torque when attaching gas supply pipe to gas valve inlet.

Apply joint compounds (pipe dope) sparingly and only to the male threads of pipe joints. Do not apply compounds to the first two threads. Use compounds resistant to the action of liquefied petroleum gases.

BEFORE PLACING THE HEATER IN OPERATION, CHECK FOR GAS LEAKAGE. Use soap and water solution or other material acceptable for the purpose in locating the leaks. **DO NOT USE MATCHES, CANDLES, FLAME OR OTHER SOURCES OF IGNITION FOR THIS PURPOSE.**

DISCONNECT THE HEATER AND ITS MANUAL GAS SHUTOFF VALVE FROM THE GAS SUPPLY PIPING SYSTEM DURING ANY SUPPLY PRESSURE TESTING EXCEEDING 1/2 PSIG (3.45 kPa). GAS SUPPLY LINE MUST BE CAPPED WHEN DISCONNECTED FROM THE HEATER FOR TEST PRESSURES OF 1/2 PSIG (3.45 kPa) OR LESS. THE APPLIANCE NEED NOT BE DISCONNECTED, BUT MUST BE ISOLATED FROM THE SUPPLY PRESSURE TEST BY CLOSING THE MANUAL GAS SHUTOFF VALVE.

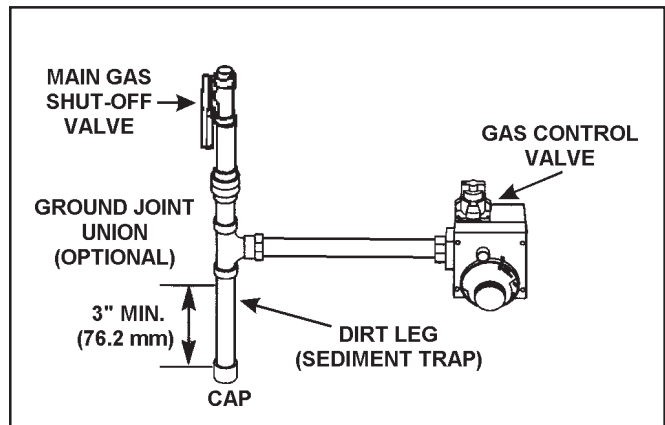

FIGURE 5 - GAS PIPING AND DIRT LEG INSTALLATION

GAS METER SIZE

Be sure the gas meter has sufficient capacity to supply the full rated gas input of the water heater as well as the requirements of all other gas fired equipment supplied by the meter. If gas meter is too small, ask the gas company to install a larger meter having adequate capacity.

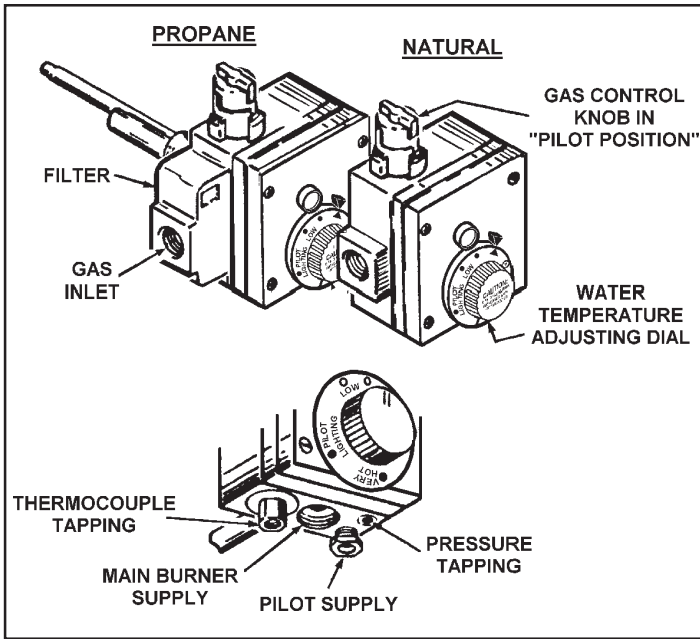

FIGURE 6-THERMOSTAT FOR NATURAL AND PROPANE GASES

GAS PRESSURE REGULATOR

The gas pressure regulator is built into the gas valve and is equipped to operate on the gas specified on model and rating plate. The regulator is factory adjusted to deliver gas to burner at correct water column pressure allowing for a nominal pressure drop through the controls.

The minimum gas supply pressure for input adjustment must not be less than 5.0" W.C. (1.24 kPa) for natural gas and 11.0" W.C. (2.74 kPa) for propane gas.

Do not subject the combination gas valve to inlet gas pressures of more than 14.0" w.c. (3.48 kPa). A service regulator is necessary if higher gas pressures are encountered.

Gas pressure specified in Table 2, refer to flow pressure taken at pressure tap of automatic gas valve while heater is operating.

OPERATION

It is recommended that a qualified person perform the initial firing of the heater. At this time the user should not hesitate to ask the

individual any questions which he may have in regard to the operation and maintenance of the unit.

! WARNING

DO NOT ATTEMPT TO OPERATE WATER HEATER WITH COLD WATER INLET VALVE CLOSED.

NEVER OPERATE THE HEATER WITHOUT FIRST BEING CERTAIN IT IS FILLED WITH WATER AND A TEMPERATURE AND PRESSURE RELIEF VALVE IS INSTALLED IN THE RELIEF VALVE OPENING OF THE HEATER. DO NOT ATTEMPT TO OPERATE HEATER WITH COLD WATER INLET VALVE CLOSED.

TO OPERATE THE WATER HEATER

1. Close the heater drain valve by turning handle clockwise ↻.
2. Open a nearby hot water faucet to permit the air in the system to escape.
3. Fully open the cold water inlet pipe valve allowing the heater and piping to be filled.
4. Close the hot water faucet as water starts to flow.
5. The heater is ready to be operated.

A checklist is included in the SERVICE INFORMATION section of this manual. By using this checklist the user may be able to make minor operational adjustments and save himself unnecessary service calls. However, the user should not attempt repairs which are not listed in this section.

PURGING

Gas line purging is required with new piping or systems in which air has entered.

! CAUTION

PURGING SHOULD BE PERFORMED BY PERSONS EXPERIENCED IN THIS TYPE GAS SERVICE. TO AVOID RISK OF FIRE OR EXPLOSION, PURGE DISCHARGE MUST NOT ENTER CONFINED AREAS OR SPACES WHERE IGNITION CAN OCCUR. THE AREA MUST BE WELL VENTILATED AND ALL SOURCES OF IGNITION MUST BE INACTIVATED OR REMOVED.

**TABLE 2.
MANIFOLD PRESSURE SETTING**

| Model Number | Type of Gas | Input | | Manifold Pressure | |
|--------------|-------------|---------------|-------|-------------------|---------|
| | | Btu/Hr | kW | in. W.C. | kPa |
| BT-80 | Natural | 75,100 Btu/Hr | 22 kW | 4.0 in. W.C. | 1.0 kPa |
| BT-80 | Propane | 75,100 Btu/Hr | 22 kW | 10.0 in. W.C. | 2.5 kPa |
| BT-100 | Natural | 75,100 Btu/Hr | 22 kW | 4.0 in. W.C. | 1.0 kPa |
| BT-100 | Propane | 75,100 Btu/Hr | 22 kW | 10.0 in. W.C. | 2.5 kPa |

FOR YOUR SAFETY READ BEFORE LIGHTING



WARNING: If you do not follow these instructions exactly, a fire or explosion may result causing property damage, personal injury or loss of life.



BEFORE LIGHTING: ENTIRE SYSTEM MUST BE FILLED WITH WATER AND AIR PURGED FROM ALL FAUCETS.

- A. This appliance has a pilot which is lit by a piezo electric spark gas ignition system. When lighting the pilot, follow these instructions exactly.
- B. **BEFORE LIGHTING** smell all around the appliance area for gas. Be sure to smell next to the floor because some gas is heavier than air and will settle on the floor.
- WHAT TO DO IF YOU SMELL GAS:**
- Do not try to light any appliance.
 - Do not touch any electric switch; do not use any phone in your building.
 - Immediately call your gas supplier from a neighbor's phone. Follow the gas supplier's instructions.
- If you cannot reach your gas supplier, call the fire department.
- C. Use only your hand to push down or turn the gas control knob. Never use tools. If the knob will not push down or turn by hand, don't try to repair it, call a qualified service technician. Force or attempted repair may result in a fire or explosion.
- D. Do not use this appliance if any part has been under water. Immediately contact a qualified installer or service agency to replace a flooded water heater. Do not attempt to repair the unit! It must be replaced!

LIGHTING INSTRUCTIONS

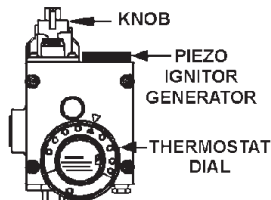

GAS CONTROL

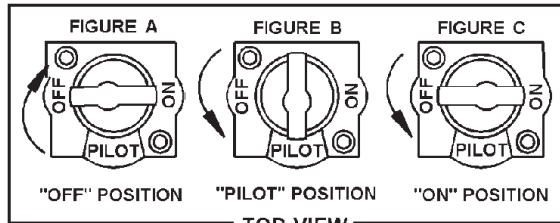

TOP VIEW

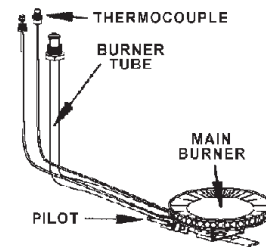

FIGURE "D"

1. **STOP!** Read the safety information above on this label.
 2. Set the thermostat to the lowest setting by turning thermostat dial fully clockwise until it stops.
 3. Push the gas control knob down slightly and turn clockwise to "OFF", see Figure 'A'.
- NOTE: Knob cannot be turned from "PILOT" to "OFF" unless knob is pushed down slightly. Do not force.
4. Remove the inner and outer burner doors located below and behind the gas control unit.
 5. Wait five (5) minutes to clear out any gas. If you then smell gas, **STOP!** Follow "B" in the safety information above on this label. If you don't smell gas, go to next step.
 6. This unit is equipped with a push button pilot ignitor, which is used to light the pilot. Locate the ignitor on the gas control.
 7. Turn gas control knob counterclockwise to "PILOT", see Figure 'B'.
 8. The pilot is located on the right side of the burner. It can be located by looking through the burner opening in the jacket while pressing the piezo ignitor button several times. Look for a spark at the pilot location, see Figure 'D'.
 9. Once the pilot has been found, push the gas knob all the way down. Immediately press the pilot ignitor button rapidly (4) to (5) times. If the pilot will not light, repeat step (3) through (9).
 10. Continue to hold the gas control knob down for about one (1) minute after the pilot is lit. Release the gas control knob and it will pop back up. Pilot should remain lit. If it goes out, repeat step (3) through (9). It may take several minutes for air to clear the lines before the pilot will light.
 - If knob does not pop up when released, stop and immediately call your service technician or gas supplier.
 - If the pilot will not stay lit after several tries, turn the gas control knob clockwise to "OFF" and call your service technician or gas supplier, see Figure 'A'.
 11. Replace the inner and outer burner doors.
 12. At arm's length away, turn gas control knob counterclockwise to "ON", see Figure 'C'.
 13. Set thermostat to desired setting.
- DANGER: Hot water increases the risk of scald injury. Consult the instruction manual before changing temperature.**

TO TURN OFF GAS TO APPLIANCE

1. Set thermostat to the lowest setting.
2. Push gas control knob down slightly and turn clockwise to "OFF". Do not force, see Figure A.

FOR YOUR SAFETY READ BEFORE LIGHTING



WARNING: If you do not follow these instructions exactly, a fire or explosion may result causing property damage, personal injury or loss of life.



BEFORE LIGHTING: ENTIRE SYSTEM MUST BE FILLED WITH WATER AND AIR PURGED AT FAUCETS.

- A. This appliance has a pilot which must be lighted by hand. When lighting the pilot, follow these instructions exactly.
- B. **BEFORE LIGHTING:** smell all around the appliance area for gas. Be sure to smell next to the floor because some gas is heavier than air and will settle on the floor.

WHAT TO DO IF YOU SMELL GAS

 - Do not try to light any appliance.
 - Do not touch any electric switch; do not use any phone in your building.
 - Immediately call your gas supplier from a neighbor's phone. Follow the gas supplier's instructions.
- C. If you cannot reach your gas supplier, call the fire department.
- D. Use only your hand to push down or turn the gas control knob. Never use tools. If the knob will not push down or turn by hand, don't try to repair it, call a qualified service technician. Force or attempted repair may result in a fire or explosion.
- E. Do not use this appliance if any part has been under water. Immediately contact a qualified installer or service agency to replace a flooded water heater. Do not attempt to repair the unit! It must be replaced!

LIGHTING INSTRUCTIONS

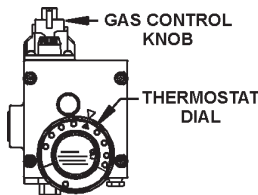

GAS CONTROL

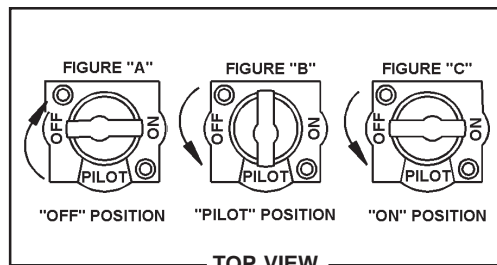

TOP VIEW

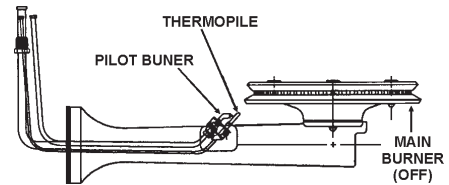

FIGURE "D"

1. **STOP!** Read the safety information above on this label.
2. Set the thermostat to the lowest setting by turning thermostat dial fully clockwise until it stops.
3. Push the gas control knob down slightly and turn clockwise to "OFF". (Figure A).

NOTE: Gas control knob CANNOT be turned from "PILOT" to "OFF" unless it is pushed down slightly. Do not force.
4. Remove the inner and outer burner doors located below and behind the gas control unit.
5. Wait five (5) minutes to clear out any gas. If you then smell gas **STOP!** Follow "B" in the safety information above on this label. If you do not smell gas, go to the next step.
6. Find Pilot: Follow metal tube from the bottom, right of the gas control to the pilot burner. (Figure D).
7. Turn gas control knob counterclockwise to "PILOT". (Figure B).
8. Push gas control knob down all the way and hold it down. Immediately light the pilot with a match. Continue to hold the gas control knob down for about one (1) minute after the pilot is lit. Release the gas control knob and it will pop back up. Pilot should remain lit. If it goes out, repeat Steps 3 through 8. It may take several minutes for air to clear the lines, before the pilot will light.
 - If knob does not pop up when released, stop and immediately call your service technician or gas supplier.
 - If the pilot will not stay lit after several tries, turn the gas control knob to "OFF" (Figure A) and call your service technician or gas supplier.
9. Replace inner and outer burner doors.
10. At arm's length away, turn gas control knob counterclockwise to on. (Figure C).
11. Set thermostat to desired setting (See Figure).



CAUTION: Hotter water increases the risk of scald injury. Consult the instruction manual before changing temperature.

TO TURN OFF GAS TO APPLIANCE

1. Set the thermostat to lowest setting.
2. Push the gas control knob down slightly and turn clockwise to "OFF". (Figure A). Do not force.

TEMPERATURE REGULATION

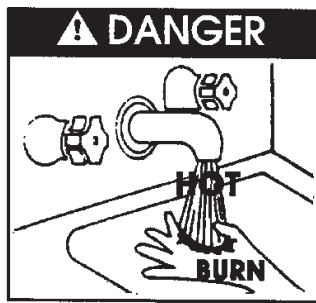

▲ DANGER

THIS WATER HEATER IS EQUIPPED WITH AN ADJUSTABLE THERMOSTAT TO CONTROL WATER TEMPERATURE. HOT WATER TEMPERATURES REQUIRED FOR AUTOMATIC DISHWASHER AND LAUNDRY USE CAN CAUSE PAINFUL SCALDING WITH POSSIBLE SERIOUS AND PERMANENT INJURY. THE TEMPERATURE AT WHICH INJURY OCCURS VARIES WITH THE PERSON'S AGE AND THE TIME OF THE EXPOSURE. THE SLOWER RESPONSE TIME OF CHILDREN, AGED OR DISABLED PERSONS INCREASES THE HAZARDS TO THEM. NEVER ALLOW SMALL CHILDREN TO USE A HOT WATER TAP, OR TO DRAW THEIR OWN BATH WATER. NEVER LEAVE A CHILD OR DISABLED PERSON UNATTENDED IN A BATHTUB OR SHOWER.

THE WATER HEATER SHOULD BE LOCATED IN AN AREA WHERE THE GENERAL PUBLIC DOES NOT HAVE ACCESS. IF A SUITABLE AREA IS NOT AVAILABLE, A COVER SHOULD BE INSTALLED OVER THE THERMOSTAT TO PREVENT TAMPERING. Suitable covers are available through A.O. Smith Water Products Company.

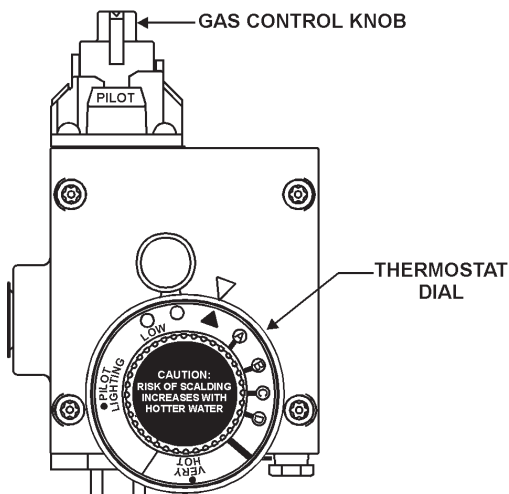

| Temperature Setting | Time to Produce 2nd & 3rd Degree Burns on Adult Skin |
|--------------------------------|--|
| VERY HOT = APPROX.180°F (82°C) | Nearly instantaneous |
| D = APPROX.160°F (71°C) | About 1/2 second |
| C = APPROX.150°F (65°C) | About 1-1/2 seconds |
| B = APPROX.140°F (60°C) | Less than 5 seconds |
| A = APPROX.130°F (54°C) | About 30 seconds |
| ▲ = APPROX.120°F (49°C) | More than 5 minutes |
| LOW = APPROX.100°F (37.8°C) | ----- |

FIGURE 7

It is recommended that lower water temperatures be used to avoid the risk of scalding. It is further recommended, in all cases, that the water temperature dial be set for the lowest temperature which satisfies your hot water needs. This will also provide the most energy efficient operation of the water heater. The water temperature adjusting dial was factory set at the lowest temperature; all the way clockwise to the mechanical stop. Turning the dial counterclockwise increases temperature and clockwise reduces temperature.

SETTING THE WATER HEATER TEMPERATURE AT 120°F (49°C) (APPROX. "▲" MARK ON FACE OF THERMOSTAT) WILL REDUCE THE RISK OF SCALDS. Some states require settings at specific lower temperatures.

Figure 7 shows the approximate water temperatures produced at various thermostat dial settings. Short repeated heating cycles caused by small hot water uses can cause temperatures at the point of use to exceed the thermostat setting by up to 20°F (11°C). If you experience this type of use you should consider using lower temperature settings to reduce scald hazards.

Valves for reducing point of use temperature by mixing cold and hot water are available. Also available are inexpensive devices that attach to faucets to limit hot water temperatures. Contact a licensed plumber or the local plumbing authority.

CHECK VENTING

The following steps shall be followed with each appliance connected to the venting system placed in operation, while any other appliances connected to the venting system are not in operation.

1. Seal any unused openings in the venting system.
2. Inspect the venting system for proper size and horizontal pitch, as required in the National Fuel Gas Code, ANSI Z223.1 or the Natural Gas and Propane Installation Code CAN/CSA-B149.1 and these instructions. Determine that there is no blockage or restriction, leakage, corrosion and other deficiencies which could cause an unsafe condition.
3. So far as is practical, close all building doors and windows and all doors between the space in which the water heater(s) connected to the venting system are located and other spaces of the building. Turn on all appliances not connected to the venting system. Turn on all exhaust fans, such as range hoods and bathroom exhausts, so they shall operate at maximum speed. Close fireplace dampers.
4. Follow the lighting instruction. Place the water heater being inspected in operation. Adjust thermostat so appliance shall operate continuously.
5. Test for draft hood spillage at the relief opening after 5 minutes of main burner operation.
6. After it has been determined that each appliance connected to the venting system properly vents when tested as outlined above, return doors, windows, exhaust fans, fireplace dampers and any other gas burning appliance to their previous conditions of use.
7. If improper venting is observed during any of the above tests, the venting system must be corrected.



WARNING

FAILURE TO CORRECT BACK DRAFTS MAY CAUSE AIR CONTAMINATION AND UNSAFE CONDITIONS.

- If the back draft cannot be corrected by the normal method or if a suitable draft cannot be obtained, a blower type flue gas exhauster must be employed to assure proper venting and correct combustion.

**HIGH TEMPERATURE LIMIT SWITCH
(Auto Reset Type Energy Cut Off)**

TO RESET AUTOMATIC GAS SHUTOFF

This water heater is equipped with a automatic reset type high limit (Energy Cutoff) sensor. The high limit switch interrupts the pilot and main burner gas flow should the water temperature reach 205°F(96°C). The high limit will automatically reset when the water temperature drops below 140°F (60°C).



WARNING

THE GAS VALVE MUST HAVE BEEN IN THE OFF POSITION FOR AT LEAST 5 MINUTES. This waiting period is an important safety step. Its purpose is to permit gas that may have accumulated in the combustion chamber to clear. IF YOU DETECT GAS ODOR AT THE END OF THIS PERIOD DO NOT PROCEED WITH LIGHTING. RECOGNIZE THAT GAS ODOR, EVEN IF IT SEEMS WEAK, MAY INDICATE PRESENCE OF ACCUMULATED GAS SOMEPLACE IN THE AREA WITH RISK OF FIRE OR EXPLOSION. SEE THE FRONT PAGE FOR STEPS TO BE TAKEN.

Before lighting the pilot and operating the heater, the following conditions must exist:

- Entire system filled with water.
- Air purged from all lines and no leaks (gas and water).
- All gas and water lines open.

SHOULD OVERHEATING OCCUR OR THE GAS SUPPLY FAIL TO SHUT OFF, TURN OFF THE MANUAL GAS CONTROL VALVE TO THE APPLIANCE.

SERVICE INFORMATION

The installer may be able to observe and correct certain problems which may arise when the unit is put into operation. HOWEVER, it is recommended that only qualified servicemen, using appropriate test equipment, be allowed to service the heater.

FOR YOUR SAFETY AND SATISFACTORY OPERATION, IT IS RECOMMENDED THAT THIS HEATER BE CHECKED ONCE A YEAR BY A COMPETENT SERVICE PERSON.

USERS OF THIS APPLIANCE SHOULD BE AWARE THAT GAS COMPONENTS WEAR OUT OVER A PERIOD OF TIME. THE GAS CARRYING COMPONENTS OF THIS APPLIANCE SHOULD BE INSPECTED FOR PROPER OPERATION PERIODICALLY BY A QUALIFIED SERVICE TECHNICIAN.

PILOT AND MAIN BURNER

Check pilot and main burner (figure 8) every 12 months for proper flame characteristics. This is done by removing door(s) on heater. The main burner should provide complete combustion of gas;

ignite rapidly; give reasonably quiet operation; cause no excessive flame lifting from the burner ports. Make sure that the flow of combustion and ventilation air is not blocked.

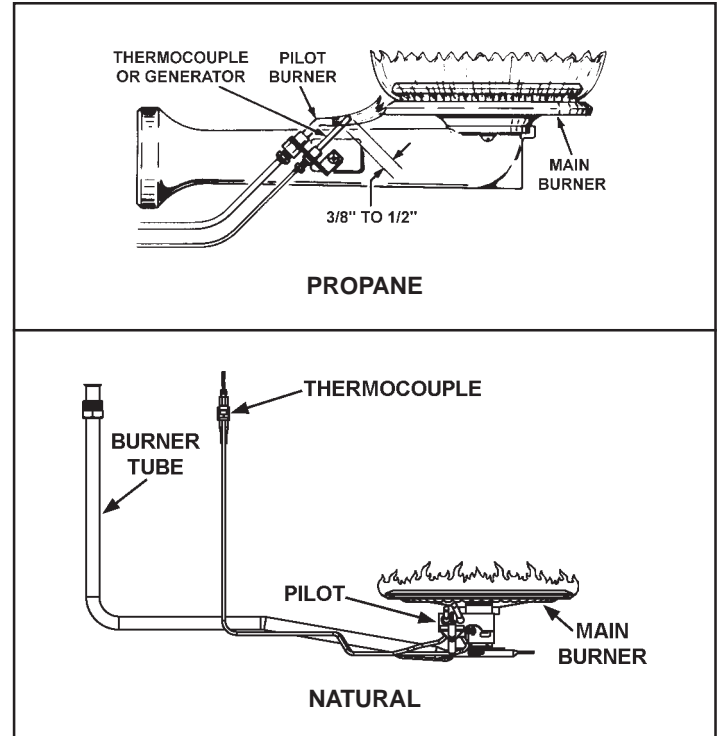

FIGURE 8

If proper flame characteristics are not evident, check for accumulation of lint or other foreign material that restricts or blocks the air openings in the heater or burner.



WARNING

SOOT BUILD-UP INDICATES A PROBLEM THAT REQUIRES CORRECTION BEFORE FURTHER USE. CONSULT WITH A QUALIFIED SERVICE TECHNICIAN.

Should the main burner or burner air openings require cleaning, turn off the gas to the water heater. Follow "to turn off gas to appliance" on pages 10 and 11 and allow the burner to cool. Remove the burner and clean with a soft brush. Clean main burner orifice with a suitable soft material. Follow lighting instructions on pages 10 and 11 to put the water heater back in operation.

CHECK FOR GOOD FLOW OF COMBUSTION AND VENTILATING AIR TO THE UNIT. MAINTAIN A CLEAR OPEN AREA AROUND THE HEATER AT ALL TIMES. DO NOT STORE COMBUSTIBLES OR FLAMMABLE LIQUIDS NEAR OR AROUND AN APPLIANCE.

CHECKING GAS INPUT

For appliance installation locations with elevation above 2000 ft.(610m) refer to HIGH ALTITUDE INSTALLATIONS section of this manual for input reduction procedure.

With this heater in operation, determine whether it is receiving the full rated input of gas. This may be done by timing the gas meter and measuring gas pressure with a gauge or manometer. When the heater is operating at full capacity (full gas input) it should consume approximately 1 cubic foot of gas in the time shown in table 3.

**TABLE 3
INPUT CHECK TIME REQUIRED TO
CONSUME 1 CU. FT. OF GAS**

| Model | Type of Gas | BTU Per Cu. Ft. | Approx. Time Required To Consume 1 Cu. Ft. of Gas |
|--------|-------------|-----------------|---|
| BT-80 | Natural | 1050 | 50.3 sec. |
| | Propane | 2500 | 119.8 sec. |
| BT-100 | Natural | 1050 | 50.3 sec. |
| | Propane | 2500 | 119.8 sec. |

Use this formula to "clock" the meter. Be sure that other gas consuming appliances are not operating during this interval.

$$\frac{3,600}{T} \times H = \text{Btu/Hr}$$

T = Time in seconds needed to burn one cubic foot of gas.

H = Heating value of gas in Btu's per cubic foot of gas.

Btu/Hr = Actual heater input rate.

Example: (Using BT-80 heater)

$$T = 50.3 \text{ seconds/ft}^3$$

$$H = 1,050 \text{ Btu/ft}^3 \text{ (natural gas)}$$

$$\text{Btu/Hr} = ?$$

$$\frac{3,600}{50.3} \times 1,050 = 75,100 \text{ Btu/Hr (22.0 kW)}$$

Compare the actual input rate to that given on the heater's rating plate. In the example, the BT-80's full input rate should be 75,100 Btu/Hr for natural gas.

VENT SYSTEM

Examine the venting system every 6 months for obstructions and/or deterioration of vent piping.

RELIEF VALVE

At least once a year the temperature and pressure relief valve should be checked to ensure that it is in operating condition. (During manual operation of this valve, avoid any contact with hot water and take preventive steps for water damage). Lift the lever at the top of the valve several times until the valve seats properly and operates freely.



WARNING

THE WATER PASSING OUT OF THE VALVE DURING THIS CHECKING OPERATION MAY BE EXTREMELY HOT. AVOID CONTACT AND DISCHARGE SAFELY TO PREVENT WATER DAMAGE.

If the temperature and pressure relief valve on the heater discharges periodically or continuously, a problem exists. This may be due to unusually high water temperatures or pressures in the system, or to a faulty relief valve. Contact your dealer or a qualified service technician to find the cause of the problem and to correct it. This may also be due to thermal expansion in a closed water supply system. Contact the water supplier or local plumbing inspector on how to correct this situation. **DO NOT PLUG THE TEMPERATURE AND PRESSURE RELIEF VALVE.**



WARNING

SHOULD OVERHEATING OCCUR OR THE GAS SUPPLY FAIL TO SHUT OFF, TURN OFF THE MANUAL GAS CONTROL VALVE TO THE APPLIANCE.

HOT WATER ODOR

On occasion, hot water may develop a strong odor. If this occurs drain the heater completely, flush thoroughly, and refill. If the problem persists, chlorination of the heater and replacement of the factory installed magnesium anodes with aluminum anodes may correct the condition.

Occasionally water softener companies recommend removal of heater anodes for odor reasons.



CAUTION

Unauthorized removal of heater anode(s) will void the warranty. Replace the anode as necessary to maintain corrosion protection. For further information contact your dealer.

ANODE ROD INSPECTION

The heater tank is equipped with anode rods to provide corrosion control. At least once a year the anode rods should be checked to determine if replacement is necessary. Initially the anode rods are approximately 7/8" (22mm) in diameter with a 1/8" (3mm) diameter steel core wire running down the center of the anode material. **THE ANODES SHOULD BE REPLACED** when the 1/8" (3mm) diameter core wire is visible as this means that the anode material has been expended in the control of corrosion.

NOTE: Anode rod inspection may need to be made more frequently in areas subject to acid rain that obtains their water supply from surface water as the low pH will accelerate anode activity.

CAUTION: Close cold water inlet valve serving heater and open nearby hot water faucet to relieve the pressure in the heater before attempting to remove anode(s) for inspection.

WINTER PROTECTION

In regions where freezing weather is encountered, all water must be drained from unit and piping when out of service (water shut off). Drain valve must be left open until unit is returned to service.

REPLACEMENT PARTS

Replacement parts may be ordered through A. O. Smith dealers, authorized servicers or distributors. Refer to the Yellow Pages for where to call or contact the A. O. Smith Water Products Company, 125 Southeast Parkway, Franklin, TN 37068 (1-800-433-2545). For Canada call or contact A.O. Smith Water Products Company, 768 Erie Street Stratford, ON N5A 6T3 (519-271-5800 x 401, or visit our website: www.aosmithwaterheaters.com. When ordering parts, be sure to state the quantity, part number and description of the item including the complete model and serial number as it appears on the product. Refer to the parts list for more information.



PREVENTIVE MAINTENANCE

RECOMMENDED PROCEDURE FOR PERIODIC REMOVAL OF LIME DEPOSITS FROM TANK TYPE COMMERCIAL WATER HEATERS

The amount of calcium carbonate (lime) released from water is in direct proportion to water temperature and usage, see chart. The higher the water temperature or water usage, the more lime deposits are dropped out of the water. This is the lime scale which forms in pipes, heaters and on cooking utensils.

Lime accumulation not only reduces the life of the equipment but also reduces efficiency of the heater and increases fuel consumption.

The usage of water softening equipment greatly reduces the hardness of the water. However, this equipment does not always remove all of the hardness (lime). For this reason it is recommended that a regular schedule for deliming be maintained.

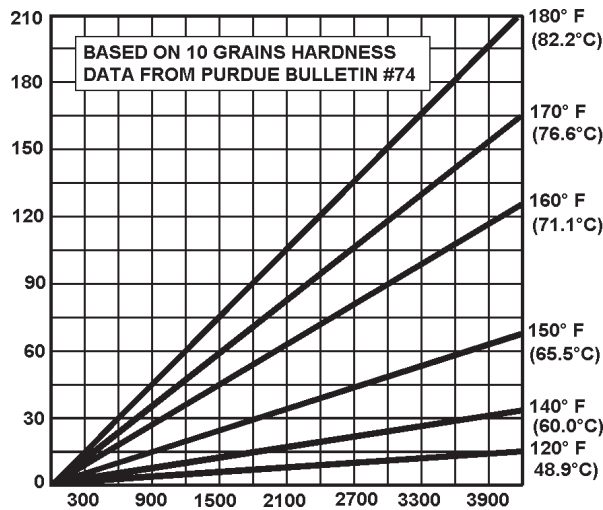

The time between cleaning will vary from weeks to months depending upon water conditions and usage.

Refer to A. O. Smith booklet, Form No. 4800, entitled "Why? When and How" for detailed description on tank inspection and cleanout.

UN•LIME® and the booklet may be obtained through your A. O. Smith dealer or distributor.

DELIMING SOLVENTS

A. O. Smith recommends the use of UN•LIME for delimiting. UN•LIME is a patented food grade acid which is safe to handle and does not create the harmful fumes which are associated with other products.

UN•LIME may be obtained from your dealer, distributor or the A. O. Smith Product Service Division. Order part no. 4763 (1 gal), packed 4 gallons per case or part no. 4813 (5 gallon container).

Hydrochloric base acids are not recommended for use on glass-lined tanks.



CAUTION

Observe handling instructions on label of product being used.

TANK CLEANOUT PROCEDURE

The following practices will ensure longer life and enable the unit to operate at its designed efficiency:

1. Once a month the heater should be flushed. Open the drain valve and allow two gallons of water to drain from the heater. Inlet water valve should remain open to maintain pressure in tank.
2. A cleanout opening is provided for periodic cleaning of the tank. Gas must be shut off and heater drained before opening cleanout.

To clean heater through cleanout opening, proceed as follows:

1. Drain heater.
2. Remove outer cover plate from lower side of heater jacket.
3. Remove six (6) hex head screws securing tank cleanout plate and remove plate.
4. Remove lime, scale, or sediment using care not to damage the glass lining.
5. Inspect cleanout plate gasket, if new gasket is required, see replacement parts list for item number.
6. Install cleanout plate. Be sure to draw plate up tight by tightening screws securely.
7. Replace outer jacket cover plate.

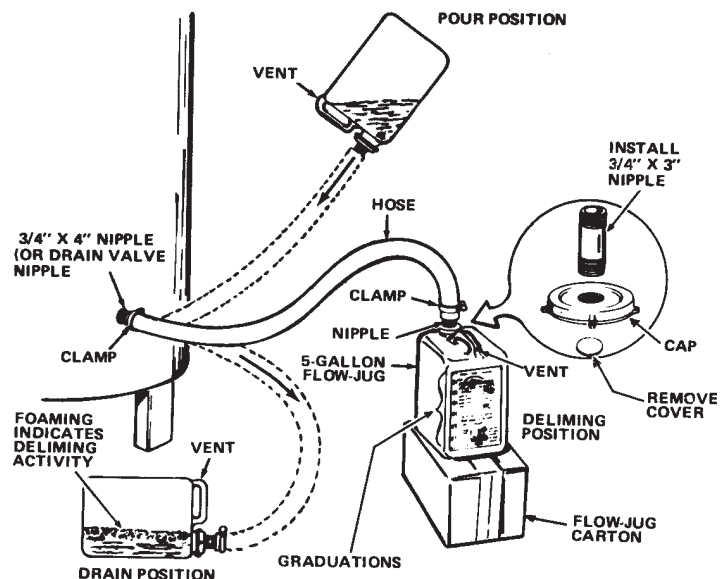

FIGURE 9

In some water areas the sediment might not be removed by this method and may result in the water heater making rumbling or boiling noises. To dissolve and remove these more stubborn mineral deposits, A. O. Smith UN•LIME Professional Delimer should be used.

DELIMING USING FLO-JUG METHOD

UN•LIME in the 5 gallon size is recommended for deliming of the BT-80 and 100 models. UN•LIME with the necessary hoses and fittings to delime your heater is also available as a kit: Up-N-Down Transfer Kit. Contact your local A.O. Smith dealer, distributor or, A.O. Smith Water Products Company, Telephone: (800) 433-2545, Fax: (800) 433-2515 or Website: www.hotwater.com.

Prepare the Water Heater

To delime the water heater using the Flo-Jug method, first prepare the heater for deliming as described in the "Why? When? and How?" booklet, Form No. 4800. Then install the long plastic male adapter fitting into the drain valve opening of the water heater. Use teflon tape and hand tighten only. Do not overtighten.

Prepare the Up-N-Down Transfer Kit

The next step is the preparation on the Up-N-Down Transfer Kit, if you have not already done so:

1. With the 5 gallon Up-N-Down container in the vertical position, unscrew the plastic vent cap in the handle and pierce the plastic membrane over the vent boss under the cap to allow the container to vent.

Note: If your container does not have the vent cap and vent boss, drill a 3/16" (4.76mm) hole in the handle. When you have finished deliming you will be able to plug this drilled vent with the stainless steel screw that is supplied with the kit.

2. Remove the container's cap and cut the plastic membrane located in the 3/4" IPT opening in the cap. Take care to not damage the threads.
3. Find the 3/4" male adapter, apply teflon tape to the threaded end and screw it into the 3/4" IPT opening in the cap.
4. Put cap with male adapter back on the container and slide 3/4" hose over end of male adapter and fasten in place using hose clamp provided.

Delime using Flo-Jug Method

5. Slide the hose clamp over end of hose and slide hose over the male adapter in the water heater drain opening and secure in place using hose clamp.
6. Lift container to the "Pour" Position, see Figure 9, being careful to keep the vent in the handle above the liquid level and pour the UN•LIME into the heater.
7. Lower container, you may have to place the container on its empty carton to prevent the UN•LIME from flowing back into the container.
8. Let UN•LIME remain in the heater for 5 minutes and then lower the container to the "Drain" Position, see Figure 9.
9. Deliming activity is indicated by foaming on the surface of the UN•LIME. If there is deliming activity, repeat steps 6 thru 8.

Normally, lime removal will be completed within one hour. Severe build-up of lime may take longer than an hour to complete descaling.

Note: To check UN•LIME for continued use, place some scale or white chalk in a glass with a small amount of UN•LIME. If the material is vigorously dissolved by the UN•LIME, it can be reused; if not, the UN•LIME should be replaced.

CHECKLIST

Before contacting your dealer, check the water heater to see if the apparent malfunction is caused by some external fault. Consulting this checklist may eliminate the need for a repair call and restore hot water service.

NOT ENOUGH OR NO HOT WATER

1. Check to see if the pilot flame is lit.
 - To relight the pilot, follow the instructions on the heater or in this manual.
 - Check to see if the main gas shutoff valve in the gas supply pipe is partially closed or the water temperature dial is set too low.
2. Look for leaking or open hot water faucets. Check for excessive usage.
3. Your gas company can check the gas input to the heater to see that it is correct. An underfired heater will not produce hot water at its normal recovery rate.
4. If the heater was installed when incoming water temperatures were warm, colder incoming temperatures will create the effect of less hot water.
5. The thermostat water temperature adjusting dial may be set too low.
6. If you cannot determine the cause of the problems, contact your dealer.

WATER TEMPERATURE IS TOO HOT

1. The thermostat water temperature adjusting dial may be set too high.
2. If lowering control setting does not reduce the water temperature contact your dealer.

GAS SMELL AT THE HEATER

1. Close the main shutoff valve in the gas supply pipe near the heater, see fig. 4 on page 7. The thermostat includes a gas control (top knob) which can also be closed.
2. Call your gas company.

WATER LEAKAGE IS SUSPECTED

1. Check to see if the heater drain valve is tightly closed.
2. The apparent leakage might be condensation. In warm or humid locations, condensation can accumulate and run from within the heater or its piping.
 - When a water heater is first installed and filled, the bottom of the tank might condense water. The water accumulation,

if excessive, can drip into the floor shield. Also, during normal operation there may be occasions when large quantities of water are drawn, chilling the tank bottom. This too can result in condensation.

- Condensation, appearing in the vent pipe (water dripping from draft diverter) during heater operation is evidence of poor vent action. Possible causes are too long a vent pipe or improper chimney operation.
3. If the leakage is from the temperature and pressure relief valve or its discharge pipe, it may represent a normal condition. However, see RELIEF VALVE section on page 14. **DO NOT PLUG THE TEMPERATURE AND PRESSURE RELIEF VALVE.** Also, the leakage could be due to unusually high water pressures or temperatures in the system, or to a faulty relief valve. Your dealer or a qualified service technician should be called to determine the cause of the problem and to correct it.
 4. If you cannot identify or correct the source of water leakage:

- Close the main shutoff valve in the gas supply pipe at the heater. See fig. 4, page 7.
- Close the valve which feeds water to the cold water inlet at the top of the heater.
- Contact your dealer.

WATER HEATER MAKES SOUNDS

1. Occasional excessive condensation, as explained under WATER LEAKAGE IS SUSPECTED, can cause a sizzling sound as the moisture is vaporized by the gas flame. This is a normal sound and may be disregarded.
2. Sediment and water scale accumulations may cause rumbling noises. See PREVENTIVE MAINTENANCE or contact your dealer for details of flushing the heater.
3. If you cannot identify or remedy the condition, contact your dealer.

Model BT Limited Warranty

A. O. Smith Corporation, the warrantor, extends the following LIMITED WARRANTY to the owner of this water heater.

1. THE TANK

If the glass-lined tank in this water heater shall prove upon examination by the warrantor to have leaked due to natural corrosion from potable water therein, during the first THREE years after initial installation, the warrantor will supply a complete new A. O. Smith water heater of equivalent size and current model. Some government agencies are requiring energy efficient standards for water heaters. In the event regulations prohibit sale of a model of equivalent size and construction, A. O. Smith will provide a model which complies with the regulations of your area, in which case the consumer will be charged the difference in price between the like replacement and the energy efficient model required. The warranty on the replacement water heater will be limited to the unexpired term of the original warranty.

2. ALL OTHER PARTS

If within ONE year after initial installation of this water heater, any part or portion shall prove upon examination by the warrantor to be defective in material or workmanship, the warrantor will repair or replace such part or portion at its option.

3. CONDITIONS AND EXCEPTIONS

This warranty shall apply only when the water heater is installed in accordance with local plumbing and building codes, ordinances and regulations, the printed instructions provided with it and good industry practices. In addition, a temperature and pressure relief valve, certified by and officially sanctioned and recognized independent testing agency and approved by the American Society of Mechanical Engineers, must have been installed.

- a. This warranty shall apply only when the heater is:
 - (1) used at temperatures not exceeding the maximum calibrated setting of its thermostat;
 - (2) used at water pressure not exceeding the working pressure shown on the heater;
 - (3) filled with potable water, free to circulate at all times and with the tank free of damaging water sediment or scale deposits;
 - (4) used in a non-corrosive and non-contaminated atmosphere;
 - (5) used with factory approved anode(s) installed;
 - (6) in its original installation location;
 - (7) in the United States, its territories or possessions;
 - (8) sized in accordance with proper sizing techniques for commercial and/or residential water heaters;
 - (9) bearing a rating plate which has not been altered, defaced or removed, except as required by the warrantor;
 - (10) used in an open system or in a closed system with properly sized and installed thermal expansion tank;
 - (11) operated with properly installed dirt leg;
 - (12) fired with the fuel for which it was factory built;
 - (13) fired at the factory rated input;
 - (14) operated with the inner and outer combustion chamber doors in place.
- b. Any accident to the water heater, any misuse, abuse (including freezing or thermal expansion damage) or alteration of, any operation in a modified form, or any attempt to repair tank leaks will void this warranty.
- c. This warranty is void if a device acting as a backflow prevention device (check valves etc.) is installed in the cold water supply the heater is connected to, unless an effective method of controlling thermal expansion is also installed at the heater(s) and operational at all times. The relief valve installed on the heater is not an acceptable method.

4. SERVICE AND REPAIR EXPENSES

Under the limited warranty the warrantor will provide only a replacement water heater or part thereof. The owner is responsible for all other costs. Such costs may include but are not limited to:

- a. Labor charges for service removal, repair or reinstallation of the water heater or any component part;
- b. Shipping, delivery, handling, and administrative charges for forwarding the new heater or replacement part from the nearest distributor and returning the claimed defective heater or part to such distributor.
- c. All cost necessary or incidental for any material and/or permits required for installation of the replacement heater or part.

5. LIMITATIONS ON IMPLIED WARRANTIES

Implied warranties, including the warranty of merchantability imposed on the sale of this heater under state law are limited to one (1) year duration for the heater or any of its parts. Some states do not allow limitation on how long an implied warranty lasts, so the above limitation may not apply to you.

6. CLAIM PROCEDURE

Any claim under the warranty should be initiated with the dealer who sold the heater, or with any other dealer handling the warrantor's products. If this is not practicable, the owner should contact:

| | |
|------------------------------------|------------------------------|
| U.S. Customers | Canadian Customers |
| A. O. Smith Water Products Company | A. O. Smith Enterprises Ltd. |
| 500 Tennessee Waltz Parkway | 768 Erie Street |
| Ashland City, TN 37015 | Stratford (Ontario) N5A 6T3 |
| Telephone: (800) 527-1953 | Telephone: (800) 265-8520 |

- a. The warrantor will only honor replacement with identical or similar water heater or parts thereof which are manufactured or distributed by the warrantor.
- b. Dealer replacements are made subject to in-warranty validation by warrantor.

7. DISCLAIMERS

NO OTHER EXPRESS WARRANTY HAS BEEN OR WILL BE MADE IN BEHALF OF THE WARRANTOR WITH RESPECT TO THE MERCHANTABILITY OF THE HEATER OR THE INSTALLATION, OPERATION, REPAIR OR REPLACEMENT OF THE HEATER. THE WARRANTOR SHALL NOT BE RESPONSIBLE FOR WATER DAMAGE, LOSS OF USE OF THE UNIT, INCONVENIENCE, LOSS OR DAMAGE TO PERSONAL PROPERTY OR OTHER CONSEQUENTIAL DAMAGE. THE WARRANTOR SHALL NOT BE LIABLE BY VIRTUE OF THIS WARRANTY OR OTHERWISE FOR DAMAGE TO ANY PERSONS OR PROPERTY, WHETHER DIRECT OR INDIRECT, AND WHETHER ARISING IN CONTRACT OR IN TORT.

- a. Some states do not allow the exclusion or limitation of the incidental or consequential damage, so the above limitations or exclusions may not apply to you.
- b. This warranty gives you specific legal rights, and you may also have other rights which vary from state to state.

Fill in the following for your own reference. Keep it. Registration is not a condition of warranty. The model and serial number are found on the heater's rating plate.

Model No. _____ Serial No. _____ Date Installed _____

Dealer's Name _____

Dealer's Address _____ Phone No. _____

City and State _____ Zip _____

KEEP THIS WARRANTY POSTED ADJACENT TO THE HEATER FOR FUTURE REFERENCE.

A.O. Smith
Water Heaters

A.O. SMITH WATER PRODUCTS COMPANY
500 Tennessee Waltz Parkway • Ashland City, TN 37015
PHONE: 1-800-527-1953
www.aosmithwaterheaters.com • E-MAIL: parts@hotwater.com