

Quality is more than a word

ESPEC

Bench-Top Type Temperature (& Humidity) Chamber

SH·SU



Compact design for personal use, to network with your computer.

The Bench-top Type Temperature (& Humidity) Chamber Series features environmental testing performance in a compact design. Available in 20L and 60L capacities, these models offer temperature range from -20 , -40 , or -60°C , to $+150$ or $+180^{\circ}\text{C}$, while achieving excellent performance.

The chamber comes with user-friendly touch panel display, allows three-way access to the chamber, and offering broader range of options for superior expandability.

SH-242



SH-662



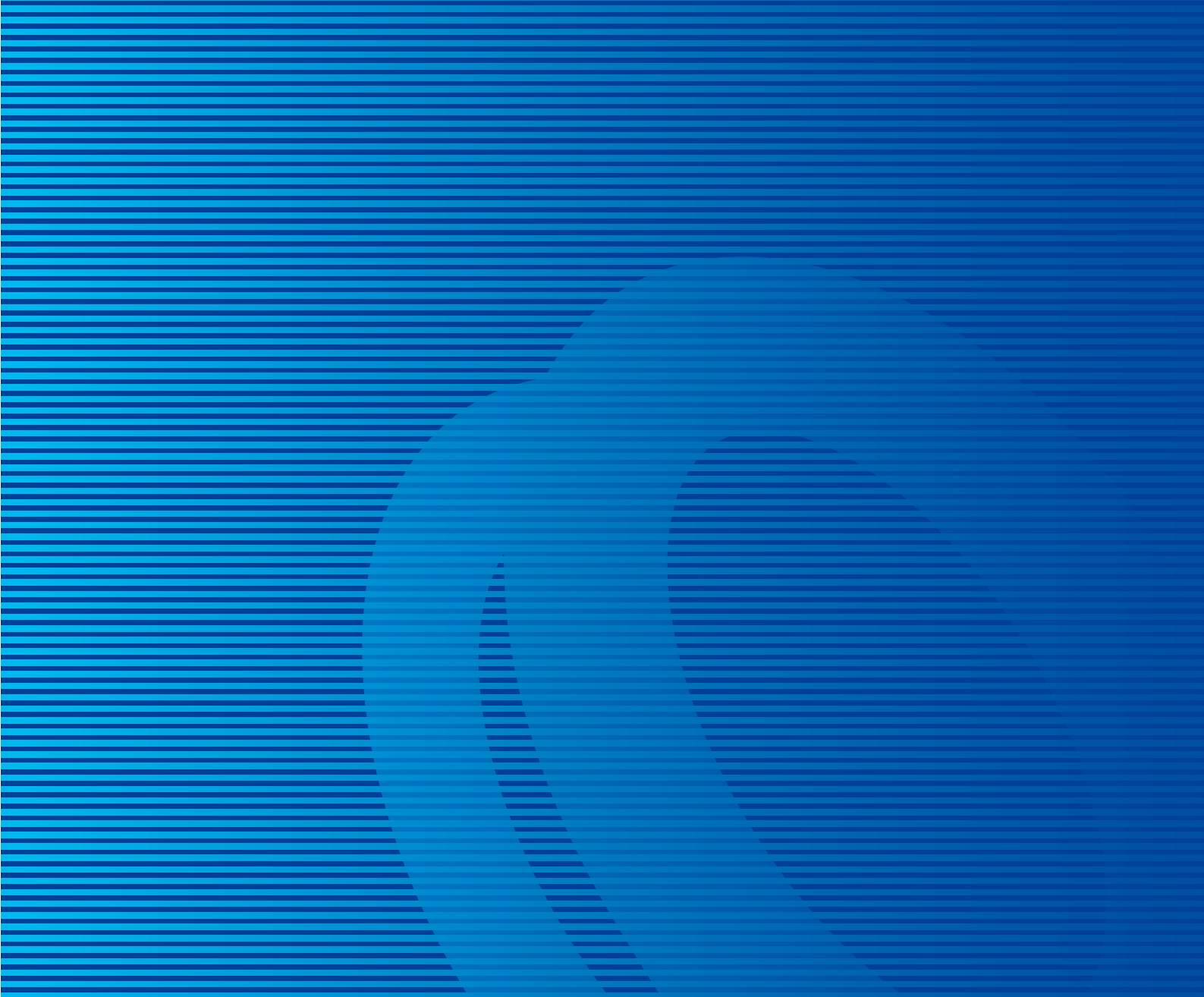

* Shown are equipped with options. (Standard: ϕ 50mm cable port on the right (not shown))

Characteristics

High performance in a box



● Wide variation

With its 3 temperature range patterns (to -60 , -40 or -20°C) and 2 volumes (22.5L and 64 L) selection, the Bench-top chamber offers 12 models in temperature or temperature/ humidity configuration, to fulfil customers' needs.

● Full-size chamber performance in a compact design

All our models now have a temperature range that extends up to 180°C , with a humidity range running from 30 to 95% rh, in a small and light structure that can even fit on a desk (22.5L model).



Test area (SH-662)

● Improved performance to meet test severity

In addition to the extensive range of Bench-top models available, we developed a model with a heat up performance of 5k/ min., as a response to the recent demands in various industries for reliability testing.

● Optimization of the chamber top space

The top of the chamber is rearranged with a free space, to tidy running cables, or put a measuring instrument, a notebook, or whatever equipment you need to keep close to the chamber.

(Patent pending)

(not available on 242-5 models)



Chamber top free space (SH-262)

Characteristics

- **Carts' variation to optimize chambers' footprint (option)**

A wide selection of carts is available from the simple stand to option-mounted base.

Equipped of casters, you can use them to arrange your equipment and save space by stacking chambers and moving them whenever necessary.

(See page 21 for details)

- **Stands**

Available in 3 different heights, total of 9 variations. Mid and high stands come with a shelf, an option box or a 19 inch rack. You can also select a mid stand with build-in 18 liter water tank to supply water for extended duration of humidity testing.

- **Selection of the water supply method (Option - SH type only)**

A water tank is equipped as standard and can be accessed from the chamber front.

In addition to this tank we have also prepared other supply methods, should longer and continuous testing be necessary: continuous water supply, roof-top water tank.

- **User-friendly features**

The environment of the chamber is safe and quiet thanks to several options, such as the automatic water refill for the chamber humidity tray, or the noise reduction rear side cover, that also directs heat dissipation towards the ceiling for safe installation in your office.



Example of stacked chambers (H and C stands)



L stand with water tank *Portable tank is not included.

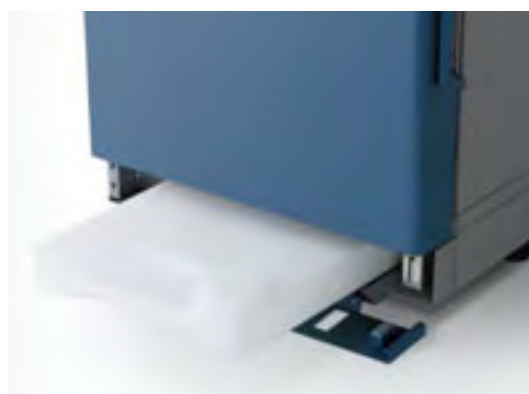

Water supply tank

Characteristics



Viewing window (option)

- **Viewing window**

Viewing window allows you to observe and check the status of test specimen during a test. The window comes with a transparent metal deposited thin film heater to prevent it from fogging. The window can be mounted on the door or the top of the chamber.

- **Various ways to "observe", "touch", and "manipulate"**

Viewing window allows you to see test specimen during a test, but you can also add an Inner glass door, with or without hand-in port, for more wide view inside the chamber and for the manipulation of specimen under test. (Viewing window on the door and Inner glass door cannot be fitted together.)

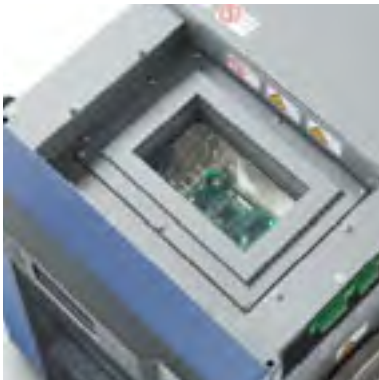

Roof top viewing window (option)



inner glass door



Hand-ini port

Characteristics

- **Standard equipped instrumentation interlock input/output terminals**

These terminals are installed as standard on the chamber. Use the input terminal to synchronize instrumentation, or command the start/ stop of the chamber according to set program, etc.

- **Three-way access**

Chamber comes with a $\phi 50\text{mm}$ cable port on the right as a standard but you can also add more cable ports on the left as well as atop.

- **Cable port plug with embedded terminal (option)**

Easier connection between test specimen and external peripherals. Less time required for a test preparation.

- **Noise reduction rear cover (option)**

A cover is added on the rear side of the chamber to direct exhaust air toward the top and reducing the noise, while hiding cables and wires as necessary.

- **Cable Organizer Kit (option)**

The kit is to help you organize the perimeter of the chamber, gathering cables and wires, and hide them under a cover for a neater look.

The kit include: cable ties to gather cables; a cable cover to secure cables; and dew tray to catch dripping dews from cable port.



Instrumentation interlock terminals



Left side $\phi 100$ Cable port (option)



Noise reduction rear cover

Cable organizer kit (Cable cover)

Characteristics



Backtrace setting

● Online Diagnostics Service

(<http://www.espec.co.jp/english/support/onlinediagnosticservice.html>)



● Backtrace function

Backtrace data are created when the chamber triggers an alarm. All items required for chamber control including set temperature and humidity, measured temperature and humidity, etc. are recorded for the period before and after the alarm was triggered.

When the chamber stops because of trouble, the operation state just before the chamber stops is automatically recorded and saved. Saved data can be sent to ESPEC, by using our Online Diagnostics Service, and we will perform troubleshooting.

● Online Diagnostics Service

Online Diagnostics service is available using the backtrace data recorded by the chamber. Send the backtrace data to ESPEC via email; we will analyse the cause of the trouble and report the diagnosis back to you.

This service ensures accurately-performed diagnosis s that, in case repair work is required, appropriate troubleshooting will be prescribed ensuring reduced testing downtime.

● International standards

Complies with Safety of Machinery (ISO 12100), Low Voltage (IEC 60204), EMC (IEC 61000-6-2, IEC 61000-6-4).

Benchtop chambers meet RoHS standard.

All the Platinous J programming featured in a compact format

● N-instrumentation equipped with a color LCD touch panel

In the size of a smartphone screen, we replicate the easy-to-use Platinous N-instrumentation for the Bench-Top chamber.

Efficient and simple, ESPEC users will appreciate the homogeneity in our product lineup.

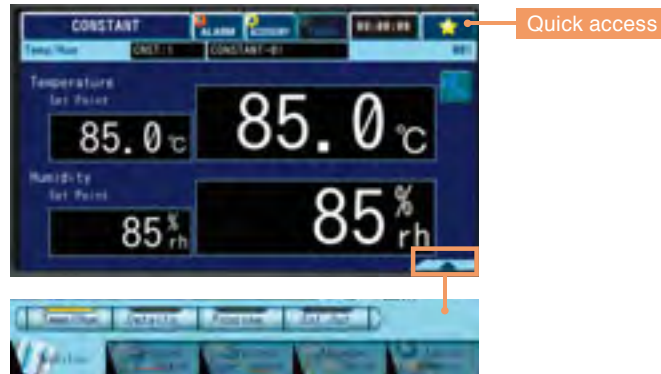

● Quick access button

The star mark (★) on the right top corner of the controller can be set to have instant access to any age you often need, either the constant operation start, on else.

● Information Button

When there are some things need to be notified to the operator, the Accessory button will switch to Infomation button. By pressing the button, you will find notifications such as "Check Humidity Tray" and "Check Wet Bulb Wick".

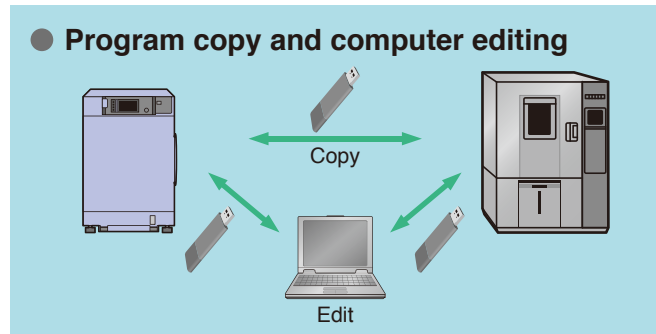

● 8 patterns 99 steps

The controller allows you to register 3 constant operation settings or 8 program operation settings with maximum of 99 steps per program.



USB port

● Copy of program patterns

Transfer the programs between chambers without the need of a PC, via USB stick.
* The USB memory is not included.

● Trend graph output on USB memory

Trend graphs can be displayed on the web application or downloaded on a USB memory. It is also possible to continuously register data on the USB memory if numerous data records are needed.

* Reference: Data log with an interval of 30 sec., can be registered for 113 days and 18 hours.

● Multilingual display

A simple operation changes display text to Japanese, Chinese (simplified, traditional), or Korean. Select the language that suits your needs.

N-instrumentation

Operating mode	Constant operation, program operation, remote operation, stop
Setting range	<ul style="list-style-type: none"> Constant setup 3 patterns Setting range: Temp.: (Lowest attainable temp. -5°C) to (Highest attainable temp. +10°C), 0.1°C unit Humidity: 0 to 100% rh, 1% unit Program setup 8 patterns (99 steps) Setting range: (Lowest attainable temp. -5°C) to (Highest attainable temp. +10°C), 0.1°C unit Humidity: 0 to 100% rh, 1% unit Time: 0 hour and 1 min. to 9999 hours and 59 min. 1 min. unit
Language	Japanese, English, Chinese (simplified, traditional), Korean
External memory function	Interface: USB 2.0 standard compliant (A-type connector) Supported functions: <ul style="list-style-type: none"> Write sampling data, Read/ Write program (application software: Patten Manager Lite) Backtrace output
Web function	Interface: Ethernet port (100base-TX) Web applications: monitoring, setting, operation, maintenance setting, email alert Browser: Windows Internet Explorer 10

Remote monitoring and control thanks to a Web application



- **Remote monitoring and control (Ethernet connection)**

A unique web application allows the user to monitor the chamber, set programs, and start and stop operation from a PC connected to the chamber Ethernet port (LAN's port). No software required, the chamber can be accessed and controlled from any PC via a web browser (Smartphone, tablets and the like can also be used).

Wireless connection and multiple units' connection are also possible.

- **Email alert**

When an alarm is triggered, an e-mail is sent to the registered PC or mobile address. A notification can also be sent at the time of test completion. Set the recipient mail address from the Maintenance setting screen.

*Requires an intranet environment capable of sending emails.

- **Multilingual display**

The language available for the Web Manager (Japanese/ English/ Simplified Chinese/ Traditional Chinese/ Korean) can be changed without affecting the N-instrumentation language display.

- **Web camera**

By connecting the optional webcam with terminal, you can view the specimen in the chamber on the controller or on a connected computer without interrupting a test.

- **Programming**



- **Graph display**



- **Email alert**

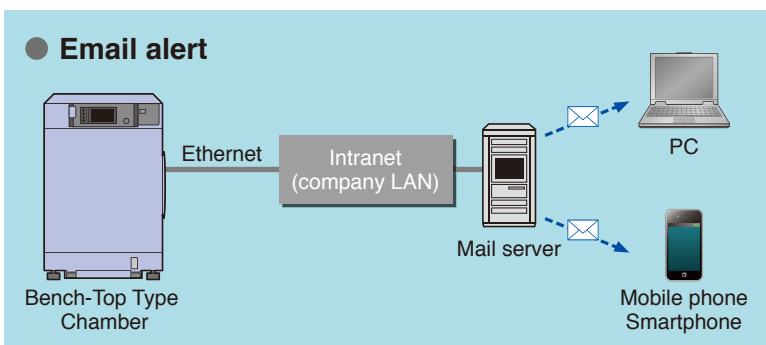

Mounted Web camera



Web Application snapshot

Pattern Manager Lite software: Get the most out of USB memory

Download programs online

Via the Pattern Manager Lite software installed on your PC, edit programs according to your testing needs, and upload them with a USB.

Copy and reproduce testing

You can copy the same test program in multiple chambers, provided that they have the same operation range, thanks to the USB memory. No need to program each chamber, just connect the USB and the test can start.

Edit programs

Through our online website Test Navi, dedicated to reliability and testing information, you can find most of the recognized international standard, available for download.

Charge them as is on your USB memory, or edit them and transfer to your chamber.

* Test Navi is a website dedicated to reliability testing information and technologies. <http://www.test-navi.com/eng/index.html>

The Pattern Manager Lite software allow you to edit programs for your chamber, view and edit data as graph, etc. The software can be downloaded from the Test Navi website.

Web Integrated Network (Sold separately)

Ideal for customers who needs to manage lots of testing chambers or measuring devices.

From a single screen on your browser, check and control your equipment fleet remotely. (Up to 100 devices)

You can manage test scheduling, equipment performances, and use this versatile system in many ways.

Other devices including manufacturers' chambers, or measuring equipment are compatible (LAN connection required).

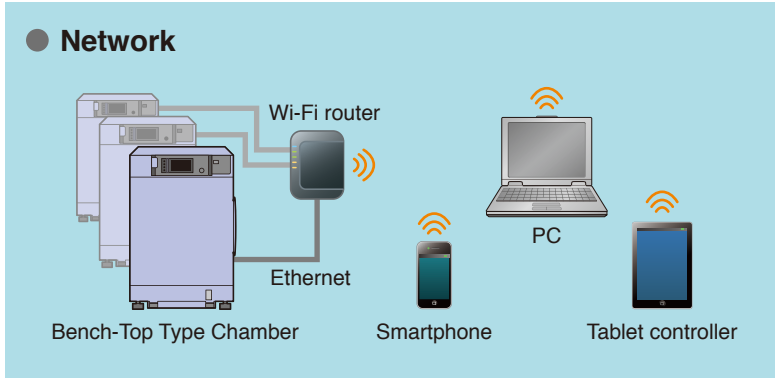

Test Navi (<http://www.test-navi.com/eng/index.html>)

This website provides practical knowledge on environmental testing that ESPEC has acquired through years of experience, as well as covering everything from the fundamentals to the latest information on environmental and reliability testing.

Product Registration Membership Website

- Updates for chamber controller software
- Search for environmental test standards

Environmental Test Standards
For Pattern Manager Lite
Test methods download

- Download test profiles from a list of environmental test standards

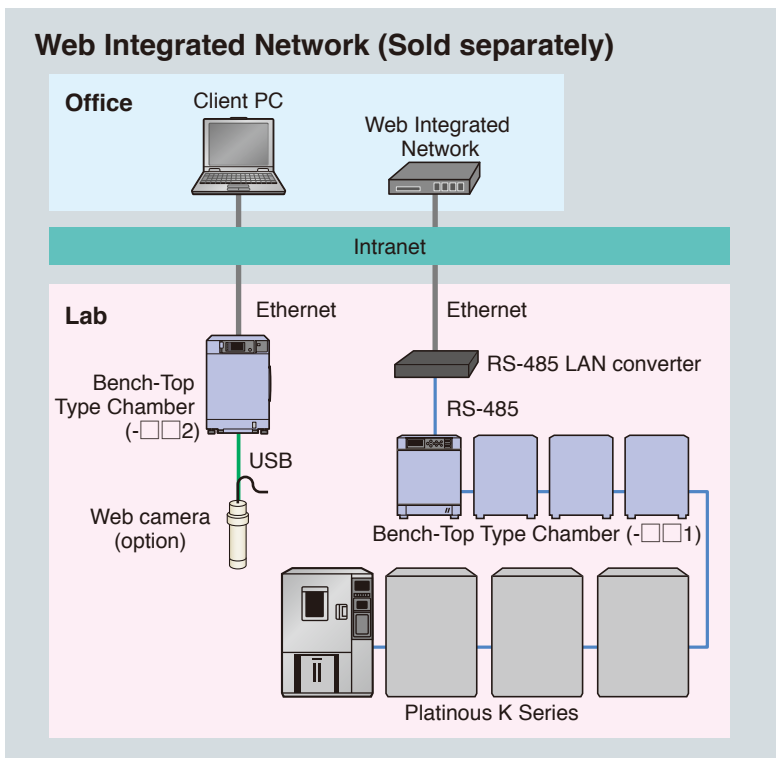

Model	SH-222	SH-242	SH-262	SH-642	SH-662	SH-242-5		
System	Balanced Temperature & Humidity Control system (BTHC system)							
Temp. performance ^{*1}	Temp. range	-20 to +150°C (-4 to +302°F)	-40 to +150°C (-40 to +302°F)	-60 to +150°C (-76 to +302°F)	-40 to +150°C (-40 to +302°F)	-60 to +150°C (-76 to +302°F)	-40 to +150°C (-40 to +302°F)	
	Temp. fluctuation	±0.3°C (-20 to +100°C) ±0.5°C (+100.1 to +150°C)	±0.3°C (-40 to +100°C) ±0.5°C (+100.1 to +150°C)	±0.3°C (-60 to +100°C) ±0.5°C (+100.1 to +150°C)	±0.3°C (-40 to +100°C) ±0.5°C (+100.1 to +150°C)	±0.3°C (-60 to +100°C) ±0.5°C (+100.1 to +150°C)	±0.3°C (-40 to +100°C) ±0.5°C (+100.1 to +150°C)	
	Temp. gradient / Temp. variation in space	2.5°C (-20 to +100°C) 4.0°C (+100.1 to +150°C)	2.5°C (-40 to +100°C) 4.0°C (+100.1 to +150°C)	2.5°C (-60 to +100°C) 4.0°C (+100.1 to +150°C)	2.5°C (-40 to +100°C) 4.0°C (+100.1 to +150°C)	2.5°C (-60 to +100°C) 4.0°C (+100.1 to +150°C)	2.5°C (-40 to +100°C) 4.0°C (+100.1 to +150°C)	
	Temp. rate of change	Heat up rate	3.2°C /min.			2.9°C /min.		5.0°C /min.
		Pull down rate	2.1°C /min.			1.7°C /min.		5.0°C /min.
	Temp. extreme achievement time Heat up time	From -20 to +150°C within 55 min.	From -40 to +150°C within 60 min.	From -60 to +150°C within 70 min.	From -40 to +150°C within 70 min.	From -60 to +150°C within 80 min.	From -40 to +150°C within 40 min.	
	Temp. extreme achievement time Pull down time	From +20 to -20°C within 20 min.	From +20 to -40°C within 50 min.	From +20 to -60°C within 70 min.	From +20 to -40°C within 60 min.	From +20 to -60°C within 90 min.	From +20 to -40°C within 20 min.	
	Lowest attainable temp.	-20°C	-40°C	-60°C	-40°C	-60°C	-40°C	
Humid. performance ^{*1}	Humid. range	30 to 95% rh (Refer to diagram on page 12)						
	Humid. fluctuation	±3.0% rh						
Construction	Heater	Nichrome strip wire heater						
	Humidifier	Stainless steel cartridge heater						
	Refrigeration unit	System	Mechanical single-stage refrigeration system		Mechanical cascade refrigeration system			
		Cooler	Plate fin cooler					
		Refrigerator	Hermetically sealed compressor, Air-cooled condenser, Expansion mechanism: Capillary tube system					
		Refrigerator capacity	400W		[Unit 1: 400W ×1, Unit 2: 400W ×1]			
Refrigerant		R404A		R23, R404A				
Capacity	22.5 L			64 L		22.5 L		
Chamber total load resistance	20 kg							
Inside dimensions mm (inch) ^{*2}	W300×H300×D250 (W11.81×H11.81×D9.84)			W400×H400×D400 (W15.75×H15.75×D15.75)		W300×H300×D250 (W11.81×H11.81×D9.84)		
Outside dimensions mm (inch) ^{*2}	W440×H690×D695 (W17.32×H27.18×D27.36)		W440×H690×D785 (W17.32×H27.18×D30.91)	W540×H730×D920 (W21.26×H28.74×D36.22)		W440×H690×D785 (W17.32×H27.18×D30.91)		
Weight	83 kg (78 for 100V type)		105 kg	130 kg		106 kg		
Utility requirements	Allowable ambient conditions	+5 to +35°C (+41 to +95°F)						
	Power supply ^{*3}	100V AC 1φ50/60Hz	14.5 A	18.0 A	21.0 A		21.0 A	
		115V AC 1φ60Hz	14.0 A	—				
		200V AC 1φ50/60Hz ^{*4}	—	14.0 A	14.5 A		15.5 A	
		220V AC 1φ50/60Hz ^{*5}	10.0 A	13.5 A	14.0 A		15.0 A	
230V AC 1φ50Hz ^{*5}	9.5 A	13.5 A	14.0 A		15.0 A			
Noise level ^{*6}	Between 42 and 52 dB		Between 42 and 56 dB	Between 48 and 59 dB		Between 42 and 56 dB		
Exhaust heat quantity	3500 kJ/h (836 kcal/h)		4000 kJ/h (955 kcal/h)	5040 kJ/h (1204 kcal/h)		5700 kJ/h (1361 kcal/h)		

^{*1} The performance values are based on IEC 60068-3-5:2001, JTM K07:2007 for the temperature chamber, IEC 60068-3-6:2001, JTM K09:2009 for the humidity chamber. Performance figures are given for a +23°C ambient temperature, 65% rh, rated power supply and no specimens inside the test area. However, the lowest attainable temperature is given for a max. ambient temperature of +30°C. Heat-up time is the achieved time from lowest temperature to highest temperature within temperature range.

^{*2} Excluding protrusions.

^{*3} At ambient temperature +23°C.

^{*4} 200V AC available with or without NEC specifications. SH-242-5 not available with NEC specification.

^{*5} Compliance with CE Marking.

^{*6} Measurements are to be taken in an anechoic room at a height of 1.2m from the floor and a distance of 1m from the chamber front panel (ISO 1996-1:2003 _ A-weighted sound pressure level)

TEMPERATURE & HUMIDITY CONTROL RANGE (SH)

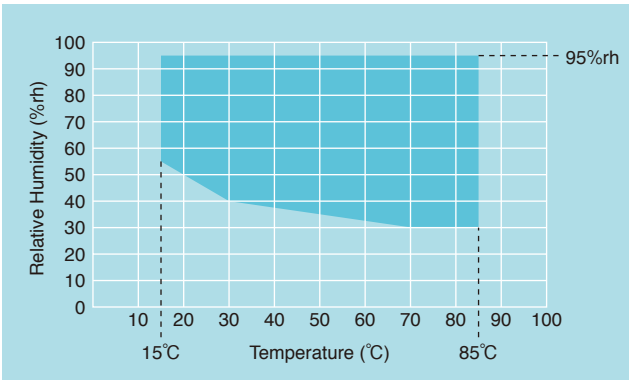

* At ambient temperature +23°C

DIMENSIONS

unit:mm

● SH-222·242

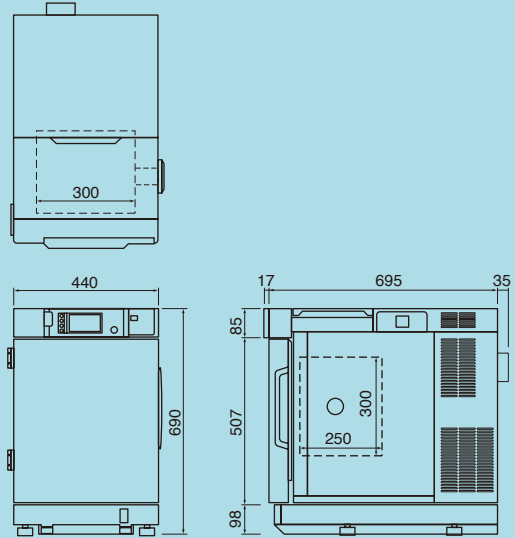

● SH-242-5·262

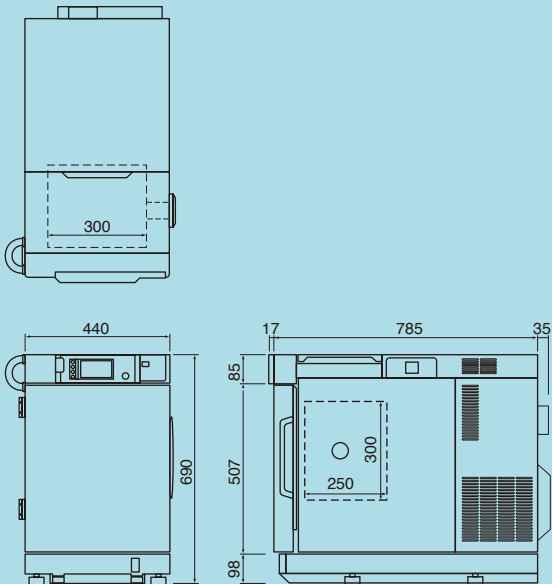

● SH-642·662

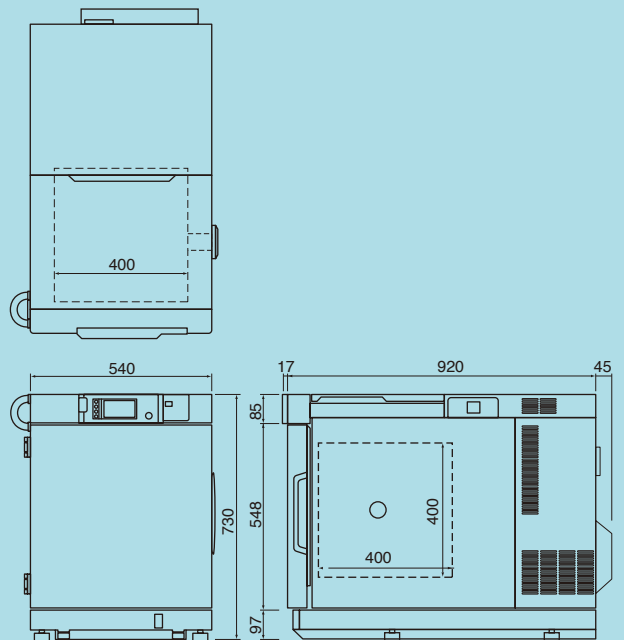

Model	SU-222	SU-242	SU-262	SU-642	SU-662	SU-242-5		
System	Balanced Temperature Control system (BTC system)							
Temp. performance ¹	Temp. range	-20 to +150°C (-4 to +302°F)	-40 to +150°C (-40 to +302°F)	-60 to +150°C (-76 to +302°F)	-40 to +150°C (-40 to +302°F)	-60 to +150°C (-76 to +302°F)	-40 to +150°C (-40 to +302°F)	
	Temp. fluctuation	±0.3°C (-20 to +100°C) ±0.5°C (+100.1 to +150°C)	±0.3°C (-40 to +100°C) ±0.5°C (+100.1 to +150°C)	±0.3°C (-60 to +100°C) ±0.5°C (+100.1 to +150°C)	±0.3°C (-40 to +100°C) ±0.5°C (+100.1 to +150°C)	±0.3°C (-60 to +100°C) ±0.5°C (+100.1 to +150°C)	±0.3°C (-40 to +100°C) ±0.5°C (+100.1 to +150°C)	
	Temp. gradient / Temp. variation in space	2.5°C (-20 to +100°C) 4.0°C (+100.1 to +150°C)	2.5°C (-40 to +100°C) 4.0°C (+100.1 to +150°C)	2.5°C (-60 to +100°C) 4.0°C (+100.1 to +150°C)	2.5°C (-40 to +100°C) 4.0°C (+100.1 to +150°C)	2.5°C (-60 to +100°C) 4.0°C (+100.1 to +150°C)	2.5°C (-40 to +100°C) 4.0°C (+100.1 to +150°C)	
	Temp. rate of change	Heat up rate	3.2°C /min.			2.9°C /min.		5.0°C /min.
		Pull down rate	2.1°C /min.			1.7°C /min.		5.0°C /min.
	Temp. extreme achievement time Heat up time	From -20 to +150°C within 55 min.	From -40 to +150°C within 60 min.	From -60 to +150°C within 70 min.	From -40 to +150°C within 70 min.	From -60 to +150°C within 80 min.	From -40 to +150°C within 40 min.	
	Temp. extreme achievement time Pull down time	From +20 to -20°C within 20 min.	From +20 to -40°C within 50 min.	From +20 to -60°C within 70 min.	From +20 to -40°C within 60 min.	From +20 to -60°C within 90 min.	From +20 to -40°C within 20 min.	
	Lowest attainable temp.	-20°C	-40°C	-60°C	-40°C	-60°C	-40°C	
	Heater	Nichrome strip wire heater						
Construction Refrigeration unit	System	Mechanical single-stage refrigeration system		Mechanical cascade refrigeration system				
	Cooler	Plate fin cooler						
	Refrigerator	Hermetically sealed compressor, Air-cooled condenser, Expansion mechanism: Capillary tube system						
	Refrigerator capacity	400W		[Unit 1: 400W ×1, unit 2: 400W ×1]				
	Refrigerant	R404A		R23, R404A				
Capacity	22.5 L			64 L		22.5 L		
Chamber total load resistance	20 kg							
Inside dimensions mm (inch) ²	W300×H300×D250 (W11.81×H11.81×D9.84)		W300×H300×D250 (W11.81×H11.81×D9.84)	W400×H400×D400 (W15.75×H15.75×D15.75)		W300×H300×D250 (W11.81×H11.81×D9.84)		
Outside dimensions mm (inch) ²	W440×H620×D695 (W17.32×H24.41×D27.36)		W440×H620×D785 (W17.32×H24.41×D30.91)	W540×H660×D920 (W21.26×H25.98×D36.22)		W440×H620×D785 (W17.32×H24.41×D30.91)		
Weight	78 kg (73 for 100V type)		100 kg	123 kg		101 kg		
Utility requirements ³	Allowable ambient conditions	+5 to +35°C (+41 to +95°F)						
	Power supply	100V AC 1φ50/60Hz	12.5 A	18.0 A	21.0 A		21.0 A	
		115V AC 1φ60Hz	12.0 A	—				
		200V AC 1φ50/60Hz ⁴	—	14.0 A	14.5 A		15.5 A	
		220V AC 1φ50/60Hz ⁵	9.0 A	13.5 A	14.0 A		15.0 A	
		230V AC 1φ50Hz ⁵	8.5 A	13.5 A	14.0 A		15.0 A	
Noise level ⁶	Between 42 and 52 dB		Between 42 and 56 dB	Between 48 and 59 dB		Between 42 and 56 dB		
Exhaust heat quantity	3500 kJ/h (836 kcal/h)		4000 kJ/h (955 kcal/h)	5040 kJ/h (1204 kcal/h)		5700 kJ/h (1361 kcal/h)		

¹ The performance values are based on IEC 60068-3-5:2001, JTM K07:2007 for the temperature chamber, IEC 60068-3-6:2001, JTM K09:2009 for the humidity chamber. Performance figures are given for a +23°C ambient temperature, 65% rh, rated power supply and no specimens inside the test area. However, the lowest attainable temperature is given for a max. ambient temperature of +30°C. Heat-up time is the achieved time from lowest temperature to highest temperature within temperature range.

² Excluding protrusions.

³ At ambient temperature +23°C.

⁴ 200V AC available with or without NEC specifications. SU-242-5 not available with NEC specification.

⁵ Compliance with CE Marking.

⁶ Measurements are to be taken in an anechoic room at a height of 1.2m from the floor and a distance of 1m from the chamber front panel (ISO 1996-1:2003 _ A-weighted sound pressure level)

DIMENSIONS

unit:mm

● SU-222·242

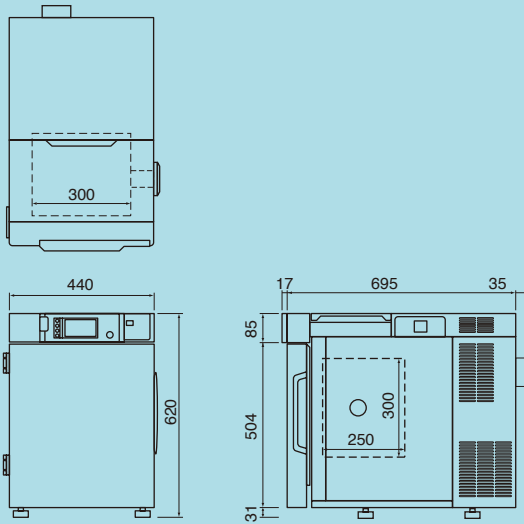

● SU-242-5·262

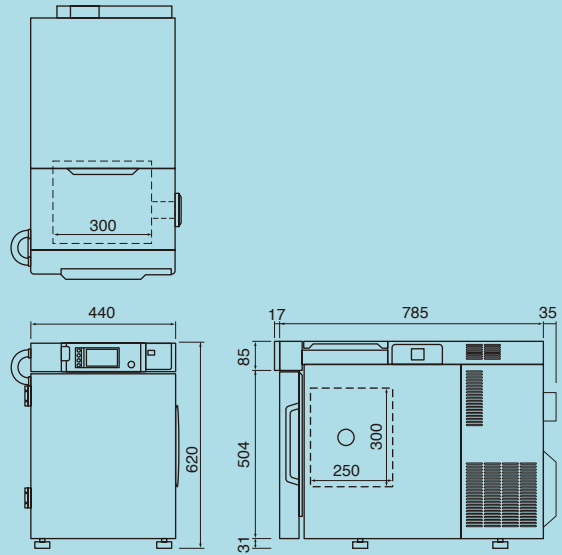

● SU-642·662

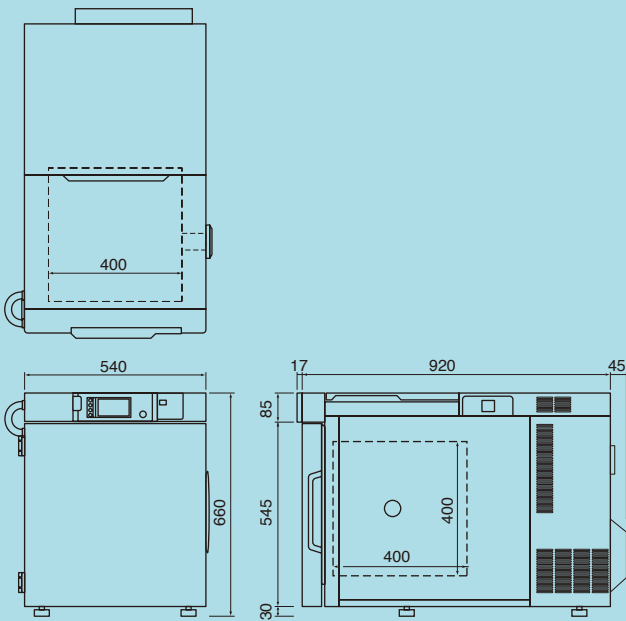

MODEL

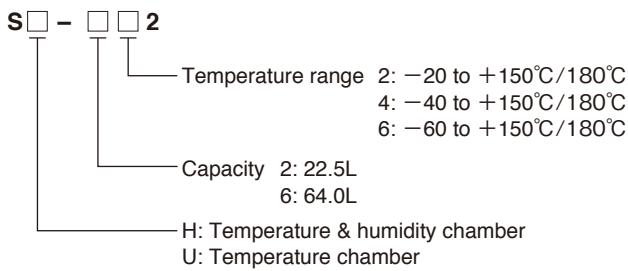

SAFETY DEVICES

- Control circuit overcurrent protection (except SH/SU-222, 242)
- Cartridge fuse for control circuit short-circuit protection
- System error (Error)
- Room temperature compensation burnout detection circuit
- Dry bulb temperature burnout detection circuit
- Absolute upper/lower temperature limit alarm (w/ built-in T/H controller)
- Expansion analog board sensor burnout detection circuit (SH/SU-242-5 only)
- Temperature switch for air circulator
- Thermal fuse
- Temperature switch for condenser fan
- Overheat protector
- Wet bulb temperature burnout detection circuit (SH only)
- Refrigerator-1 error detection
- Refrigerator-2 error detection (except SH/SU-222, 242)
- Humidifier dry heat protector (SH only)
- Humidifier water level detection (SH only)
- Temperature upper limit deviation alarm (w/ built-in T/H controller)
- Absolute upper/lower humidity limit alarm (SH only) (w/ built-in T/H controller)
- System error (Alarm)
- Water tank drought switch (SH only)
- Chamber door switch
- Water tank low-level switch (SH only)
- Specimen power supply control terminal

FITTINGS

- Temperature (Humidity) recorder terminal
- Specimen power supply control terminal
- Alarm output terminal
- External output terminal
- Cable port (φ 50 mm × 1)
- Power cable
- Water supply tank (SH only)
- Humidifying tray drain plug (SH only)
- Drain hose
- Drain socket for water sensor box (SH only)
- Ethernet port (LAN)
- USBmemory port
- Instrumentation interlock output terminal
- Instrumentation interlock input terminal

ACCESSORIES

- Shelf (Stainless steel)
Load capacity (evenly distributed)
SH/SU-222, 242, 262, 242-5 0.5kg
SH/SU-642, 662 5kg
Max. number of shelves
SH/SU-222, 242, 262, 242-5 5 stages (pitch 35mm)
SH/SU-642, 662 5 stages (pitch 50mm)
- Connector (For temperature/humidity recorder terminals)
SH: 2/ SU: 1
- Cable port plug (rubber) 1 (φ 50 mm)
- Cartridge fuse
SH/SU-222, 242, 262 (B type, 250V 7A) 1
SH/SU-642, 662, 242-5 (B type, 250V 7A, 6A) 1 of each
- Socket adapter
(100V, 115V 222, 242, 262 models only)
- Wet-bulb wick 1 box (SH only)
- Humidifying tray drain hose 2m 1 (SH only)
- Drain hose for water sensor box (0.3m) 1
- Operation manual 1 set



Safety precautions

- Do not use specimens which are explosive or inflammable, or which contain such substances. To do so could be hazardous, as this may lead to fire or explosion.
- Do not place corrosive materials in the chamber. If corrosive substances or liquid is used, the life of the unit may be significantly shortened specifically because of the corrosion of stainless steel, resin and silicone materials.
- Do not place life forms or substances that exceed allowable heat generation.
- Be sure to read the user's manual before operation.

OPTIONS

Continuous water supply



Equips the chamber with a connection for water supply system. There are 2 types available:

- Connection port with pressure-reducing valve
- Connection port without pressure-reducing valve

Roof top water tank

An additional tank that supplements the volume of the standard cartridge tank is provided to carry out continuous operation.

Effective water volume: 5L

Location: Chamber ceiling

* The connection port without pressure-reducing valve is required when selecting this option.

Automatic water refill

Automatically refill water to the humidifying tray and the wick pan periodically.

Wet-bulb wick

Same as the standard accessory.

1 box (24 wicks, 1 dropper)



Power plug

Power plug for China.

3 cores/ round type

Viewing window



64L type

Effective view:

22.5L type: W215×H215 mm

64L type: W215×H315 mm

* Standard performance may not be met under certain conditions. Inquire for details.

[Example]

- SH/SU-242 Temp. extreme achievement time (Pull down time)
From +20 to -35°C (Setting: -40°C)
Within 60 min.
- SH/SU-242-5 Temp. rate of change (Heat up rate)
From -21 to +131°C 4.0°C/min.
(Pull down rate)
From +131 to -21°C 4.0°C/min.

Roof top viewing window

Effective view: W181×D107 mm

* Not available on SH/SU-242-5

* Standard performance may not be met under certain conditions. Inquire for details.

[Example]

- SH/SU-242 Temp. extreme achievement time (Pull down time)
From +20 to -35°C (Setting: -40°C)
Within 60 min.



SH-242

Inner glass door

A glass door is provided between the test area and the chamber door to observe specimens. The glass door is equipped with a wiper for models with humidity.

* Standard performance may not be met under certain conditions. Inquire for details.

[Example]

- SH/SU-242-5 Temp. rate of change (Heat up rate)
From -21 to +131°C 4.0°C/min.
(Pull down rate)
From +131 to -21°C 4.0°C/min.



Hand-in port

Equip the chamber with hand-in port to manipulate specimen under test.

<For inner glass door>

φ130mm ×1, at the center of the inner glass door.

<For chamber side wall>

φ130mm ×1 (select left or right side)

Any hand-in port selected comes with radial rubber seal.

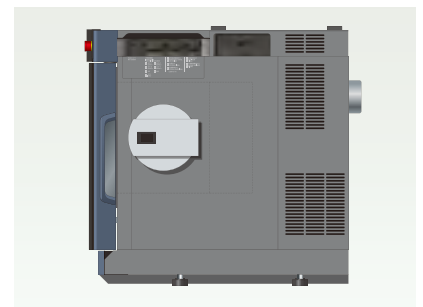

OPTIONS

Additional cable port



Provided in addition/ replacement of the standard cable port (right side, $\phi 50$ mm).

Available location:

- Left side, right side
- Ceiling

Available dimensions:

- $\phi 25$ mm
- $\phi 50$ mm
- $\phi 100$ mm
- flat cable port (W100×H25 mm)

* Comes with a rubber plug and a cap.

* Standard performance may not be met under certain conditions. Inquire for details.

Additional cable port location

<SH/SU-222·242·262·242-5>

* Top not available on SH/SU-242-5

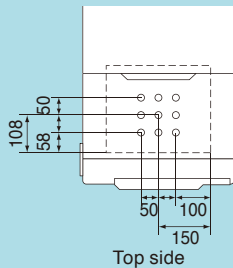

Top side

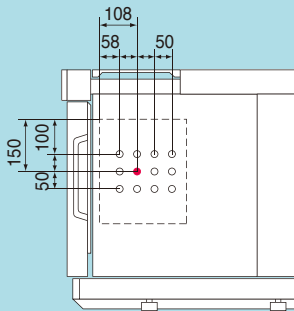

Right side

* Same location points for left side

<SH/SU-642·662>

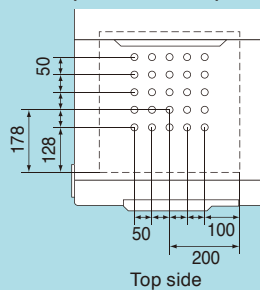

Top side

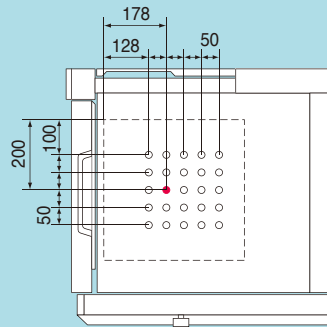

Right side

* Same location points for left side

● Standard equipped

Cable port rubber plug

Comes with the cable port.

- for $\phi 25$ mm
- for $\phi 50$ mm
- for $\phi 100$ mm
- spiral-wrapped plug (5×50×2000 mm)
- for flat cable port



for $\phi 50$ mm



for flat cable port



spiral-wrapped plug

Shelf

Same as standard shelf.

18-8 Cr-Ni Stainless steel



SH/SU-222, 242, 262, 242-5



SH/SU-642, 662

	20L type	60L type
Effective dimensions	W284 H34 D231 mm	W392 H21 D378 mm
Load capacity	0.5 kg	5 kg

Specimen basket

For small specimens that cannot be placed on the shelf.

Material: 18-8 Cr-Ni Stainless steel

Dimensions: W206×H40×D156 mm

* Place the specimen on the shelf.

* Do not use when exceeding the shelf load capacity.



OPTIONS

EZ connect cable port plug

Cable port plug w/ embedded terminals for power supply.

Cable port plug with embedded terminals (inside and outside) to ease specimen connection to an external device.

Spec.: AC 6 to 250V 0.1 to 3A
AC 1.5 to 250V 0.1 to 3A

Connector Type: Block 10P (+5P, -5P)

Enclosure: Magnetized box with isolator

Temperature Range:
-70 to +180°C 30 to 95%rh

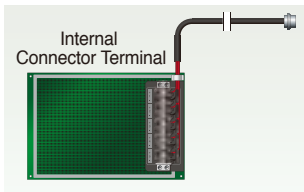
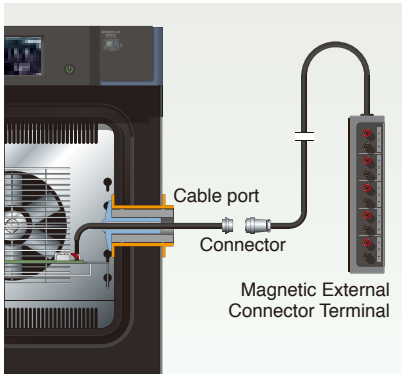

Cable organizer kit

The kit includes:

- cable ties
- magnetic cable cover
- dew tray



Noise reduction rear cover

A cover is added on the rear side of the chamber to help:

- lower further chamber noise
- direct exhaust air toward the ceiling
- store wires in order inside the cover



I/O interface



Communication ports to connect the chamber to a PC.

- RS-485
- RS-232C
- GPIB

Communication cables

- RS-485 5m/10m/30m
- RS-232C 1.5m/3m/6m
- GPIB 2m/4m

Interior web camera with terminal

We camera installed inside the test area to observe specimen, either from the controller itself, or from a computer connected with the chamber.

Components: Web camera with LED light,
Camera stand

Focal Length: Longer than 3cm

T/H range: -10 to +60°C, 30 to 95%rh



OPTIONS

Paperless recorder



Records the temperature and humidity of each section such as the temperature inside the chamber.

Sampling interval: 5 sec. (default)

Internal recording media:

Flash memory 4MB

External recording media:

CF memory card port

(Includes a 256 MB CF card)

USB memory port

< Temperature & humidity type >

No. of inputs:

Temperature 1, Humidity 1

(4 more channels can be turned ON)

< Temperature type >

No. of inputs:

Temperature 1

(5 more channels can be turned ON)

- Portable type
- Installed on the option box



Portable type

Temperature (humidity) recorder

Records the temperature and humidity of each section such as the temperature inside the chamber.

Recording method: Dot

Recording paper: Effective width 100 mm

No. of inputs:

< Temperature & humidity type >

Temperature 5, Humidity 1

SRJ12 -50 to +150°C/0 to 100% rh

SRJ14 -100 to +150°C/0 to 100% rh

SRJ15 -100 to +200°C/0 to 100% rh

< Temperature type >

Temperature 6

SRJ25 -100 to +200°C

External output terminal set (×3)

The following contact signals are installed on the option box, or stand with option box.

- Time up output terminal
Enables power supply and/or temperature measurement of the specimen synchronised with the timer.
- Time signal terminal
Add up to 10 signal terminals to the 1 equipped as standard.
- Temp. & humid. SP attainment output
Sends out a contact signal when the chamber reaches temperature (humidity) set values.

* The option box is required when selecting this option.

Wet-bulb temperature recorder output terminal

This terminal outputs the test area wet bulb temperature.

* SH type only.

Thermocouple

Attached to specimen to measure specimen temperature.

Thermocouple with a brass ball tip

Thermocouple type T (Copper/ Copper-Nickel)

- 2m
- 4 m
- 6 m



Program-synched DC power supply

Capable of applying voltage to the specimen, used for bias testing. The DC power supply unit synchronizes with constant program operations, and can be set for each temperature and humidity program step.

- 5V
- 12V
- 15V
- 24V
- 48V

* Not available on SH/SU-242-5

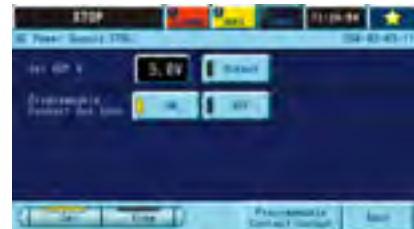

Option box

Box prepared to install additional options such as:

- Paperless recorder (stand embedded)
- External output terminal set (×3)
- Specimen temperature control
- Program-synched DC power supply

The option box can be embedded on a stand (Refer to stand configuration page 20), or standalone (for example, put on the chamber top free space, etc.)



Option box B (stand-embedded paperless recorder)

OPTIONS

Specimen temperature control



Sensors are attached to the specimen to allow exposure tests that provide temperature stress to the specimen.

- Insulated type

* Not available on SH/SU-242-5



Airflow adjuster

Used when tests require low airflow velocity or constant velocity. Setting value range: 4 levels.



Overcool protector



If the temperature inside the chamber decreases excessively, the chamber stops operating to prevent the specimens from being damaged.

External device alarm input terminal

Equips the chamber with a terminal that is used to stop operation of the chamber in the event that an external device linked to the chamber malfunctions.

Door opening signal output terminal

Equips the chamber with a terminal that outputs the door open status. Capable of controlling an external device that operates along with door operation and records the temperature disturbance history.

Emergency stop pushbutton

Stops the chamber immediately. Available with or without guard.

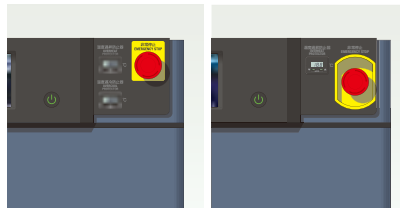

With guard

Chamber dew tray

Prevents water leaks from the chamber onto the floor.

Water leak detection system and dew tray to catch dripping water are also available to detect and prevent water damages.

Operation manual

- CD
- Booklet

Reports & certificates

- Testing and inspection report
- Test data
- Temperature (& humidity) uniformity measurement
- Calibration report
- Calibration certificate
- Traceability system chart
- Traceability certificate

Stand variation (option)

Stands equipped with casters for easy transfer or transportation. (leveling feet provided)
 Choose among 3 sizes: C (Dolly type), L (Low type) or H (High type)

Dimensions : mm For SH/SU-642-662 (For 222-242-262)

H type

The C type stand fits on the lower part.

Chamber with L stand can fit under the H stand.

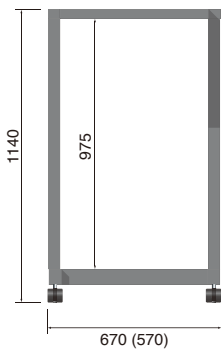

Depth : 925 (815)

• With shelf

Move the shelf to install instrumentation or measurement devices.

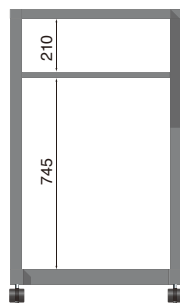

Shelf size : W577xD900 (W473xD790)

• With option box

Following options can be installed.
 • Paperless recorder
 • Output terminal set
 • Specimen temperature control
 • Program-synched DC power supply

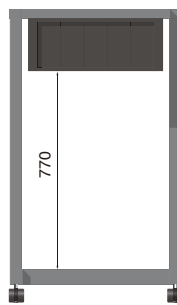

• With 19 inch rack

19 inch size instrumentation or controller can be set to the rack.

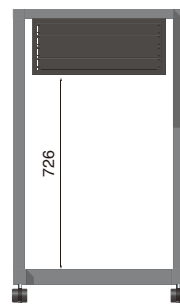

L type

• With shelf

shelf : adjustable 3 pitches

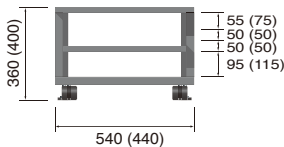

Shelf size : W480xD850 (W378xD740)
 Depth : 860 (750)

• With water tank

Capacity : 18L



* The connection port without pressure-reducing valve is required when selecting this option.

• With option box

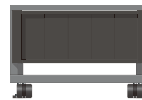

• With 19 inch rack

19 inch size instrumentation or controller can be set to the rack.



C type

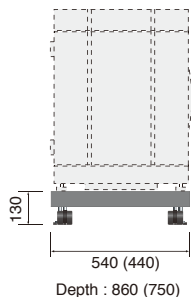

Stand configuration (example)

• H type with 19 inch rack and C type



• H type and L type with option box



* For safety reasons, make sure to secure the chamber and the stand together with anchoring fixtures. We also recommend to fix the stand itself to the floor.
 * Please inquire for 2-stage stacked chambers.

Scalability (Example)

Sub-door

Sub-door with embedded BNC connectors.

- Allow preparation of specimen beforehand. (at your desk)
- Reduce the time for specimen change.

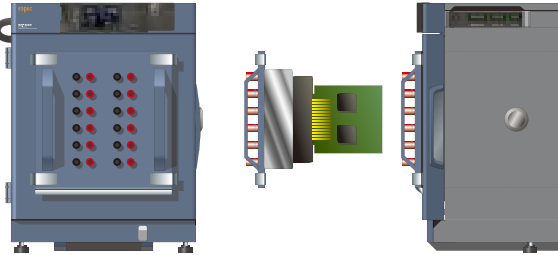

PC-less measurement system

Connect specimen for bias testing.

- Power supply for specimen in-sync with the chamber without a PC.
- Can be in-sync with temperature as well.
- Cable port plug with embedded terminals.
- Program-synched DC power supply.
- Paperless recorder.

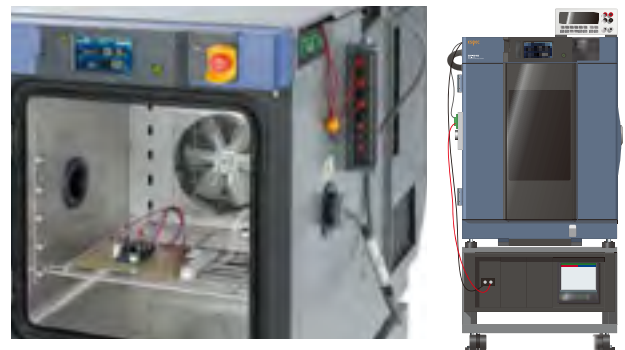

Stacked model

2-stacked chamber model

- Efficient arrangement for QA evaluation, etc., where numerous chambers are requested.
- Operation via PC or tablet, equipment networking.
- For humidity type, continuous water supply is equipped.
- Because chambers are independent, can be used for manual thermal shock testing.

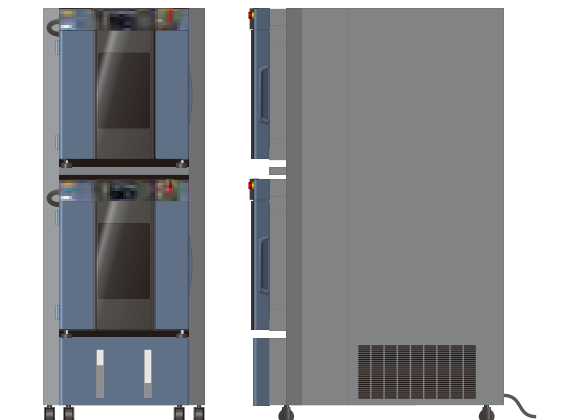

Battery charge / discharge testing

- Options prepared for battery testing, like safety doorlock, pressure relief vent, heat detector, gas detector, etc.
- All necessary features are prepared as one package for all units, offering a reduced total cost.

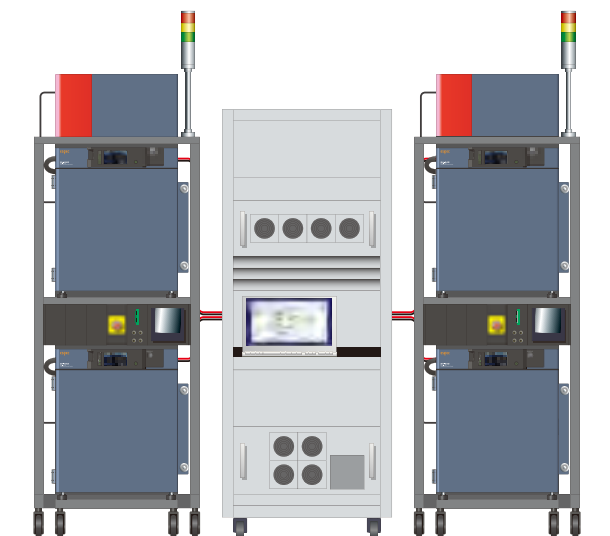

ESPEC CORP. <http://www.espec.co.jp/english>

Head Office

3-5-6, Tenjinbashi, Kita-ku, Osaka 530-8550, Japan
Tel: 81-6-6358-4741 Fax: 81-6-6358-5500

ESPEC NORTH AMERICA, INC.

Tel: 1-616-896-6100 Fax: 1-616-896-6150

ESPEC EUROPE GmbH

Tel: 49-89-1893-9630 Fax: 49-89-1893-96379

ESPEC ENVIRONMENTAL EQUIPMENT (SHANGHAI) CO., LTD.

Head Office

Tel: 86-21-51036677 Fax: 86-21-63372237

BEIJING Branch

Tel: 86-10-64627025 Fax: 86-10-64627036

TIANJIN Branch

Tel: 86-22-26210366 Fax: 86-22-26282186

GUANGZHOU Branch

Tel: 86-20-83317826 Fax: 86-20-83317825

SHENZHEN Branch

Tel: 86-755-83674422 Fax: 86-755-83674228

SUZHOU Branch

Tel: 86-512-68028890 Fax: 86-512-68028860

ESPEC TEST TECHNOLOGY (SHANGHAI) CO., LTD.

Tel: 86-21-68798008 Fax: 86-21-68798088

ESPEC SOUTH EAST ASIA SDN.BHD.

Tel: 60-3-8945-1377 Fax: 60-3-8945-1287



QMS
JIS Q 9001
JSAQ 004



MS
JAB
CM001



MS
JAB
CM021



ISO 9001/JIS Q 9001

Quality Management System Assessed and Registered

ESPEC CORP. has been assessed by and registered in the Quality Management System based on the International Standard ISO 9001:2008 (JIS Q 9001:2008) through the Japanese Standards Association (JSA).

* Registration : ESPEC CORP.
(Overseas subsidiaries not included)

ISO 14001 (JIS Q 14001)

Environmental Management System Assessed and Registered

ESPEC CORP.