

User Manual

IR IP Camera





WARNINGS

TO REDUCE THE RISK OF FIRE OR ELECTRIC SHOCK, DO NOT EXPOSE THIS PRODUCT TO RAIN OR MISTURE.

DO NOT INSERT ANY METALLIC OBJECT THROUGH VENTILATION GRILLS.

CAUTION

	CAUTION RISK OF ELECTRIC SHOCK DO NOT OPEN	
CAUTION : TO REDUCE THE RISK OF ELECTRIC SHOCK. DO NOT REMOVE COVER (OR BACK). NO USER-SERVICEABLE PARTS INSIDE. REFER SERVICING TO QUALIFIED SERVICE PERSONNEL.		

COPYRIGHT

THE TRADEMARKS MENTIONED IN THE MANUAL ARE LEGALLY REGISTERED TO THEIR RESPECTIVE COMPANIES.

Content

I. PREFACE	4
II. PRODUCT SPECIFICATIONS	4
III. PRODUCT INSTALLATION	6
A. MONITOR SETTING	6
B. HARDWARE INSTALLATION AND I/O PIN ASSIGNMENT	7
C. IP ASSIGNMENT	11
D. INSTALL ACTIVE X CONTROL	13
IV. LIVE VIDEO	15
V. CONFIGURATION	17
A. SYSTEM	18
B. NETWORK	21
C. A/V SETTING	28
D. EVENT LIST	34
VI. NETWORK CONFIGURATION	38
VII. PACKAGE CONTENTS	39
APPENDIX I	39

V1.0_100930

I. Preface

IR IP CAMERA is a professional CCD IP camera. It has built-in web server which enables user to view real-time video via IE browser. It also supports simultaneously H.264, MPEG-4&JPEG video compression and dual streaming which provides smooth and high video quality. The video can be stored in the SD card, and can be playback remotely.

IR IP CAMERA is an easy-to-use IP Camera which is designed for security application.

II. Product Specifications

- Video Out
- High Definition Resolution at 30FPS support(720P)
- IP66
- External Vari-focal lens adjustment
- True Day/Night Function
- Mechanism IR Cut Filter Available
- Fan Built-in
- IR Distance: 40/30 Meter
- H.264/ JPEG/ MPEG4 compression
- Support Cell Phone/PDA/3GPP
- Triple streaming
- SDK for Software Integration
- Free Bundle 36 ch recording software

Specifications

Hardware	
CPU	ARM 9 ,32 bit RISC
Memory	256MB
Flash	16MB
Sensor	1/3" CMOS(2M-Pixel)
Sensitivity	0 Lux(IR on)

Lens	30M/40M: Vari-Focal Auto Iris 3.6~16mm
Fan	Always On
ICR	Yes
LED	56 Unit 5φ 850nm infrared LED, 10000hrs (40M) 42 Unit 5φ 850nm infrared LED, 10000hrs (30M)
IR DISTANCE	40M/30M
I/O	1 in/ 1out(Relay Out)
Video Out	1
Power Consumption	DC 12V
Water Resistance	IP66
Dimensions	114mm(φ) x 260mm(D) (With Shield) 99.4mm(φ) x 225mm(D) (Without Shield)
Network	
Ethernet	10/ 100 Base-T
Network Protocol	HTTP, UDP,TCP/ IP, SMTP, FTP, PPPoE, DHCP, DDNS, NTP
Wireless (Optional)	
Wireless	802.11b/g
Security	WEP,WPA-PSK,WPA2-PSK
System	
Video Resolution	1600x1200, 1280x1024, 1280x960,1280x720, 800x600,640x480, 320x240, 176x144
Video adjust	Brightness, Contrast, Sharpness,BLC,Night Mode
Triple Streaming	Yes
Image snapshot	Yes
Full screen monitoring	Yes
Privacy Mask	Yes
Compression format	H.264/JPEG/MPEG4(3GPP only)
Video bitrate adjust	CBR, VBR
Motion Detection	Yes, 3 different areas
Triggered action	Mail, FTP, Relay
Pre/ Post alarm	Yes, configurable
Security	Password protection

Firmware upgrade	HTTP mode, can be upgraded remotely
Simultaneous connection	Up to 10
Web browsing requirement	
OS	Windows 2000, XP, 2003, Microsoft IE 6.0 or above
Hardware	
Suggested	Intel Dual Core 1.66G, RAM: 1024MB, Graphic card: 128MB
Minimum	Intel-C 1.6G, RAM: 256MB, Graphic card: 32MB

*SPECIFICATIONS ARE SUBJECT TO CHANGE WITHOUT NOTICE.

III. Product Installation

A. Monitor Setting

- i. Right-Click on the desktop. Select “ Properties”



- ii. Change color quality to highest (32bit).

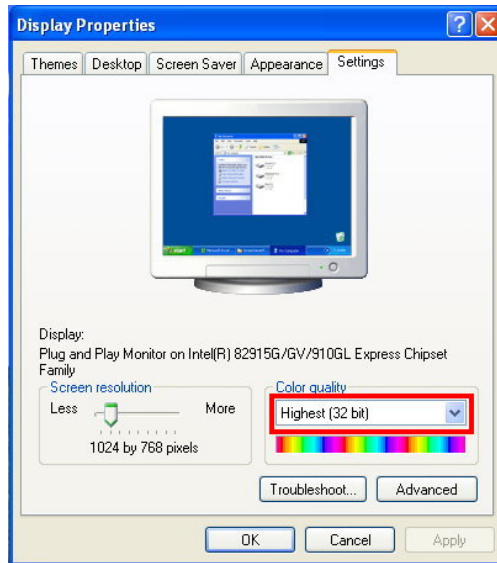

B. Hardware Installation and I/O Pin Assignment

- i. Connect a power adapter and IP Camera to PC or local network

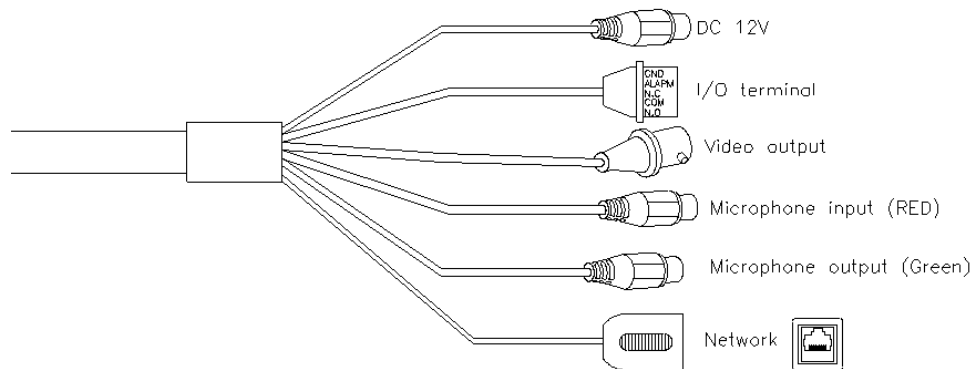

ii. I/O Control Instruction

I/O terminal connector – used in application, for e.g., motion detection, event triggering, alarm notifications. It provides the interface to:

1 Digital Input (GND+Alarm) – An alarm input for connecting devices that can toggle between an open and closed circuit, for example: PIRs, door/window contacts, glass break detectors, etc. When a signal is received the state changes and the input becomes active.

Relay output (COM +N.O.) / (COM+N.C.) – An output to Relay switch, for example: LEDs, Sirens, etc

iii. Digital Input

Alarm Input

1. GND (Ground) : Initial state is LOW
2. Alarm : Max. 50mA, DC 3.3V

Relay Output

1. N.C. (Normally Close): Max. 1A, 24VDC or 0.5A, 125VAC
2. COM: (Common)
3. N.O. (Normally Open): Max. 1A, 24VDC or 0.5A, 125VAC

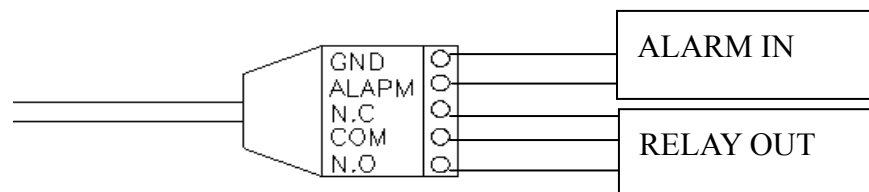

- iv. Relay
 - 1. Digital Input connection

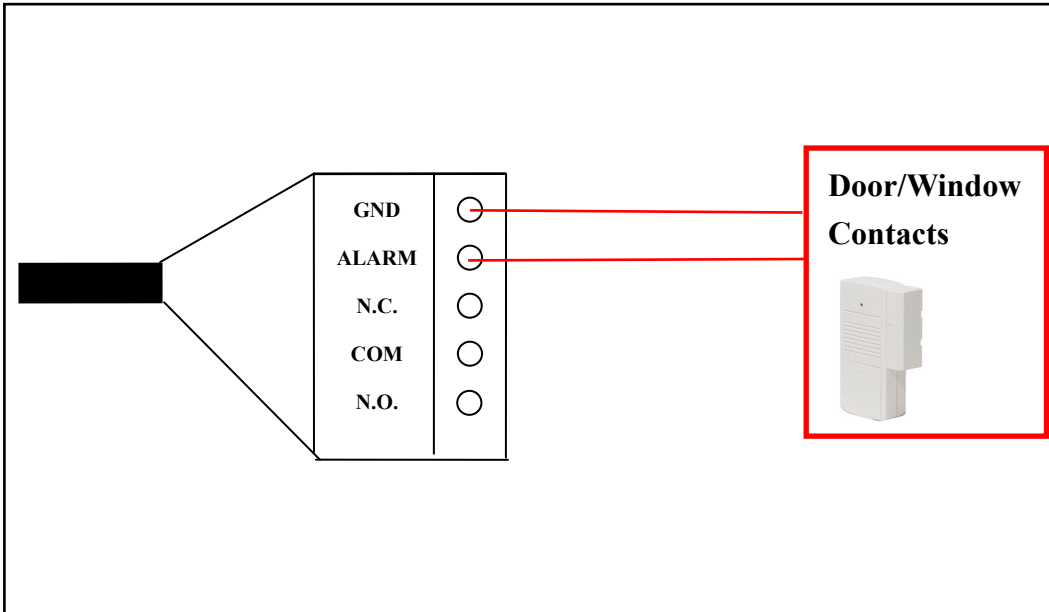

2. Relay Output Connection

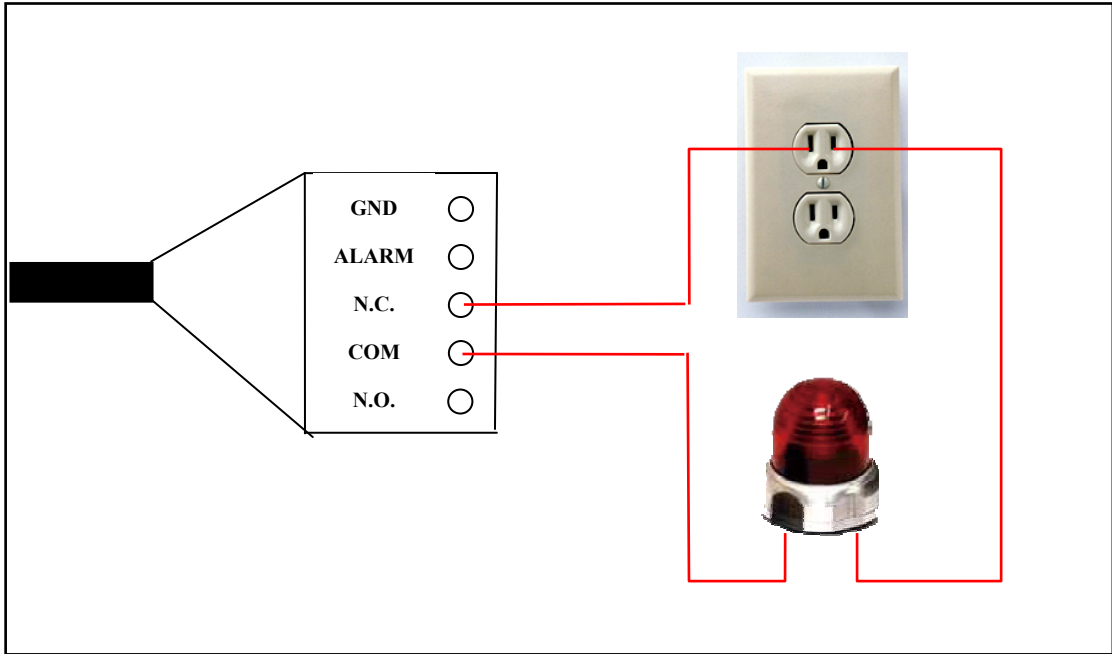

Or

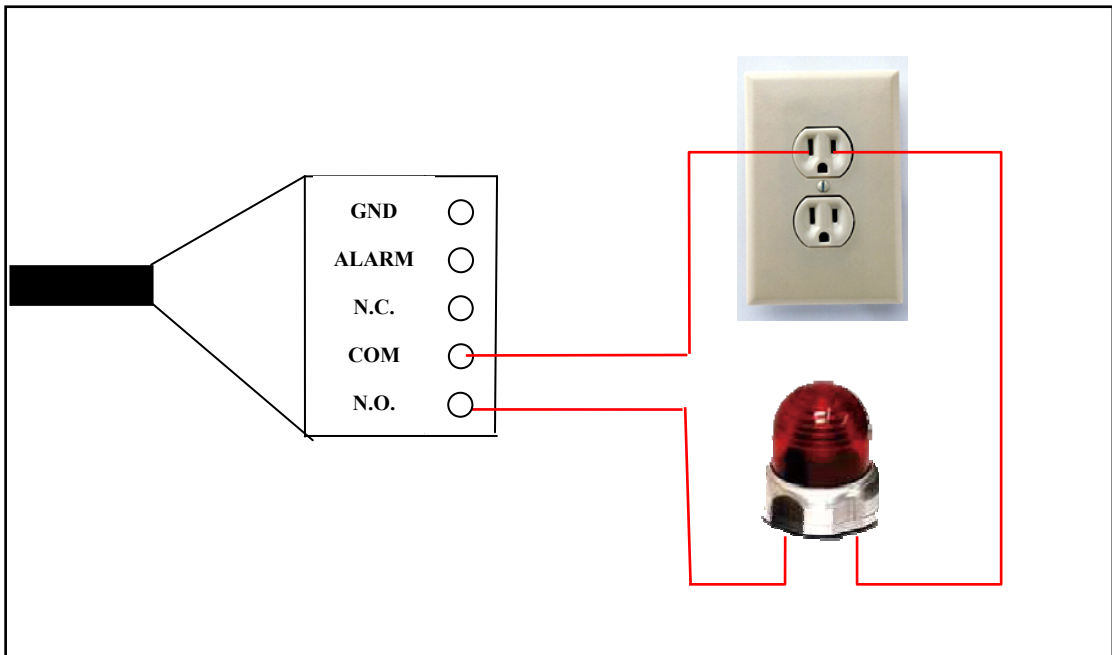

C. IP Assignment

- i. Use the software, “IP Installer” to assign the IP address of IP CAMERA. The software is in the attached software CD.
- ii. IP installer supports two languages
 - a. IPInstallerCht.exe : Chinese version
 - b. IPInstallerEng.exe : English version
- iii. There are 3 kinds of IP configuration.
 - a. Fixed IP (Public IP or Virtual IP)
 - b. DHCP (Dynamic IP)
 - c. Dial-up (PPPoE)
- iv. Execute IP Installer
- v. For Windows XP SP2 user, it may popup the following message box. Please click “Unblock”.



- vi. IP Installer configuration:

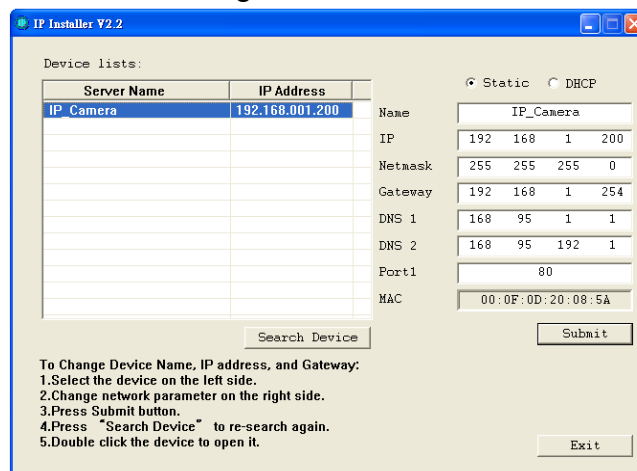

- vii. IP Installer will search all IP Cameras connected on Lan. The user can click “Search Device” to search again.

- viii. Click one of the IP Camera listed on the left side. The network configuration of this IP camera will show on the right side. You may change the “name” of the IP Camera to your preference (eg: Office, warehouse). Change the parameter and click “Submit” then click “OK”. It will apply the change and reboot the Device.

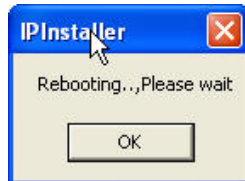

- ix. Please make sure the subnet of PC IP address and IP CAM IP address are the same.

The same Subnet:

IP CAM IP address: 192.168.1.200

PC IP address: 192.168.1.100

Different Subnets:

IP CAM IP address: 192.168.2.200

PC IP address: 192.168.1.100

To Change PC IP address:

Control Panel → Network Connections → Local Area Connection Properties → Internet Protocol (TCP/IP) → Properties

Please make sure your IP Camera and PC have the same Subnet. If not, please change IP Camera subnet or PC IP subnet accordingly.

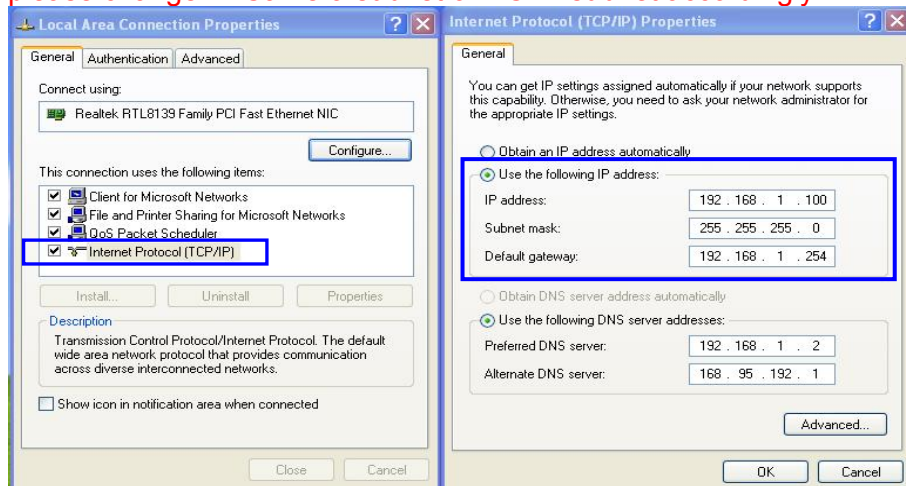

- x. A quick way to access remote monitoring is to left-click the mouse twice on a selected IP Camera listed on “Device list” of IP Installer. An IE browser will be opened.

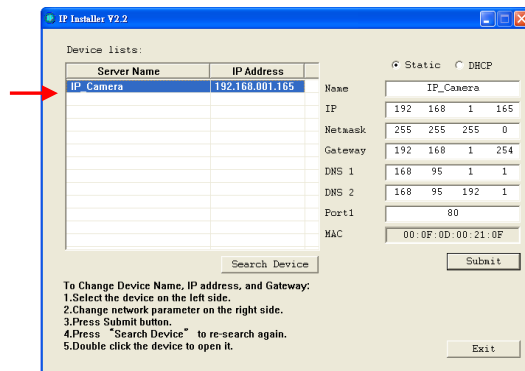

- xi. Then, please key in the default “user name: admin” and “password: admin”.



D. Install ActiveX control:

For the first time to view the camera video via IE, it will ask you to install the ActiveX component.

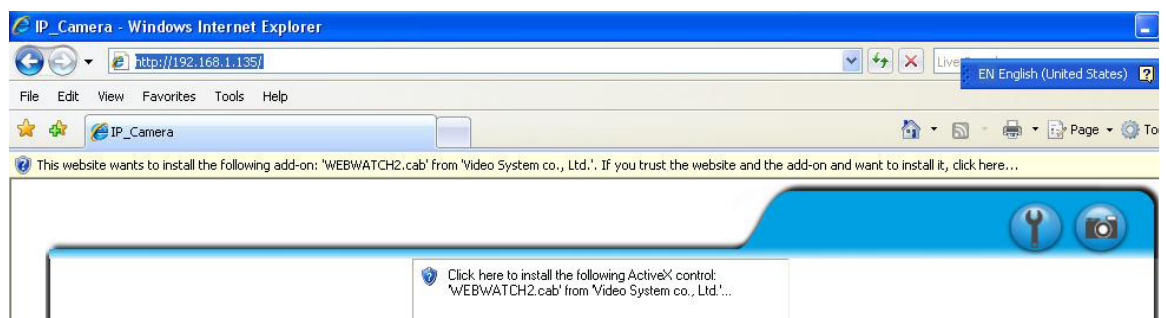

If the installation failed, please check the security setting for the IE browser.

- i. IE → Tools → Internet Options... → Security Tab → Custom Level... → Security Settings → Download unsigned ActiveX controls → Select “Enable” or Prompt.
- ii. IE → Tools → Internet Options... → Security Tab → Custom Level... → Initialize and script ActiveX controls not marked as safe → Select “Enable” or Prompt.

1

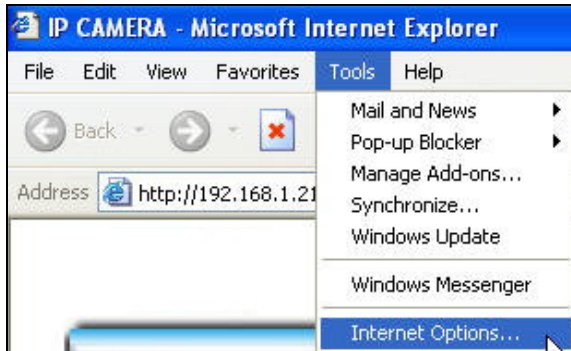

2

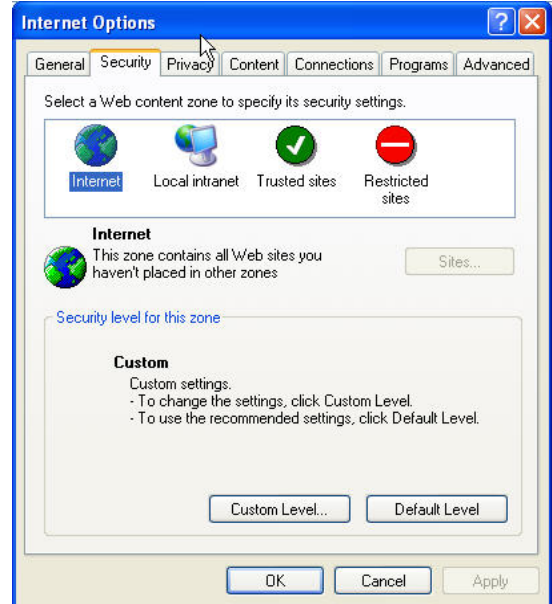

3

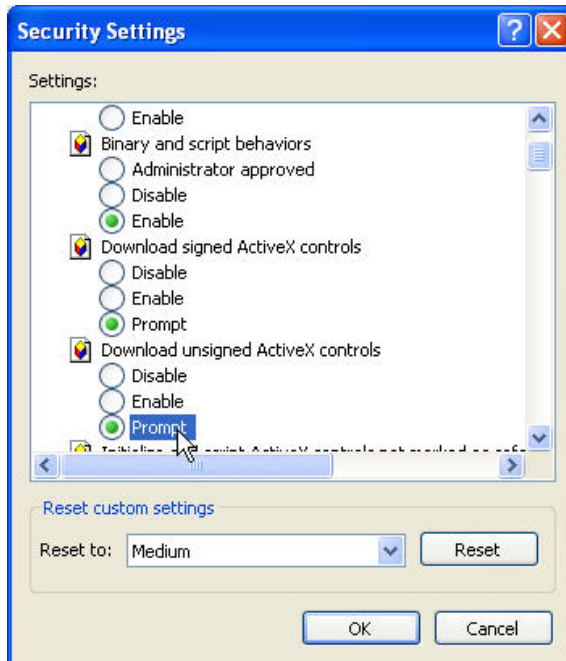

4

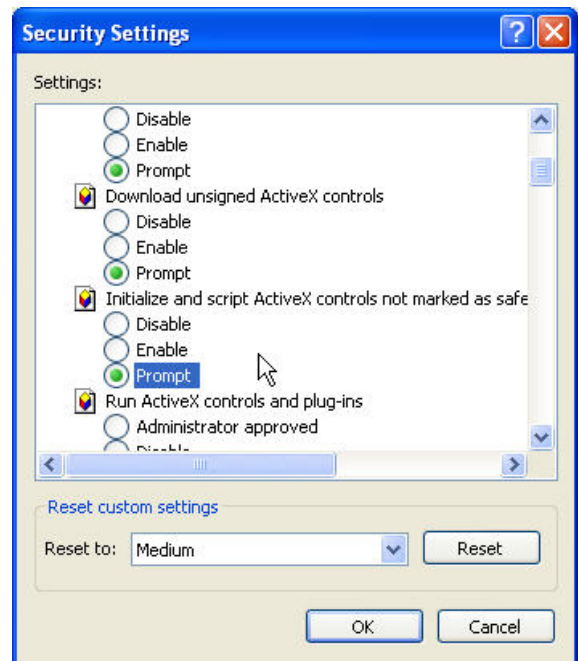

5

When popup the following dialogue box, click "Yes".

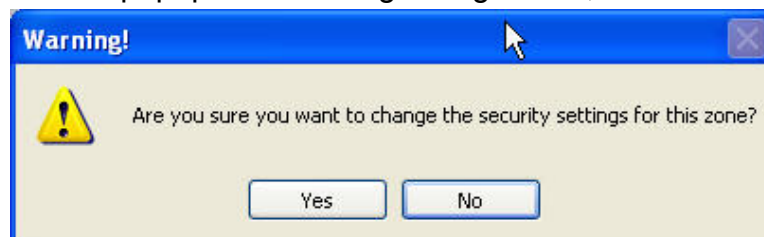

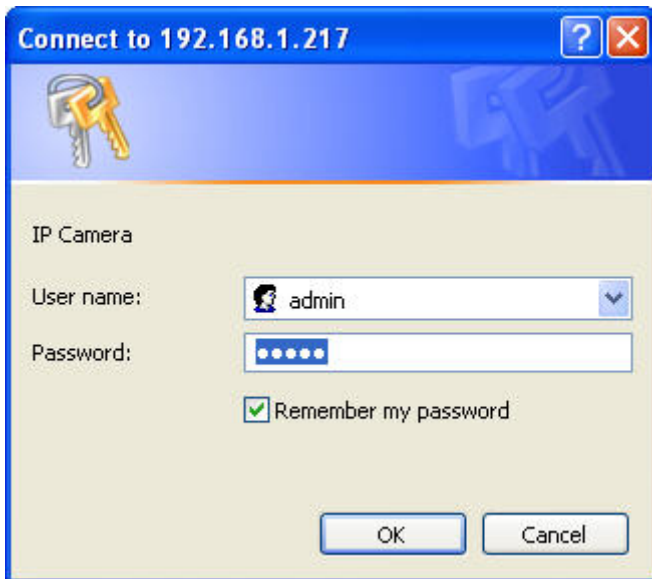

IV. Live Video

Start a IE browser, type the IP address of the IP camera in the address field. It will show the following dialogue box. Key-in the user name and password. The default user name and password are “**admin**” and “**admin**”.

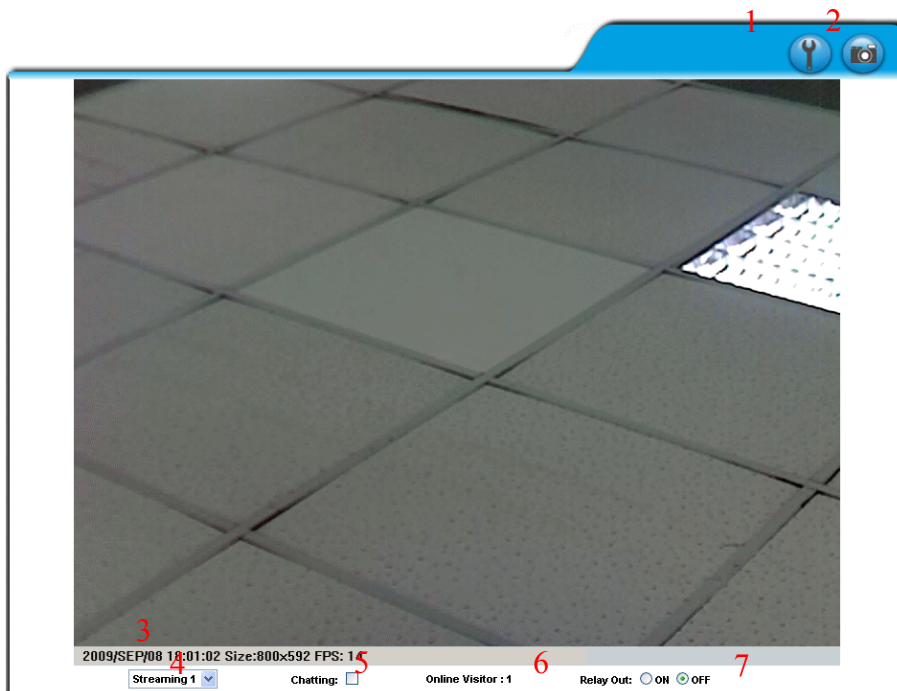

When connect to the IP CAMERA ◦ The following program interface shows.



1.  : Get into the administration page

2.  : Video Snapshot

3. Show system time, video resolution, and video refreshing rate

4. Select video streaming source **(When streaming 2 setting in 『Video Setting』 is closed, this function will not display)**

5. IP Camera supports 2-way audio. Click the “Chatting” check box. Then you can use microphone which connects to the PC to talk to server side, which is IP Camera side

6. Shows how many people connect to this IP camera

7. Control the relay which is connected to this camera.

Double-click the video, it will change to full screen mode. Press “Esc” or double-click the video again, it will change back to normal mode.

Right-Click the mouse on the video, it will show a pop-up menu.



1. Snapshot : Save a JPEG picture

2. Record Start : Record the video in the local PC. It will ask you where to save the video. To stop recording, right-click the mouse again. Select “Record Stop”. The video format is AVI. Use Microsoft Media Player to play the recorded file.

3. Mute : Turn of the audio. Click again to turn on it.

4. Full Screen : Full-screen mode.

5. ZOOM: Enable zoom-in and zoom-out functions. Select “Enable digital zoom” option first within the pop-up dialogue box and then drag and drop the bar to adjust the zoom factors.

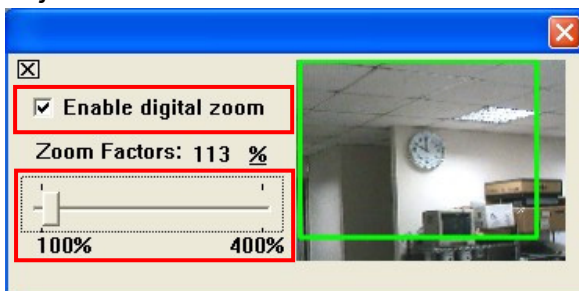

V. Configuration



Click  to get into the administration page. Click



to go back to the live video page.

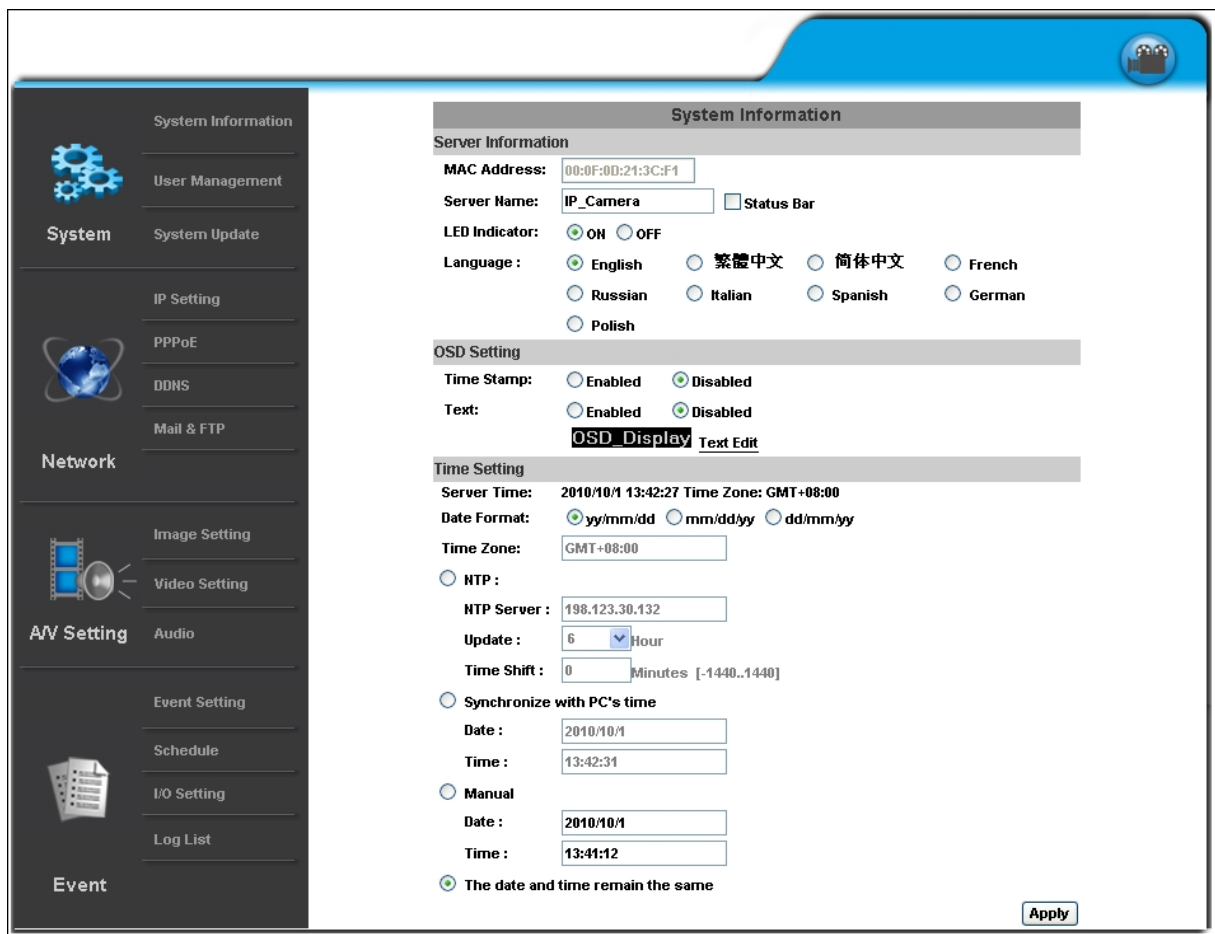

The screenshot shows the configuration page for an IP camera. On the left is a navigation menu with categories: System, Network, A/V Setting, and Event. The main content area is titled 'System Information' and contains several sections:

- Server Information:**
 - MAC Address: 00:0F:0D:21:3C:F1
 - Server Name: IP_Camera Status Bar
 - LED Indicator: ON OFF
 - Language: English 繁體中文 简体中文 French Russian Italian Spanish German Polish
- OSD Setting:**
 - Time Stamp: Enabled Disabled
 - Text: Enabled Disabled
 - OSD Display**
- Time Setting:**
 - Server Time: 2010/10/1 13:42:27 Time Zone: GMT+08:00
 - Date Format: yy/mm/dd mm/dd/yy dd/mm/yy
 - Time Zone: GMT+08:00
 - NTP:
 - NTP Server: 198.123.30.132
 - Update: 6 Hour
 - Time Shift: 0 Minutes [-1440..1440]
 - Synchronize with PC's time
 - Date: 2010/10/1
 - Time: 13:42:31
 - Manual
 - Date: 2010/10/1
 - Time: 13:41:12
 - The date and time remain the same

An **Apply** button is located at the bottom right of the configuration area.

A. System

i. System Information

- a. Server Information: Set up the camera name, select language, and set up the camera time.
 1. Server Name : This is the Camera name. This name will show on the IP Installer.
 2. Select language : There are English, Traditional Chinese, and Simplified Chinese to select. When change, it will show the following dialogue box for the confirmation of changing language.



- b. OSD Setting: Select a position where date & time stamp / text showing on screen.

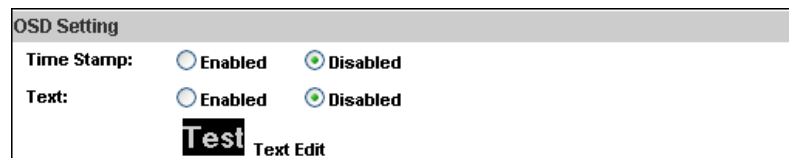

Moreover, click Text Edit can entry to adjust the OSD contents which is including Size and Alpha of text. Finally, click **Upgrade** button to reserve the setting.

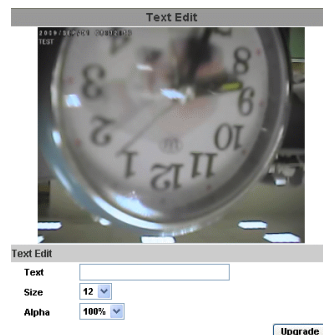

- c. Server time setting : Select options to set up time - “NTP”, “Synchronize with PC’s time”, “Manual”, “The date and time remain the same”.

Time Setting

Server Time: 2007/4/11 14:56:01 Time Zone: GMT+08:00

Date Format: yy/mm/dd mm/dd/yy dd/mm/yy

Time zone: GMT+08:00

NTP :
 NTP Server : GMT-09:00
 GMT-08:00
 GMT-07:00
 GMT-06:00
 GMT-05:00
 GMT-04:00
 GMT-03:30
 GMT-03:00
 GMT-02:00
 GMT-01:00
 GMT-00:00
 GMT+01:00
 GMT+02:00
 GMT+03:00
 GMT+03:30
 GMT+04:00
 GMT+04:30
 GMT+05:00

Synchronize
 Date :
 Time :

Manual
 Date :
 Time :

The date and time are the same

ii . User Management

IP CAMERA supports three different users, administrator, general user, and anonymous user.

User Management

Anonymous User Login

YES NO

Add User

Username:

Password:

Confirm:

User List

Username	User Group	Modify	Remove
admin	Administrator	Edit	

- a. Anonymous User Login :
 Yes : Allow anonymous login
 No : Need user name & password to access this IP camera
- b. Add user :
 Type the user name and password, then click "Add/Set".
- c. Click "edit" or "delete" to modify the user.



iii、System update :

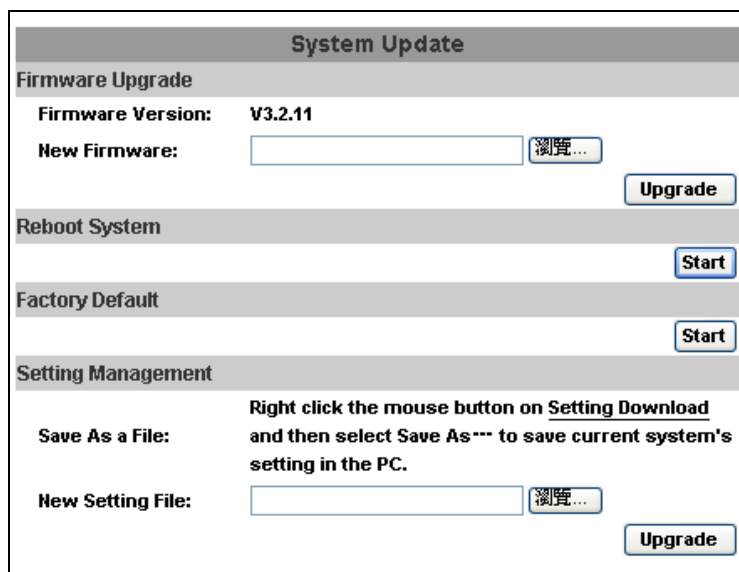

- a. To update the firmware online, click “Browse...” to select the firmware. Then click “Upgrade” to proceed.
- b. Reboot system : re-start the IP camera
- c. Factory default : delete all the settings in this IP camera.
- d. Setting Management : User may download the current setting to PC, or upgrade from previous saved setting.
 1. Setting download:

Right-click the mouse button on Setting Download → Select “Save AS...” to save current IP CAM setting in PC → Select saving directory → Save
 2. Upgrade from previous setting

Browse → search previous setting → open → upgrade → Setting update confirm → click [index.html](#). to return to main page

B.Network

i. IP Setting

IP Camera supports DHCP and static IP.

IP Setting	
IP Assignment	
<input type="radio"/> DHCP	
<input checked="" type="radio"/> Static	
IP Address:	<input type="text" value="192.168.1.200"/>
Subnet Mask:	<input type="text" value="255.255.255.0"/>
Gateway:	<input type="text" value="192.168.1.254"/>
DNS 0:	<input type="text" value="168.95.1.1"/>
DNS 1:	<input type="text" value="168.95.192.1"/>
Port Assignment	
Web Page Port:	<input type="text" value="80"/>
RTSP Port :	<input type="text" value="554"/>
RTP Start Port:	<input type="text" value="5000"/> [1024..10000]
RTP End port:	<input type="text" value="9000"/> [1025..10000]
UPnP	
UPnP:	<input checked="" type="radio"/> Enabled <input type="radio"/> Disabled
<input type="button" value="Apply"/>	

- a. DHCP : Using DHCP, IP Camera will get all the network parameters automatically.
- b. Static IP : Please type in IP address, subnet mask, gateway, and DNS manually.
- c. Port Assignment: user may need to assign different port to avoid conflict when setting up IP assignment.
 1. Web Page Port: setup web page connecting port and video transmitting port (Default: 80)
 2. RTSP Port: setup port for RTSP transmitting (Default: 554)
 3. RTP Start and End Port: in RTSP mode, you may use TCP and UDP for connecting. TCP connection uses RTSP Port (554). UDP connection uses RTP Start and End Port.

d. UPnP

This IP camera supports UPnP, If this service is enabled on your computer, the camera will automatically be detected and a new icon will be added to “My Network Places.”

Note: UPnP must be enabled on your computer.

Please follow the procedure to activate UPnP

1. open the Control Panel from the Start Menu
2. select Add/Remove Programs
3. Select Add/Remove Windows Components and open Networking Services section
4. Click Details and select UPnP to setup the service
5. The IP device icon will be added to “MY Network Places”
6. User may double click the IP device icon to access IE browser

ii \ PPPoE :

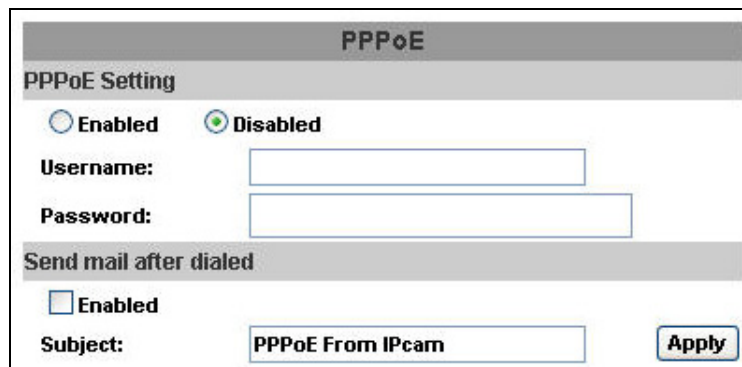

Select “Enabled” to use PPPoE.

Key-in Username and password for the ADSL connection.

Send mail after dialed : When connect to the internet, it will send a mail to a specific mail account. For the mail setting, please refer to “Mail and FTP” settings.

iii \ DDNS :

It supports DDNS (Dynamic DNS) service.

a. DynDNS :

DDNS

DDNS Setting

Enabled Disabled

Provider:

Hostname:

Username:

Password:

Schedule Update: Minutes

State

Idle

Note:

1. Schedule Update: Feature of DDNS schedule update is designed for IP products which installed behind the ICS or NAT devices. Update range from every 5 (minutes) to 5000 (minutes) and 0 remain to off.
2. Please note that the hostname will be blocked by DynDNS.org if schedule update is more than once every 5 minutes to 60 minutes. In general, schedule update in every 1440 minutes is recommended.

1. Enable this service
2. Key-in the DynDNS server name, user name, and password.
3. Set up the IP Schedule update refreshing rate.
4. Click "Apply"
5. If setting up IP schedule update too frequently, the IP may be blocked. In general, schedule update every day (1440 minutes) is recommended.

b. Camddns service :

DDNS

DDNS Setting

Enabled Disabled

Provider: ▼

Username:

Schedule Update: Minutes

State

Idle

Note:

- 1. Schedule Update:** Feature of DDNS schedule update is designed for IP products which installed behind the ICS or NAT devices. Update range from every 5 (minutes) to 5000 (minutes) and 0 remain to off.
- 2. Please note that the hostname will be blocked by DynDNS.org if schedule update is more than once every 5 minutes to 60 minutes. In general, schedule update in every 1440 minutes is recommended.**

1. Please enable this service
2. Key-in user name.
3. IP Schedule update is default at 5 minutes
4. Click "Apply".

c. DDNS Status

1. Updating : Information update
2. Idle : Stop service
3. DDNS registration successful, can now log by
<http://<username>.ddns.camddns.com> : Register successfully.
4. Update Failed, the name is already registered : The user name has already been used. Please change it.
5. Update Failed, please check your internet connection : Network connection failed.
6. Update Failed, please check the account information you provide : The server, user name, and password may be wrong.

iv 、 Mail & FTP

To send out the video via mail of ftp, please set up the configuration first.

Mail & FTP

Mail Setting

Mail Server:

Username:

Password:

Sender's Mail:

Receiver's Mail:

Bcc Mail:

FTP Setting

FTP Server:

Username:

Password:

Port:

Path:

v · Wireless Setting (Wireless Network Optional)

Supports 802.11 b/g wireless connection.

Notice : Wireless network and Ethernet network use the same IP, the user has to unplug Ethernet cable, if Ethernet cable is not unplug, wireless setting can not be executed.

Wireless Setting

Status of Wireless Networks

SSID	Mode	Security	Signal strength
allan	Infrastructure	WPA	79
RHOSON	Infrastructure	WEP	16
Link	Infrastructure	OFF	16
SinoStar	Infrastructure	WEP	11
7f-2	Infrastructure	WEP	12
00160159A7FA	Infrastructure	WEP	56
RDTEST	Infrastructure	WEP	48
3Com	Infrastructure	OFF	43
Default	Infrastructure	WPA	74

Wireless Setting

MAC Address: 00:16:16:16:DD:E1

Mode:

Operation Mode:

SSID:

Security:

a. Status of Wireless Networks :

scan all wireless services.

b. Wireless Setting :

1. **Mode** : There are Infrastructure and Ad-hoc. Infrastructure is for connecting with the router. Ad-hoc is for connecting with PC. There is “Channel” to select only when user uses Ad-hoc mode.

e.g. If one PC’s channel is 1, the other’s channel has to 1, too.

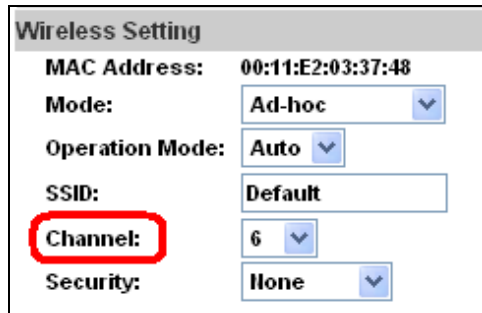

2. **SSID** : Based on AP setting.
3. **Channel** : This is only be used when the user selects Ad-hoc mode in order to avoid conflict.
4. **Security** : It supports “None”, “WEP”, “WPA-PSK” security encryption based on the setting of the Router.
5. **WEP** :

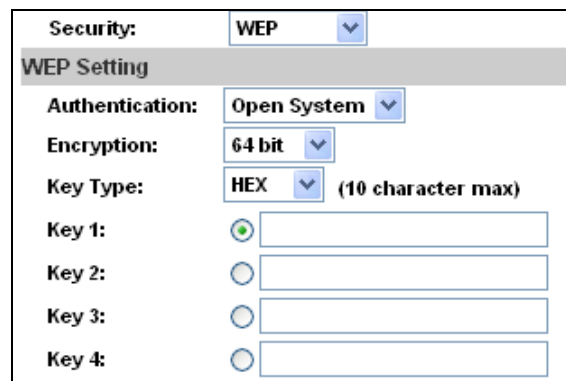

- Authentication : There are Open System and Shared Keys, it is based on different encryptions. This has to be the same as the Router’s setting.
- Encryption : There are 64 bits and 128 bits. This is based on Key Type based on the Router’s setting.
- Key Type : There are HEX and ASCII. When selecting HEX, the user only can input 0~9 characters and use A, B, C, D, E, and F.
- When selecting ASCII, the user can input any character.

(Case sensitive)

- Key 1~4 : Based on Key Type to input characters.

6. **WPA-PSK :**

Security:	WPA-PSK	▼
WPA-PSK Setting		
Encryption	TKIP	▼
Pre-Shared Key:	<input type="text"/>	(ASCII format, 8-63)

- Encryption : There are TKIP and AES.
- Pre-Shared Key : Allow any characters .(Case sensitive)

C. A/V Setting

i. Image Setting



The screenshot shows the 'Image Setting' interface of an IP camera. At the top is a 'Camera' preview window. Below it is a 'Privacy Mask' section with three colored buttons: 'Area 1' (blue), 'Area 2' (green), and 'Area 3' (red), along with a 'Save' button. The 'Image Setting' section includes: 'Brightness' (0), 'Contrast' (0), and 'Sharpness' (0), each with a dropdown arrow; 'BLC' with 'ON' and 'OFF' radio buttons; 'Night Mode' with a 'Max 5 frame rate' dropdown; and 'Video Orientation' with 'Flip' and 'Mirror' checkboxes. A 'Default' button is located at the bottom right of the settings area.

For the security purpose, there are three areas can be setup for privacy mask. Click Area button first and pull a area on the above image. Finally, click **Save** button to reserve the setting.

Adjust “Brightness”, “Contrast”, “Hue”, “Saturation” to get clear video. Moreover, IP CAMERA supports “Back Light Compensation”, “Night Mode” and “Video Orientation”.

Among CCD Setting, user can adjust other settings such as BLC Mode, Day & Night, Night Mode, and Video Orientation.

This IP camera belongs to external varifocal lens adjustment camera. Please adjust “**ZOOM**” first and “**FOCUS**” in the following to complete the adjustment.

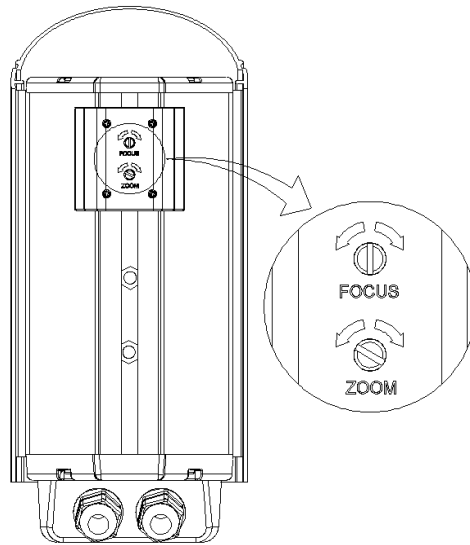

ii - Video Setting

User may select 2 streaming output simultaneously:

Streaming 1 Setting: Basic mode and Advanced mode

Streaming 2 Setting: Basic mode, Advanced mode, and 3GPP mode

(Max Video Frame Rate for both streaming combined is 30 FPS)

- a. Video System: click the drop down list to select the Input Resolution, Video System and TV Output.

Video Setting	
Input Resolution:	1600x1200 @ 15fps ▾
Video System:	NTSC ▾
TV Output:	Auto ▾ (Auto : Based on the Video System)

- b. Streaming 1 Basic Mode :

Streaming 1 Setting	
<input checked="" type="radio"/> Basic Mode	<input type="radio"/> Advanced Mode
Resolution:	800x600 ▾
Quality:	Best ▾
Video Frame Rate:	15 FPS ▾
Video Format:	H.264 ▾
RTSP Path:	<input type="text"/> ex:rtsp://</> Audio:G.711

1. Resolution :

There are 8 resolutions can be chosen.

1600x 1200, 1280x1024, 1280x960, 1280x720, 800x600, 640x480, 320x240, 176x144

2. Quality :

There are 5 levels to adjust:

Best/ High/ Standard/ Medium/ Low

The higher the quality is, the bigger the file size is. Also not good for internet transmitting

3. Video Frame Rate : The video refreshing rate per second.

4. Video Format : H.264 or JPEG

5. RTSP Path: RTSP output name

c. Streaming 1 Advanced Mode :

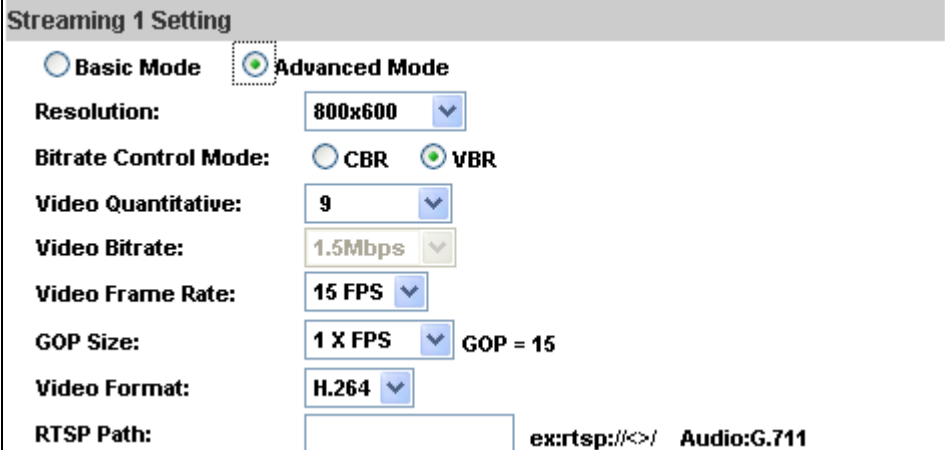

The screenshot shows the 'Streaming 1 Setting' window. At the top, there are two radio buttons: 'Basic Mode' (unselected) and 'Advanced Mode' (selected). Below this, several settings are listed with dropdown menus or radio buttons:

- Resolution:** 800x600
- Bitrate Control Mode:** CBR (unselected) and VBR (selected)
- Video Quantitative:** 9
- Video Bitrate:** 1.5Mbps
- Video Frame Rate:** 15 FPS
- GOP Size:** 1 X FPS (with 'GOP = 15' text to the right)
- Video Format:** H.264
- RTSP Path:** A text input field containing 'ex:rtsp://</>' and 'Audio:G.711'.

1. Resolution :

There are 8 resolutions can be chosen.

1600x 1200, 1280x1024, 1280x960, 1280x720, 800x600, 640x480, 320x240, 176x144

2. Bitrate Control Mode

There are CBR [Constant Bit Rate] and VBR [Variable Bit Rate] to use.

CBR : 32Kbps~4Mbps (the higher the CBR is, the better the video quality is)

VBR : 1(Low)~10(High) – Compression rate, the higher the compression rate, the lower the picture quality is; vise versa. The balance between VBR and network bandwidth will affect picture quality. Please carefully select the VBR rate to avoid picture breaking up or lagging.

3. Video Frame Rate

The video refreshing rate per second.

NTSC: Max 30 frames/second PAL: Max 25 frames/second

4. GOP Size
It means "Group of Pictures". The higher the GOP is, the better the quality is.
5. Video Format : H.264 or JPEG
6. RTSP Path: RTSP output connecting route

d. Streaming 2 Basic Mode :

Streaming 2 Setting

Basic Mode Advanced Mode

Resolution:

Quality:

Video Frame Rate:

Video Format:

RTSP Path: **ex:rtsp://</>/v2 Audio:G.711**

1. Resolution :
There are 8 resolutions can be chosen.
1600x 1200, 1280x1024, 1280x960, 1280x720, 800x600, 640x480, 320x240, 176x144
2. Quality :
There are 5 levels to adjust:
Best/ High/ Standard/ Medium/ Low
The higher the quality is, the bigger the file size is. Also not good for internet transmitting
3. Video Frame Rate : The video refreshing rate per second.
4. Video Format : H.264 or JPEG
5. RTSP Path: RTSP output connecting route

e. Streaming 2 Advanced Mode :

Streaming 2 Setting

Basic Mode Advanced Mode

Resolution:

Bitrate Control Mode: CBR VBR

Video Quantitative:

Video Bitrate:

Video Frame Rate:

GOP Size:

Video Format:

RTSP Path: **ex:rtsp://</>/v2 Audio:G.711**

1. Resolution :
There are 8 resolutions can be chosen.
1600x 1200, 1280x1024, 1280x960, 1280x720, 800x600,
640x480, 320x240, 176x144
2. Quality :
There are 5 levels to adjust:
Best/ High/ Standard/ Medium/ Low
The higher the quality is, the bigger the file size is. Also not
good for internet transmitting
3. Video Frame Rate :
The video refreshing rate per second.
4. Video Format : H.264 or JPEG
5. RTSP Path: RTSP output name

f. 3GPP Streaming mode:

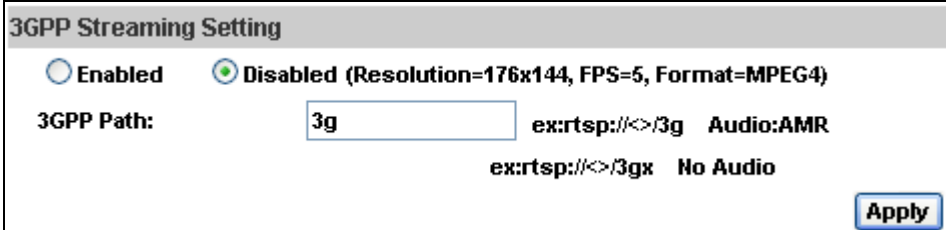

The screenshot shows a dialog box titled "3GPP Streaming Setting". It contains two radio buttons: "Enabled" (which is unselected) and "Disabled (Resolution=176x144, FPS=5, Format=MPEG4)" (which is selected). Below the radio buttons, there is a label "3GPP Path:" followed by a text input field containing "3g". To the right of the input field, there are two RTSP path examples: "ex:rtsp://</>/3g Audio:AMR" and "ex:rtsp://</>/3gx No Audio". An "Apply" button is located in the bottom right corner of the dialog box.

3GPP mode suggested setting: 176x144 resolution, 5FPS, MPEG4 format

1. Enable or Disable 3GPP Streaming
2. 3GPP: 3GPP output name

iii 、 Audio :

IP CAMERA supports 2-way audio. User can send audio from IP Camera Built-in mic to remote PC; User can also send audio from remote PC to IP Camera's external speaker.

- a. Audio from IP camera built-in mic to local PC: select "Enable" to start this function.

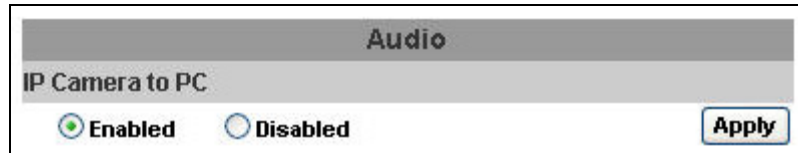

- b. Audio from local PC to IP Camera: Check "chatting" in the browsing page.

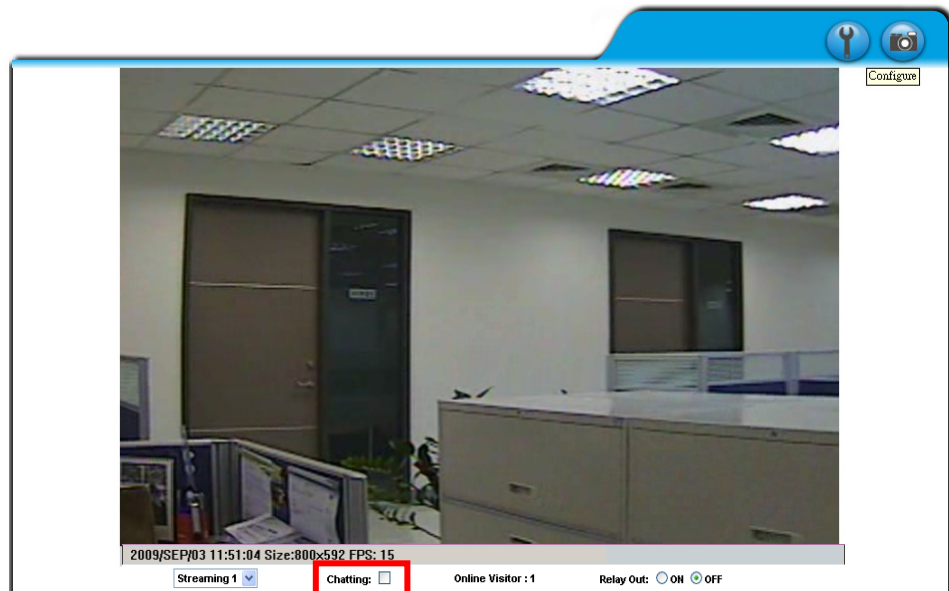

The Audio will not be smooth when enable SD card recording function simultaneously.

D.Event List

IP CAMERA provides multiple event settings.

i、 Event Setting

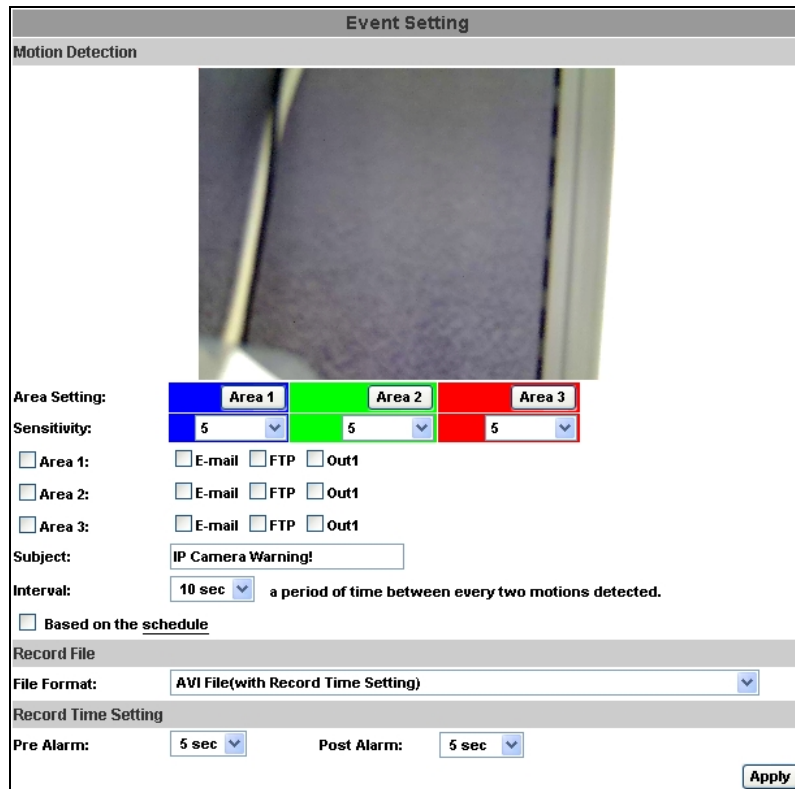

a. Motion Detection :

IP CAMERA allows 3 areas motion detection. When motion is triggered, it can send the video to some specific mail addresses, transmit the video to remote ftp server, trigger the relay, and save video to local SD card. To set up the motion area, click “Area Setting”. Using mouse to drag and draw the area. The same operation for area 2 and 3.

b. Record File Setting: IP CAMERA allows 3 different types of recording file to change its record size.

When motion/alarm is triggered, there are 3 different types of record mode.

1. AVI File (With Record File Setting)
2. Multi-JPEG (With Record File Setting), only with JPEG compression format.
3. Single JPEG (Single File with Interval Setting)

c. Record Time Setting :

Pre Alarm and Post Alarm setups for video start and end time when motion detected, I/O, or other devices got triggered.

Note: Pre/Post Alarm record time is base on record time setting and IP Cam built-in Ram memory. Limited by IP Cam built-in Ram Memory, When information is too much or video quality set too high, it will cause recording frame drop or decrease on post alarm recording time.

ii \ Schedule

- a. Schedule: After complete the schedule setup, the camera data will be recorded according to the schedule setup.
- b. Snapshot: After enable the snapshot function, user can select the storage position of snapshot file, the interval time of snapshot and the reserved file name of snapshot.

Schedule

All	0	1	2	3	4	5	6	7	8	9	10	11	12	13	14	15	16	17	18	19	20	21	22	23	
Mon.																									
Tue.																									
Wed.																									
Thu.																									
Fri.																									
Sat.																									
Sun.																									

With schedule setup.

Snapshot

Enabled Disabled

Snapshot: E-mail FTP Save to SD card

Interval: Second(s) [1..50000]

File Name:

iii \ I/O Setting

IP CAMERA supports 1 input/ 1 output. When input is triggered, it can send the video to some specific mail addresses, transmit the video to remote ftp server and trigger the relay.

I/O Setting

Input Setting

Input 1 Sensor:

Input 1 Action: E-mail FTP Out1

Subject:

Interval:

Based on the schedule

Output Setting

Mode Setting: OnOff Switch Time Switch

Interval:

CATUTION!!

Please connect to propriety relay box to reduce the risk of electric shock & damaged.

Alarm Input Setting

By GPIO I/O port input that provide related action while I/O input triggered.

GPIO Output Setting

By GPIO I/O port output that provide OnOff Switch, Slide Switch & Pan/Tilt Module for using with relay box.

GPIO pin define please refer to the part of Front / Back plane & I/O port pin assignment

GPIO 0	ALARM INPUT
GPIO 1	Normal: 3.3V (The voltage differential from GPIO pin & GND) Active: 0V (GPIO 0 & GPIO1 link to PIN2 GND)
GPIO 2	ALARM OUTPUT
GPIO 3	Normal: 3.3V (The voltage differential from GPIO pin & GND) Active: 0V (GPIO 0 & GPIO1 link to PIN2 GND)

GPIO INSTALLATION EXAMPLE 1

Trigger a normal off (Normal Open) alarm siren on when event/motion occur at COM:

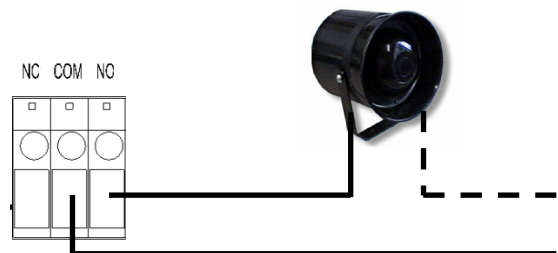

GPIO INSTALLATION EXAMPLE 2

Trigger the normal on (Normal Close) indoor illumination off when event / motion occur at COM:

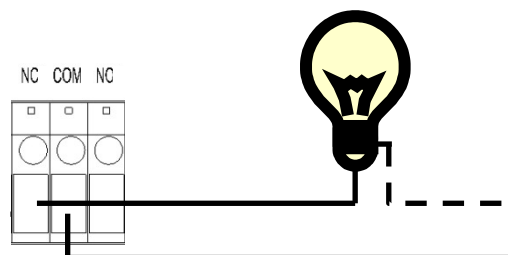

iv 、 Log List

Log List	
System Logs	Logs
Motion Detection Logs	Logs
I/O Logs	Logs
All Logs	Logs

Sort by System Logs, Motion Detection Logs and I/O Logs. In addition, System Logs and I/O Logs won't lose data due to power failure.

VI. Network Configuration

i \ Configuration 1 :

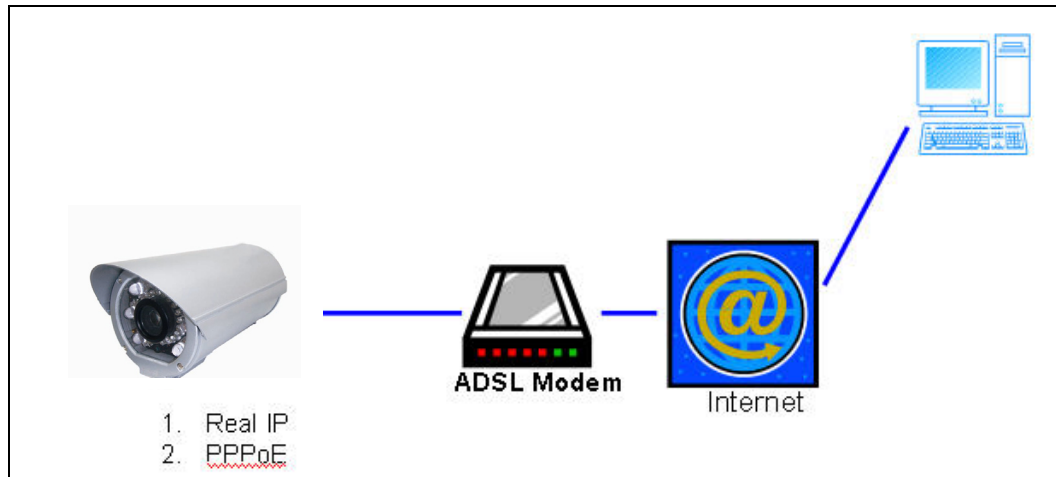

- a. Internet Access : ADSL or Cable Modem
- b. IP address : One real IP or one dynamic IP
- c. Only IP CAMERA connects to the internet
- d. For fixed real IP, set up the IP into IP CAMERA. For dynamic IP, start PPPoE.

ii \ Configuration 2 :

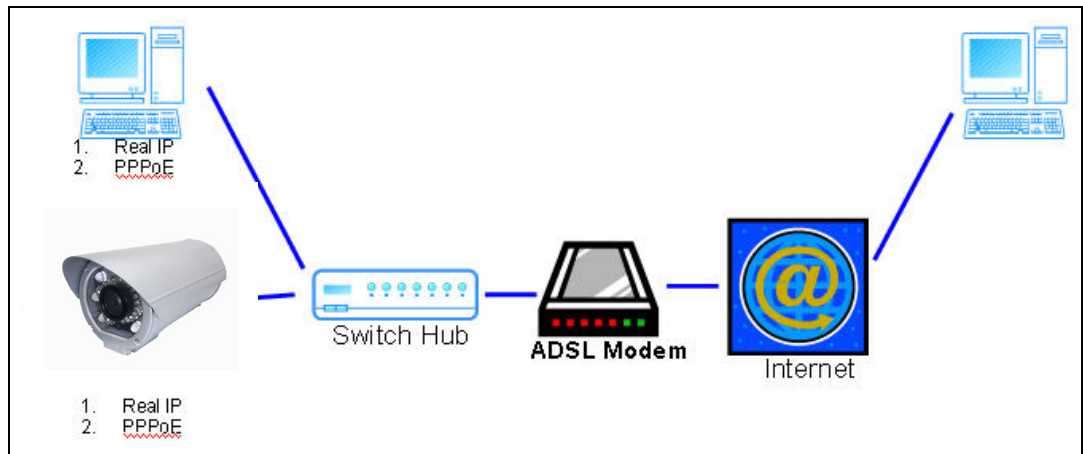

- a. Internet Access : ADSL or Cable Modem
- b. IP address : More than one real IP or one dynamic IP
- c. IP CAMERA and PC connect to the internet
- d. Device needed : Switch Hub
- e. For fixed real IP, set up the IP into IP CAMERA and PC. For dynamic IP, start PPPoE.

iii 、 Configuration 3 :

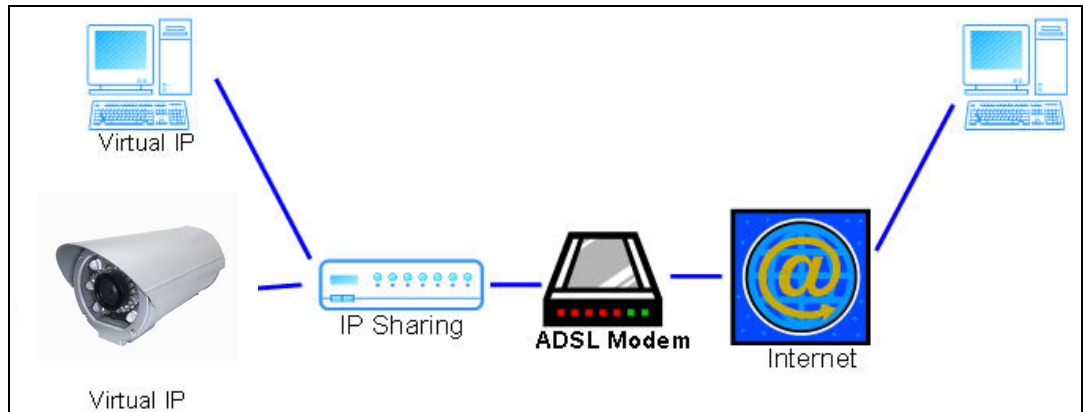

- a. Internet Access : ADSL or Cable Modem
- b. IP address : one real IP or one dynamic IP
- c. IP CAMERA and PC connect to the internet
- d. Device needed : IP sharing
- e. Use virtual IP, set up port forwarding in IP sharing.

VII. Package contents

- i 、 IP CAMERA Network Camera
- ii 、 Adaptor
- iii 、 Ethernet Cable
- iv 、 CD title (User manual, IP installation Utility)

Appendix I

SD Card Recommended :

SanDisk 128M	SanDisk 8GB
SanDisk 256M	SanDisk 16GB
SanDisk 512M	SanDisk 32GB
SanDisk 1G	Transcend 4GB
SanDisk 2G	Transcend 8GB
SanDisk 4G	Transcend 16GB
	Transcend 32GB