

# User Manual

## English

---

**MARELLI ENERGY CONTROLLER MEC-100**

**Regulation System for Three-phase Synchronous Generators**



This page is intentionally blank.



This Manual provides information about installation and operation of MEC-100 Regulation System. It deals extensively with the following subjects:

- ❖ *General information.*
- ❖ *Technical specifications.*
- ❖ *Functional description.*
- ❖ *Installation.*
- ❖ *MEC-100 Interface System.*
- ❖ *MEC-100 Interface System setting procedure.*
- ❖ *Warranty, After Sales Service and Maintenance.*

Several operations described in this manual are preceded by recommendations or symbols which alert about possible risks of accidents. It is therefore important to understand the following symbols:



Refers to operations which may cause damage to the product, accessories or to the components connected to the same. It also refers to procedures and operations which may cause serious injury or death to persons.



Refers to immediate electrical dangers which may cause the death of persons.



**WARNING:** It is not the intention of this manual to cover all installation or connection diagram variations, nor does this manual provide information for every possible contingency. Only the technical information provided by Marelli Motori's Technical Personnel can integrate this Manual. Should further information be required, please contact After Sales Department (see the following reference).



AFTER MARKET DEPARTMENT  
MARELLI MOTORI S.p.A.  
Tel: +39 0444 479 775  
Fax: +39 0444 479 757  
E-mail: [service@marellimotori.com](mailto:service@marellimotori.com)  
Web: [www.marellimotori.com](http://www.marellimotori.com)





## **PRELIMINARY INSTRUCTIONS**

The CD-ROM provided together with the MEC-100 includes the utility for the installation of the MEC-100 Interface System software, for setting and monitoring operations. The PC system has to match the following minimum requirements.

### **Minimum PC System Requirements**

Here below the minimum system requirements for the proper installation and utilization of the software are listed:

- ❖ PC IBM compatible, Intel® Pentium® II (300MHz or higher recommended).
- ❖ 128MB of RAM (256MB or more recommended).
- ❖ Microsoft Windows® OS.
- ❖ CD-ROM drive.
- ❖ RS-232 Serial port or USB port.

The provided CD-ROM includes also the MEC-100 User Manual files.



**WARNING: Before to use the MEC-100 regulation device and/or install the MEC-100 Interface System carefully read all the instructions included into the *User Manual*.**

### **User Manual Consultation**

In order to look the manual up, consider the following instructions:

- ❖ Insert the CD-ROM disk provided with the MEC-100 into the PC CD-ROM drive.
- ❖ Open the folder *Manuals* and click the manual file with the desired language.

### **Installing the MEC-100 Interface System**

To install the MEC-100 Interface System in the PC, refer to Par. 5.2.

### **Commissioning - Warnings**



**WARNING: Unless prior agreement has been made with Marelli Motori, the initial start-up of a plant with MEC-100 regulation unit MUST be always conducted by Marelli Motori personnel, strictly in accordance with the provided connection diagrams. Any amendments to such diagrams must be either made or approved by Marelli Motori.**

**Marelli Motori is under no liability for any damages which may occur to the AVR, the plant or the persons, or for lost earnings, or financial loss, or system stoppages, due to either a start-up not performed by a Marelli Motori's skilled personnel, and diagrams' modifications not carried out or previously approved by Marelli Motori itself.**



**WARNING: Before doing any operations and/or any set-up on MEC-100, is to be taken into consideration that lethal voltage is present at the top panel when the unit is energized. Top panel connections and/or operations with or without tools should be made only when the unit is de-energized.**

Should further information be required, please contact:



**AFTER MARKET DEPARTMENT**  
**MARELLI MOTORI S.p.A.**  
 Tel: +39 0444 479 775  
 Fax: +39 0444 479 757  
 E-mail: [service@marellimotori.com](mailto:service@marellimotori.com)  
 Web: [www.marellimotori.com](http://www.marellimotori.com)





## REVISION HISTORY

The following tables are the lists of hardware, firmware, software and manual revisions of the MEC-100, listed in chronological order.

### **Part Number M71FA300A**

	Version	Date	Change
<b>Hardware</b>	1 <sup>st</sup> series	07/07	Initial release
	2 <sup>nd</sup> series	09/07	Revised current sensing
	3 <sup>rd</sup> series	09/08	Revised surge suppressors
<b>Firmware</b>	1.01	07/07	Initial release
	1.02	10/07	Improvements to Underfrequency Limiter options
	1.03	08/08	Improvements to transient performances from parallel operation to single unit operation
	1.04	09/08	Decreased time delay of contact PF/VAR
	1.05	10/08	Reviewed START contact
<b>Software</b>	1.0 v5	07/07	Initial release
	1.0 v6	09/07	Added Italian and English language User Manuals
	1.0 v7	11/07	Added auxiliary input display
	1.0 v8	03/08	Revised English language version

### **Part Number M71FA310A - M71FA320A**

	Version	Date	Change
<b>Hardware</b>	3 <sup>a</sup> serie	03/09	Initial release
<b>Firmware</b>	2.00	03/09	Initial release
<b>Software</b>	3.0 v2	03/09	Initial release
	3.0 v3	08/09	Revised printing tools

### **MEC-100 Series Manuals**

	Version	Date	Change
<b>Manual</b>	Rev.0	07/07	Initial release
	Rev.1	09/08	❖ Revision 0 corrections ❖ Added user instructions of the De-excitation Contact with MEC-100
	Rev.2	11/08	Revision 1 corrections
	Rev.3	02/09	Revision 2 corrections
	Rev.4	03/09	Added Diode Monitoring Function and Field Current Regulation Mode
	Rev.5	07/09	❖ Additional installation instructions: De-excitation (Shutdown) contact use, restrictions and EMC immunity ❖ Additional instructions for UP/DOWN contacts: operating modes and restrictions ❖ Additional instructions for RESET contact for M71FA300A code





This page is intentionally blank.



# MARELLI ENERGY CONTROLLER

## USER MANUAL



Issued	Date	<b>User Manual</b> <b>MEC-100</b>		
Stefano Massignani	22/04/2009			
Checked	Date			
Stefano Massignani	23/04/2009	Document Number	Language	Pages
Approved	Date	SIN.NT.023.5	English	73
				

This page is intentionally blank.



## CONTENTS

<u>Minimum PC System Requirements</u> .....	iv
<u>Installing the MEC-100 Interface System</u> .....	iv
<b>1. GENERAL INFORMATION.....</b>	<b>7</b>
1.1. INTRODUCTION – MEC-100 SERIES .....	7
1.2. MEC-100 SERIES CHARACTERISTICS.....	7
1.2.1. Functions .....	7
1.2.2. Inputs.....	7
1.2.3. Outputs .....	8
1.2.4. Human-Machine Interface .....	8
1.3. DEVICE SELECTION .....	8
<b>2. TECHNICAL SPECIFICATIONS .....</b>	<b>9</b>
2.1. SUPPLY AND POWER .....	9
2.2. GENERATOR VOLTAGE SENSING .....	9
2.3. NETWORK VOLTAGE SENSING .....	9
2.4. GENERATOR CURRENT SENSING .....	9
2.5. ANALOGUE AUXILIARY INPUTS .....	10
2.6. EXCITER FIELD.....	10
2.7. ACCURACY .....	10
2.8. LIMITERS AND OTHER FUNCTIONS .....	10
2.9. PROTECTIONS.....	11
2.10. CONTACTS.....	11
2.11. ENVIRONMENT .....	12
2.12. PHYSICAL SPECIFICATIONS.....	12
2.13. EMC.....	12
<b>3. FUNCTIONAL DESCRIPTION.....</b>	<b>13</b>
3.1. INTRODUCTION .....	13
3.2. POWER AND CARD SUPPLY (P1-P2-P3) .....	13
3.3. OPERATING MODES .....	13
3.3.1. AVR (Automatic Voltage Regulation) Mode.....	13
3.3.2. PF (Power Factor Regulation) Mode .....	13
3.3.3. VAR (Reactive Power Regulation) Mode.....	13
3.3.4. FCR (Field Current Regulation) Mode .....	14



- 3.4. ANALOGUE INPUTS (S1-S2-S3) ..... 14
  - 3.4.1. Generator Voltage Sensing ..... 14
  - 3.4.2. Generator Current Sensing (A1-A5-B) ..... 14
  - 3.4.3. Network Voltage Sensing (L1-L2)..... 14
  - 3.4.4. Analogue Auxiliary Inputs (E1-E2-M) ..... 14
- 3.5. INPUT CONTACTS ..... 15
  - 3.5.1. START (C1 Contact) ..... 15
  - 3.5.2. STOP (C2 Contact) ..... 15
  - 3.5.3. UP (C3 Contact) ..... 16
  - 3.5.4. DOWN (C4 Contact)..... 16
  - 3.5.5. PAR (C5 Contact)..... 16
  - 3.5.6. PF/VAR (C6 Contact) ..... 17
  - 3.5.7. VMATCH (C7 Contact)..... 17
  - 3.5.8. FCR (C8 Contact, except for M71FA300A model) ..... 17
  - 3.5.9. RESET (C8 Contact, only for M71FA300A model)..... 17
- 3.6. MEC-100 PROTECTIONS ..... 18
  - 3.6.1. Field Over-voltage Protection ..... 18
  - 3.6.2. Field Over-current Protection ..... 18
  - 3.6.3. Generator Over-voltage Protection..... 18
  - 3.6.4. Generator Under-voltage Protection..... 18
  - 3.6.5. Generator Over-current Protection ..... 19
  - 3.6.6. Loss of Sensing Protection..... 19
  - 3.6.7. Diode Failure Monitoring ..... 20
- 3.7. LIMITATION FUNCTIONS ..... 21
  - 3.7.1. Under-frequency Limiter ..... 21
  - 3.7.2. Over-excitation Limiter ..... 22
  - 3.7.3. Under-excitation Limiter ..... 23
  - 3.7.4. Inrush Current Limiter..... 24
- 3.8. PROGRAMMABLE RELAYS..... 24
- 3.9. REACTIVE DROOP COMPENSATION ..... 24
- 3.10. SOFT-START ..... 24
- 3.11. SETTING THE P.I.D. PARAMETERS ..... 25
  - 3.11.1. Proportional, Integral and Derivative Controllers ..... 25
  - 3.11.2. Derivative Adjustments..... 26
  - 3.11.3. P.I.D. in PF/VAR Modes..... 26
- 3.12. DE-EXCITATION (SHUTDOWN) CONTACT: INSTRUCTIONS ..... 26
- 4. INSTALLATION..... 27**
  - 4.1. INTRODUCTION..... 27
  - 4.2. MOUNTING..... 27





4.3. SERIAL COMMUNICATION AND PRELIMINARY SET-UP .....	27
4.4. IMPORTANT NOTES CONCERNING CONNECTIONS - RESTRICTIONS .....	28
4.5. CONNECTIONS (TYPICAL) .....	31
4.5.1. Power Supply from Auxiliary Winding .....	31
4.5.2. Power Supply from PMG (Permanent Magnet Generator) .....	32
4.5.3. Power Supply from Main Terminals, Low Voltage .....	33
4.5.4. Power Supply from Main Terminals, Medium Voltage .....	34
<b>5. MEC-100 INTERFACE SYSTEM .....</b>	<b>35</b>
5.1. INTRODUCTION .....	35
5.2. INSTALLING MEC-100 INTERFACE SYSTEM .....	35
5.2.1. Minimum System Requirements .....	35
5.2.2. Installing the MEC-100 Interface System .....	35
5.2.3. Starting the Program .....	35
5.2.4. Uninstalling the MEC-100 Interface System .....	36
5.2.5. Connection Between MEC-100 and PC .....	36
5.3. START-UP .....	36
5.3.1. Acceptance of the General Contract Conditions .....	36
5.3.2. Description of the Work Window .....	37
5.3.3. Establishing a Communication Link .....	38
5.4. PASSWORD MANAGEMENT .....	39
5.4.1. Entering Password .....	39
5.4.2. Changing Password .....	39
5.5. CHANGING THE SYSTEM SETTINGS .....	40
5.6. SAVING AND RETRIEVING A SET OF PARAMETERS .....	41
5.6.1. Saving a Set of Parameters .....	41
5.6.2. Loading a Set of Parameters .....	41
5.6.3. Checking a Set of Parameters Off-line .....	42
5.6.4. Printing a Set of Parameters .....	42
5.7. DEFINITION OF CONFIGURABLE PARAMETERS .....	43
5.7.1. System Parameters .....	44
5.7.2. Sensing .....	45
5.7.3. Setpoint .....	46
5.7.4. Other Settings .....	48
5.7.5. Stability (P.I.D. Settings) .....	49
5.7.6. Limiters .....	50
5.7.7. Field Protections .....	51
5.7.8. Generator Protections .....	52
5.7.9. Diode Monitoring .....	53



5.8. SYSTEM MONITORING .....	55
5.8.1. Electrical System Parameters .....	55
5.8.2. System Status .....	55
5.8.3. Alarm Status.....	55
5.8.4. Auxiliary Parameter Display .....	56
5.8.5. Phase Graphical Display .....	56
5.8.6. Oscillographic Display .....	56
5.8.7. Power Diagram.....	57
<b>6. SET-UP PROCEDURE .....</b>	<b>58</b>
6.1. MEC-100 INTERFACE SYSTEM INSTALLATION .....	58
6.2. PREPARAZIONE DEL MEC-100 .....	58
6.3. STARTING THE PROGRAM.....	59
6.4. ESTABLISHING A COMMUNICATION LINK.....	59
6.5. ENTERING THE PASSWORD.....	60
6.6. CONFIGURE THE SYSTEM SETTING.....	60
6.7. SAVING A SET OF PARAMETERS.....	68
<b>7. WARRANTY, AFTER SALES SERVICE AND MAINTENANCE .....</b>	<b>69</b>
7.1. WARRANTY.....	69
7.2. PREVENTIVE MAINTENANCE.....	69
7.3. AFTER SALES SERVICE .....	69

# 1. GENERAL INFORMATION

## 1.1. INTRODUCTION – MEC-100 SERIES

The Marelli Motori Digital Regulation Systems included in MEC-100 series are microprocessor-based electronic devices for the set-up and monitoring of the excitation system of Marelli generators with frame size ranging between 400 and 800. The configurability of the system and control parameters makes the MEC-100 series regulators flexible and suitable for a wide range of applications. These regulators are completely resin-bonded and isolated to keep a high operating reliability even in difficult working conditions (high levels of humidity, dust, salty atmosphere) and in presence of vibrations.

## 1.2. MEC-100 SERIES CHARACTERISTICS

### 1.2.1. Functions

- ❖ Four operating modes:
  - Automatic voltage regulation (AVR Mode).
  - Power Factor Regulation (PF Mode).
  - Reactive Power Regulation (VAR Mode).
  - Field Current Regulation (FCR Mode).
- ❖ Stability parameters which can be individually set (P.I.D.) or predefined standard parameterizations.
- ❖ Soft start with a ramp which can be set, in AVR Mode.
- ❖ Generators parallel operation by means of Reactive Droop Compensation.
- ❖ Generator protections:
  - Field over-voltage.
  - Field over-current.
  - Generator over-voltage.
  - Generator under-voltage.
  - Generator over-current.
  - Loss of voltage sensing.
  - Diode Failure Monitoring.
- ❖ Excitation limiters (over-excitation and under-excitation).
- ❖ Under-frequency limiter.
- ❖ Internal Inrush Current limiter.

### 1.2.2. Inputs

- ❖ Generator voltage single-phase or three-phase sensing.
- ❖ Current sensing on single phase (1A or 5A).
- ❖ Network voltage single-phase sensing.
- ❖ 2 auxiliary analogue inputs (4-20mA<sub>dc</sub>) for the setpoint remote control.
- ❖ 8 contacts for external interface.

### 1.2.3. Outputs

- ❖ PWM output up to a maximum of 15A in continuous current.
- ❖ 2 programmable output relays for signalling the occurred alarm.

### 1.2.4. Human-Machine Interface

- ❖ An RS-232 communication port to interface with PC through MEC-100 Interface System software.
- ❖ MEC-100 Interface System software for Windows® to set the generator adjustment and control parameters.

## 1.3. DEVICE SELECTION

The part number and the name, together with the proper suffix, describe the options included in the specific device.

Here below the selection tables:

STYLE NUMBER SELECTION			
DEVICE MODEL	NAME	SUFFIX	PART NUMBER
-	MEC-100	-	M71FA300A
Basic	MEC-100	B	M71FA310A
With Diode Monitoring	MEC-100	D	M71FA320A

OPTIONS GUIDE			
FEATURE	M71FA300A	M71FA310A	M71FA320A
AVR	✓	✓	✓
FCR		✓	✓
PFR	✓	✓	✓
VAR	✓	✓	✓
P.I.D. parameterization	✓	✓	✓
Soft start	✓	✓	✓
Reactive Droop Compens.	✓	✓	✓
Field over-voltage	✓	✓	✓
Field over-current	✓	✓	✓
Generator over-voltage	✓	✓	✓
Generator under-voltage	✓	✓	✓
Generator over-current	✓	✓	✓
Loss of voltage sensing	✓	✓	✓
Diode Failure Monitoring			✓
Over-excitation Limiter	✓	✓	✓
Under-excitation Limiter	✓	✓	✓
Under-frequency Limiter	✓	✓	✓
Internal Inrush Current Lim.	✓	✓	✓
2 analogue inputs 4-20mA	✓	✓	✓
8 digital inputs	✓	✓	✓
Human Machine Interface	✓	✓	✓

Example: to order a MEC-100 with diode monitoring, the following model must be required:

MEC-100 D M71FA320A

## 2. TECHNICAL SPECIFICATIONS

### 2.1. SUPPLY AND POWER

PARAMETER	DATA
Connection type	<ul style="list-style-type: none"> <li>❖ Single-phase</li> <li>❖ Three-phase</li> </ul>
Supply type	<ul style="list-style-type: none"> <li>❖ Auxiliary winding</li> <li>❖ Mains</li> <li>❖ PMG</li> <li>❖ External supply</li> </ul>
Supply voltage type	<ul style="list-style-type: none"> <li>❖ AC: 50 to 277Vac (@ 50 to 400Hz)</li> <li>❖ DC: 60 to 400Vdc</li> </ul>
Voltage build-up	≥5Vac

### 2.2. GENERATOR VOLTAGE SENSING

PARAMETER	DATA
Connection type	<ul style="list-style-type: none"> <li>❖ Single-phase</li> <li>❖ Three-phase</li> </ul>
Voltage Range	From 100Vac to 500Vac, at 50/60Hz

### 2.3. NETWORK VOLTAGE SENSING

PARAMETER	DATA
Connection type	Single-phase
Voltage Range	From 100Vac to 500Vac, at 50/60Hz

### 2.4. GENERATOR CURRENT SENSING

PARAMETER	DATA	
Generator current sensing on W phase	Available inputs	1 channel with 2 available ranges
	Current range	<ul style="list-style-type: none"> <li>❖ 1Aac (@ 50/60Hz)</li> <li>❖ 5Aac (@ 50/60Hz)</li> </ul>

## 2.5. ANALOGUE AUXILIARY INPUTS

PARAMETER		DATA
Auxiliary inputs	Available inputs	2 channels
	Range	4 to 20 mA <sub>dc</sub>

## 2.6. EXCITER FIELD

PARAMETER		DATA
Field resistance	Minimum value	2Ω
Continuative operation	Current range	0 to 10 A <sub>dc</sub>
	Voltage range	0 to 60 V <sub>dc</sub>
10 seconds forcing operation	Current range	0 to 20 A <sub>dc</sub>
	Voltage range	0 to 120 V <sub>dc</sub>

## 2.7. ACCURACY

PARAMETER		DATA
AVR Mode	Voltage regulation accuracy	±0.25% over load range at rated power factor and constant generator frequency
	Steady state stability	±0.1% at constant load and generator frequency
	Thermal drift	±0.5% for a 30°C change in 10 minutes
	V/Hz: voltage accuracy	±2%
	Response time	<1 cycle
FCR Mode	Accuracy	±2%
PF Mode	Accuracy	±2%
VAR Mode	Accuracy	±2%
Voltage matching	Accuracy	±0,5%

## 2.8. LIMITERS AND OTHER FUNCTIONS

PARAMETER		DATA
Soft start	Time adjust range	❖ 1 to 3600s ❖ 1s increment
Voltage matching	Minimum threshold	❖ 90 to 100% of the rated generator voltage ❖ 1% increment
	Maximum threshold	❖ 100 to 110% of the rated generator voltage ❖ 1% increment
Parallel operation	Type	Reactive droop compensation
	Range	0 to 10%
Over-excitation limiter	Type	Inverse time curve
	Thresholds	❖ 1 maximum threshold ❖ Range from 0 to 25A ❖ 0.1A increment ❖ Time delay from 0 to 600s ❖ 0.1s increment ❖ 1 maximum continuative threshold ❖ Range from 0 to 15A ❖ 0.1A increment
Under-excitation limiter	Range	❖ Setpoint setting from 0 to 50% of the maximum rated reactive power. ❖ Curve defined by MEC-100 Interface System.
Under-frequency limiter	Corner frequency	❖ 40 to 60Hz ❖ 0.1Hz increment
	Zero Volt frequency	❖ 0 to 40Hz ❖ 0.1Hz increment



**2.9. PROTECTIONS**

PARAMETER		DATA
<b>Field over-voltage</b>	Range of voltage threshold	❖ 0 to 200Vdc ❖ 1Vdc increment
	Alarm time delay	❖ 0 a 300s ❖ 0.1s
<b>Field over-current</b>	Range of current threshold	❖ 0 to 15Adc ❖ 0.1Adc increment
	Alarm time delay	❖ 0 to 10s ❖ 0.1s increment
<b>Generator over-voltage</b>	Range of voltage threshold	❖ 100 to 150% of the rated generator voltage ❖ 1% increment
	Alarm time delay	❖ 0 to 300s ❖ 0.1s increment
<b>Generator under-voltage</b>	Range of voltage threshold	❖ 0 to 100% of the rated generator voltage ❖ 1% increment
	Alarm time delay	❖ 0 to 300s ❖ 0.1s increment
<b>Generator over-current</b>	Type	Inverse time curve
	Thresholds and alarm time delay	❖ 1 maximum threshold ❖ Range from 0 to 120% of the rated stator current ❖ 1% increment ❖ Time delay from 0 to 3600s ❖ 1s increment ❖ 1 maximum continuative threshold ❖ Range from 0 to 110% of the rated stator current ❖ 1% increment
<b>Loss of sensing</b>	Alarm time delay	<1s
<b>Diode Monitoring</b>	Excitation current ripple levels and time delays	❖ 1 low failure level ❖ Range from 0 to 100% of the rated excitation current ❖ 1% increment ❖ Time delay from 0 to 100s ❖ 1s increment
		❖ 1 high failure level ❖ Range from 0 to 100% of the rated excitation current ❖ 1% increment ❖ Time delay from 0 to 10s ❖ 1s increment

**2.10. CONTACTS**

PARAMETER		DATA
<b>Input contacts</b>	Type	Dry contacts, only for devices equipped with galvanically insulated outputs
	Function	❖ START (excitation start contact) ❖ STOP (excitation stop contact) ❖ UP (increase setpoint) ❖ DOWN (decrease setpoint) ❖ PAR (enable par. operation with gen.) ❖ PF/VAR (enable VAR/PF regulation) ❖ VMATCH (enable voltage matching) ❖ FCR (enable FCR mode)
<b>Output relays</b>	Function	Relays individually associated to alarm functions
	Rated data	1A @ 120Vac / 24Vdc resistive
	Max switched voltage	❖ AC: 120V ❖ DC: 60V
	Max switched current	1A
	Max switched power	120VA, 30W

## 2.11. ENVIRONMENT

PARAMETER		DATA
Operating temperature	Range	-30 to +70°C
Storage temperature	Range	-40 to +80°C

## 2.12. PHYSICAL SPECIFICATIONS

PARAMETER		DATA
Weight	Total weight	1973g
	Length	353.0mm
Dimensions	Width	183.5mm
	Height	52.5mm

## 2.13. EMC

Emission: Reference standard EN 61000-6-3 (2001) + EN 61000-6-3/A11 (2004)		
Test specifications	Environmental Phenomena	Result
EN 55022	Conducted disturbance	Complies
EN 55022	Radiated disturbance	Complies
EN 55014-1	Discontinuous disturbance voltage	Complies
EN 61000-3-2	Harmonic current emissions	Complies
EN 61000-3-3	Voltage fluctuations and flicker	Complies

Immunity: Reference standard EN 61000-6-2 (2005)		
Test specifications	Environmental Phenomena	Result
EN 61000-4-2	Electrostatic discharge	Complies
EN 61000-4-3	Radiated electromagnetic field	Complies
EN 61000-4-4	Electrical fast transients	Complies
EN 61000-4-5	Surge	Complies
EN 61000-4-6	Injected currents	Complies
EN 61000-4-8	Power frequency magnetic field	N.A. (+)
EN 61000-4-11	Dips/short interruptions	Complies

(+) Apparatus does not contain devices susceptible to magnetic fields

The compatibility test results according to the 89/336 EEC and 2004/108 EC Directives and subsequent amendments.

## 3. FUNCTIONAL DESCRIPTION

### 3.1. INTRODUCTION

In the following section a short description of the functions implemented by the MEC-100 and the relevant limits of use is provided. Before using the MEC-100 on any generator, make sure to read carefully and be familiar with all instructions contained in this documentation. If you need more information, please contact the Marelli Technical Support (see Section 6).

### 3.2. POWER AND CARD SUPPLY (P1-P2-P3)

The MEC-100 accepts (terminals P1-P2-P3) a supply single-phase or three-phase alternating voltage ranging between 50 and 277V approximately with a frequency from 50 to 400Hz. The voltage can be obtained from the main machine terminals, the auxiliary winding or the PMG: it is rectified, filtered and used to energize the internal card circuitry and provide, through the chopper output stage, the power necessary for the appropriate generator excitation.

MEC-100 also accepts a supply continuous voltage included between 60 and 400V.

### 3.3. OPERATING MODES

#### 3.3.1. AVR (Automatic Voltage Regulation) Mode

In this operating mode, the MEC-100 allows to adjust the generator voltage.

At the *START* (see Par. 3.5.1), and FCR contact open (C8 contact, see Par. 3.5.8), the MEC-100 always operates in AVR Mode and in this mode all the provided functions are active, excepted for the *Under-excitation Limiter* (see Par. 3.7.3).

#### 3.3.2. PF (Power Factor Regulation) Mode

In this operating mode, the MEC-100 allows to adjust the power factor.

The activation of the PF Mode is obtained by closing the PF/VAR input contact (C6 contact, see Par. 3.5.6), after enabling the same mode during the first configuration step (see Par. 5.7.1). In the PF Mode also the *Under-excitation Limiter* is active (see Par. 3.7.3).

#### 3.3.3. VAR (Reactive Power Regulation) Mode

In this operating mode, the MEC-100 allows to adjust the reactive power.

The activation of the VAR Mode is obtained by closing the PF/VAR input contact (C6 contact, see Par. 3.5.6), after enabling the same mode during the first configuration step (see Par. 5.7.1). In the VAR Mode also the *Under-excitation Limiter* function is active (see Par. 3.7.3).

### 3.3.4. FCR (Field Current Regulation) Mode

In this operating mode, the MEC-100 allows to adjust the excitation current.  
The activation of the FCR Mode can be obtained by closing the FCR input contact (C8 contact, see Par. 3.5.8).

## 3.4. ANALOGUE INPUTS (S1-S2-S3)

### 3.4.1. Generator Voltage Sensing

The MEC-100 offers a wide range of measurement for the generator voltage. You can connect the three sensing terminals (S1-S2-S3) directly to the main machine terminals for the following range: from 100Vac to 500Vac, at 50 - 60Hz frequencies (see Par. 2.2).

For applications with rated generator voltages higher than 500V you need to interpose a step-down transformer, with rated secondary voltage included in the ranges indicated in the relevant specifications.

For the sensing both the single-phase and three-phase connection configurations are provided. In the case of single-phase sensing, the voltage sensed is the line-to-line voltage between the phases U and V ( $U_{UV}$ ).

This input is internally insulated.

### 3.4.2. Generator Current Sensing (A1-A5-B)

The MEC-100 is equipped with a double channel for the sensing of the generator current: a 1A channel (A1-B) and a 5A channel (A5-B), at 50-60Hz frequency, to be connected to a current step-down transformer with a transformation ratio  $I_N/1$  or  $I_N/5$ , where  $I_N$  is the rated generator current. The phase whose current value is measured is the W phase.

This input is internally insulated.

### 3.4.3. Network Voltage Sensing (L1-L2)

The MEC-100 offers a wide range of measurement for the network voltage. The two sensing terminals (L1-L2) can be directly connected to the supply voltage for the following range: from 100Vac to 500Vac, at 50 - 60Hz frequencies (see Par. 2.3).

For applications with supply voltages higher than 500V a step-down transformer must be interposed, with rated secondary voltage included in the ranges indicated in the relevant specifications.

The only single-phase connection configuration is provided.

This input is internally insulated.

### 3.4.4. Analogue Auxiliary Inputs (E1-E2-M)

The MEC-100 is provided with two auxiliary inputs to control the voltage, power factor, reactive power and excitation current setpoints by means of an external device (1<sup>st</sup> In.: terminals E1-M; 2<sup>nd</sup> In.: terminals E2-M).

These inputs can be used by applying a 4-20mA current and they can be individually associated to two regulation Modes.

To the control current range corresponds the range established during set-up for the relative associated setpoint (see Par. 5.7.3).



*For example, if voltage setpoint limits are set to 80 and 120% of the generator rated voltage, 4mA will be associated to the minimum limit (80%) and 20mA to the maximum limit (120%), and all the intermediate values of the generator voltage setpoint will proportionally correspond to the current values between 4 and 20mA.*



#### **WARNING: THESE INPUTS ARE NOT INTERNALLY INSULATED.**

The external device to which these inputs should be connected must be equipped with a galvanically insulated output. Marelli Motori is under no liability for any damages which may occur to the AVR, the plant or the persons, or for lost earnings, or financial loss, or system stoppages, due to no insulation between MEC-100 and other external device connected to these inputs.

### 3.5. INPUT CONTACTS

The MEC-100 is equipped with 8 input contacts for the operational control of the regulation modes. Here below the description of the functions related to these contacts is provided.



**WARNING: THESE INPUTS ARE NOT INTERNALLY INSULATED.**

The external device to which these inputs should be connected must be equipped with a galvanically insulated output. Marelli Motori is under no liability for any damages which may occur to the AVR, the plant or the persons, or for lost earnings, or financial loss, or system stoppages, due to no insulation between MEC-100 and other external device connected to these inputs.

#### 3.5.1. START (C1 Contact)

Excitation start contact (normally open, switch logic): when this contact is closed, the MEC-100 supplies power to the exciter field and continues to do so until the contact remains closed. When this contact is opened, the power supply to the exciter field is stopped.

If the excitation is present (*START* contact closed) and the temporary *STOP* contact is closed (see Par. 3.5.2), the *START* contact is disabled and to supply the excitation power again it is necessary first to open and then re-close the *START* contact (with *STOP* opened).

When the *START* contact is closed, the LED corresponding to the *Excitation State* item in the system status window in *System Monitoring* (see Par. 5.8.2) becomes green.



**WARNING: START CONTACT MUST NOT BE CONSIDERED OR USED AS EMERGENCY AND/OR SAFETY DEVICE.**

*START* contact has only an operating function, it can not be considered or used as emergency and/or safety device. Marelli Motori is under no liability for any damages which may occur to the AVR, the plant or the persons, or for lost earnings, or financial loss, or system stoppages, due to a not allowed use of *START* contact.

#### 3.5.2. STOP (C2 Contact)

Excitation stop contact (normally open, momentary pushbutton logic): when this contact is temporarily closed, the MEC-100 stops the power supply to the exciter field. When the stop command is given, the MEC-100 does not supply the exciter field and the contact can be left again. This input is priority to the *START* contact.

If the excitation is present (*START* contact closed) and the temporary *STOP* contact is temporarily closed, the *START* contact is disabled and to supply the excitation power again it is necessary first to open and then re-close the *START* contact (with *STOP* opened).

When the *STOP* contact is closed, the LED corresponding to the *Operating Status* item in the system status window in *System Monitoring* (see Par. 5.8.2) turns off.

*STOP* can be associated to the de-excitation (shutdown) contact (see Par. 3.12)



**WARNING: STOP CONTACT MUST NOT BE CONSIDERED OR USED AS EMERGENCY AND/OR SAFETY DEVICE.**

*STOP* contact has only an operating function, it can not be considered or used as emergency and/or safety device. Marelli Motori is under no liability for any damages which may occur to the AVR, the plant or the persons, or for lost earnings, or financial loss, or system stoppages, due to a not allowed use of *STOP* contact.

### 3.5.3. UP (C3 Contact)

Active operational setpoint increasing contact (normally open, momentary pushbutton logic):

- ❖ AVR Mode: increases the generator voltage setpoint.
- ❖ PF Mode: if the power factor setpoint is of inductive type, decreases the power factor; if the setpoint is of capacitive type, increases the power factor.
- ❖ VAR Mode: increases the reactive power setpoint.
- ❖ FCR Mode: increases the excitation current setpoint.

The setpoint increase is strictly related to the range established for the setpoint (see Par. 5.7.3) and the variation speed (or traverse rate, see Par. 5.7.4).



*It is assumed that the inductive reactive power is of positive sign and the capacitive reactive power of negative sign. In parallel with the network (PF Mode or VAR Mode active) the UP contact increases the reactive power value so as to obtain the desired power factor or reactive power setpoint depending on the selected regulation Mode.*



**WARNING: THE UP CONTACT CAN NOT BE USED FOR ENDLESS REPETITIVE PURPOSES.**

The UP contact can only perform a current setpoint change for spot operations; the endless repetitive use of the contact is forbidden. If a continuous setpoint matching is required, the auxiliary analogue inputs E1-E2-M must always be used (see Par. 3.4.4).

### 3.5.4. DOWN (C4 Contact)

Active operational setpoint decreasing contact (normally open, momentary pushbutton logic):

- ❖ AVR Mode: decreases the generator voltage setpoint.
- ❖ PF Mode: if the power factor setpoint is of inductive type, increases the power factor; if the setpoint is of capacitive type, decreases the power factor.
- ❖ VAR Mode: decreases the reactive power setpoint.
- ❖ FCR Mode: decreases the excitation current setpoint.

The setpoint decrease is strictly related to the range established for the setpoint (see Par. 5.7.3) and the variation speed (traverse rate, see Par. 5.7.4).



*It is assumed that the inductive reactive power is of positive sign and the capacitive reactive power of negative sign. In parallel with the network (PF Mode or VAR Mode active) the DOWN contact decreases the reactive power value so as to obtain the desired power factor or reactive power setpoint depending on the selected regulation Mode.*



**WARNING: THE DOWN CONTACT CAN NOT BE USED FOR ENDLESS REPETITIVE PURPOSES.**

The DOWN contact can only perform a current setpoint change for spot operations; the endless repetitive use of the contact is forbidden. If a continuous setpoint matching is required, the auxiliary analogue inputs E1-E2-M must always be used (see Par. 3.4.4).

### 3.5.5. PAR (C5 Contact)

Generators parallel enabling contact (normally open, switch logic): this input activates the *Droop* mode for paralleling one or more generators (for the *Droop* function see Par. 3.9). When this contact is closed the excitation limiters, provided for the operating mode in parallel, are enabled and the voltage matching function is disabled (see Par. 3.5.7).

When the PAR contact is closed, the LED corresponding to the *Reactive Droop Compensation* item in the system status window in *System Monitoring* (see Par. 5.8.2) becomes green.



**WARNING: CONTACT PAR MUST ALWAYS BE TURNED OFF (C5 OPEN) BEFORE STOPPING THE GENERATOR.**

### 3.5.6. PF/VAR (C6 Contact)

PF/VAR Mode enabling contact (normally open, switch logic): this input activates the PF (Power Factor) or VAR (Reactive Power) regulation Mode (depending on the previously selected Mode, see Par. 5.7.1), for the mains parallel operations. When this contact is closed the excitation limiters, provided for the operating mode in parallel, are enabled and the voltage matching function is disabled (see Par. 3.5.7).

When the *PF/VAR* contact is closed, the LED corresponding to the *Parallel with Line* item in the system status window in *System Monitoring* (see Par. 5.8.2) becomes green.

### 3.5.7. VMATCH (C7 Contact)

Voltage matching enabling contact (normally open, switch logic): this input enables the voltage matching function from the MEC-100; if the network voltage value measured by the MEC-100 is included in the range of set values (values referred to the generator rated voltage, see Par. 5.7.4), the generator voltage setpoint is automatically modified from the pre-established value to the network voltage value in a fixed time interval of 10-15 seconds approximately.

When the *PAR* or the *PF/VAR* contact is closed the voltage matching function is disabled and remains disabled until both the *PAR* and *PF/VAR* contacts are opened.

When the *VMATCH* contact is closed (and both the *PAR* and *PF/VAR* contacts are disabled), the LED corresponding to the *Voltage Matching* item in the system status window in *System Monitoring* (see Par. 5.8.2) becomes green.

### 3.5.8. FCR (C8 Contact, except for M71FA300A model)

FCR enabling contact (normally open, switch logic): this input enables the FCR Mode for excitation current regulation (Field Current Regulation, see Par. 3.4.4).

FCR Mode can be automatically selected in case of loss of sensing and *Shutdown* Mode enabled (see. Par. 5.7.8), and it does not depend on the status of FCR contact.

When the FCR function is operating, the LED corresponding to the *Field Current Regulation FCR* item in the system status window in *System Monitoring* (see Par. 5.8.2) becomes green.



#### **WARNING: BE CAREFUL IN THE USE OF THE FCR MODE.**

The excitation current value in FCR mode must be chosen considering the generator specifications and the operations to do: a too high excitation current value can lead to over-excitation and/or overvoltage conditions dangerous for the generator and/or the plant (incautious use). **A initial low value is suggested, not higher than the excitation current in no load condition.** Marelli Motori is under no liability for any damages which may occur to the AVR, the plant or the persons, or for lost earnings, or financial loss, or system stoppages, due to an incautious use of FCR mode.

### 3.5.9. RESET (C8 Contact, only for M71FA300A model)

Alarm reset contact (normally open, momentary pushbutton logic): this input allows to reset all active alarms as a result of the intervention of one or more protections or limitations.



*The alarm reset should usually be operated after the intervention on the system to remove the causes of the alarm condition. If the system is still working and the alarm causes have not been removed, the RESET contact interrupts the alarms for about a second, after which they are reactivated.*

### 3.6. MEC-100 PROTECTIONS

The MEC-100 offers 7 protection functions which consist in transmitting externally a warning, of visual type, through MEC-100 Interface System, and/or of signal type, by associating this last to a relay.

#### 3.6.1. Field Over-voltage Protection

When the measured field voltage increases above a value threshold which can be set, for a time interval whose length can be established, the field over-voltage protection is activated.

The activation of this protection is accompanied by a visual warning in the MEC-100 Interface System (*Field Overvoltage Protection* item flashing, see Par. 5.8.3) and optionally can be associated to one of the two programmable output relays.

The activation voltage threshold can be set between 0 and 200Vdc with increases of 1Vdc and the operation time (measured by an internal timer) between 0 and 300s with increases of 0.1s. When the voltage falls below the defined threshold, the protection timer is reset to zero.

This function can be enabled/disabled.

#### 3.6.2. Field Over-current Protection

When the measured field current increases above a value threshold which can be set, for a time interval whose length can be established, the field over-current protection is activated.

The activation of this protection is accompanied by a visual warning in the MEC-100 Interface System (*Field Overcurrent Protection* item flashing, see Par. 5.8.3), and optionally can be associated to one of the two programmable output relays.

The activation current threshold can be set between 0 and 15Adc with increases of 0.1Adc and the operation time (measured by an internal timer) between 0 and 10s with increases of 0.1s. When the current falls below the defined threshold, the protection timer is reset to zero.

This function can be enabled/disabled.

#### 3.6.3. Generator Over-voltage Protection

When the measured generator voltage increases above a value threshold which can be set, for a time interval whose length can be established, the generator over-voltage protection is activated.

The activation of this protection is accompanied by a visual warning in the MEC-100 Interface System (*Generator Overvoltage Protection* item flashing, see Par. 5.8.3), and optionally can be associated to one of the two programmable output relays.

The activation voltage threshold can be set in the form of percentage of the generator rated voltage, between 100 and 150% with increases of 1%, the operation time (measured by an internal timer) can be determined between 0 and 300s with increases of 0.1s. When the voltage falls below the defined threshold, the protection timer is reset to zero.

This function can be enabled/disabled.

#### 3.6.4. Generator Under-voltage Protection

When the measured generator voltage falls below a value threshold which can be set, for a time interval whose length can be established, the generator under-voltage protection is activated.

The activation of this protection is accompanied by a visual warning in the MEC-100 Interface System (*Generator Undervoltage Protection* item flashing, see Par. 5.8.3), and optionally can be associated to one of the two programmable output relays.

The activation voltage threshold can be set in the form of percentage of the generator rated voltage, between 0 and 100% with increases of 1%, the operation time (measured by an internal timer) can be determined between 0 and 300s with increases of 0.1s. When the voltage increases above the defined threshold, the protection timer is reset to zero.

This function can be enabled/disabled.



### 3.6.5. Generator Over-current Protection

The MEC-100 is capable of monitoring the value taken by the generator stator current under load conditions and sending a warning when the current value exceeds a predefined limit for a pre-established time interval; this time interval can be derived from a curve of the type shown in Fig. 3.6.5.a. All of that before the over-current causes a generator overheating/failure.

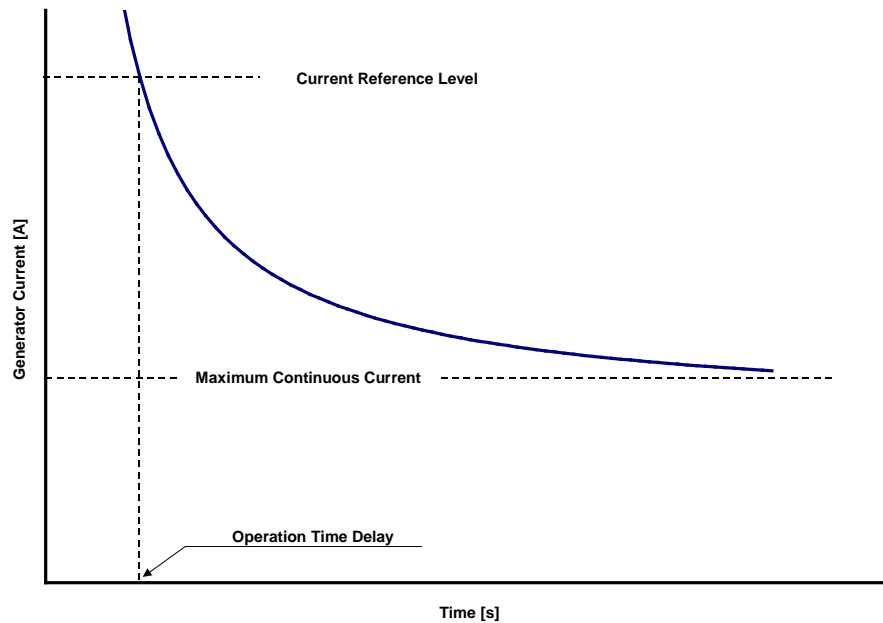

**Fig. 3.6.5.a**  
**Generator Over-current Protection Curve**

The characteristic curve is calculated starting from the determination of a maximum continuative current level (given in percentage compared with the generator rated current value, with values included between 0 and 110%, and minimum increase of 1%), a current reference level (expressed in percentage compared with the generator rated current value, with values included between 0 and 120%, and minimum increase of 1%) and a minimum operation time value (time delay from 0 to 3600s, minimum increase of 1s) associated to the reference level.

When the stator current value exceeds the maximum continuous current value, the generator over-current protection is activated by a warning signal after a time interval depending on the generator current value which has been reached, according to the curve of Fig. 3.6.5.a.

Higher the over-current, shorter the operation time (time delay).

The activation of this protection is accompanied by a visual warning in the MEC-100 Interface System (*Generator Overcurrent Protection* item flashing, see Par. 5.8.3), and optionally can be associated to one of the two programmable output relays.

This function can be enabled/disabled.

### 3.6.6. Loss of Sensing Protection

The MEC-100 is capable of sensing the over-excitation conditions resulting from the loss of voltage sensing and coming into operation by a warning signal in less than 1s.

The activation of this protection is accompanied by a visual warning in the MEC-100 Interface System (*Loss of Sensing Protection* item flashing, see Par. 5.8.3), and optionally can be associated to one of the two programmable output relays.

The *Loss of Sensing* protection can directly operate one of the two following actions (preliminary choice is required, see Par. 5.7.8):

- ❖ *Shutdown*: the MEC-100 operates the instantaneous de-excitation (shutdown) of the generator.
- ❖ *FCR*: the MEC-100 automatically changes over to FCR mode, supplying the excitation current value set in the *Setpoint* window (see Par. 5.7.3).

This function can be enabled/disabled.



**WARNING:** Any activation of the protection when it is enabled will cause an excitation shutdown or a change over to the FCR mode. Before enabling the protection, please make sure that the chosen protection option is not dangerous for the plant or the network to which the generator is connected. Marelli Motori is under no liability for any damages which may occur to the AVR, the plant or the persons, or for lost earnings, or financial loss, or system stoppages, due to a not suitable use of the *Loss of Sensing Protection*.

### 3.6.7. Diode Failure Monitoring

The MEC-100 is capable of sensing abnormal excitation currents due to the damaging of one or more diodes in the generator rectifier bridge (interrupted or shorted diode). These currents can lead to the exciter and/or regulator damaging.

MEC-100 measures the excitation current (average value) and the width of its ripple. If a diode is damaged, the excitation current ripple is higher than the one present in correct behaviour conditions, as showed in Fig. 3.6.7.a. MEC-100 offers two types of protection threshold or failure level: *Low Level* and *High Level* of failure. The two thresholds can be chosen in such a way to discern from a light failure (i.e. interrupted diode) to a heavy failure (i.e. shorted diode).

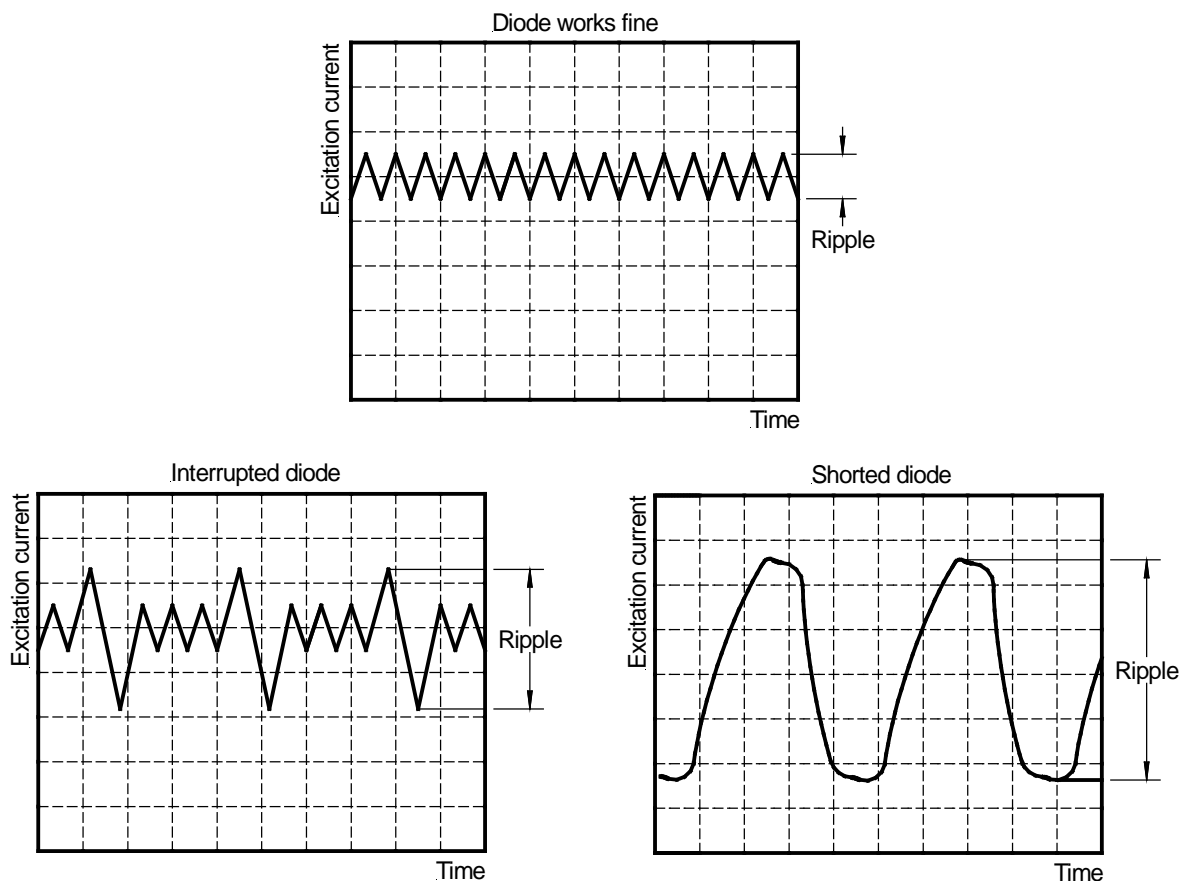

Fig. 3.6.7.a  
Excitation current when diode fails.

For example, the two levels can be chosen with the following method:

- ❖ If excitation current ripple is lower than the *Low Level* of failure, the rectifier bridge can be considered properly working.
- ❖ If excitation current ripple is higher than the *Low Level* of failure (for a period longer than the set delay) but lower than the *High Level* of failure, the *Low Level* alarm occurs. This situation could be associated for example to a light failure (i.e. interrupted diode) which can not damage the generator in a short period of time, but has to be anyway solved.
- ❖ If excitation current ripple is higher than the *High Level* of failure (for a period longer than the set delay), the *High Level* alarm occurs. This situation could be associated for example to a heavy failure (i.e. shorted diode) which can damage the generator in a short period of time, and has to be solved as soon as possible.

The activation of this protection is accompanied by a visual warning in the MEC-100 Interface System: when *Low Level* is reached, *Diode Monitoring - Low Level* item starts flashing (see Par. 5.8.3) and optionally can be associated to one of the two programmable output relays.

When *High Level* is reached, *Diode Monitoring - High Level* item starts flashing (see Par. 5.8.3) and optionally can be associated to one of the two programmable output relays or to the *Shutdown* option.

This function can be enabled/disabled.

### 3.7. LIMITATION FUNCTIONS

#### 3.7.1. Under-frequency Limiter

The MEC-100 reduces the excitation current any time the generator is used at low speed to avoid damages to the generator excitation system: in particular the voltage setpoint is automatically modified and reduced as soon as the generator frequency falls below a set value, according to the curve shown in Fig. 3.7.1.a.

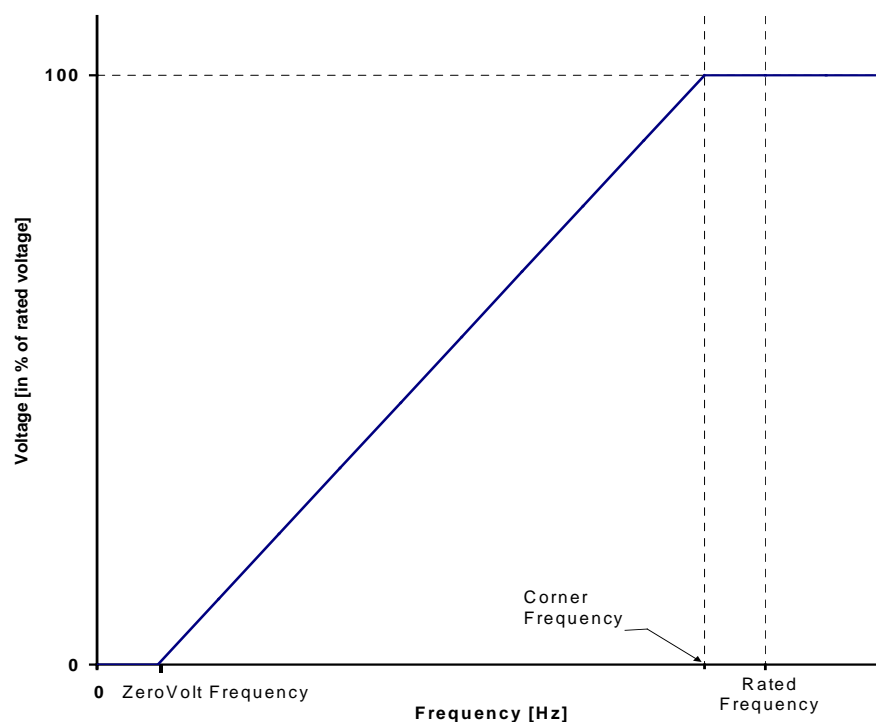

Fig. 3.7.1.a  
Generator Voltage Setpoint in Under-frequency Conditions

The parameters which determine the curve and, in particular, its slope are the following:

- ❖ The *Corner Frequency*, which can be set from 40 to 60Hz with increases of 0.1Hz: represents the frequency value below which the MEC-100 decreases the voltage setpoint.
- ❖ The *Zero Volt Frequency*, which can be set from 0 to 40Hz with increases of 0.1Hz: represents the frequency relative to the point where the voltage setpoint is zeroed.

The activation of this limitation function is accompanied by a visual warning in the MEC-100 Interface System (*Underfrequency Limiter* item flashing, see Par. 5.8.3).

This function is always enabled and operates in AVR Mode.

### 3.7.2. Over-excitation Limiter

The MEC-100 is capable of reducing the excitation current when this last reaches such a value as to cause the overheating of the exciter field. When this function is active (the activation results from the relevant authorization) and a field over-current takes place, the field current value is decreased to a safety value, within a pre-established time interval, which can be derived from the curve shown in Fig. 3.7.2.a.

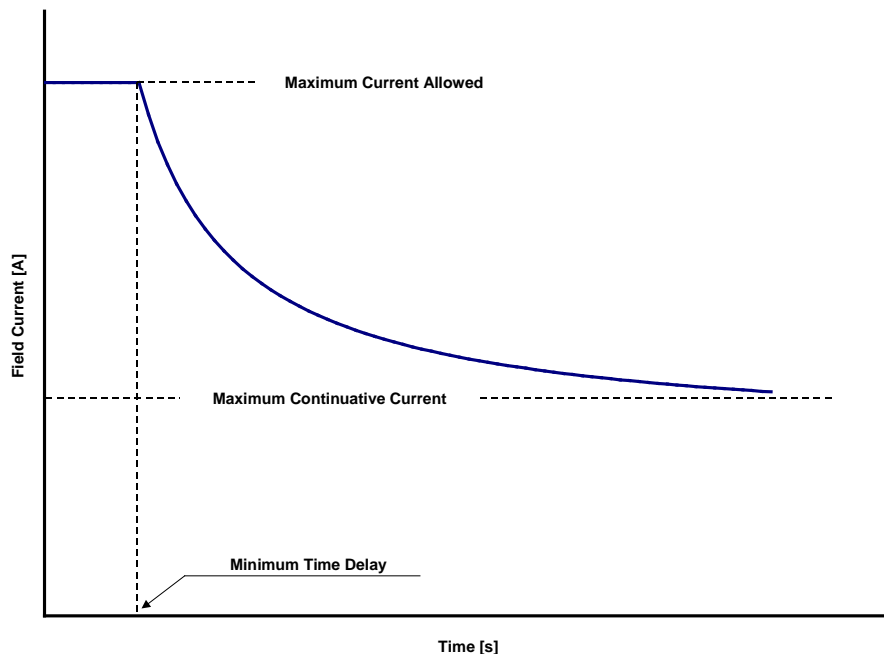

Fig. 3.7.2.a  
Excitation Limiter Curve

This characteristic curve is calculated starting from the determination of a maximum current level which can never be exceeded (with value included between 0 and 25A, minimum increase of 0.1A), a minimum operation time value (0 to 10s, minimum increase of 0.1s) and a maximum field current value which the MEC-100 can support continuously without the activation of the relevant protection (0 to 15A, minimum increase of 0,1A).

When the field current value exceeds the maximum continuative current value, the field over-current limitation is activated after a time interval depending on the field current value which has been reached, according to the curve of Fig. 3.7.2.a.

Higher the over-current, shorter the operation time.

The activation of this limitation consists in reducing the field current until the maximum continuative current value is reached. This current value is maintained until both the following conditions are simultaneously satisfied:

- ❖ Enough time is passed to eliminate the generator overheating.
- ❖ The operating conditions set the excitation current value required to the MEC-100 below the maximum continuous current value.

The activation of this limitation is accompanied by a visual warning in the MEC-100 Interface System (*Overexcitation Limiter* item flashing, see Par. 5.8.3), and optionally can be associated to one of the two programmable output relays.

This function can be enabled/disabled:

- ❖ If enabled, it can operate in all working Modes.
- ❖ Even if disabled, the MEC-100 limits the maximum excitation current which can be supplied to the maximum allowed set value.

### 3.7.3. Under-excitation Limiter

The MEC-100 is capable of activating an under-excitation limitation function to avoid demagnetizing effects and losses of synchronism during the paralleling operations. When this function is active (the activation results from the relevant authorization), the MEC-100 senses the reactive power output (of demagnetizing type) and limits any consequent field current reduction.

The area of operation of the under-excitation limitation function is identified by a curve like that shown in Fig. 3.7.3.a.

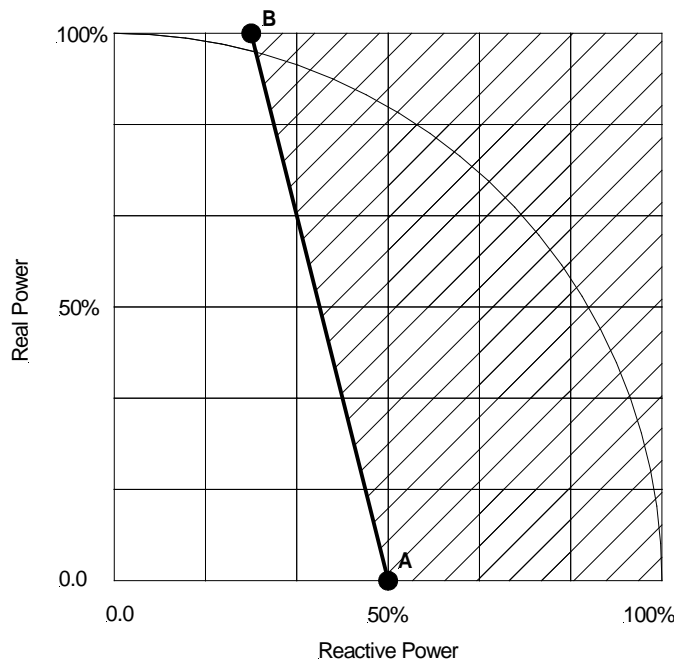

**Fig. 3.7.3.a**  
**Under-excitation Limitation Curve**

As you can see in the figure above, the dashed portion is the area where the MEC-100 cannot operate; the limitation will be activated to prevent the working point from leaving the allowed operating area.

The limitation curve is obtained starting from the definition of the A point (see example of Fig. 3.7.3.a), identified by the limit reactive power value with power factor equal to 0, expressed in percentage (0 to 50%, minimum increase of 1%) compared to the maximum reactive power.



By the term *maximum reactive power* it is meant the reactive power which can be obtained with rated voltage, rated current and power factor  $PF=0$ , that is at zero active power.



The MEC-100 calculate automatically the limitation curve: in particular, the B point will have the half of the limit reactive power value at zero active power as abscissa (25% in the case shown in figure) and 100% of the active power at  $PF=1$  as ordinate.

The activation of this limitation is accompanied by a visual warning in the MEC-100 Interface System (*Underexcitation Limiter* item flashing, see Par. 5.8.3), and optionally can be associated to one of the two programmable output relays.

This function can be enabled/disabled.

### 3.7.4. Inrush Current Limiter

The MEC-100 is equipped with an internal protection against the so-called “Inrush Current” or “Input Surge Current”, that is the maximum, instantaneous input current which appears when the device input stage is instantaneously energized. The limiter acts only on the inrush current, while it has not any further influence on the normal working of the MEC-100.

## 3.8. PROGRAMMABLE RELAYS

The protection and limitation functions which can be set from MEC-100 Interface System can be individually associated to each one of the two programmable relays provided with the MEC-100. The provided contacts are normally open and the relevant technical data are specified in Par. 2.10.

## 3.9. REACTIVE DROOP COMPENSATION

The MEC-100 provides a Reactive Droop Compensation function: it is used to obtain the desired distribution of the reactive load between two or more generators which operate in parallel.

When this function is enabled, the MEC-100 calculates the reactive part of the generator load, starting from the measurement of the generator voltage between the U and V phases and the current of the W phase (see Par. 4.5), and modifies consequently the generator voltage setpoint.

A unit power factor does not lead to any change of the voltage setpoint. An inductive power factor (“lagging”) leads to a decrease in the generator output voltage (*Droop*). A capacitive power factor (“leading”) leads to an increase in the generator output voltage.



*If with inductive-type load an increase in the generator voltage occurs, the following conditions must be verified:*

- ❖ *the U phase is connected to S1 and the V phase is connected to S2.*
- ❖ *the current sensing is made on the W phase.*

*If both points are verified, then it is necessary to reverse the two wires coming from the measurement TA on the generator current sensing terminals.*

*Droop* can be set from 0 to 10%, with increase of 0.1%, with phase current equal to the rated generator current and power factor corresponding to 0.80.

This function is enabled by closing the PAR contact (C5 contact, see Par. 3.5.5).

It can only be activated in AVR Mode. The switching to the PF or VAR Mode disables automatically the Reactive Droop Compensation.

During parallel operation between two or more generators (PAR contact closed), the LED corresponding to the *Reactive Droop Compensation* item in the system status window in *System Monitoring* (see Par. 5.8.2) becomes green.

## 3.10. SOFT-START

The MEC-100 provides the SOFT-START function to bring linearly the generator voltage from the residual value to the reference one, in a time interval whose length can be defined, with minimum overshoot. For this function, it is enough to set only one parameter: that is, the ramp-up time of the voltage setpoint. This parameter, whose value is included between 0 and 3600s with increases of 1s, accounts for the time necessary to the MEC-100 to lead the voltage setpoint from 0Vac to 100% of its predefined value (the rated voltage), starting from the moment when the MEC-100 is enabled from the *START* contact (see Par. 3.5.1). In Fig. 3.10.a. the ideal time diagram of the voltage setpoint during the SOFT-START function is shown.



*The diagram in Figure 3.10.a refers to the ideal curve which the card processor makes the voltage setpoint follow to reach 100% of the pre-established value. Obviously, under real conditions, and at full rpm, the generator voltage does not start from 0Vac, but from the residual machine voltage value; moreover, under real conditions, starting from 0rpm up to reach the rated speed, the voltage ramp-up may not be perfectly linear, but on the contrary may present a light overshoot at low frequencies and voltages (in any case included within a range of not significant values).*

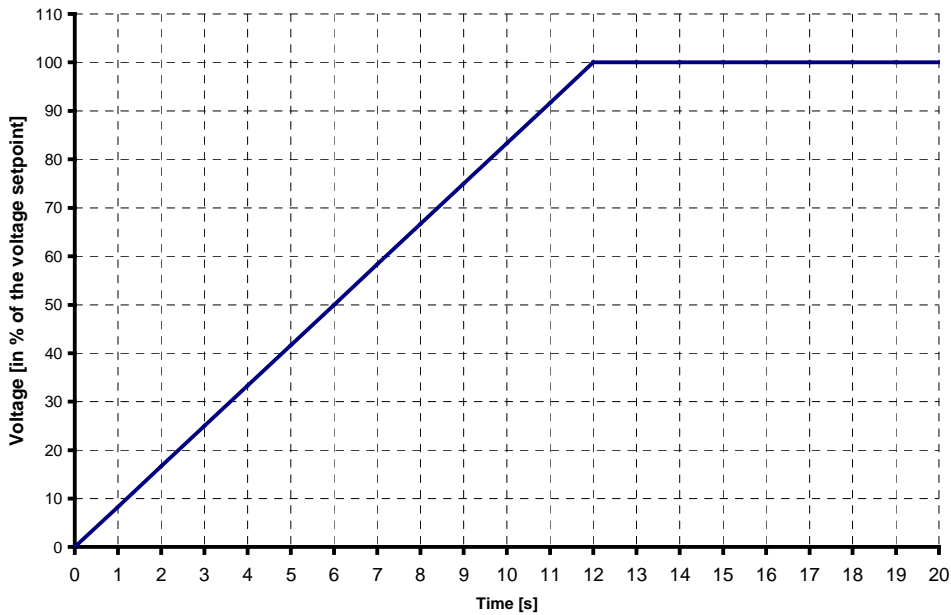

**Fig. 3.10.a**  
**Generator Voltage Setpoint when the SOFT-START Function is Active**

**3.11. SETTING THE P.I.D. PARAMETERS**

One of the functions which make the MEC-100 a particularly efficient and flexible device is the configurability of the parameters that define the transient performances and the stability of the control system. In particular, the MEC-100 system allows to use P.I.D. (Proportional, Integral, Derivative) controllers which can be individually set by the direct insertion of the values corresponding to the relevant constants:  $K_P$ ,  $K_I$ , and  $K_D$ .

**3.11.1. Proportional, Integral and Derivative Controllers**

In the Table below an indicative scheme is provided where the  $K_P$ ,  $K_I$ , and  $K_D$  values are determined starting from the hypothesis of submitting the closed chain system to a step input.

<i>Controller</i>	<i>Ramp-up Time</i>	<i>Overshoot</i>	<i>Transient Length</i>	<i>Steady-State Error</i>
Increase of $K_P$	Decreases	Increases	Does not influence	Decreases
Increase of $K_I$	Decreases	Increases	Increases	Eliminated
Increase of $K_D$	Does not influence	Decreases	Decreases	Does not influence

It is to be specified that the above-mentioned relationships are not accurate, since controllers depend each other, but they can be considered enough to tune controllers in order to obtain the best possible transient response.

Generally speaking, the Proportional controller ( $K_P$ ) will contribute to reduce the step-response rise time (parameter which characterizes the response readiness) and decrease, but not to eliminate, the steady-state error. The Integral controller (I controller with  $K_I$  constant) eliminates the steady-state error but worsens the transient response (reduces the stability). The Derivative controller ( $K_D$ ) increases the stability of the system, by improving the transient response.

### 3.11.2. Derivative Adjustments

The MEC-100 Interface System provides two further adjustment parameters (for derivative adjustments) to improve the transient response:

- ❖ *1<sup>st</sup> Derivative Item – Time*: describes the number of sampling intervals, referred to the discrete time, used for the derivate calculation.
- ❖ *2<sup>nd</sup> Derivative item – Filter*: describes the time constant, referred to the discrete time, of the low-pass filter used to eliminate the derivate noise.

### 3.11.3. P.I.D. in PF/VAR Modes

The MEC-100 Interface System provides 3 P.I.D. controllers and 2 derivative adjustments to set the stability in AVR Mode. Only P.I. controllers must be set in PF and VAR Modes.

For the setting of each parameter, see Par. 5.7.5.

## 3.12. DE-EXCITATION (SHUTDOWN) CONTACT: INSTRUCTIONS

Most of the generator connection diagrams include a de-excitation (shutdown) contact between the generator power source (main terminals, auxiliary winding, PMG, etc.) and the MEC-100 supply terminals P1-P2(-P3 if used), see Par. 4.4.

Switching-off the de-excitation contact leads to stop powering the generator exciter in a short time.

Especially in generator/hydro turbine applications, the load rejection (i.e. when generator is paralleled with the network) must be always simultaneously accompanied by the prompt excitation shutdown of the generator, in order to limit the generator over-voltage due to the load rejection and the turbine over-speed.



**In case of hydro turbine applications, the de-excitation contact must be always switched-off simultaneously with the load rejection and/or disconnection from parallel operation.**

Generally, Marelli Motori recommends to associate the momentary switch-on of the STOP contact (C2) to the switch-off of the de-excitation contact. This procedure permits to accelerate the excitation shutdown and strongly limit the generator over-voltage.



**WARNING: during the parallel operations, STOP contact and/or de-excitation contact can be only used simultaneously with the load rejection and/or disconnection from parallel operation.**



**WARNING: read carefully all the instructions about START and STOP contacts operating use, see Par. 3.5.**



**WARNING: Marelli Motori recommends to associate STOP contact to the de-excitation contact only for improving the generator transient performance during the load rejection and/or disconnection from parallel operation, and safe the MEC-100 regulation system.  
Marelli Motori is under no liability for any damages which may occur to the AVR, the plant or the persons, or for lost earnings, or financial loss, or system stoppages, due to a wrong or not allowed use of STOP and de-excitation contacts.**



## 4. INSTALLATION

### 4.1. INTRODUCTION

In this section the instructions for the mechanical fastening of the MEC-100 and its electrical connection are provided.

### 4.2. MOUNTING

The MEC-100 support is conceived for two typologies of mounting:

- ❖ *On-board machine mounting*: the fastening on vibration dampers and proper brackets is provided; the brackets should be secured to the machine terminal board panel, see Fig. 4.2.a, page 28.
- ❖ *Panel mounting*: the fastening should be done at the 4 holes shown in Fig. 4.2.b, page 29.

### 4.3. SERIAL COMMUNICATION AND PRELIMINARY SET-UP

The MEC-100 is equipped with an RS-232 serial port located on the card component side: it consists of a DB-9 female connector.

For the connection to Personal Computer (see Section 5 for the MEC-100 Interface System setting instructions) a standard communication cable ending with a DB-9 female connector is required.

In Fig. 4.3.a the provided pin-to-pin connection is shown.

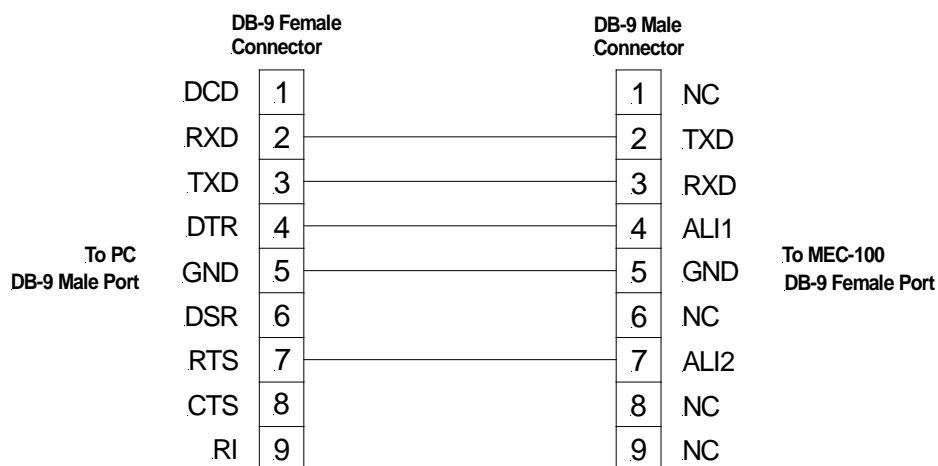

Fig. 4.3.a  
MEC-100 Serial Connection to Personal Computer

If the DB-9 serial port is not available on PC, one of the USB ports must be used, paying attention to:

- ❖ Interpose an USB/DB-9 adapter between the standard cable and the PC.
- ❖ Install the adapter driver files on PC (please follow the provided instructions).

It is possible to set the MEC-100 regulation parameters only if the MEC-100 is properly supplied, as described in Par. 2.1.

The MEC-100 is properly supplied if connected to a working generator (operating at rated voltage and rated frequency), according to the provided connection diagrams, or supplied from an external supplier.

It is always advisable to supply the MEC-100 with the minimum voltage values included into the allowed supply voltage range (see Par. 2.1). It is strongly recommended to not supply MEC-100 with voltage values  $\geq 220\text{Vac}$ .

See the Set-up Procedure widely described in Section 6.



**WARNING: Before doing any operations and/or any set-up on MEC-100, it is to be taken into consideration that lethal voltage is present at the top panel when the unit is energized. Top panel connections and/or operations should be made only when the unit is de-energized.**

#### 4.4. IMPORTANT NOTES CONCERNING CONNECTIONS - RESTRICTIONS

The MEC-100 is equipped with an RS-232 serial port located on the card component side: it consists of a DB-9 female connector.



**WARNING: For all the applications with MEC-100, the CONNECTIONS MUST ALWAYS COMPLY WITH THE MARELLI CONNECTION DIAGRAMS provided with the generator. If included in the Marelli connection diagrams, the DE-EXCITATION (SHUTDOWN) CONTACT MUST ALWAYS BE USED (see instructions in Par. 3.12). ALL TYPES OF SWITCH OR OTHER DEVICE not formally included in the Marelli connection diagrams CAN NOT BE USED AND/OR PUT on the MEC-100 output and/or exciter field, without previous authorization of Marelli Motori S.p.A. skilled personnel. Should further information about the connection diagrams and/or the used components be required, Marelli Service (see Par. 7.3) must always be contacted and/or involved BEFORE the MEC-100 commissioning.**



**WARNING: if the MEC-100 application environment is affected by electromagnetic disturbance (EMI) higher than the specific limits described in Par. Errore. L'origine riferimento non è stata trovata., the User must equip the MEC-100 system of the the proper and suitable protections (shielded cables, ferrites, etc.) on his own. EMI out of specifications can lead to improper working of MEC-100 and/or to hardware damages. Marelli Motori is under no liability for any damages which may occur to the AVR, the plant or the persons, or for lost earnings, or financial loss, or system stoppages, due to missing application of EMI protections. Should further information about the EMI protection of the system be required, Marelli Service (see Par. 7.3) must always be contacted and/or involved BEFORE the MEC-100 commissioning.**

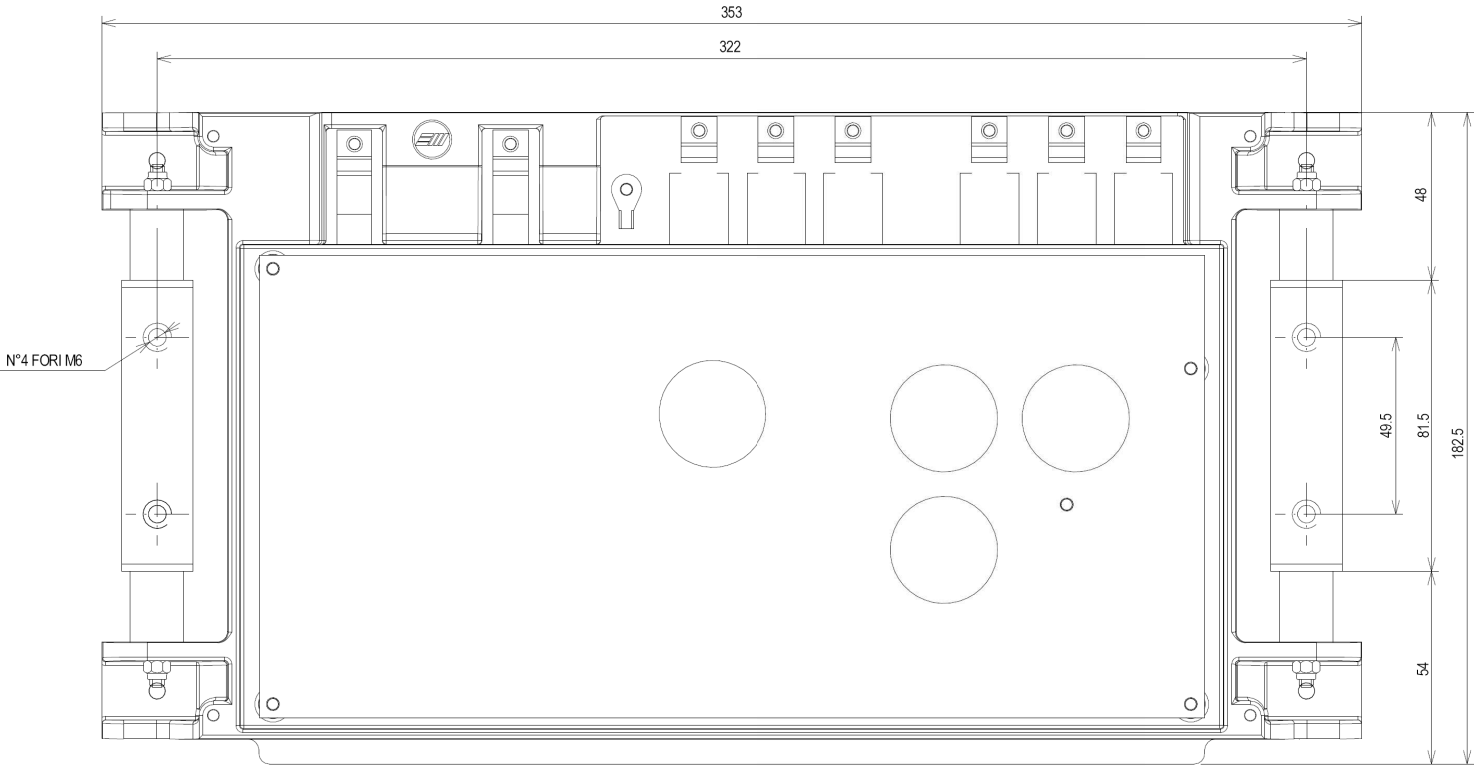
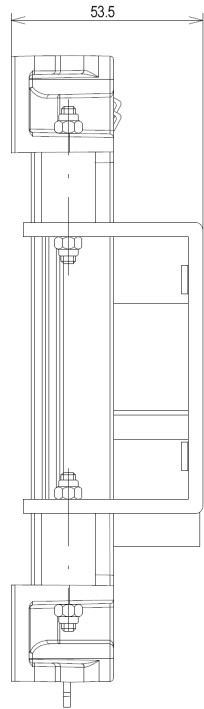

**Fig. 4.2.a**  
**MEC-100, Fastening with Vibration Dampers**

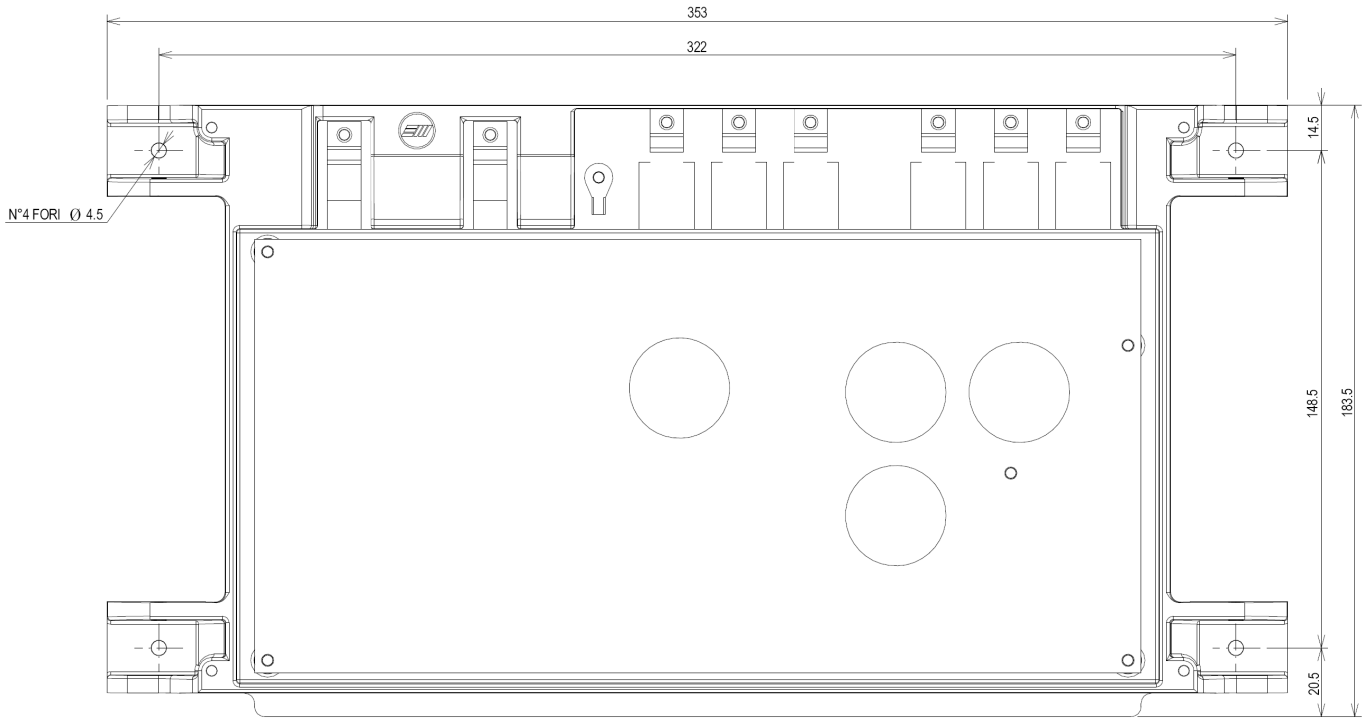
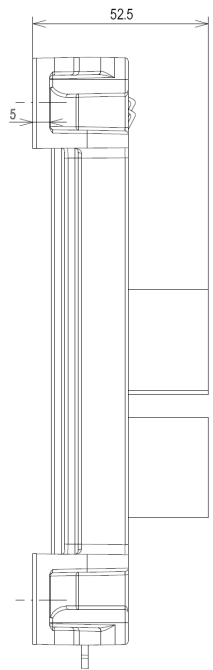
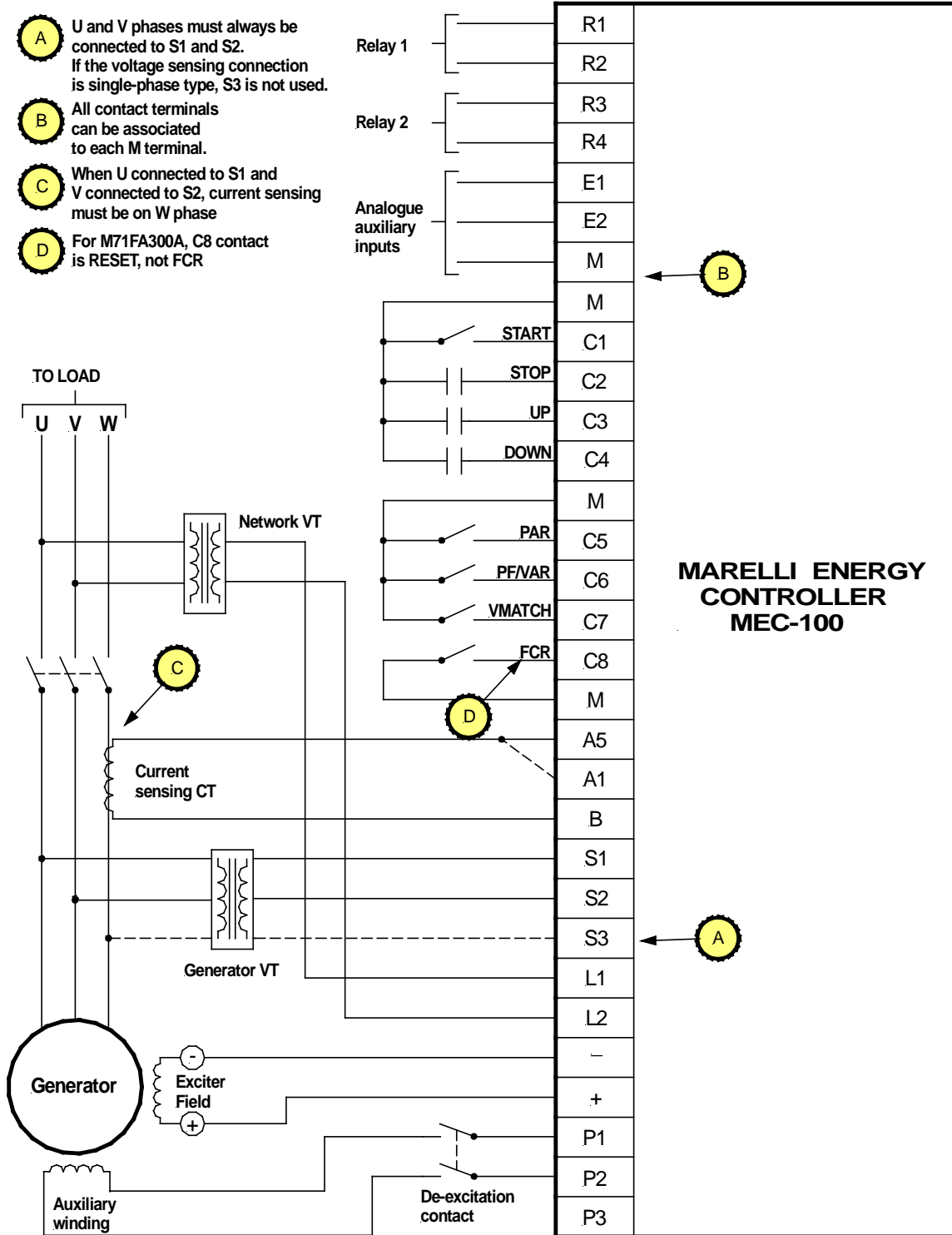

**Fig. 4.2.b**  
**MEC-100, Standard Fastening**

4.5. CONNECTIONS (TYPICAL)

4.5.1. Power Supply from Auxiliary Winding

- A** U and V phases must always be connected to S1 and S2. If the voltage sensing connection is single-phase type, S3 is not used.
- B** All contact terminals can be associated to each M terminal.
- C** When U connected to S1 and V connected to S2, current sensing must be on W phase
- D** For M71FA300A, C8 contact is RESET, not FCR



4.5.2. Power Supply from PMG (Permanent Magnet Generator)

- A** U and V phases must always be connected to S1 and S2. If the voltage sensing connection is single-phase type, S3 is not used.
- B** All contact terminals can be associated to each M terminal.
- C** When U connected to S1 and V connected to S2, current sensing must be on W phase
- D** For M71FA300A, C8 contact is RESET, not FCR

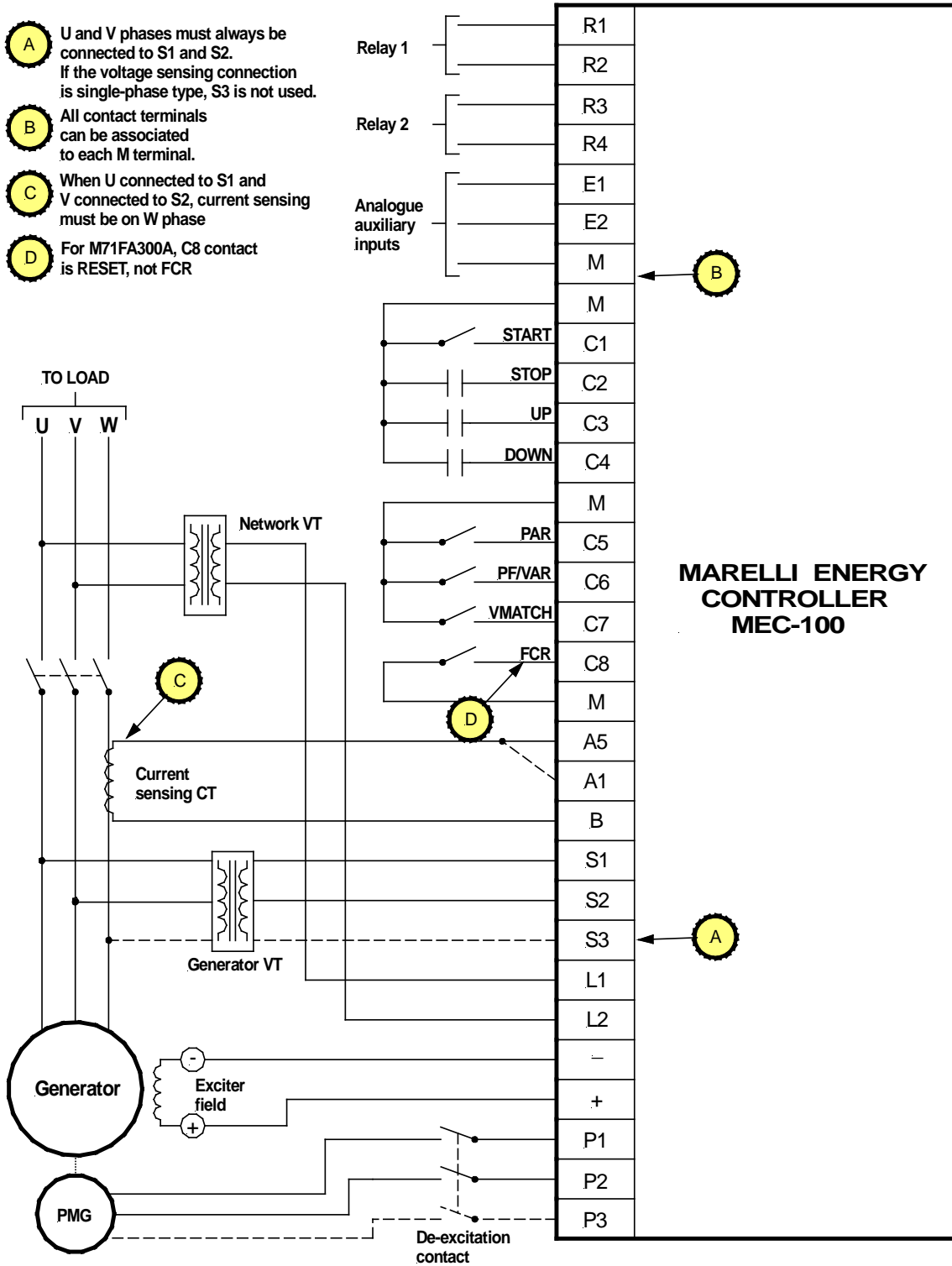

### 4.5.3. Power Supply from Main Terminals, Low Voltage

- A** U and V phases must always be connected to S1 and S2. If the voltage sensing connection is single-phase type, S3 is not used.
- B** All contact terminals can be associated to each M terminal.
- C** When U connected to S1 and V connected to S2, current sensing must be on W phase
- D** For M71FA300A, C8 contact is RESET, not FCR

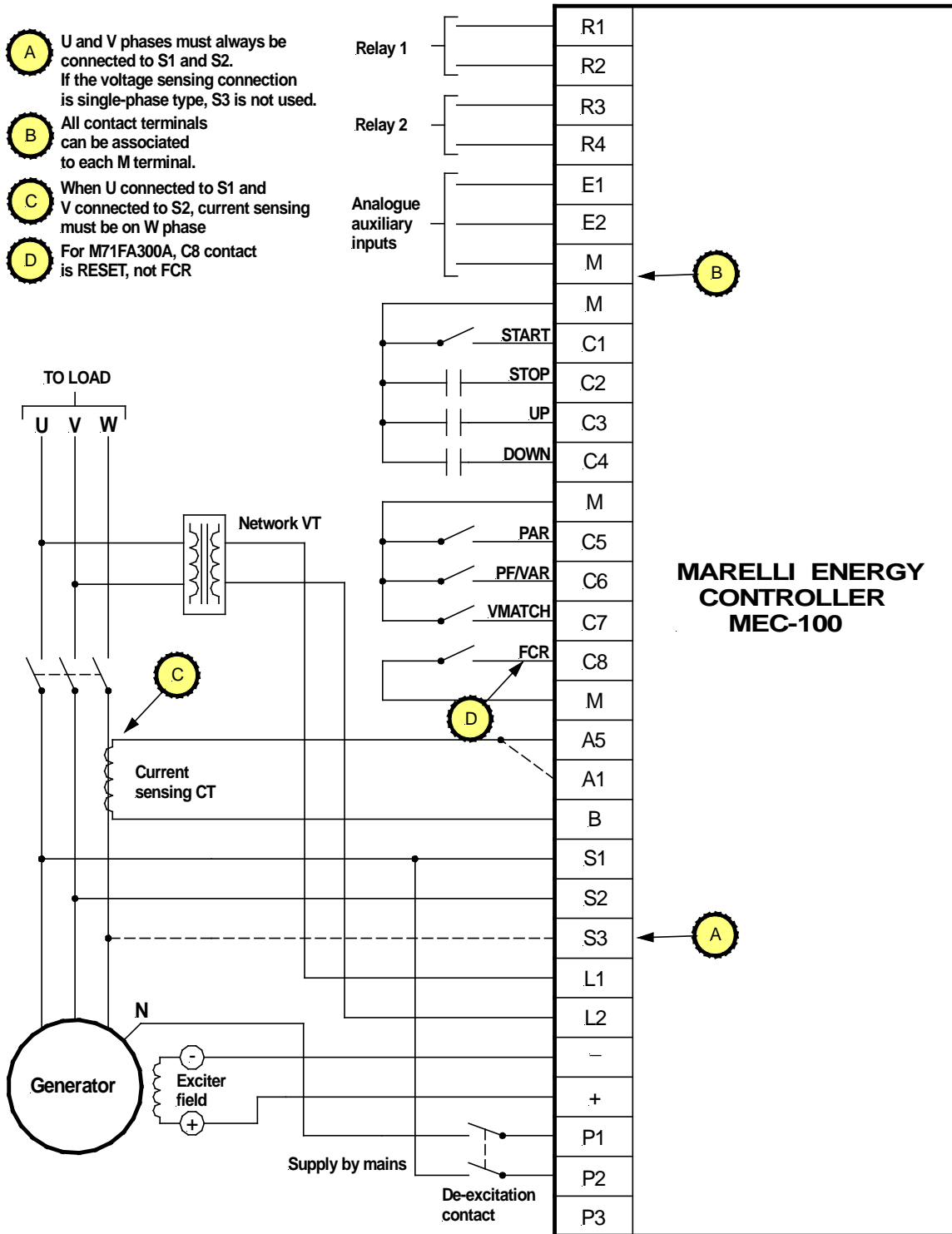

4.5.4. Power Supply from Main Terminals, Medium Voltage

- A** U and V phases must always be connected to S1 and S2. If the voltage sensing connection is single-phase type, S3 is not used.
- B** All contact terminals can be associated to each M terminal.
- C** When U connected to S1 and V connected to S2, current sensing must be on W phase
- D** For M71FA300A, C8 contact is RESET, not FCR

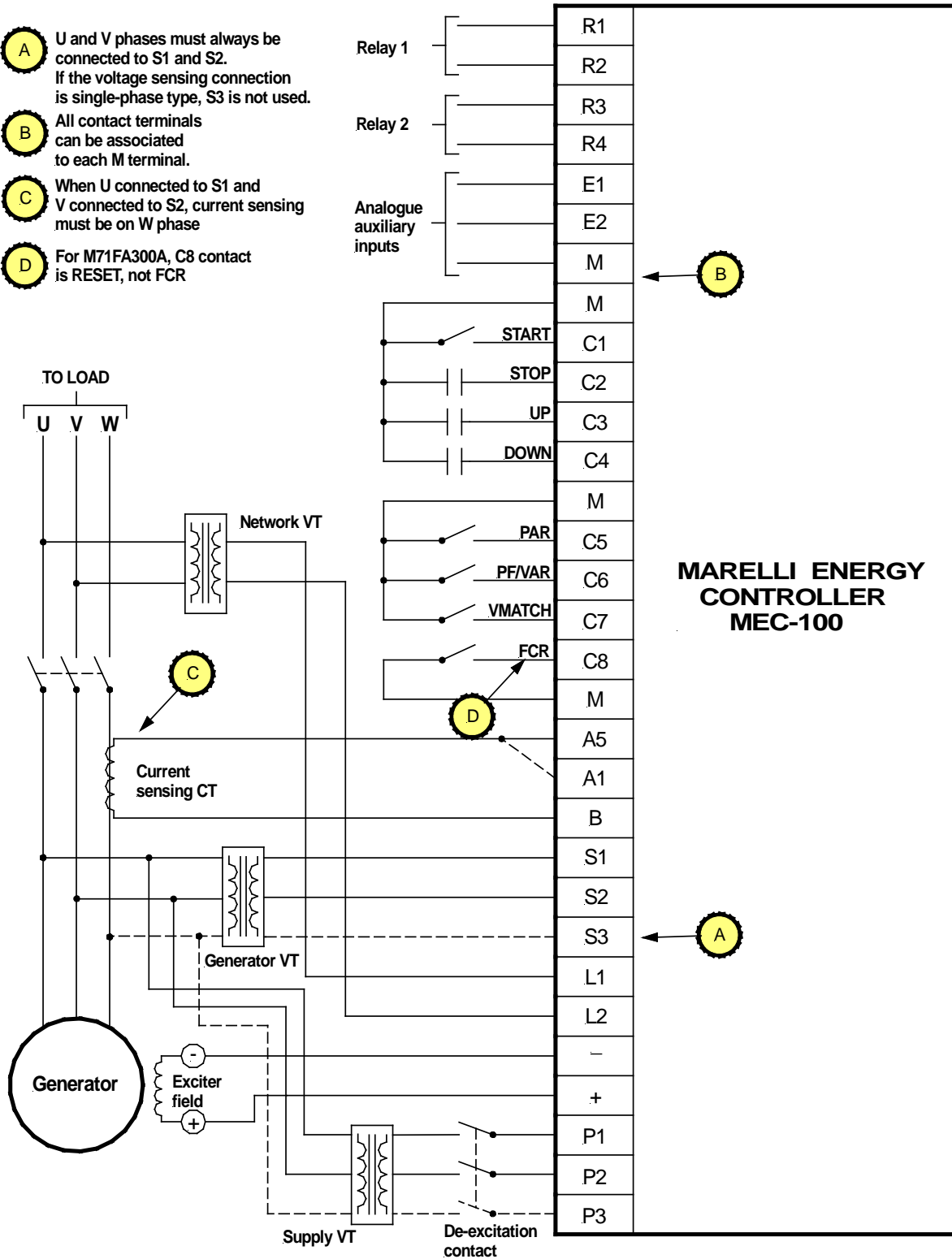



## 5. MEC-100 INTERFACE SYSTEM

### 5.1. INTRODUCTION

The MEC-100 Interface System provides an interface tool between the MEC-100 and the user capable of:

- ❖ Providing a user-friendly and intuitive working environment for the setting of the regulation system parameters.
- ❖ Displaying in real time the electrical data of the system controlled by the MEC-100.
- ❖ Allowing the system status control.
- ❖ Enabling the storage of the complete set of system parameters in the form of program files or text files.

### 5.2. INSTALLING MEC-100 INTERFACE SYSTEM

The CD-ROM provided together with the MEC-100 system includes the utility for the installation of the MEC-100 Interface System software and the user and maintenance manuals (User Manual) of the regulation system.

#### 5.2.1. Minimum System Requirements

Here below the minimum system requirements for the proper installation and utilization of the software are listed:

- ❖ PC IBM compatible, Intel® Pentium® II (300MHz or higher recommended).
- ❖ 128MB of RAM (256MB or more recommended).
- ❖ Microsoft Windows® 95, 98, Me, 2000, XP, Vista.
- ❖ CD-ROM drive.
- ❖ RS-232 Serial port or USB port.

#### 5.2.2. Installing the MEC-100 Interface System



TO DO:

To install the MEC-100 Interface System in the PC you must:

- ❖ Insert the CD-ROM disk provided with the MEC-100 into the PC CD-ROM drive.
- ❖ When the installation menu appears, click the *Install* button; the set-up utility of the MEC-100 Interface System will install automatically the software.
- ❖ Follow the instructions which appear on the PC screen.

#### 5.2.3. Starting the Program



TO DO:

To start the MEC-100 Interface System you must:

- ❖ Click the Windows® *Start* button.
- ❖ Select *Programs*.
- ❖ Point to the *MarelliMotori* directory.
- ❖ Select the *MEC-100 Interface System* icon.
- ❖ Follow the instructions which appear in the start menu.

### 5.2.4. Uninstalling the MEC-100 Interface System



TO DO:

To uninstall the MEC-100 Interface System from your PC you must:

- ❖ Open the Windows® File Manager.
- ❖ Select the MEC-100 Interface System installation folder.
- ❖ Double click on *unins000.exe* file.
- ❖ Follow the instructions which appear on the PC screen.

### 5.2.5. Connection Between MEC-100 and PC

Connect a serial communication cable to the MEC-100 RS-232 connector and to the relevant PC communication port. The MEC-100 RS-232 connector is located in the top of the device (see Par. 4.3).

## 5.3. START-UP

### 5.3.1. Acceptance of the General Contract Conditions

To start the MEC-100 Interface System follow the instructions provided in Par. 5.2.3.

At the start-up a presentation window (see Fig. 5.3.1.a), will be displayed with indication of the software version and the request for acceptance of the general contract conditions.



Fig. 5.3.1.a  
Start-up Window



To start the MEC-100 Interface System you must select *I accept the contract terms* and then click on the *Next* button.



**READ CAREFULLY THE GENERAL CONTRACT CONDITIONS.**  
Perform the above-mentioned operations to start the program involves the **SIGNING** and **FULL ACCEPTANCE** by the user of the there described terms and conditions.

### 5.3.2. Description of the Work Window

After starting the MEC-100 Interface System as described in Par. 5.2.3 e 5.3.1, the work window for the configuration and monitoring of the regulation system parameters appears. In Fig. 5.3.2.a. the displayed screen is shown.

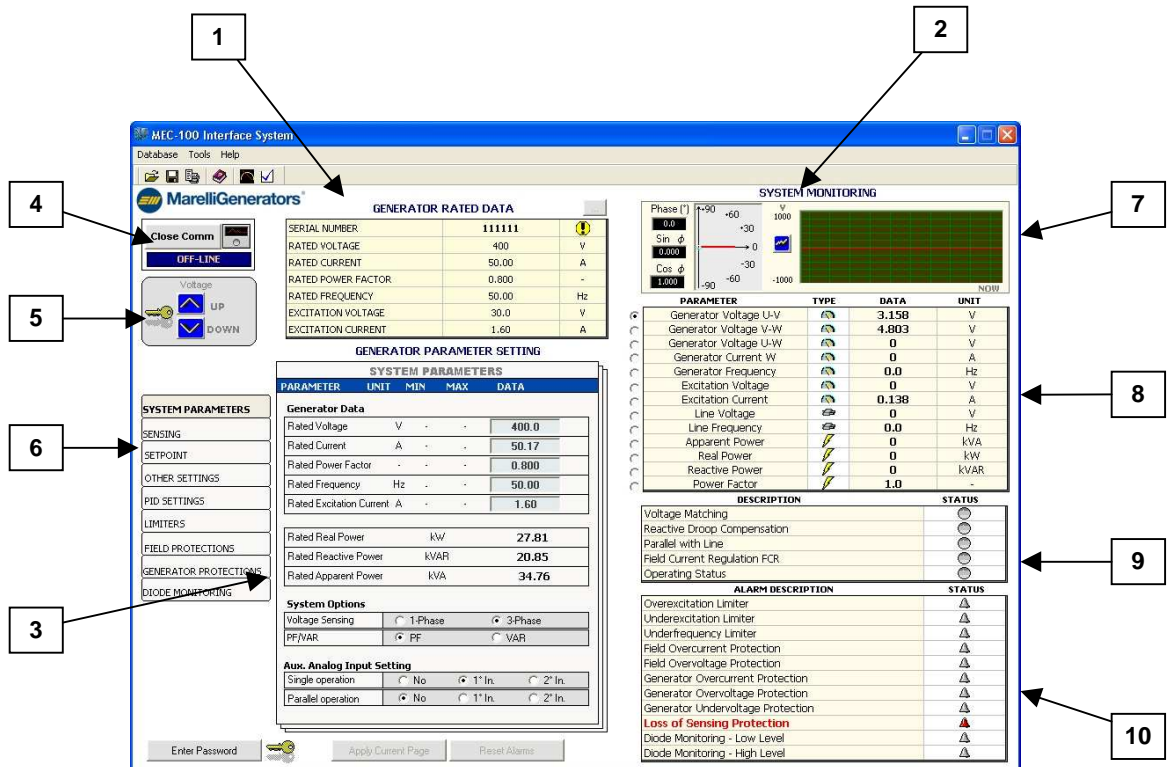

The screenshot shows the MEC-100 Interface System Work Window. The interface is divided into several sections:

- 1:** Generator Rated Data table.
- 2:** System Monitoring area, including a phase plot and a parameter table.
- 3:** System Parameters Setting area, including a table of generator data and system options.
- 4:** Close Comm button.
- 5:** OFF-LINE button.
- 6:** SYSTEM PARAMETERS menu.
- 7:** Phase plot area.
- 8:** Parameter table.
- 9:** Alarm Description table.
- 10:** Diode Monitoring section.

PARAMETER	UNIT	DATA
SERIAL NUMBER		111111
RATED VOLTAGE	V	400
RATED CURRENT	A	50.00
RATED POWER FACTOR	-	0.800
RATED FREQUENCY	Hz	50.00
EXCITATION VOLTAGE	V	30.0
EXCITATION CURRENT	A	1.60

PARAMETER	UNIT	MIN	MAX	DATA
Rated Voltage	V	-	-	400.0
Rated Current	A	-	-	50.17
Rated Power Factor	-	-	-	0.800
Rated Frequency	Hz	-	-	50.00
Rated Excitation Current	A	-	-	1.60
Rated Real Power	kW	-	-	27.81
Rated Reactive Power	kVAR	-	-	20.85
Rated Apparent Power	KVA	-	-	34.76

PARAMETER	TYPE	DATA	UNIT
Generator Voltage U-V		3.158	V
Generator Voltage V-W		4.803	V
Generator Voltage U-W		0	V
Generator Current W		0	A
Generator Frequency		0.0	Hz
Excitation Voltage		0	V
Excitation Current		0.138	A
Line Voltage		0	V
Line Frequency		0.0	Hz
Apparent Power		0	kVA
Real Power		0	kW
Reactive Power		0	kVAR
Power Factor		1.0	-

DESCRIPTION	STATUS
Voltage Matching	○
Reactive Droop Compensation	○
Parallel with Line	○
Field Current Regulation FCR	○
Operating Status	○
Overexcitation Limiter	△
Underexcitation Limiter	△
Underfrequency Limiter	△
Field Overcurrent Protection	△
Field Overvoltage Protection	△
Generator Overcurrent Protection	△
Generator Overvoltage Protection	△
Generator Undervoltage Protection	△
Loss of Sensing Protection	△
Diode Monitoring - Low Level	△
Diode Monitoring - High Level	△

**Fig. 5.3.2.a**  
**MEC-100 Interface System Work Window**

The Work Window is composed of the following sections:

1. *Rating data area*: shows the generator rating data. It does not contain operating data, but only the indications which identify the machine the MEC-100 has been configured for.
2. *System monitoring area*: displays in real time the values relative to the electrical system data, the status of contacts and alarms.
3. *Generator parameter area*: set of pages dedicated to the system configuration. It includes the fields where to assign the appropriate values to all parameters involved in the system configuration. The parameters are grouped by type in 9 Categories (system data, sensing, setpoints and other settings, stability, limitation parameters, protections, field and generator, diode monitoring).

4. *MEC-100-PC communication area*: area for the management of the communication between MEC-100 and PC. It shows in real time the communication status.
5. *Setpoint variation buttons*: tools for the modification of the controlled quantity setpoint (voltage, power factor or reactive power depending on the actual operating mode).
6. *Group selection area*: frame to select the desired configuration window.
7. *Oscillographic tracing of a system quantity*.
8. *Electrical system parameter monitoring*.
9. *System status window*.
10. *Alarm window*.

### 5.3.3. Establishing a Communication Link

Before configuring or monitoring the regulation system parameters you must establish a communication link between MEC-100 and MEC-100 Interface System.



TO DO:

To establish a communication link between MEC-100 and MEC-100 Interface System you must:

- ❖ Verify that the connection between MEC-100 and Personal Computer has been established as described in Par. 5.2.5.
- ❖ Start the MEC-100 Interface System software as described in Par. 5.3.1
- ❖ Click on the *Open Comm* button as shown in Fig. 5.3.3.a.



**Fig. 5.3.3.a**  
**Connection Button**



TO DO:

To select a PC communication port other than the default, execute the following operations:

- ❖ Click on the *Tools* item in the menu bar of the MEC-100 Interface System (see Fig. 5.3.3.b).
- ❖ In the displayed pull-down menu, select the *Port Configuration* item.
- ❖ A window (see Fig. 5.3.3.c) appears where the desired communication port can be selected.

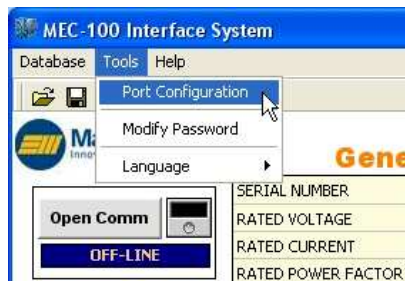

**Fig. 5.3.3.b**  
**Communication Port Setting**

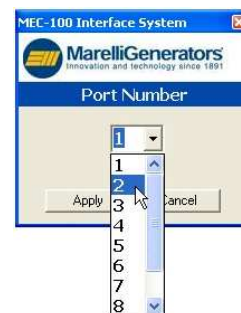

**Fig. 5.3.3.c**  
**Communication Port Selection**

After establishing the connection, the MEC-100 Interface System configuration parameters, initially set to zero by default, are automatically updated to the values saved in the MEC-100; these last can correspond to the default values, if the regulator is set for the first time, or to those stored in the E<sup>2</sup>PROM in case of previously performed configuration operations.



*The communication initialization and the update of the regulation system parameters may take a few seconds. In view of the correct execution of such operations, it is recommended to wait until they are completed before entering any data.*



*It is possible to set the MEC-100 regulation parameters only if MEC-100 is properly supplied, as described in Par. 2.1. For preliminary set-up, see Par. 7.2.*

## 5.4. PASSWORD MANAGEMENT

After starting the MEC-100 Interface System and establishing the connection, the *System Monitoring* section is operative and shows the value of the regulation system electrical quantities on a real-time basis. In the *System Parameters* section the values of the system parameters stored in the MEC-100 are displayed: they can correspond to the default values in case of first configuration or to those saved during a previous configuration operation.

Immediately after establishing the connection to the MEC-100 or after 5 minutes from the last use of the MEC-100 Interface System, the *System Parameters* section appears to be write-protected: it is therefore necessary to remove the write protection by entering a password.

Here below the password management modes for the MEC-100 Interface System are described.

### 5.4.1. Entering Password



TO DO:

To remove the write protection of the MEC-100 Interface System and enter the password:

- ❖ Click on the *Enter Password* button, placed at the left bottom of the main screen, see Fig. 5.4.1.a.
- ❖ Enter the password in the field of the displayed window (see Fig. 5.4.1.b).
- The default password is "Marelli".
- ❖ Click *Apply*.



**Fig. 5.4.1.a**  
**Enter Password Button**

### 5.4.2. Changing Password



TO DO:

To modify the password:

- ❖ Click on the *Tools* item in the menu bar of the MEC-100 Interface System (see Fig. 5.4.2.a).
- ❖ In the displayed pull-down menu, point to the *Modify Password* item and click.
- ❖ In the window which appears enter the current password in the *Previous Password* field and the desired password in the *New Password* field; afterwards enter the desired new password again for confirmation in the *Confirm Password* field (see Fig. 5.4.2.b).
- ❖ Click *OK*.



**Fig. 5.4.1.b**  
**Password Entry**

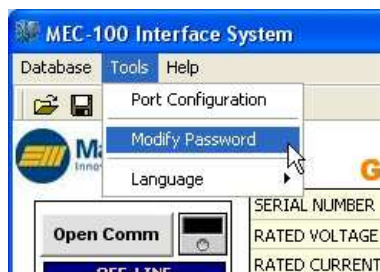

**Fig. 5.4.2.a**  
**Change Password Selection**



**Fig. 5.4.2.b**  
**Modify Password**

### 5.5. CHANGING THE SYSTEM SETTINGS

As anticipated in Par. 5.3.2, the system parameters are grouped into eight main categories according to their typology:

- ❖ *System parameters.*
- ❖ *Sensing.*
- ❖ *Setpoint.*
- ❖ *Stability.*
- ❖ *Other settings.*
- ❖ *Limiters.*
- ❖ *Field protections.*
- ❖ *Generator protections.*
- ❖ *Diode monitoring.*

Each category can be selected by the relevant button in the frame indicated with 6 in Fig. 5.3.2.a. After selecting one of the categories, the corresponding set of parameters is displayed.

If connected to the MEC-100 (see Par. 5.3.3), the above-mentioned set of parameters can also be configured. A parameter can be configured by clicking in the appropriate field and typing the desired value or selecting the desired option.

In any field you can only enter values falling within determined limits, established on the basis of the parameter type, the particular application and the other set parameters. The limits are normally indicated next to the name of the parameter to be configured. If you try to enter a value outside the allowed range a red exclamation mark will appear next to the entered item.

After configuring a group of parameters, you need to send the entered data to the MEC-100 before switching to the next group; otherwise, the typed data will be lost.



**TO DO:**

To configure the MEC-100, that is to enter the desired values for the system parameters, you must:

- ❖ Connect to the MEC-100 (see Par. 5.3.3).
- ❖ Enter la password if required (see Par. 5.4.1).
- ❖ Select the desired group of data (see Fig. 5.5.a).
- ❖ Click in the field to modify and enter the desired value. Repeat the operation for each parameter to be configured (see Fig. 5.5.b).
- ❖ As soon as all parameters into the group are set, click the *Apply Current Page* button, located under the configuration area (see Fig. 5.5.c).

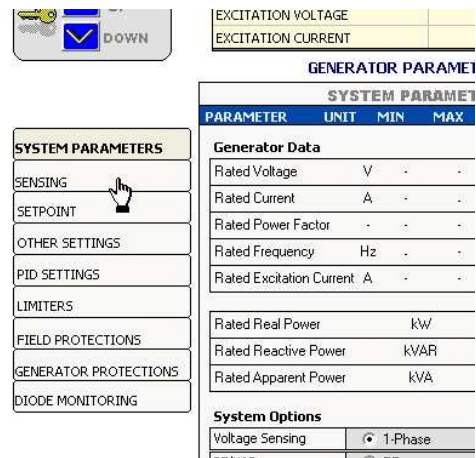

**Fig. 5.5.a**  
Parameter Group Selection

Generator Data			
Rated Voltage	V	-	40
Rated Current	A	-	50,00
Rated Power Factor	-	-	1,000
Rated Frequency	Hz	-	50,00

**Fig. 5.5.b**  
Typing Parameters

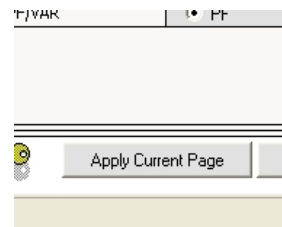

**Fig. 5.5.c**  
Button for Sending Data to the MEC-100

## 5.6. SAVING AND RETRIEVING A SET OF PARAMETERS

The MEC-100 offers the possibility of saving in a file the full set of system parameters to retrieve and load this last later in the same MEC-100 or in another unit.

### 5.6.1. Saving a Set of Parameters



TO DO:

To save a full set of system parameters:

- ❖ Connect to the MEC-100 (see Par. 5.3.3).
- ❖ Enter the password if required (see Par. 5.4.1).
- ❖ Configure all the parameters to be set (see Par. 5.5).
- ❖ Click the *Database* button in the menu bar of the MEC-100 Interface System (see Fig. 5.6.1.a).
- ❖ In the displayed pull-down menu, point to the *Save Parameter File On-line* item and click.
- ❖ In the File Manager window, select a directory where to save the file, type the file name and click on *OK*.

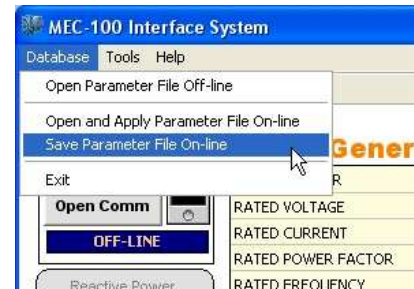

**Fig. 5.6.1.a**  
Saving a Configuration Set

### 5.6.2. Loading a Set of Parameters



TO DO:

To load a full set of system parameters:

- ❖ Connect to the MEC-100 (see Par. 5.3.3).
- ❖ Enter the password if required (see Par. 5.4.1).
- ❖ Click the *Database* button in the menu bar of the MEC-100 Interface System (see Fig. 5.6.2.a).
- ❖ In the displayed pull-down menu, point to the *Open and Apply Parameter File On-line* item and click.
- ❖ In the File Manager window, select the directory where the file to load is stored, select it and click on *OK*.

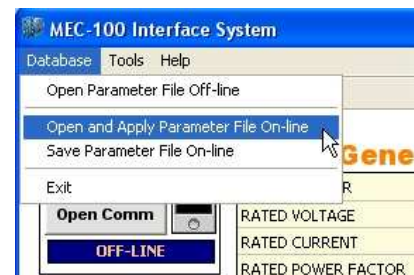

**Fig. 5.6.2.a**  
Loading a Configuration Set



*This operation is possible only if the MEC-100 and the PC are communicating (On-line operating mode). To check a parameter file without automatic applying to MEC-100, see Par. 5.6.3.*



**BE CAREFUL TO APPLY A CONFIGURATION SET TO THE MEC-100 WHEN THIS LAST IS COMMUNICATING WITH THE OPERATING GENERATOR.**

Perform the above-mentioned operations to apply a configuration set to the MEC-100 regulating the generator, involves a regulation setting alteration; it could be dangerous if the system parameters are not properly set for the application. Marelli Motori is under no liability for any damages which may occur to the AVR, the plant or the persons, or for lost earnings, or financial loss, or system stoppages, due to a not allowed setting of the MEC-100.

IT IS ALWAYS ADVISABLE TO LOAD A NEW CONFIGURATION FILE WHEN THE MEC-100 IS NOT REGULATING THE GENERATOR (SEE SECTION 6).

### 5.6.3. Checking a Set of Parameters Off-line



TO DO:

To check a whole set of parameters without applying to MEC-100:

- ❖ Interrupt the connection to the MEC-100 ( see Par. 5.3.3).
- ❖ Click the *Database* button in the menu bar of the MEC-100 Interface System (see Fig. 5.6.3.a).
- ❖ In the displayed pull-down menu, point to the *Open Parameter File Off-line* item and click.
- ❖ In the File Manager window, select the directory where the file to load is stored, select it and click on *OK*.

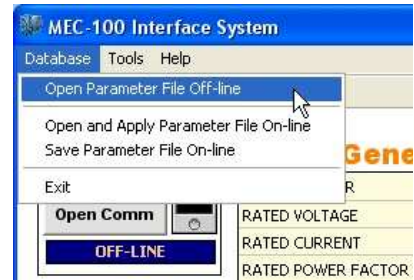

**Fig. 5.6.3.a**  
Opening a Configuration Set Off-line



*This operation only allows to check the configuration file: it is not possible to save a new configuration file in Off-line operating mode. In order to modify a parameter set previously stored, please follow the instructions of Par. 5.5 e 5.6.1.*

### 5.6.4. Printing a Set of Parameters



TO DO:

To print a whole set of parameters:

- ❖ Connect to the MEC-100 (see Par. 5.3.3) if required.
- ❖ Enter the password if required (see Par. 5.4.1).
- ❖ Click the button shown in Fig. 5.6.4.a. A new window will appear (see Fig. 5.6.4.b).
- ❖ Type the required data and click the button *Preview*. A preview of the parameter list will appear.
- ❖ To print it, click the button shown in Fig. 5.6.4.c.



**Fig. 5.6.4.a**  
Print function selection

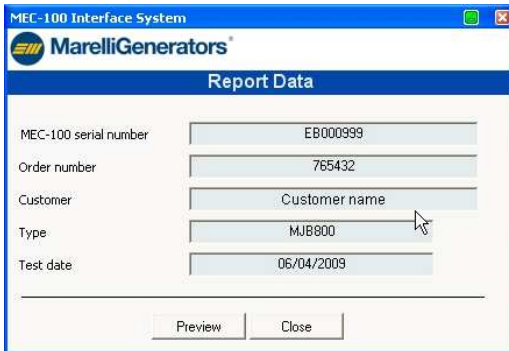

**Fig. 5.6.4.b**  
Print data typing

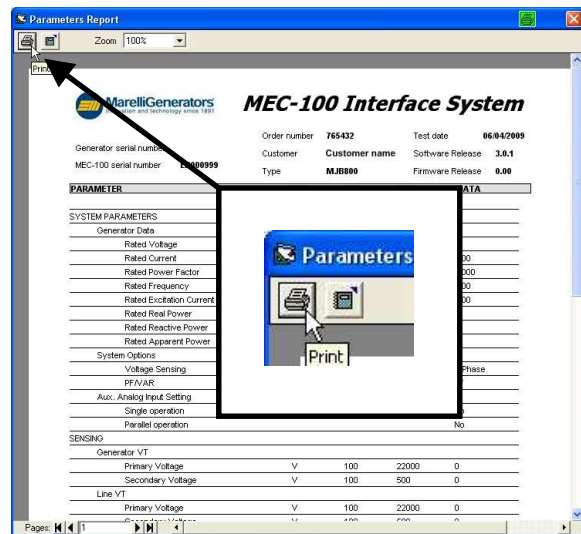

**Fig. 5.6.4.c**  
Print



## 5.7. DEFINITION OF CONFIGURABLE PARAMETERS

Each one of the 9 parameter categories is characterized by its own window, which includes as many configurable fields as many parameters are here considered and contained. Each field is generally characterized by:

- ❖ *Parameter name.*
- ❖ *Unit of measurement.*
- ❖ *Maximum and minimum entry limits.*
- ❖ *Entered parameter.*



At the moment of the first configuration operation, each field includes a default value which prevents the MEC-100 from malfunctions or damages. **ALL PROTECTIONS AND LIMITATIONS ARE DISABLED.**

Here below a description of the configurable fields is provided: they are divided based on the group they belong to.

### Key:

- Numeric value entry.*
- Value calculated, measured and/or displayed by MEC-100 Interface System.*
- Choosing one option leads to the exclusion of the other options.*
- Enabling flag.*
- Pull-down menu option.*

### 5.7.1. System Parameters

In Fig. 5.7.1.a the system parameters configuration area is shown.

SYSTEM PARAMETERS				
PARAMETER	UNIT	MIN	MAX	DATA
<b>Generator Data</b>				
Rated Voltage	V	-	-	400.0
Rated Current	A	-	-	50.17
Rated Power Factor	-	-	-	0.800
Rated Frequency	Hz	-	-	50.00
Rated Excitation Current	A	-	-	1.60
Rated Real Power			kW	27.81
Rated Reactive Power			kVAR	20.85
Rated Apparent Power			kVA	34.76
<b>System Options</b>				
Voltage Sensing		<input type="radio"/> 1-Phase	<input checked="" type="radio"/> 3-Phase	
PF/VAR		<input checked="" type="radio"/> PF	<input type="radio"/> VAR	
<b>Aux. Analog Input Setting</b>				
Single operation		<input type="radio"/> No	<input checked="" type="radio"/> 1° In.	<input type="radio"/> 2° In.
Parallel operation		<input checked="" type="radio"/> No	<input type="radio"/> 1° In.	<input type="radio"/> 2° In.

**Fig. 5.7.1.a**  
System Parameter Area

Three sets of parameters can be identified:

#### Generator Electrical Data

- Rated Voltage (V)*: enter in this field the generator rated voltage value (phase-phase).
- Rated Current (A)*: enter in this field the generator rated current value.
- Rated Power Factor*: enter in this field the generator rated power factor value.
- Rated Frequency (Hz)*: enter in this field the generator rated frequency value.
- Rated Excitation Current (A)*: enter in this field the generator rated excitation current value.
- Rated Real Power (kW)*: based on the data entered in the previous fields, the MEC-100 Interface System calculates the generator rated real power value.
- Rated Reactive Power (kvar)*: based on the data entered in the previous fields, the MEC-100 Interface System calculates the generator rated reactive power value.
- Rated Apparent Power (kVA)*: based on the data entered in the previous fields, the MEC-100 Interface System calculates the generator rated apparent power value.

#### System Options

- Voltage Sensing*: in this field the user can define the type of sensing required by a given application: single-phase or three-phase sensing.
- PF/VAR*: network parallel mode selection field; in this field you can select which regulation mode should be used in the network parallel operations. When the *PF/VAR* contact (see Par. 3.5.6) is closed, the MEC-100 will perform the adjustment of the power factor if PF has been selected or the reactive power if VAR has been selected.

#### Aux. Analog Input Setting – Single Operation (see Par. 3.4.4):

- No*: if this option is selected, no analogue auxiliary input will be associated to the generator voltage setpoint.
- 1° In.*: if this option is selected, analogue auxiliary input 1° will be associated to the generator voltage setpoint.
- 2° In.*: if this option is selected, analogue auxiliary input 2° will be associated to the generator voltage setpoint.

Aux. Analog Input Setting – Parallel Operation (see Par. 3.4.4):

- ⊙ *No*: if this option is selected, no analogue auxiliary input will be associated to the power factor or reactive power setpoint (it depends on the Operating Mode selected in *System Parameter* area, see Par. 5.7.1).
- ⊙ *1° In.*: if this option is selected, the analogue auxiliary input 1° will be associated to the power factor or reactive power setpoint (it depends on the Operating Mode selected in *System Parameter* area, see Par. 5.7.1).
- ⊙ *2° In.*: if this option is selected, the analogue auxiliary input 2° will be associated to the power factor or reactive power setpoint (it depends on the Operating Mode selected in *System Parameter* area, see Par. 5.7.1).

## 5.7.2. Sensing

In Fig. 5.7.2.a the sensing parameters configuration area is shown.

SENSING				
PARAMETER	UNIT	MIN	MAX	DATA
<b>Generator VT</b>				
Primary Voltage	V	100	22000	400
Secondary Voltage	V	100	500	400
<b>Line VT</b>				
Primary Voltage	V	100	22000	400
Secondary Voltage	V	100	500	400
<b>Generator CT</b>				
Primary Current	A	0	10000	50
Secondary Current	A	1	5	1 5
<b>Adjustments</b>				
Generator VT Ratio	%	95	105	100.6
Line VT Ratio	%	95	105	102.9
Generator CT Ratio	%	95	105	100.0
Phase Compensation	(°)	-20	+20	9.0
Excitation Current Measurement				116

Fig. 5.7.2.a  
Sensing Parameter Area

Four sets of parameters can be identified:

Generator VT: present in the applications with generator voltages higher than 500V, which need a step-down transformer between generator and MEC-100 sensing terminals.

- ❑ *Primary Voltage (V)*: enter in this field the primary voltage value of the TV used (100 to 22000V, with minimum increase of 1V).
- ❑ *Secondary Voltage (V)*: enter in this field the secondary voltage value of the TV used (100 to 500V, with minimum increase of 1V).



If the generator voltage value is lower than 500V, the use of a step-down transformer may not be necessary: therefore, the MEC-100 is directly connected to the mains terminals. In this case, in both the Primary and Secondary Voltage fields the same value, equal to the predefined rated value, should be entered.

Line VT: present in the applications with network (*Line*) voltages higher than 500V, which need a step-down transformer between the network and MEC-100 sensing terminals.

- ❑ *Primary Voltage (V)*: enter in this field the primary voltage value of the TV used (100 to 22000V, with minimum increase of 1V).
- ❑ *Secondary Voltage (V)*: enter in this field the secondary voltage value of the TV used (100 to 500V, with minimum increase of 1V).



If the network voltage value is lower than 500V, the use of a step-down transformer may not be necessary: therefore, the MEC-100 is directly connected to the network terminals. In this case, in both the Primary and Secondary Voltage fields the same value, equal to the predefined rated value, should be entered.

**TA generator:** makes the generator current sensing.

- ❑ **Primary Current (A):** enter in this field the primary current value of the CT used (1 to 10000A, with minimum increase of 1A).
- ⊙ **Secondary Current (A):** select in this field the secondary current value of the TA used by choosing between the two standard values: 1A and 5A.

**Calibrations:** this set of parameters allows to calibrate the MEC-100 sensing function in case of non-ideal transformation ratios; in this way the correct voltage, current and phase values are guaranteed to both the regulation and monitoring areas.

- ❑ **Generator VT Ratio (%):** if the MEC-100 Interface System senses and displays a generator voltage value higher, of a given percentage, than the actual value, you need to add this percentage to the percentage already entered in the field (100% of default), to obtain a correct and accurate sensing calibration (95 to 105%, with minimum increase of 0.1%).
- ❑ **Line VT Ratio (%):** if the MEC-100 Interface System senses and displays a network voltage value higher, of a given percentage, than the actual value, you need to add this percentage to the percentage already entered in the field (100% of default), to obtain a correct and accurate sensing calibration (95 to 105%, with minimum increase of 0.1%).
- ❑ **Generator CT Ratio (%):** if the MEC-100 Interface System senses and displays a generator current value higher, of a given percentage, than the actual value, you need to add this percentage to the percentage already entered in the field (100% of default), to obtain a correct and accurate sensing calibration (95 to 105%, with minimum increase of 0.1%).
- ❑ **Phase Compensation (degrees):** if the MEC-100 Interface System senses and displays a power factor value higher or lower than the actual value, you need to introduce a compensation angle (0° default value), to obtain a correct and accurate power factor measurement (-10° to +10°, with minimum increase of 0.1°).

### 5.7.3. Setpoint

In Fig. 5.7.3.a the setpoint configuration area is shown.

SETPOINT				
PARAMETER	UNIT	MIN	MAX	DATA
<b>Generator Voltage Setpoint</b>				
Voltage	%	70	130	100.0
Minimum	%	70	100	80.0
Maximum	%	100	130	110.0
<b>Power Factor Setpoint</b> <input checked="" type="radio"/> Inductive <input type="radio"/> Capacitive				
Power Factor	-	-	-	0.80
Leading PF	-	0.5	1	0.80
Lagging PF	-	0.5	1	0.70
<b>Reactive Power Setpoint</b>				
Reactive Power	%	-	-	0.00
Minimum	%	-50	0	-15.52
Maximum	%	0	100	32.34
<b>Excitation Current Setpoint</b>				
Excit. Current	%	-	-	19.95
Minimum	%	0	100	29.92
Maximum	%	1	120	39.89

Fig. 5.7.3.a  
Setpoint Area

Four sets of parameters can be identified:

#### Generator Voltage Setpoint:

- Voltage (%)**: enter in this field the voltage setpoint which is required at the generator output terminals, expressed in percentage with respect to the machine rated value, see Par. 5.7.1 (the maximum and minimum limits are defined in the two following fields, with minimum increase of 0.1%).
- Minimum Limit (%)**: enter in this field the minimum value which the voltage setpoint can reach, expressed in percentage with respect to the machine rated voltage, see Par. 5.7.1 (70 to 100%, with minimum increase of 1%).
- Maximum Limit (%)**: enter in this field the maximum value which the voltage setpoint can reach, expressed in percentage with respect to the machine rated voltage, see Par. 5.7.1 (100 to 130%, with minimum increase of 1%).



*If one of the two limits is modified and the actual voltage setpoint is outside the new defined range, the setpoint is automatically brought to the just modified limit value.*

#### Power Factor Setpoint:

- Power Factor Setpoint**: defines if the power factor setpoint should be inductive or capacitive.
- Power Factor**: enter in this field the power factor setpoint you like to keep (the minimum leading and minimum lagging limits are set in the following two fields; minimum increase of 0.001).
- Leading PF**: enter in this field the minimum leading value which the power factor setpoint can reach (0.5 to 1, with minimum increase of 0.01).
- Lagging PF**: enter in this field the minimum lagging value which the power factor setpoint can reach (0.5 to 1, with minimum increase of 0.01).



*If one of the two limits is modified and the current power factor setpoint is outside the new defined range, the setpoint is automatically brought to the just modified limit value.*

#### Reactive Power Setpoint:

- Reactive Power (%)**: enter in this field the reactive power setpoint you like to keep, expressed in percentage with respect to the maximum reactive power (the maximum and minimum limits are established in the following two fields, with minimum increase of 0.1%).
- Minimum Limit (%)**: enter in this field the (capacitive) minimum value which the reactive power setpoint can reach, expressed in percentage with respect to the maximum reactive power (-50% to 0%, with minimum increase of 1%).
- Maximum Limit (%)**: enter in this field the (inductive) maximum value which the reactive power setpoint can reach, expressed in percentage with respect to the maximum reactive power (0% to 100%, with minimum increase of 1%).



*By the term maximum reactive power it is meant the reactive power which can be obtained with rated voltage, rated current and power factor PF=0, that is at zero active power.*



*If one of the two limits is modified and the current reactive power setpoint is outside the new defined range, the setpoint is automatically brought to the just modified limit value.*

#### Excitation Current Setpoint:

- Reactive Power (%)**: enter in this field the excitation current setpoint you like to keep, expressed in percentage with respect to the rated excitation current (the maximum and minimum limits are established in the following two fields, with minimum increase of 1%).
- Minimum Limit (%)**: enter in this field the minimum value which the excitation current setpoint can reach, expressed in percentage with respect to the rated excitation current (0% to 100%, with minimum increase of 1%).
- Maximum Limit (%)**: enter in this field the maximum value which the excitation current setpoint can reach, expressed in percentage with respect to the rated excitation current (1% to 120%, with minimum increase of 1%).



**PAY PARTICULAR ATTENTION TO THE SELECTION AND/OR MODIFICATION OF THE SETPOINT VALUES.** The limit thresholds set by the MEC-100 Interface System to the setpoint values do not protect against the selection of setpoints which may be potentially dangerous for devices and/or installations connected to the generator. In all configuration operations of the MEC-100 Interface System, always check that the new setpoints to be entered are appropriate to the devices and/or installations connected to the generator. Marelli Motori is under no liability for any damages which may occur to the AVR, the plant or the persons, or for lost earnings, or financial loss, or system stoppages, due to a wrong setpoint setting.

### 5.7.4. Other Settings

In Fig. 5.7.4.a the configuration area relative to other functions is shown.

OTHER SETTINGS				
PARAMETER	UNIT	MIN	MAX	DATA
<b>Soft Start</b>				
Soft start time	s	1	3600	10
<b>Traverse rate</b>				
Voltage	%/s	0.1	5	1.1
Power Factor	.00/s	1	10	1
Reactive Power	%/s	0.1	5	1.9
<b>Voltage Matching</b>				
Minimum	%	90	100	100
Maximum	%	100	110	110
<b>Droop Settings</b>				
Reactive Droop	%	1	10	4.0

**Fig. 5.7.4.a**  
Other Settings Area

Four sets of parameters can be identified:

Soft Start (see Par. 3.10):

- ❑ **Soft Start Time (s):** enter in this field the time required by the voltage ramp, at the excitation Start-up, to reach the setpoint value defined in the setpoints window, see Par. 5.7.3 (0 to 3600s, with minimum increase of 1s).

Traverse rate:

- ❑ **Voltage (%/s):** enter in this field the variation speed of the generator voltage setpoint when this last is modified by means of the UP/DOWN contacts or the corresponding buttons of the MEC-100 Interface System, see Par. 5.3.2 (0.1%/s to 5%/s, with minimum increase of 0.1%/s).
- ❑ **Power Factor (hundredthsPF/s):** enter in this field the variation speed of the power factor setpoint when this last is modified by means of the UP/DOWN contacts or the corresponding buttons of the MEC-100 Interface System, see Par. 5.3.2 (1hundredthsPF/s to 10hundredthsPF/s, with minimum increase of 0.1hundredthsPF/s).
- ❑ **Reactive Power (%/s):** enter the variation speed of the reactive power setpoint when this last is modified by means of the UP/DOWN contacts or the corresponding buttons of the MEC-100 Interface System, see Par. 5.3.2 (0,1%/s to 5%/s, with minimum increase of 0.1%/s).



The traverse rate of the excitation current is fixed and kept slow by default.



**PAY PARTICULAR ATTENTION TO THE MODIFICATION OF THE SETPOINT VALUES.**

The limit thresholds set by the MEC-100 Interface System to the setpoint values do not protect against the selection of setpoints which may be potentially dangerous for devices and/or installations connected to the generator.

In all configuration operations of the MEC-100 Interface System, always check that the new setpoints to be entered are appropriate to the devices and/or installations connected to the generator.

Marelli Motori is under no liability for any damages which may occur to the AVR, the plant or the persons, or for lost earnings, or financial loss, or system stoppages, due to a wrong setpoint setting.

#### Voltage Matching:

- Minimum Limit (%)*: enter the minimum value of the network voltage range within which the voltage matching is enabled; this limit is expressed in percentage respect to the rated generator voltage (90% to 100%, with minimum increase of 1%).
- Maximum Limit (%)*: enter the minimum value of the network voltage range within which the voltage matching is enabled; this limit is expressed in percentage respect to the rated generator voltage (100% to 110%, with minimum increase of 1%).

#### Droop Settings:

- Reactive Droop (%)*: enter in this field the Droop Compensation value (%) for parallel operations (0 to 10%, with minimum increase of 0.1%).

### 5.7.5. Stability (P.I.D. Settings)

In Fig. 5.7.5.a the stability parameters configuration area is shown.

PID SETTINGS				
PARAMETER	UNIT	MIN	MAX	DATA
<b>Stability Settings</b>				
Custom Settings				Save Remove
<b>Voltage Regulation Stability</b>				
Proportional Gain				8
Integral Gain				8
Derivative Gain				8
<b>Derivative Adjustments</b>				
1 <sup>st</sup> Derivative Item: Time				80
2 <sup>nd</sup> Derivative Item: Filter				16
<b>PF/VAR Regulation Stability</b>				
Proportional Gain				8
Integral Gain				8

Fig. 5.7.5.a  
Stability Parameter Area

Four sets of parameters can be identified:

#### Stability settings:

- Custom setting*: select this item in order to set individually each one of the following fields.
- Standard setting*: each configuration set contains an entire parameter set, stored by factory or by user.

#### Voltage Regulation Stability (see Par. 3.11.1):

- Proportional Gain*: enter in this field the proportional constant value of the regulation loop.
- Integral Gain*: enter in this field the integrative constant value of the regulation loop.
- Derivative Gain*: enter in this field the derivative constant value of the regulation loop.

#### Derivative Adjustments (see Par. 3.11.2):

- 1<sup>st</sup> Derivative Term - Time*: enter in this field the parameter *Time* for derivative adjustment.
- 2<sup>nd</sup> Derivative Term - Filter*: enter in this field the parameter *Filter* for derivative adjustment.

Power Factor Regulation Stability (see Par. 3.11.3):

- Proportional Gain*: enter in this field the proportional constant value of the regulation loop.
- Integral Gain*: enter in this field the integrative constant value of the regulation loop.

### 5.7.6. Limiters

In Fig. 5.7.6.a the limitation parameters configuration area is shown.

LIMITERS				
PARAMETER	UNIT	MIN	MAX	DATA
<b>Underfrequency Limiter</b>				
Corner Frequency	Hz	40	60	45,0
Zero Volt Frequency	Hz	0	40	10,0
<input type="checkbox"/> Enable Limiter				
<b>Overexcitation Limiter</b>				
Maximum Current	A	0	25	10,0
Time Delay	s	0	600	3
Max. Continuative Current	A	0	15	5,0
<input type="checkbox"/> Enable Limiter <input type="checkbox"/> Apply to Relay1 <input type="checkbox"/> Apply to Relay2				
<b>Underexcitation Limiter (% of Rated Apparent Power)</b>				
Leading Power at PF=0	%	0	60	50
<input type="checkbox"/> Enable Limiter <input type="checkbox"/> Apply to Relay1 <input type="checkbox"/> Apply to Relay2				

**Fig. 5.7.6.a**  
Limitation Parameter Area

Three sets of parameters can be identified:

Underfrequency Limiter (see Par. 3.7.1):

- Corner frequency (Hz)*: enter in this field the corner frequency value in the under-frequency voltage limitation curve (40 to 60Hz, with minimum increase of 0.1Hz).
- Zero Volt Frequency (Hz)*: enter in this field the zero Volt frequency value in the under-frequency voltage limitation curve (0 to 40Hz, with minimum increase of 0.1Hz).

Overexcitation Limiter (see Par. 3.7.2):

- Maximum Current (A)*: enter in this field the maximum allowed current level value (0 to 25A, with minimum increase of 0.1A).
- Time Delay (s)*: enter in this field the minimum operation time value during which the MEC-100 is authorized to supply the *Maximum* excitation *Current* (0 to 600s, with minimum increase of 1s).
- Max. Continuative Current (A)*: enter in this field the maximum continuative current level value (0 to 15A, with minimum increase of 0.1A).

- Enable Limiter*: limiter activation flag; click on this button to activate the over-excitation limitation function.
- Apply to Relay 1*: relay 1 assignment flag; click on this button to assign the limitation intervention signal to relay 1.
- Apply to Relay 2*: relay 2 assignment flag; click on this button to assign the limitation intervention signal to relay 2.

Underexcitation Limiter (see Par. 3.7.3):

- Leading Power at PF=0 (%)*: enter in this field the maximum allowed absorbed reactive power value, expressed in percentage with respect to the maximum reactive power (0 to 50%, with minimum increase of 1%).





By the term *maximum reactive power* it is meant the reactive power which can be obtained with rated voltage, rated current and power factor  $PF=0$ , that is at zero active power.

- Enable Limiter*: limiter activation flag; click on this button to activate the under-excitation limitation function.
- Apply to Relay 1*: relay 1 assignment flag; click on this button to assign the limitation intervention signal to relay 1.
- Apply to Relay 2*: relay 2 assignment flag; click on this button to assign the limitation intervention signal to relay 2.

### 5.7.7. Field Protections

In Fig. 5.7.7.a the field protection parameters configuration area is shown.

FIELD PROTECTIONS				
PARAMETER	UNIT	MIN	MAX	DATA
<b>Field Overcurrent</b>				
Maximum Current	A	0	15	10,0
Time Delay	s	0	10	5
<input type="checkbox"/> Enable Protection <input type="checkbox"/> Apply to Relay1 <input type="checkbox"/> Apply to Relay2				
<b>Field Overvoltage</b>				
Voltage Threshold	V	0	200	190
Time Delay	s	0	300	10
<input type="checkbox"/> Enable Protection <input type="checkbox"/> Apply to Relay1 <input type="checkbox"/> Apply to Relay2				

Fig. 5.7.7.a  
Field Protection Parameter Area

Two sets of parameters can be identified:

#### Field Overcurrent (see Par. 3.6.2):

- Maximum Current (A)*: enter in this field the maximum allowed field current level value (0 to 15A, with minimum increase of 0.1A).
- Time Delay (s)*: enter in this field the time interval value, during which the MEC-100 is authorized to supply the *Maximum Current* before the activation of the relevant protection (0 to 10s, with minimum increase of 0.1s).
- Enable Protection*: protection activation flag; click on this button to activate the field over-current protection function.
- Apply to Relay 1*: relay 1 assignment flag; click on this button to assign the protection intervention signal to relay 1.
- Apply to Relay 2*: relay 2 assignment flag; click on this button to assign the protection intervention signal to relay 2.

#### Field Overvoltage (see Par. 3.6.1):

- Voltage Threshold (V)*: enter in this field the maximum allowed field voltage level value (0 to 200V, with minimum increase of 1V).
- Time Delay (s)*: enter in this field the time interval value during which the MEC-100 is authorized to supply the *Voltage Threshold* value, before the activation of the relevant protection (0 to 10s, with minimum increase of 0.1s).

- Enable Protection*: protection activation flag; click on this button to activate the field over-voltage protection function.
- Apply to Relay 1*: relay 1 assignment flag; click on this button to assign the protection intervention signal to relay 1.
- Apply to Relay 2*: relay 2 assignment flag; click on this button to assign the protection intervention signal to relay 2.



**BY DEFAULT, PROTECTIONS ARE INITIALLY DISABLED.** Pay particular attention, when configuring the MEC-100, to the activation of all concerned protections.

### 5.7.8. Generator Protections

In Fig. 5.7.8.a the generator protection parameters configuration area is shown.

GENERATOR PROTECTIONS				
PARAMETER	UNIT	MIN	MAX	DATA
<b>Generator Overcurrent</b>				
Maximum Current	%	0	120	110
Maximum Continuative Current	%	0	110	100
Time Delay	s	0	3600	2
<input checked="" type="checkbox"/> Enable Protection <input checked="" type="checkbox"/> Apply to Relay1 <input type="checkbox"/> Apply to Relay2				
<b>Generator Overvoltage</b>				
Voltage Threshold	%	100	150	112
Time Delay	s	0	300	10
<input checked="" type="checkbox"/> Enable Protection <input checked="" type="checkbox"/> Apply to Relay1 <input type="checkbox"/> Apply to Relay2				
<b>Generator Undervoltage</b>				
Voltage Threshold	%	0	100	75
Time Delay	s	0	300	10
<input checked="" type="checkbox"/> Enable Protection <input checked="" type="checkbox"/> Apply to Relay1 <input type="checkbox"/> Apply to Relay2				
<b>Loss of Sensing</b>				
<input checked="" type="checkbox"/> Enable Protection <input checked="" type="checkbox"/> Apply to Relay1 <input type="checkbox"/> Apply to Relay2				
<input checked="" type="radio"/> Shutdown <input type="radio"/> FCR				

**Fig. 5.7.8.a**  
Generator Protection Parameter Area

Four sets of parameters can be identified:

#### Generator Overcurrent (see Par. 3.6.5):

- Maximum Current (%)*: enter in this field the maximum allowed generator current level value related to the following *Time Delay*, and expressed in percentage with respect to the generator rated current value (0 to 120%, with minimum increase of 1%).
- Time Delay (s)*: enter in this field the time interval value during which the MEC-100 is authorized to supply the *Maximum Current*, before the activation of the relevant protection (0 to 3600s, with minimum increase of 1s).
- Maximum Continuative Current (%)*: enter in this field the maximum continuous generator current value, expressed in percentage with respect to the generator rated current value (0 to 110%, with minimum increase of 1%).
- Enable Protection*: protection activation flag; click on this button to activate the generator over-current protection function.
- Apply to Relay 1*: relay 1 assignment flag; click on this button to assign the protection intervention signal to relay 1.
- Apply to Relay 2*: relay 2 assignment flag; click on this button to assign the protection intervention signal to relay 2.

Generator Overvoltage (see Par. 3.6.3):

- Voltage Threshold (%)*: enter in this field the maximum generator voltage level value which corresponds to the activation of the relevant protection. It is expressed in percentage with respect to the generator rated voltage value (100 to 150%, with minimum increase of 1%).
- Time Delay (s)*: enter in this field the time interval value during which the MEC-100 is authorized to supply a voltage higher than or equal to the *Voltage Threshold* value, before the activation of the relevant protection (0 to 300s, with minimum increase of 1s).
- Enable Protection*: protection activation flag; click on this button to activate the generator over-voltage protection function.
- Apply to Relay 1*: relay 1 assignment flag; click on this button to assign the protection intervention signal to relay 1.
- Apply to Relay 2*: relay 2 assignment flag; click on this button to assign the protection intervention signal to relay 2.

Generator Undervoltage (see Par. 3.6.4):

- Voltage Threshold (%)*: enter in this field the minimum generator voltage level value which corresponds to the activation of the relevant protection. It is expressed in percentage with respect to the generator rated voltage value (0 to 100%, with minimum increase of 1%).
- Time Delay (s)*: enter in this field the time interval value during which the MEC-100 is authorized to supply a voltage lower than or equal to the *Voltage Threshold* value, before the activation of the relevant protection (0 to 300s, with minimum increase of 1s).
- Enable Protection*: protection activation flag; click on this button to activate the generator under-voltage protection function.
- Apply to Relay 1*: relay 1 assignment flag; click on this button to assign the protection intervention signal to relay 1.
- Apply to Relay 2*: relay 2 assignment flag; click on this button to assign the protection intervention signal to relay 2.

Loss of Sensing (see Par. 3.6.6):

- Enable Protection*: protection activation flag; click on this button to activate the loss of sensing protection function.
- Apply to Relay 1*: relay 1 assignment flag; click on this button to assign the protection intervention signal to relay 1.
- Apply to Relay 2*: relay 2 assignment flag; click on this button to assign the protection intervention signal to relay 2.
- Shutdown/FCR*: protection type selection. If *Shutdown* is selected, an instantaneous de-excitation of the generator will be operated when the loss of sensing occurs, if *FCR* is selected, an instantaneous switch to FCR Mode will be operated when the loss of sensing occurs.



**BY DEFAULT, PROTECTIONS ARE INITIALLY DISABLED.** Pay particular attention, when configuring the MEC-100, to the activation of all concerned protections.

### 5.7.9. Diode Monitoring

In Fig. 5.7.9.a the diode monitoring parameters configuration area is shown.

Four sets of parameters can be identified:

Low Level (see Par. 3.6.7):

- Maximum Ripple (%)*: enter in this field the maximum allowed excitation current ripple related to the following *Time Delay*, and expressed in percentage with respect to the generator rated excitation current value (0 to 100%, with minimum increase of 1%).
- Delay (s)*: enter in this field the time interval value during which the MEC-100 is authorized to work at/over *Maximum Ripple*, before the activation of the relevant protection (0 to 100s, with minimum increase of 1s).

DIODE MONITORING DEVICE				
PARAMETER	UNIT	MIN	MAX	DATA
<b>Low Level</b>				
Maximum Ripple	%	0	100	40
Delay	s	0	100	10.0
<b>High Level</b>				
Maximum Ripple	%	0	100	100
Delay	s	0	10	5.0
<b>Protection Options</b>				
<input checked="" type="checkbox"/> Enable Monitoring <input type="checkbox"/> Enable Shutdown				
<b>Alarm Options</b>				
Low Level	<input checked="" type="checkbox"/> Apply to Relay1 <input type="checkbox"/> Apply to Relay2			
High Level	<input type="checkbox"/> Apply to Relay1 <input checked="" type="checkbox"/> Apply to Relay2			

**Fig. 5.7.9.a**  
Diode Monitoring Parameter Area

High Level (see Par. 3.6.7):

- ❑ *Maximum Ripple (%)*: enter in this field the maximum allowed excitation current ripple related to the following *Time Delay*, and expressed in percentage with respect to the generator rated excitation current value (0 to 100%, with minimum increase of 1%).
- ❑ *Delay (s)*: enter in this field the time interval value during which the MEC-100 is authorized to work at/over *Maximum Ripple*, before the activation of the relevant protection (0 to 10s, with minimum increase of 1s).

Protection Options (see Par. 3.6.7):

- Enable Monitoring*: protection activation flag; click on this button to activate the diode monitoring function.
- Enable Shutdown*: shutdown activation flag; click on this button to activate the shutdown option for *High Level* monitoring.



**SHUTDOWN OPTION CAN BE USED ONLY ASSOCIATED TO HIGH LEVEL OF FAILURE.**  
Low Level can be only associated to external annunciation.

Alarm Options (see Par. 3.6.7):

High Level:

- Apply to Relay 1*: relay 1 assignment flag; click on this button to assign the protection intervention signal to relay 1.
- Apply to Relay 2*: relay 2 assignment flag; click on this button to assign the protection intervention signal to relay 2.

Low Level:

- Apply to Relay 1*: relay 1 assignment flag; click on this button to assign the protection intervention signal to relay 1.
- Apply to Relay 2*: relay 2 assignment flag; click on this button to assign the protection intervention signal to relay 2.



**BY DEFAULT, PROTECTIONS ARE INITIALLY DISABLED.** Pay particular attention, when configuring the MEC-100, to the activation of all concerned protections.

## 5.8. SYSTEM MONITORING

The MEC-100 allows to display on a real-time basis the value taken by the main electrical system parameters and the status of inputs and outputs.







The section of the MEC-100 Interface System dedicated to the system monitoring is that identified by the label 2, as shown in Figure 5.3.2.a.

It consists of six monitoring areas, which are described here below.

### 5.8.1. Electrical System Parameters

In Fig. 5.8.1.a the system parameters monitoring area is shown.

It allows to measure in real time:

-  *The three phase-to-phase voltages.*
-  *The current in the sensed phase.*
-  *The generator electrical frequency.*
-  *Excitation current and voltage.*
-  *Network frequency and voltage.*
-  *Real, reactive and apparent powers.*
-  *The power factor.*

In the last column the units of measurement of the measured electrical parameters are defined.

















PARAMETER	TYPE	DATA	UNIT
Generator Voltage U-V		400.0	V
Generator Voltage U-W		400.0	V
Generator Voltage V-W		399.6	V
Generator Current W		0	A
Generator Frequency		50.0	Hz
Excitation Voltage		10.5	V
Excitation Current		0.659	A
Line Voltage		0	V
Line Frequency		0	Hz
Apparent Power		0	kVA
Real Power		0	kW
Reactive Power		0	kVAR
Power Factor		1.00	-

Fig. 5.8.1.a  
Electrical System Parameter Monitoring

### 5.8.2. System Status

In Fig. 5.8.2.a the system status monitoring area is shown.

It allows to display in real time:

-  *The status of the voltage matching.*
-  *The status of the generators or the network parallel.*
-  *The status of the FCR Mode.*
-  *The excitation status of the system.*

In the last column, each one of the illuminated LEDs identifies the relevant active function (see the description of contacts in Par. 3.5).







DESCRIPTION	STATUS
Voltage Matching	
Reactive Droop Compensation	
Parallel with Line	
Field Current Regulation FCR	
Operating Status	

Fig. 5.8.2.a  
System Status Monitoring

### 5.8.3. Alarm Status

In Fig. 5.8.3.a the alarm status monitoring area is shown.

It allows to display in real time:

-  *The status of the limiters.*
-  *The status of the protections.*

In the last column, each one of the illuminated LEDs identifies the relevant active alarm.

Together with the LED, also the relative description of the alarm is flashing red.











ALARM DESCRIPTION	STATUS
Overexcitation Limiter	
Underexcitation Limiter	
Underfrequency Limiter	
Field Overcurrent Protection	
Field Overvoltage Protection	
Generator Overcurrent Protection	
Generator Overvoltage Protection	
Generator Undervoltage Protection	
<b>Loss of Sensing Protection</b>	
Diode Monitoring - Low Level	
Diode Monitoring - High Level	

Fig. 5.8.3.a  
Alarm Status Monitoring

### 5.8.4. Auxiliary Parameter Display

In Fig. 5.8.4.a an image of some auxiliary system parameters is shown:

- The internal MEC-100 bus voltage.
- Analogue Auxiliary Input 1 current value (mA).
- Analogue Auxiliary Input 2 current value (mA).
- Excitation Current Ripple (%).

This graphical area can be selected or de-selected by clicking the selection flag (A indicator) as shown in Fig. 5.8.4.a.



Power Factor		1.0	-
Other parameters			
Bus Voltage		169	V
Analog Input 1		0.0	mA
Analog Input 2		0.0	mA
Excit. Current Ripple		7	%
Firmware Release	2.01	Card Type	MEC-100 DM

**Fig. 5.8.4.a**  
Auxiliary Parameter Display

### 5.8.5. Phase Graphical Display

In Fig. 5.8.5.a an image of the graphical display relative to the angle deviation between generator voltage and current is shown.

Moreover it allows to display the numerical values of:

- Phase (Degrees).
- Sin  $\phi$ .
- Cos  $\phi$ .

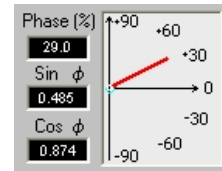

**Fig. 5.8.5.a**  
Phase Graphical Display

### 5.8.6. Oscillographic Display

In Fig. 5.8.6.a an image of the oscillographic indicator relative to the electrical system parameters is shown.

In the figure the three areas concerned by the use of these functions can be identified:

- ⊙ Selection of the electrical parameter to be displayed (A indicator in Fig. 5.8.6.a). Next to each one of the items corresponding to the measured parameters, an option button ("⊙") for the selection of the parameter to be displayed is located.

To select the parameter to be displayed, click on the option button associated to the relative item.

- Visualisation of the selected parameter in function of the time (B indicator in Fig. 5.8.6.a).

- C indicator shows the button to open the oscillographic display settings.

In the example in the Fig. 5.8.6.a, the time profile of the voltage between the U and V phases, measured during the SOFT-START phase, is shown.

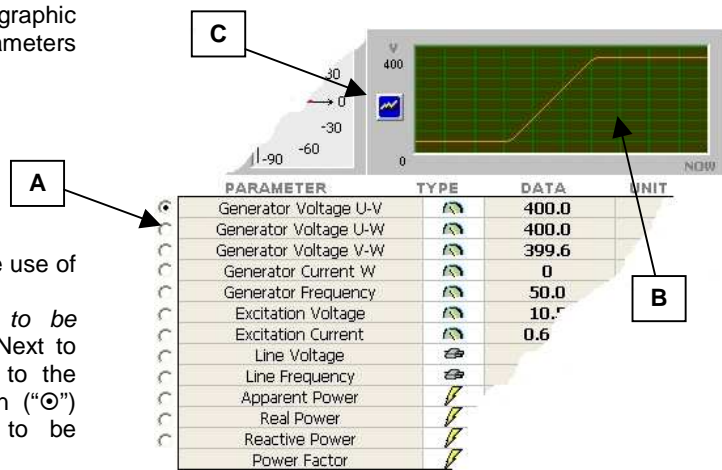

**Fig. 5.8.6.a**  
Oscillographic Display



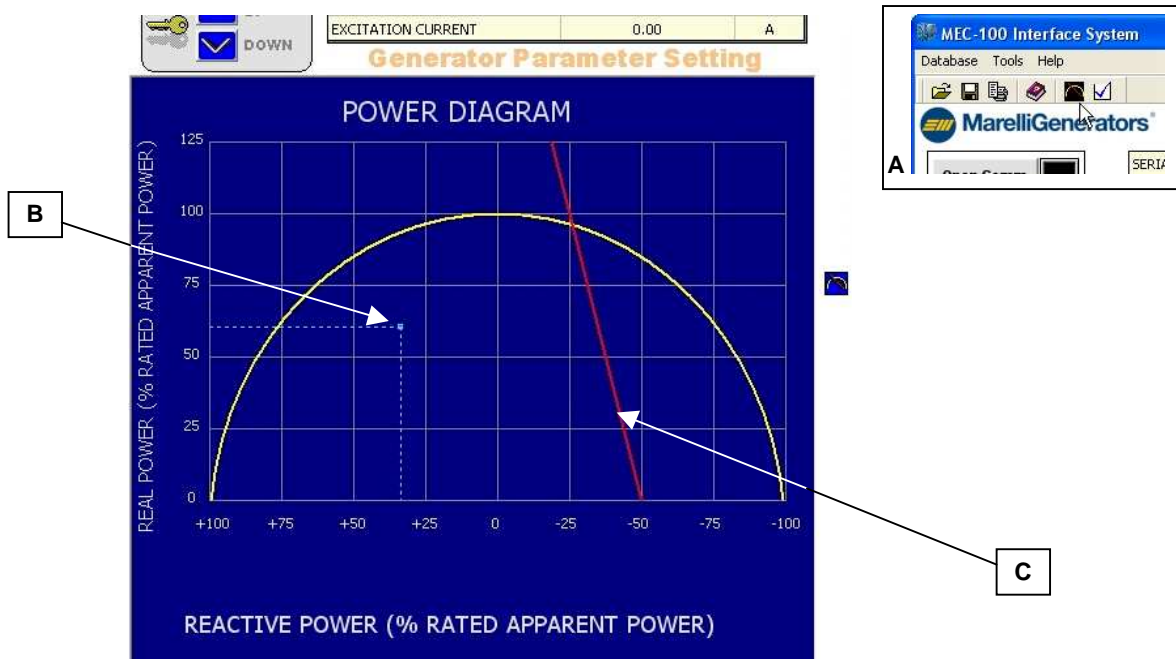

### 5.8.7. Power Diagram



**Fig. 5.8.7.a**  
Power Diagram

In Fig. 5.8.7.a an image of the power diagram is shown.

It provides in real time the generator operating point, with:

-  The instantaneous indication of active and reactive power (**B** indicator in Fig. 5.8.7.a).
-  The visualisation of the curve defined by setting the under-excitation limiter (**C** indicator in Fig. 5.8.7.a, see Par. 3.7.3).



The **A** indicator in Fig. 5.8.7.a identifies the button for the selection of the *Power Diagram* graphical display mode; by clicking on it the described diagram replaces the *System Parameters* configuration window. By clicking again on the same button, the *System Parameters* configuration window reappears.

## 6. SET-UP PROCEDURE

In this Section basic instruction for the preliminary set-up of MEC-100 by MEC-100 Interface System will be listed. Should more detailed information be necessary, please see Sections 3, 4 and 5.

### 6.1. MEC-100 INTERFACE SYSTEM INSTALLATION



TO DO:

- ❖ Insert the CD-ROM disk provided with the MEC-100 into the PC CD-ROM drive.
- ❖ When the installation menu appears, click the *Install* button; the set-up utility of the MEC-100 Interface System will install automatically the software.
- ❖ Follow the instructions which appear on the PC screen.

### 6.2. PREPARAZIONE DEL MEC-100

The MEC-100 is equipped with an RS-232 serial port located on the card component side: it consists of a DB-9 female connector. For the connection to Personal Computer (PC) a standard communication cable ending with a DB-9 female connector is required.

If the DB-9 serial port is not available on PC, one of the USB ports must be used, paying attention to:

- ❖ Interpose an USB/DB-9 adapter between the standard cable and the PC.
- ❖ Install the adapter driver files on PC (please follow the provided instructions).



TO DO:

The basic connection diagram for the preliminary MEC-100 set-up is shown in Fig. 6.2.a. The proper actions are the following (respect the shown order):

- ❖ Connect MEC-100 to PC by means of the communication cable.
- ❖ Apply the supply voltage to supply terminals P1 and P2. The proper supply voltage ranges from 30Vac to 220Vac.

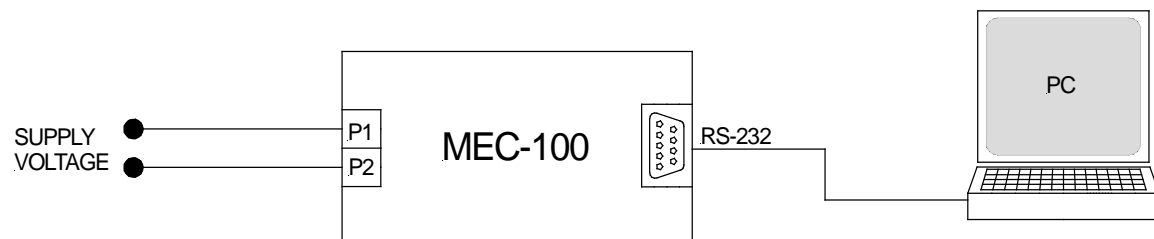





**FOR THE PRELIMINARY MEC-100 SET-UP DISCONNECT ALL THE WIRING AND SUPPLY THE CARD BY MEANS OF AN EXTERNAL POWER SOURCE.** Only the connections shown in Fig. 6.2.a can be used.



**WARNING: Before doing any operations and/or any set-up on MEC-100, is to be taken into consideration that lethal voltage is present at the top panel when the unit is energized. Top panel connections and/or operations with or without tools should be made only when the unit is de-energized.**

### 6.3. STARTING THE PROGRAM



TO DO:

- ❖ Click the Windows® *Start* button.
- ❖ Select *Programs*.
- ❖ Point to the *MarelliMotori* directory.
- ❖ Select the *MEC-100 Interface System* icon.
- ❖ Follow the instructions which appear in the start menu.

### 6.4. ESTABLISHING A COMMUNICATION LINK



TO DO:

- ❖ Click the connection button *Open Comm* mostrato in Fig. 6.4.a.
- ❖ If required, enter the generator serial number e click *OK*.
- ❖ Click *OK* to all the following messages.
- ❖ The message *ON-LINE* has to be displayed into the blue bar below.

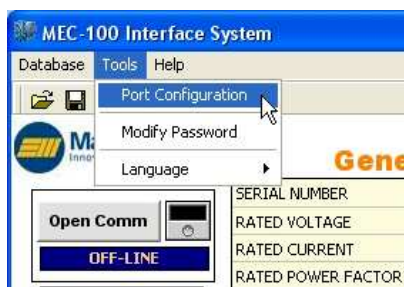

**Fig. 6.4.a**  
Connection button



To select a PC communication port other than the default, execute the following operations:

- ❖ Click on the *Tools* item in the menu bar of the MEC-100 Interface System (see Fig. 6.4.b).
- ❖ In the displayed pull-down menu, select the *Port Configuration* item.
- ❖ A window (see Fig. 6.4.c) appears where the desired communication port can be selected.



**Fig. 6.4.b**  
Communication Port Setting

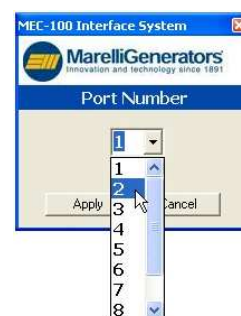

**Fig. 6.4.c**  
Communication Port Selection

### 6.5. ENTERING THE PASSWORD



TO DO:

To remove the write protection of the MEC-100 and enter the password:

- ❖ Click on the *Enter Password* button, placed at the left bottom of the main screen, see Fig. 6.5.a.
- ❖ Enter the password in the field on the displayed window (see Fig. 6.5.b).  
The default password is "Marelli".
- ❖ Click *Apply*.
- ❖ To change the password, see Par. 5.4.2.

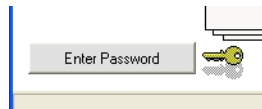

**Fig. 6.5.a**  
**Enter Password Button**



**Fig. 6.5.b**  
**Password Entry**

### 6.6. CONFIGURE THE SYSTEM SETTING



TO DO:

To carry out the complete MEC-100 set-up by means of MEC-100 Interface System, read carefully the following instructions. Remember that all parameters are divided by type in 9 groups, each group associated to a setting window. The window selection is achievable by clicking on one of the nine items of the selection frame shown in 6.6.a.

As the set-up is obtained window by window, parameters set in other windows could be not consistent with the ones just entered (high-lined red point).

Please **respect the order** of the following instructions, in order to get the total proper setup of MEC-100.

**Please check all the entered parameters before using the MEC-100.**

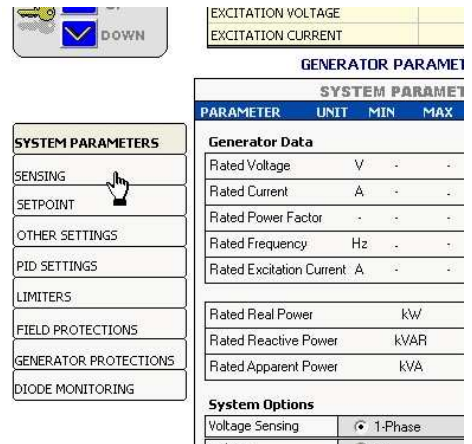

**Fig. 6.6.a**  
**Parameter Group Selection**

Sensing Window



TO DO:

- ❖ **Generator VT - Primary Voltage (V):** enter the primary voltage value of the TV used, otherwise the generator rated voltage (100 to 22000V, with minimum increase of 1V).
- ❖ **Generator VT - Secondary Voltage (V):** the secondary voltage value of the TV used, otherwise the generator rated voltage (100 to 500V, with minimum increase of 1V).
- ❖ **Line VT - Primary Voltage (V):** enter the primary voltage value of the TV used, otherwise the line/network rated voltage (100 to 22000V, with minimum increase of 1V).
- ❖ **Line VT - Secondary Voltage (V):** the secondary voltage value of the TV if used, otherwise the line/network rated voltage (100 to 500V, with minimum increase of 1V).
- ❖ **Generator CT - Primary Current (V): (A):** enter the primary current value of the CT used (1 to 10000A, with minimum increase of 1A).
- ❖ **Generator CT - Primary Current (A):** select in this field the secondary current value of the TA used by choosing between the two standard values: 1A and 5A.
- ❖ **Adjustment - Generator VT Ratio (%):** if the MEC-100 Interface System senses and displays a generator voltage value higher, of a given percentage, than the actual value, you need to add this percentage to the percentage already entered in the field (100% of default), to obtain a correct and accurate sensing calibration (95 to 105%, with minimum increase of 0.1%).
- ❖ **Adjustment - Line VT Ratio (%):** if the MEC-100 Interface System senses and displays a network voltage value higher, of a given percentage, than the actual value, you need to add this percentage to the percentage already entered in the field (100% of default), to obtain a correct and accurate sensing calibration (95 to 105%, with minimum increase of 0.1%).
- ❖ **Adjustment - Generator CT Ratio (%):** if the MEC-100 Interface System senses and displays a generator current value higher, of a given percentage, than the actual value, you need to add this percentage to the percentage already entered in the field (100% of default), to obtain a correct and accurate sensing calibration (95 to 105%, with minimum increase of 0.1%).
- ❖ **Adjustment - Phase Compensation (degrees):** if the MEC-100 Interface System senses and displays a power factor value higher or lower than the actual value, you need to introduce a compensation angle (0° default value), to obtain a correct and accurate power factor measurement (-10° to +10°, with minimum increase of 0.1°).

SENSING				
PARAMETER	UNIT	MIN	MAX	DATA
<b>Generator VT</b>				
Primary Voltage	V	100	22000	400
Secondary Voltage	V	100	500	400
<b>Line VT</b>				
Primary Voltage	V	100	22000	400
Secondary Voltage	V	100	500	400
<b>Generator CT</b>				
Primary Current	A	0	10000	50
Secondary Current	A	1	5	<input checked="" type="radio"/> 1 <input type="radio"/> 5
<b>Adjustments</b>				
Generator VT Ratio	%	95	105	100.6
Line VT Ratio	%	95	105	102.9
Generator CT Ratio	%	95	105	100.0
Phase Compensation	(°)	-20	+20	9.0
Excitation Current Measurement				116

System Parameters Window



TO DO:

- ❖ *Generator Data - Rated Voltage (V):* enter the generator rated voltage value (phase-phase).
- ❖ *Generator Data - Rated Current (A):* enter the generator rated current value.
- ❖ *Generator Data - Rated Power Factor:* enter the generator rated power factor value.
- ❖ *Generator Data - Rated Frequency (Hz):* enter the generator rated frequency value.
- ❖ *Generator Data - Rated Excitation Current (A):* enter the generator rated excitation current value.
  
- ❖ *System Options - Voltage Sensing:* select the desired sensing mode.
- ❖ *System Options - PF/VAR:* select the desired regulation mode during parallel operations.
  
- ❖ *Aux. Analog Input Setting - Single Operation:* select the analog input to which associate the setpoint during single operation.
- ❖ *Aux. Analog Input Setting - Parallel Operation:* select the analog input to which associate the setpoint during parallel operation.

SYSTEM PARAMETERS				
PARAMETER	UNIT	MIN	MAX	DATA
<b>Generator Data</b>				
Rated Voltage	V	-	-	400.0
Rated Current	A	-	-	50.17
Rated Power Factor	-	-	-	0.800
Rated Frequency	Hz	-	-	50.00
Rated Excitation Current	A	-	-	1.60
<hr/>				
Rated Real Power	kW			27.81
Rated Reactive Power	kVAR			20.85
Rated Apparent Power	kVA			34.76
<b>System Options</b>				
Voltage Sensing		<input type="radio"/> 1-Phase <input checked="" type="radio"/> 3-Phase		
PF/VAR		<input checked="" type="radio"/> PF <input type="radio"/> VAR		
<b>Aux. Analog Input Setting</b>				
Single operation		<input type="radio"/> No <input checked="" type="radio"/> 1° In. <input type="radio"/> 2° In.		
Parallel operation		<input checked="" type="radio"/> No <input type="radio"/> 1° In. <input type="radio"/> 2° In.		

The two analog input are current type, 4-0mA: for example, if voltage setpoint limits are set to 80 and 120% of the generator rated voltage, 4mA will be associated to the minimum limit (80%) and 20mA to the maximum limit (120%), and all the intermediate values of the generator voltage setpoint will proportionally correspond to the current values between 4 and 20mA.

Setpoint Window



TO DO:

- ❖ *Generator Voltage Setpoint - Voltage (%):* enter the generator voltage setpoint, expressed in percentage with respect to the machine rated value (with minimum increase of 0.1%).
- ❖ *Generator Voltage Setpoint - Minimum (%):* enter the minimum value which the voltage setpoint can reach, expressed in percentage with respect to the machine rated voltage (70 to 100%, with minimum increase of 1%).
- ❖ *Generator Voltage Setpoint - Maximum (%):* enter the maximum value which the voltage setpoint can reach, expressed in percentage with respect to the machine rated voltage (70 to 100%, with minimum increase of 1%).
  
- ❖ *Power Factor Setpoint:* Select PF type, inductive or capacitive.
- ❖ *Power Factor Setpoint - Power Factor:* enter the PF setpoint (with minimum increase of 0.001).
- ❖ *Power Factor Setpoint - Leading:* enter the minimum leading limit (0.5 to 1, with minimum increase of 0.01).
- ❖ *Power Factor Setpoint - Lagging:* enter the minimum lagging limit (0.5 to 1, with minimum increase of 0.01).

SETPOINT				
PARAMETER	UNIT	MIN	MAX	DATA
<b>Generator Voltage Setpoint</b>				
Voltage	%	70	130	100.0
Minimum	%	70	100	80.0
Maximum	%	100	130	110.0
<b>Power Factor Setpoint</b> <input checked="" type="radio"/> Inductive <input type="radio"/> Capacitive				
Power Factor	-	-	-	0.80
Leading PF	-	0.5	1	0.80
Lagging PF	-	0.5	1	0.70
<b>Reactive Power Setpoint</b>				
Reactive Power	%	-	-	0.00
Minimum	%	-50	0	-15.52
Maximum	%	0	100	32.34
<b>Excitation Current Setpoint</b>				
Excit. Current	%	-	-	19.95
Minimum	%	0	100	29.92
Maximum	%	1	120	39.89

- ❖ *Reactive Power Setpoint - Reactive Power (%)*: enter the reactive power setpoint, expressed in percentage with respect to the maximum reactive power (with minimum increase of 0.1%)
- ❖ *Reactive Power Setpoint - Minimum (%)*: enter the (capacitive) minimum value of the reactive power setpoint, expressed in percentage with respect to the maximum reactive power (-50% to 0%, with minimum increase of 1%).
- ❖ *Reactive Power Setpoint - Maximum (%)*: enter the (inductive) maximum value of the reactive power setpoint, expressed in percentage with respect to the maximum reactive power (0% to 100%, with minimum increase of 1%).
- ❖ *Excitation Current Setpoint - Excitation Current (%)*: enter the excitation current setpoint, expressed in percentage with respect to the rated excitation current (with minimum increase of 1%).
- ❖ *Excitation Current Setpoint - Minimum (%)*: enter the minimum value of the excitation current setpoint, expressed in percentage with respect to the rated excitation current (0% to 100%, with minimum increase of 1%).
- ❖ *Excitation Current Setpoint - Maximum (%)*: enter the maximum value of the excitation current setpoint, expressed in percentage with respect to the rated excitation current (1% to 120%, with minimum increase of 1%).



**PAY PARTICULAR ATTENTION TO THE SELECTION AND/OR MODIFICATION OF THE SETPOINT VALUES.** The limit thresholds set by the MEC-100 Interface System to the setpoint values do not protect against the selection of setpoints which may be potentially dangerous for devices and/or installations connected to the generator.

In all configuration operations of the MEC-100 Interface System, always check that the new setpoints to be entered are appropriate to the devices and/or installations connected to the generator. Marelli Motori is under no liability for any damages which may occur to the AVR, the plant or the persons, or for lost earnings, or financial loss, or system stoppages, due to a wrong setpoint setting.

Other Settings Window



TO DO:

- ❖ *Soft Start - Soft Start Time (s)*: enter the voltage ramp time (0 to 3600s, with minimum increase of 1s).
- ❖ *Traverse rate - Voltage (%/s)*: enter the variation speed of the generator voltage setpoint (0.1%/s to 5%/s, with minimum increase of 0.1%/s).
- ❖ *Traverse rate - Power Factor (centesimiPF/s)*: enter the variation speed of the power factor setpoint (1 hundredthsPF/s to 10 hundredthsPF/s, with minimum increase of 0.1 hundredthsPF/s).
- ❖ *Traverse rate - Reactive Power (%/s)*: enter the variation speed of the reactive power setpoint (0.1%/s to 5%/s, with minimum increase of 0.1%/s).



The traverse rate of the excitation current is fixed and kept slow by default.

- ❖ *Voltage Matching - Minimum Limit (%)*: enter the minimum value of the network voltage range within which the voltage matching is enabled; this limit is expressed in percentage respect to the rated generator voltage (90% to 100%, with minimum increase of 1%).
- ❖ *Voltage Matching - Maximum Limit (%)*: enter the minimum value of the network voltage range within which the voltage matching is enabled; this limit is expressed in percentage respect to the rated generator voltage (100% to 110%, with minimum increase of 1%).

OTHER SETTINGS				
PARAMETER	UNIT	MIN	MAX	DATA
<b>Soft Start</b>				
Soft start time	s	1	3600	10
<b>Traverse rate</b>				
Voltage	%/s	0.1	5	1.1
Power Factor	.00/s	1	10	1
Reactive Power	%/s	0.1	5	1.9
<b>Voltage Matching</b>				
Minimum	%	90	100	100
Maximum	%	100	110	110
<b>Droop Settings</b>				
Reactive Droop	%	1	10	4.0

- ❖ *Drift Settings - Reactive Drift (%)*: enter the Drift Compensation value (%) for parallel operations (0 to 10%, with minimum increase of 0.1%).

PID Setting Window



TO DO:

- ❖ *Stability Settings*: select the desired predefined standard setting or alternatively the custom setting in order to tune the parameters each one.
- ❖ *Voltage Regulation Stability - Proportional Gain*: enter the proportional constant value of the regulation loop.
- ❖ *Voltage Regulation Stability - Integral Gain*: enter the integrative constant value of the regulation loop.
- ❖ *Voltage Regulation Stability - Derivative Gain*: enter the derivative constant value of the regulation loop.
- ❖ *Derivative Adjustments - 1<sup>st</sup> Derivative Term - Time*: enter the parameter *Time* for derivative adjustment.
- ❖ *Derivative Adjustments - 2<sup>nd</sup> Derivative Term - Filter*: enter the parameter *Filter* for derivative adjustment.
- ❖ *Power Factor Regulation Stability - Proportional Gain*: enter the proportional constant value of the regulation loop.
- ❖ *Power Factor Regulation Stability - Integral Gain*: enter the parameter *Filter* for derivative adjustment.

PID SETTINGS				
PARAMETER	UNIT	MIN	MAX	DATA
<b>Stability Settings</b>				
Custom Settings				Save Remove
<b>Voltage Regulation Stability</b>				
Proportional Gain				700
Integral Gain				90
Derivative Gain				500
<b>Derivative Adjustments</b>				
1 <sup>st</sup> Derivative Item: Time				60
2 <sup>nd</sup> Derivative Item: Filter				20
<b>PF/VAR Regulation Stability</b>				
Proportional Gain				100
Integral Gain				100

PID setting advises: in case of MEC-100 without factory set-up, take the PID parameters from the following table.

Generator Type	AVR MODE					PF / VAR MODE	
	KP	KI	KD	1°d.t.	2°d.t.	KP	KI
MJB 400	1800	400	500	20	16	180	300
MJB 450	900	250	600	40	16	150	300
MJB 500	600	150	600	20	16	120	120
MJB 560	800	180	600	40	16	180	140
MJH 630	1000	150	1000	40	16	150	140
MJH 710	1100	150	1100	40	16	150	140

They are only standard parameters, not the optimum, and a subsequent tuning (step by step) is necessary to get the best PID setting for the application.

In order to tune correctly the PID parameters, enter the values shown in table 6.6.a for the proper generator frame size, and verify if they are proper for the application: if necessary, modify one by one KP, KI, KD (with this order); changes have to be lower then 10% of the actual value, and can be increasing or decreasing, depending on the generator time response.

Chosen voltage regulation PID parameters can be verified as follows:

- ❖ by applying a small load, not higher than 50% of the rated value, and measuring voltage dip and related recovery time;
- ❖ by rejecting the same load and measuring the voltage overshoot and related recovery time.

Chosen PF regulation PI parameters can be verified as follows:

- ❖ by applying a PF step value, not higher than 0.1, and measuring PF overshoot (if present) and recovery time.

Should better transient performances be required, contact the Marelli After Market Department for more information (see Section 7).



**Should the chosen PID parameters be unproper or dangerous for the application, stop the generator and contact the Marelli After Market Department (see Section 7).**

### Limiters Window



#### TO DO:

- ❖ *Underfrequency Limiter - Corner Frequency (Hz)*: enter the corner frequency value (40 to 60Hz, with minimum increase of 0.1Hz).
- ❖ *Underfrequency Limiter - Zero Volt Frequency (Hz)*: enter the zero Volt frequency value (0 to 40Hz, with minimum increase of 0.1Hz).
- ❖ *Overexcitation Limiter - Maximum Current (A)*: enter the maximum allowed current level value (0 to 25A, with minimum increase of 0.1A).
- ❖ *Overexcitation Limiter - Time Delay (s)*: enter the minimum operation time value during which the MEC-100 is authorized to supply the *Maximum excitation Current* (0 to 600s, with minimum increase of 1s).
- ❖ *Overexcitation Limiter* - enter the maximum continuative current level value (0 to 15A, with minimum increase of 0.1A).
- ❖ *Overexcitation Limiter - Enable Limiter*: click to activate the over-excitation limiter.
- ❖ *Overexcitation Limiter - Apply to Relay 1*: click to assign the limitation intervention signal to relay 1.
- ❖ *Overexcitation Limiter - Apply to Relay 2*: click to assign the limitation intervention signal to relay 2.
- ❖ *Underexcitation Limiter - Leading Power at PF=0 (%)*: enter the maximum allowed absorbed reactive power value, expressed in percentage with respect to the maximum reactive power (0 to 50%, with minimum increase of 1%).
- ❖ *Underexcitation Limiter - Enable Limiter*: click to activate the under-excitation limiter.
- ❖ *Underexcitation Limiter - Apply to Relay 1*: click to assign the limitation intervention signal to relay 1.
- ❖ *Underexcitation Limiter - Apply to Relay 2*: click to assign the limitation intervention signal to relay 2.

LIMITERS				
PARAMETER	UNIT	MIN	MAX	DATA
<b>Underfrequency Limiter</b>				
Corner Frequency	Hz	40	60	45,0
Zero Volt Frequency	Hz	0	40	10,0
<input type="checkbox"/> Enable Limiter				
<b>Overexcitation Limiter</b>				
Maximum Current	A	0	25	10,0
Time Delay	s	0	600	3
Max. Continuative Current	A	0	15	5,0
<input type="checkbox"/> Enable Limiter <input type="checkbox"/> Apply to Relay1 <input type="checkbox"/> Apply to Relay2				
<b>Underexcitation Limiter (% of Rated Apparent Power)</b>				
Leading Power at PF=0	%	0	60	50
<input type="checkbox"/> Enable Limiter <input type="checkbox"/> Apply to Relay1 <input type="checkbox"/> Apply to Relay2				



**BY DEFAULT, LIMITERS AND PROTECTIONS ARE INITIALLY DISABLED.** Pay particular attention, when configuring the MEC-100, to the activation of all concerned protections.



Field Protections Window



TO DO:

- ❖ *Field Overcurrent - Maximum Current (A)*: enter the maximum allowed field current level value (0 to 15A, with minimum increase of 0.1A).
- ❖ *Field Overcurrent - Time Delay (s)*: enter in this field the protection time delay (0 to 10s, with minimum increase of 0.1s).
- ❖ *Field Overcurrent - Enable Protection*: click to activate the field over-current protection function.
- ❖ *Field Overcurrent - Apply to Relay 1*: click to assign the protection intervention signal to relay 1.
- ❖ *Field Overcurrent - Apply to Relay 2*: click to assign the protection intervention signal to relay 2.
  
- ❖ *Field Overvoltage - Voltage Threshold (V)*: enter the maximum allowed field voltage level value (0 to 200V, with minimum increase of 1V).
- ❖ *Field Overvoltage - Time Delay (s)*: enter in this field the protection time delay (0 to 300s, with minimum increase of 0.1s).
- ❖ *Field Overvoltage - Enable Protection*: click to activate the field over-voltage protection function.
- ❖ *Field Overvoltage - Apply to Relay 1*: click to assign the protection intervention signal to relay 1.
- ❖ *Field Overvoltage - Apply to Relay 2*: click to assign the protection intervention signal to relay 2.

FIELD PROTECTIONS				
PARAMETER	UNIT	MIN	MAX	DATA
<b>Field Overcurrent</b>				
Maximum Current	A	0	15	10,0
Time Delay	s	0	10	5
<input type="checkbox"/> Enable Protection <input type="checkbox"/> Apply to Relay1 <input type="checkbox"/> Apply to Relay2				
<b>Field Overvoltage</b>				
Voltage Threshold	V	0	200	190
Time Delay	s	0	300	10
<input type="checkbox"/> Enable Protection <input type="checkbox"/> Apply to Relay1 <input type="checkbox"/> Apply to Relay2				

Generator Protections Window



TO DO:

- ❖ *Generator Overcurrent - Maximum Current (%)*: enter the maximum allowed generator current, expressed in percentage with respect to the generator rated current value (0 to 120%, with minimum increase of 1%).
- ❖ *Generator Overcurrent - Maximum Continuable Current (%)*: enter the maximum continuous generator current, expressed in percentage with respect to the generator rated current value (0 to 110%, with minimum increase of 1%).
- ❖ *Generator Overcurrent - Time Delay (s)*: enter the time delay during which the MEC-100 is authorized to supply the *Maximum Current* (0 to 3600s, with minimum increase of 1s).
- ❖ *Generator Overcurrent - Enable Protection*: click to activate the generator over-current protection function.
- ❖ *Generator Overcurrent - Apply to Relay 1*: click to assign the protection intervention signal to relay 1.
- ❖ *Generator Overcurrent - Apply to Relay 2*: click to assign the protection intervention signal to relay 2.
  
- ❖ *Generator Overvoltage - Voltage Threshold (%)*: enter the maximum generator voltage, expressed in percentage with respect to the generator rated voltage value (100 to 150%, with minimum increase of 1%).
- ❖ *Generator Overvoltage - Time Delay (s)*: enter the time delay (0 to 300s, with minimum increase of 1s).
- ❖ *Generator Overvoltage - Enable Protection*: click to activate the generator over-voltage protection function.
- ❖ *Generator Overvoltage - Apply to Relay 1*: click to assign the protection intervention signal to relay 1.
- ❖ *Generator Overvoltage - Apply to Relay 2*: click to assign the protection intervention signal to relay 2.

GENERATOR PROTECTIONS				
PARAMETER	UNIT	MIN	MAX	DATA
<b>Generator Overcurrent</b>				
Maximum Current	%	0	120	110
Maximum Continuable Current	%	0	110	100
Time Delay	s	0	3600	2
<input checked="" type="checkbox"/> Enable Protection <input checked="" type="checkbox"/> Apply to Relay1 <input type="checkbox"/> Apply to Relay2				
<b>Generator Overvoltage</b>				
Voltage Threshold	%	100	150	112
Time Delay	s	0	300	10
<input checked="" type="checkbox"/> Enable Protection <input checked="" type="checkbox"/> Apply to Relay1 <input type="checkbox"/> Apply to Relay2				
<b>Generator Undervoltage</b>				
Voltage Threshold	%	0	100	75
Time Delay	s	0	300	10
<input checked="" type="checkbox"/> Enable Protection <input checked="" type="checkbox"/> Apply to Relay1 <input type="checkbox"/> Apply to Relay2				
<b>Loss of Sensing</b>				
<input checked="" type="checkbox"/> Enable Protection <input checked="" type="checkbox"/> Apply to Relay1 <input type="checkbox"/> Apply to Relay2				
<input checked="" type="radio"/> Shutdown <input type="radio"/> FCR				







- ❖ *Generator Undervoltage - Voltage Threshold (%)*: enter the minimum generator voltage, expressed in percentage with respect to the generator rated voltage value (0 to 100%, with minimum increase of 1%).
- ❖ *Generator Undervoltage - Time Delay (s)*: enter the time delay (0 to 300s, with minimum increase of 1s).
- ❖ *Generator Undervoltage - Enable Protection*: click to activate the generator undervoltage protection function.
- ❖ *Generator Undervoltage - Apply to Relay 1*: click to assign the protection intervention signal to relay 1.
- ❖ *Generator Undervoltage - Apply to Relay 2*: click to assign the protection intervention signal to relay 2.
  
- ❖ *Loss of Sensing - Enable Protection*: click to activate the loss of sensing protection function.
- ❖ *Loss of Sensing - Apply to Relay 1*: click to assign the protection intervention signal to relay 1.
- ❖ *Loss of Sensing - Apply to Relay 2*: click to assign the protection intervention signal to relay 2.
- ❖ *Loss of Sensing - Shutdown/FCR*: select the desired intervention mode. If *Shutdown* is selected, an instantaneous de-excitation of the generator will be operated when the loss of sensing occurs, if *FCR* is selected, an instantaneous switch to FCR Mode will be operated when the loss of sensing occurs.

Diode Monitoring Window



TO DO:

- ❖ *Low Level - Maximum Ripple (%)*: enter the maximum allowed excitation current ripple (low level of failure), expressed in percentage with respect to the generator rated excitation current value (0 to 100%, with minimum increase of 1%).
- ❖ *Low Level - Delay (s)*: enter the time delay (0 to 100s, with minimum increase of 1s).
  
- ❖ *High Level - Maximum Ripple (%)*: enter the maximum allowed excitation current ripple (high level of failure), expressed in percentage with respect to the generator rated excitation current value (0 to 100%, with minimum increase of 1%).
- ❖ *High Level - Delay (s)*: enter the time delay (0 to 10s, with minimum increase of 1s).
  
- ❖ *Protection Options - Enable Monitoring*: click to activate the diode monitoring function (both *Low Level* and *High Level*).
- ❖ *Protection Options - Enable Shutdown*: click to activate the shutdown option (only for *High Level*).
  
- ❖ *Alarm Options - Low Level - Apply to Relay 1*: click to assign to relay 1.
- ❖ *Alarm Options - Low Level - Apply to Relay 2*: click to assign to relay 2.
- ❖ *Alarm Options - High Level - Apply to Relay 1*: click to assign to relay 1.
- ❖ *Alarm Options - High Level - Apply to Relay 2*: click to assign to relay 2.

DIODE MONITORING DEVICE				
PARAMETER	UNIT	MIN	MAX	DATA
<b>Low Level</b>				
Maximum Ripple	%	0	100	40
Delay	s	0	100	10.0
<b>High Level</b>				
Maximum Ripple	%	0	100	100
Delay	s	0	10	5.0
<b>Protection Options</b>				
<input checked="" type="checkbox"/> Enable Monitoring <input type="checkbox"/> Enable Shutdown				
<b>Alarm Options</b>				
Low Level	<input checked="" type="checkbox"/> Apply to Relay1 <input type="checkbox"/> Apply to Relay2			
High Level	<input type="checkbox"/> Apply to Relay1 <input checked="" type="checkbox"/> Apply to Relay2			

Levels Set-up: Diode Monitoring function is usually set in factory (and left disabled).

If new setting should be necessary, follow this procedure:

- ❖ Generator start, rated speed, no load conditions.
- ❖ Take note of the *Excitation Current Ripple %* measured by MEC-100. If this value is higher than 10%, stop the generator and check the rectifier bridge, cause a damage to one or more diodes is occurred.
- ❖ Apply the rated load to the generator and take note of the new ripple% measured by MEC-100. *Low Level* must be set to this value + 5%. *High Level* must be set to this value x 3 times. Example: ripple%=20% => *Low Level*=20+5=25% and *High Level*=20x3=60%. If calculated *High Level* should be higher than 100%, set this value to 100% anymore.
- ❖ If the instructions above are not executable, set *Low Level*=40% and *High Level*=100% or contact After Market Department (see Section 7).

Power Factor		1.0	-
Other parameters			
Bus Voltage		169	V
Analog Input 1		0.0	mA
Analog Input 2		0.0	mA
Excit. Current Ripple		7	%
Firmware Release	2.01	Card Type	MEC-100



## 6.7. SAVING A SET OF PARAMETERS



TO DO:

- ❖ Click the *Database* button in the menu bar of the MEC-100 Interface System.
- ❖ In the displayed pull-down menu, point to the *Save Parameter File On-line* item and click.
- ❖ In the File Manager window, select a directory where to save the file, type the file name and click on *OK*.

To load a parameter set, see the User Manual.



**PAY ATTENTION TO SAVE ALWAYS THE PARAMETER FILE AFTER PRELIMINARY SET-UP.**

## 7. WARRANTY, AFTER SALES SERVICE AND MAINTENANCE

### 7.1. WARRANTY

The General Contract Conditions are specified in the presentation window at the MEC-100 Interface System start-up (see Par. 5.3.1); see also the packing documentation and the relevant file in installation CD-ROM. Please always refer to this document for all the warranty details.

### 7.2. PREVENTIVE MAINTENANCE

The only preventive maintenance required on the MEC-100 is a periodical check-up of the connections between the MEC-100 and the system: pay attention that all the connections are clean and tight and no damages or faults are affecting the wiring.

The MEC-100 is completely resin-bonded and isolated to keep a high operating reliability even in difficult working conditions (high levels of humidity, dust, salty atmosphere) and in presence of vibrations: if it is not working or not correct behaviours are present, MEC-100 must not be repaired or modified without Marelli Motori S.p.A. approval.

### 7.3. AFTER SALES SERVICE

For any malfunctions, damages or any other queries, please contact Marelli Motori S.p.A. After Sales Department.



**AFTER MARKET DEPARTMENT  
MARELLI MOTORI S.p.A.**

**Tel: +39 0444 479 775**

**Fax: +39 0444 479 757**

**E-mail: [service@marellimotori.com](mailto:service@marellimotori.com)**

**Web: [www.marellimotori.com](http://www.marellimotori.com)**



NOTES:





NOTES:





NOTES:



Tutti i diritti di traduzione, riproduzione e adattamento, totale o parziale, con qualsiasi mezzo ( comprese le copie fotostatiche e i microfilm ) sono riservati.

Neither this book nor any part may be reproduced or transmitted in any form or by any means, electronic or mechanical ,including photocopying, microfilm, and recording, or by any information storage and retrieval system, without permission and writing from the publisher.



Questo manuale è stampato su carta riciclata: un contributo MarelliMotori alla salvaguardia dell'ambiente.

This manual is printed on recycled paper: MarelliMotori contribution to the safeguarding of the environment.

Ce manuel est imprimé sur papier recyclé: une contribution de MarelliMotori pour la sauvegarde de l'environnement.

Dieses Handbuch ist auf wiederverwertbarem Umweltpapier gedruckt: Ein Beitrag von Marelli Motori zum Schutz der Natur.

Este manual ha sido impreso en papel reciclado: una contribución de MarelliMotori para la salvaguardia del medio ambiente.



**Marelli Motori S.p.a.**

Via Sabbionara, 1 - 36071 Arzignano (VI) Italy  
(T) +39 0444.479711 - (F) +39 0444.479888  
[www.marellimotori.com](http://www.marellimotori.com)  
[sales@marellimotori.com](mailto:sales@marellimotori.com)



(T) +39 0444.479775 - (F) +39 0444.479757  
[service@marellimotori.com](mailto:service@marellimotori.com)



**MarelliMotori overseas offices:**

**GREAT BRITAIN**

**Marelli UK Ltd**  
Meadow Lane  
Loughborough  
Leicester  
LE 11 1NB - UK  
(T) +44 1509.615518  
(F) +44 1509.615514  
[uk@marellimotori.com](mailto:uk@marellimotori.com)

**CENTRAL EUROPE**

**Marelli Central Europe GmbH**  
Heilswannenweg 50  
31008 Elze - Germany  
(T) +49 5068.462.400  
(F) +49 5068.462.409  
[germany@marellimotori.com](mailto:germany@marellimotori.com)

**USA**

**Marelli USA, Inc**  
1620 Danville Road  
PO Box 410 Harrodsburg  
KY 40330 - USA  
(T) +1 859.734-2588  
(F) +1 859.734-0629  
[usa@marellimotori.com](mailto:usa@marellimotori.com)

**ASIA PACIFIC**

**Marelli Asia Pacific Sdn Bhd**  
Lot 7, Jalan Majistret U1/26  
Hicom - Glenmarie Industrial Park  
40150 Shah Alam  
Selangor D.E. - Malaysia  
(T) +60 3.7805.3736  
(F) +60 3.7803.9625  
[asiapacific@marellimotori.com](mailto:asiapacific@marellimotori.com)

**SOUTH AFRICA**

**Marelli Electrical Machines South Africa (Pty) Ltd**  
Unit 4, 55 Activia Rd Activia Park  
Elandsfontein, 1406  
Gauteng, Republic of South Africa  
(T) +27 11.822.5566  
(F) +27 11.828.8089  
[southafrica@marellimotori.com](mailto:southafrica@marellimotori.com)