

HART Intelligent Temperature Transmitter TT421 User Manual



Features

- Smart two-wire, 4-20 mA loop power transmitter with HART communication
- Measures temperature using resistive sensors (RTD's), thermocouples, sensors with resistance or mV outputs
- Linearization international standards and custom calibration according to Callendar Van Dusen
- Measurement Type
 - Single sensor; 2, 3, or 4 wire configurations
 - Dual Sensor
 - * Differential
 - * Average
 - * Maximum
 - * Minimum
- Extensive transmitter and sensor diagnostics
- Factory tested isolation for 1500V
- Mounts in industry standard DIN Form B connection head
- Configured to customer specifications prior to shipping

The TT421 is a HART enabled intelligent temperature transmitter made by Smar Research. This device measures temperature using RTD's, thermocouples, resistance or mV input. The TT421 mounts in the industry standard DIN Form B connection head for easy integration with various sensors. The TT421 meets all HART Foundation physical layer requirements and is fully configurable through software.

It is the purpose of this document to explain the setup, installation, operation and maintenance of the TT421 as well as provide all accompanying technical specifications and data. For the most up to date information on this product and other Smar Research products, visit our website www.SmarResearch.com.

Table of Contents

Section	Page
1) Mounting & Electrical	2
2) Operation	6
3) Programming	12
4) Maintenance & Troubleshooting	22
5) Technical Data & Specifications	25

Section 1 - Mounting & Electrical

General

The overall accuracy of temperature and other measurements depends on several variables. Although the transmitter has outstanding performance, proper installation is essential, in order to maximize its performance.

Among the factors which may affect transmitter accuracy, environmental conditions are the most difficult to control. There are, however, ways of reducing the effects of temperature, humidity and vibration. Temperature fluctuation effects can be minimized by locating the transmitter in areas protected from extreme environmental changes.

In hot environments, the transmitter should be installed to avoid, as much as possible, direct exposure to the sun. Installation close to lines and vessels subjected to high temperatures should also be avoided. For temperature measurements, sensors with cooling-neck can be used or the sensor can be mounted separated from the transmitter housing. Use of sun shades or heat shields to protect the transmitter from external heat sources should be considered, if necessary.

Humidity is fatal to electronic circuits. In areas subjected to high relative humidity, the device should be installed within an isolated panel, which will protect it from the elements. The electronic circuit is protected by a humidity proof coating, but frequent exposures to humidity may affect the protection provided.

Measurement error can be decreased by connecting the sensor as close to the transmitter as possible and using proper wires (see Section II, Operation).

Mounting & Electrical

Mounting is fast and easy using the industry standard DIN Form B connection head. This product is compatible with any standard DIN Form B head type connections as well as any 4-20 mA HART communication network.

Electric Wiring

Access the wiring block by unscrewing the DIN Form B head connection cover. The connection descriptions can be seen on the label as well as in the diagram below. Connection 5 and 6 are used for connection to the HART network. These connections are non-polarized and thus do not require special attention regarding polarity when connecting to the HART network. Connections 1 through 4 are used for the sensor terminals. See Figure 1.1 for more connection details. A typical connection of the TT421 being used as a transmitter can be seen below in Fig. 1.2.

NOTE:

All cables used for connection of the TT421 to the sensor and HART network should be shielded to avoid noise.

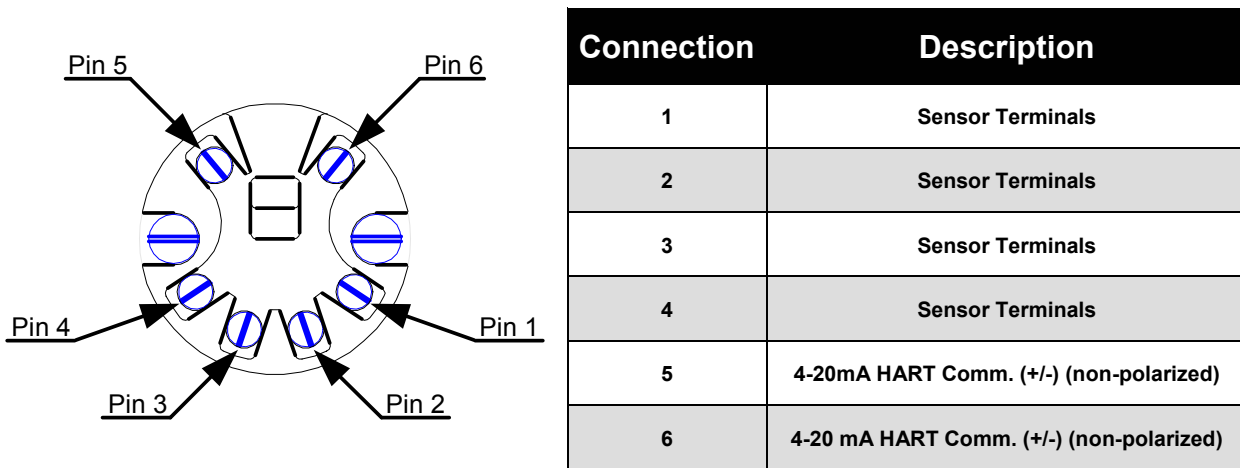

Fig. 1.1 – Connections and description of the TT421.

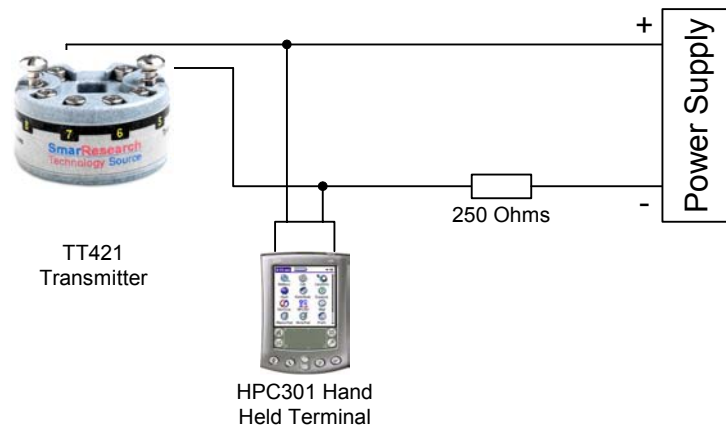

Fig. 1.2 – Wiring Diagram of TT421 working as a transmitter.

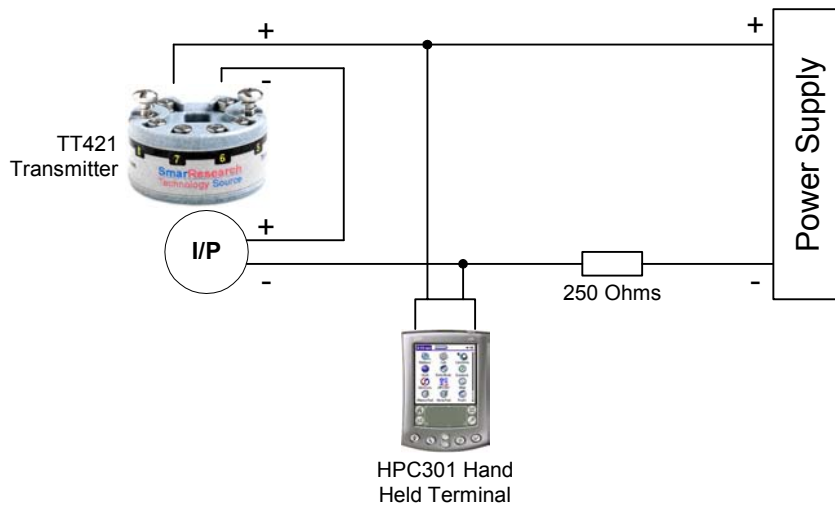

Fig. 1.3 – Wiring Diagram for the TT421 Working as Controller

Connection of the **TT421** working as a controller (Optional) should be as indicated in Figure 1.3.

Connection of the **TT421** in multidrop configuration should be done as in Fig. 1.6. Note that a maximum of 15 transmitters can be connected on the same line and that they should be connected in parallel. When many transmitters are connected to the same line, calculate the voltage drop through the 250 Ohm resistor and verify that the voltage of the power supply is enough (Fig 1.4).

ATTENTION:

For proper operation, the HPC301 Hand-Held Terminal requires a minimum load of 250 Ohm between it and the power supply.

The HPC301 Hand-Held Terminal can be connected to the communication terminals of the transmitter or at any point of the signal line by using a HART interface with alligator clips.

NOTE:

Make sure that the transmitter is operating within the operating area as shown on the load diagram (Fig. 1.6). Communication requires a minimum load of 250 Ohm.

IMPORTANT:

When operating with dual sensors, both cannot be grounded. A minimum of one sensor must NOT be grounded for proper operation of the TT421.

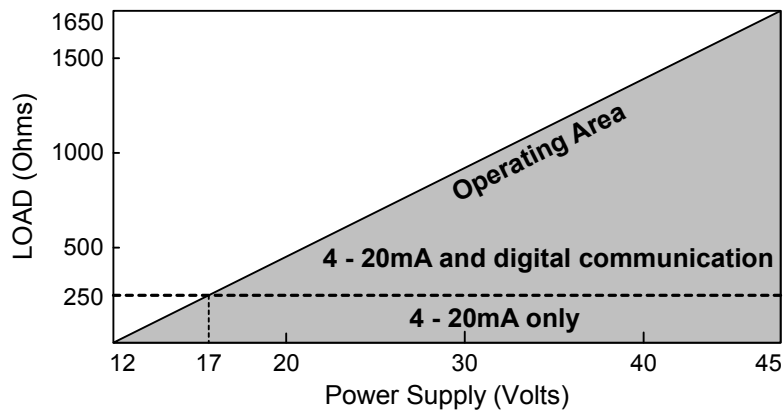

Fig. 1.4 – Load Curve

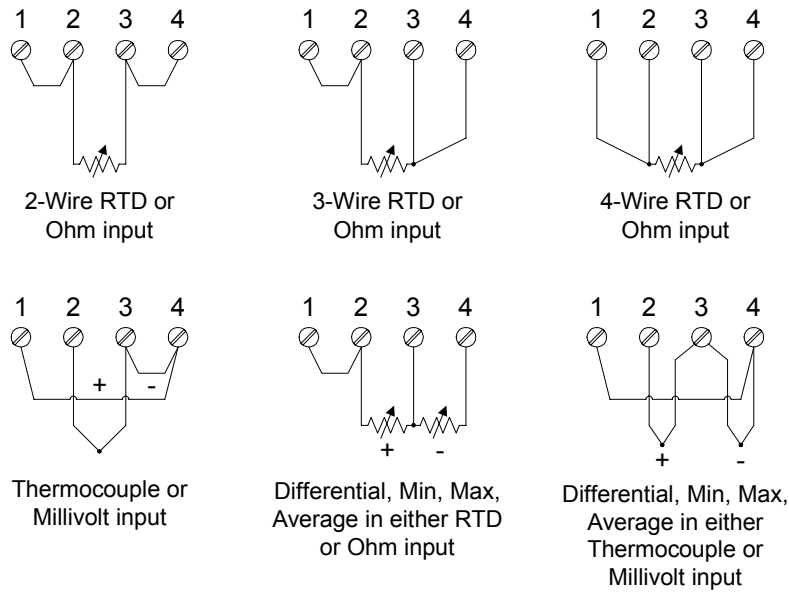

Fig. 1.5 – Sensor Wiring

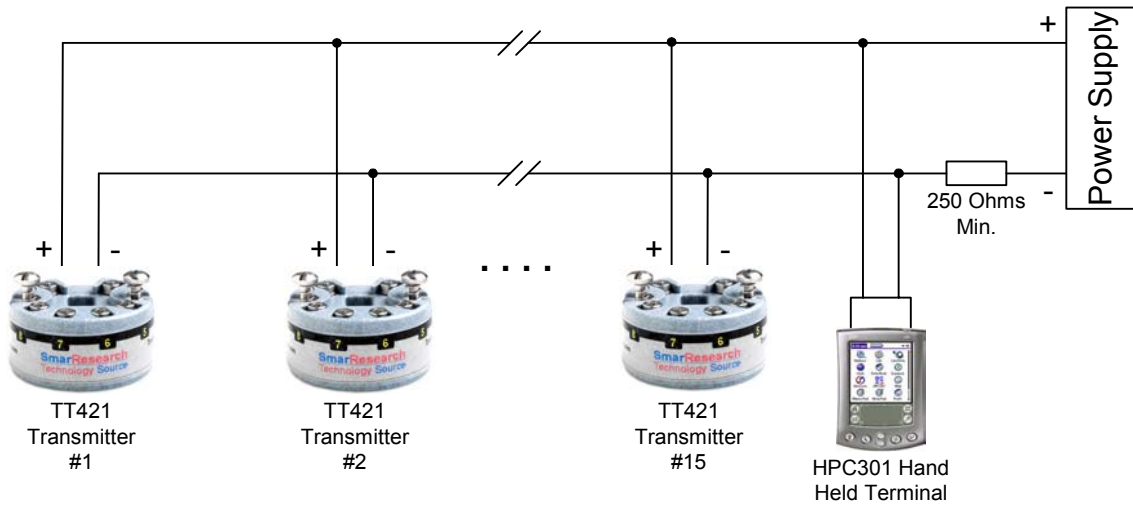

Fig. 1.6 – Wiring Diagram for the TT421 in Multidrop Configuration

Section 2 - Operation

The **TT421** accepts signals from mV generators such as thermocouples, or resistive sensors such as RTD's. The only criteria for compatibility is the signal must be within the input range. For mV, the range is - 50 to 500 mV and for resistance, 0-2000 Ohm.

Functional Description-Hardware

Refer to the block diagram (Fig. 2.1). The function of each block is described below.

MUX-Multiplexer

The MUX multiplexes the sensor terminals to the signal conditioning section ensuring that the voltages are measured between the correct terminals.

Signal Conditioner

Its function is to apply the correct gain to the input signals to make them suit the A/D - converter.

A/D Converter

The A/D converts the input signal to a digital format for the CPU.

Isolator

Its function is to isolate the control and data signal between the input and the CPU.

CPU - Central Processing Unit & PROM

The CPU is the intelligent portion of the transmitter, being responsible for the management and operation of all other blocks: linearization, cold junction compensation and communication. The program is stored in the PROM along with the linearization data for the temperature sensors.

For temporary storage of data, the CPU has an internal RAM, the data in the RAM is lost if the power is switched off, however the CPU also has an internal nonvolatile EEPROM where data that must be retained is stored. Examples of such data are: calibration, configuration and identification data.

D/A Converter

Converts the digital output data from the CPU to an analog signal.

Output

Controls the current in the line feeding the transmitter. It acts as a variable resistive load whose value depends on the voltage from the D/A converter.

Modem

Modulates a communication signal on the current line. A "1" is represented by 1200 Hz and a "0", by 2200 Hz. These signals are symmetric and do not affect the DC level of the 4-20 mA signal.

Power Supply

Uses the power of the loop-line to power the transmitters circuit. This is limited to 3.9 mA.

Power Isolation

Its function is to isolate the power supply between the input and the CPU.

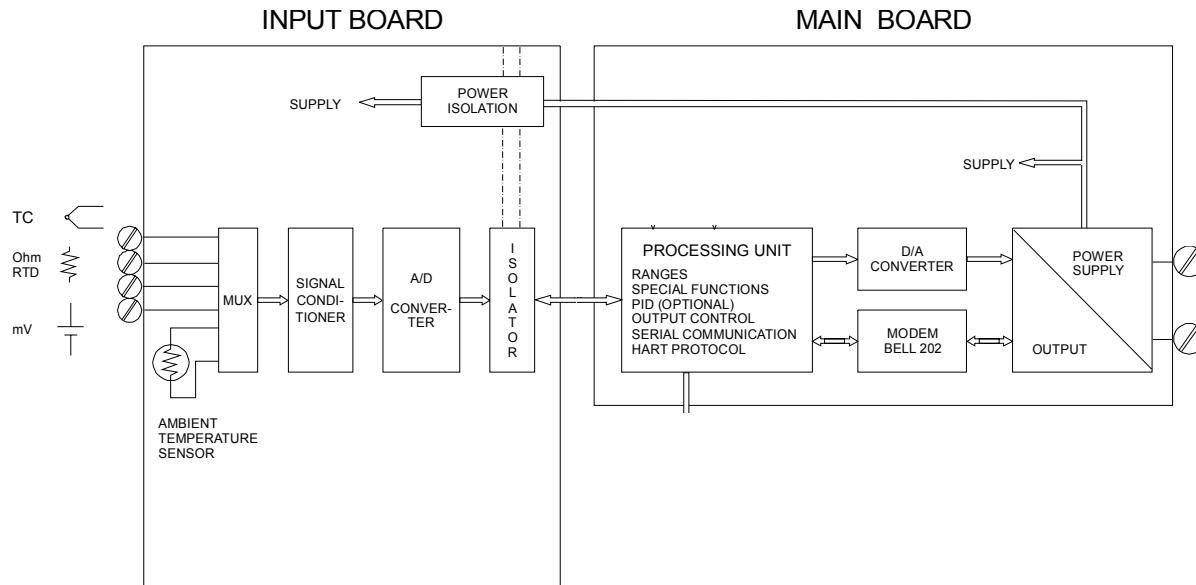

Fig. 2.1 – TT421 Hardware Block Diagram

Functional Description - Software

Refer to the block diagram (Fig. 2.2). The function of each block is described below.

Input

Calculates the actual mV or Ohm value from the value sensed by the input circuitry.

Digital Filter

This is a low-pass filter with an adjustable time constant. It is used to smooth noisy signals. The Damping value is the time required for the output to reach 63.2% for a step input of 100%.

Input Trim

Here, the value obtained by READING-TRIM is used to correct the transmitter for long term drift.

Standard Sensor Linearization & Compensation

Here, the mV and Ohm measurements are linearized and cold-junction compensated according to the sensor characteristics stored in the CPU. The CPU contains data about most available standard sensors.

Special Sensor

Here, the mV and Ohm measurements may be linearized according to a customer specified linearization table stored in TABLE - X,Y. Sensor TYPE and CONNECTION is specified as well. In UNIT, the desired engineering unit is configured. This unit is used in all communications with the transmitter. The LRL, URL and MINimum Span are used to limit the range that can be set so it is within the table and device accuracy limits.

Ranging

This is used to set the process values corresponding to the output of 4 and 20 mA in transmitter mode or process variable 0 and 100% in PID mode. In transmitter mode the LOWER-VALUE is the point corresponding to 4 mA, and UPPER-VALUE is the point corresponding to 20 mA. In PID mode, the LOWER-VALUE corresponds to PV = 0% and UPPER-VALUE corresponds to PV = 100%.

Time Generator (Optional)

Counts the time to be used by the Setpoint generator function. It may be paused by using PAUSE and reset to zero by using RESET.

Setpoint (Optional)

In this block, setpoint tracking may be activated in SP-TRACKING. The setpoint is adjusted in INDIC. The setpoint may also be generated automatically by turning the SP-GENERATOR ON. When running, the setpoint generator will ramp and dwell the setpoint according to a table that can be configured in SP-TABLE.

PID (Optional)

First the error is calculated as SP-PV or PV-SP depending on which action (direct or reverse) is configured in ACTION.

$$MV = Kp(e + \frac{1}{Tr} \int edt + Td \cdot \frac{dPV}{dt})$$

Auto/Manual (Optional)

The Auto/Manual mode is toggled in INDIC. In Manual, MV may be adjusted by the user in the INDIC option. The POWER-ON option is used here to determine in which mode the controller should be on power-up.

Limits (Optional)

This block makes sure that the MV does not go beyond its minimum and maximum limits as established by the HIGH-LIMIT and LOW-LIMIT. It also makes sure that the Rate-of-Change does not exceed the value set in OUT-CHG/S. These values are adjusted in the SAFETY LIMITS option.

Output

Calculates the current proportional to the process variable or Manipulated variable to be transmitted to the 4-20 mA output, depending if the PID Module is ON or OFF. This block also contains the constant current function configured in OUTPUT.

Current Trim

The 4 mA-TRIM and 20 mA-TRIM are used to make the transmitter current comply with a current standard, should a deviation arise.

Temperature Sensors

The **TT421**, as previously explained, accepts several types of sensors. The **TT421** is specially designed for temperature measurement using thermocouples or thermoresistances (RTDs).

Some basic concepts about these sensors are presented below.

Thermocouples

Thermocouples are the most widely used sensors in industrial temperature measurements.

Thermocouples consist of two wires made from different metals or alloys joined at one end, in what is called a measuring junction. The measuring junction should be placed at the point of measurement. The other end of the thermocouple is open and connected to the temperature transmitter. This point is called the reference junction or cold junction. For most applications, the Seebeck effect is sufficient to explain thermocouple behavior.

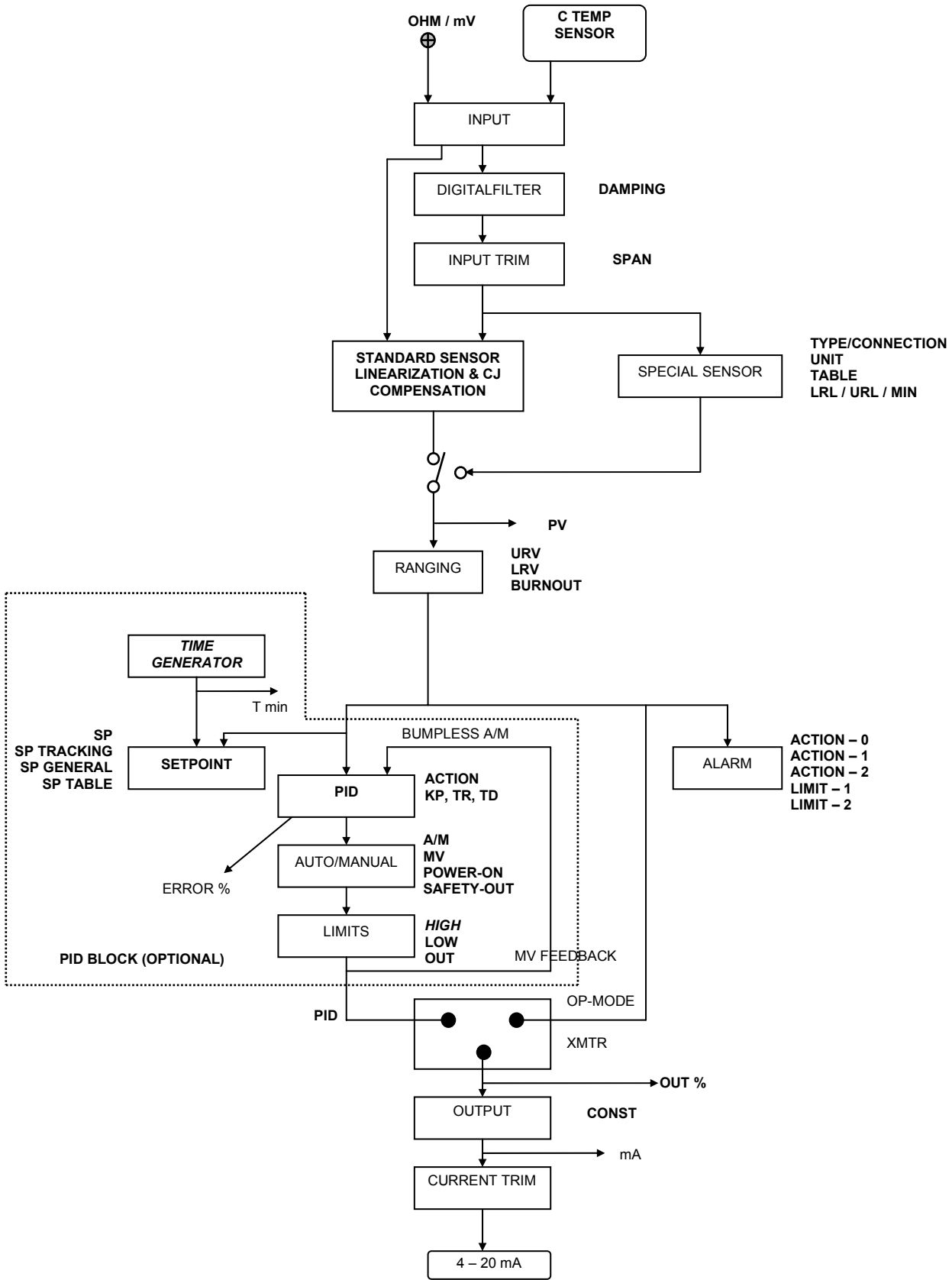

Fig. 2.2 – TT421 Software Function Block Diagram

How the Thermocouple Works

When there is a temperature difference along a metal wire, a small electric potential, unique to every alloy, will occur. This phenomenon is called Seebeck effect.

When two wires of dissimilar metals are joined on one end, and left open on the other, a temperature difference between the two ends will result in a voltage since the potentials generated by the dissimilar materials are different and do not cancel each other out. Two important things must be noted. First: the voltage generated by the thermocouple is proportional to the difference between the measuring-junction and the cold junction temperatures. Therefore the temperature at the reference junction must be added to the temperature derived from the thermocouple output, in order to find the temperature measured. This is called cold junction compensation, and is done automatically by the **TT421**, which has a temperature sensor at the sensor terminals for this purpose. Secondly, if the thermocouple wires are not used all the way to the terminals of the transmitter (e.g. copper wire is used from sensor-head or marshalling box) new junctions with additional Seebeck effects will be created and ruin the measurement in most cases, since the cold-junction compensation will be done at the wrong point.

The relation between the measuring junction temperature and the generated millivoltage is tabulated in thermocouple calibration tables for standardized thermocouple types, the reference temperature being 0°C.

Standardized thermocouple which are commercially used, whose tables are stored in the memory of the **TT421**, are the following:

- ✓NBS (B, E, J, K, N, R, S, T)
- ✓DIN (L, U)

Thermo Resistances (RTDs)

Resistance Temperature Detectors, most commonly known as RTD's, are based on the principle that the resistance of a metal increases as its temperature increases.

Standardized RTDs, whose tables are stored in the memory of the **TT421**, are the following:

- ✓JIS [1604-81] (Pt50 & Pt100)
- ✓IEC, DIN, JIS [1604-89] (Pt50, Pt100 & Pt500)
- ✓GE (Cu 10)
- ✓DIN (Ni 120)

For a correct measurement of RTD temperature, it is necessary to eliminate the effect of the resistance of the wires connecting the sensor to the measuring circuit. In some industrial applications, these wires may be hundreds of meters long. This is particularly important at locations where the ambient temperature changes a lot.

The **TT421** permits a 2-wire connection which may cause measuring errors, depending on the length of connection wires and on the temperature to which they are exposed (see Fig. 2.3).

In a 2-wire connection, the voltage V_2 is proportional to the RTD resistance plus the resistance of the wires.

$$V_2 = [RTD + 2x R] \times I$$

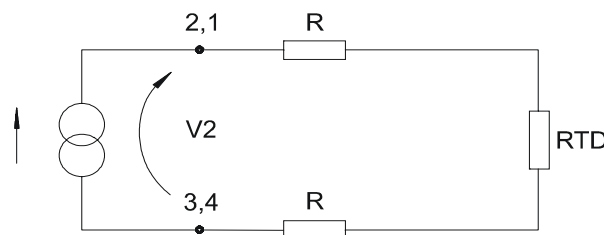

Fig. 2.3 – Two-Wire Connection

In order to avoid the resistance effect of the connection wires, it is recommended to use a 3-wire connection (see Fig. 2.4) or a 4-wire connection (see Fig. 2.5).

In a 3-wire connection, terminal 3 is a high impedance input. Thus, no current flows through that wire and no voltage drop is caused. The voltage $V_2 - V_1$ is independent of the wire resistances since they will be canceled out, and is directly proportional to the RTD resistance alone.

$$V_2 - V_1 = [RTD + R] \times I - R \times I = RTD \times I$$

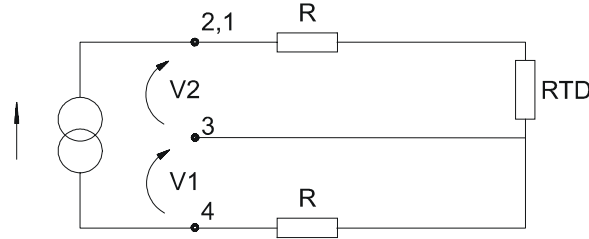

Fig. 2.4 – Three-Wire Connection

In a 4-wire connection, terminals 2 and 3 are high impedance inputs. Thus, no current flows through those wires and no voltage drop is caused. The resistance of the other two wires are not interesting since no measurement is done on them. Hence the voltage V_2 is directly proportional to the RTD resistance. ($V_2 = RTD \times I$).

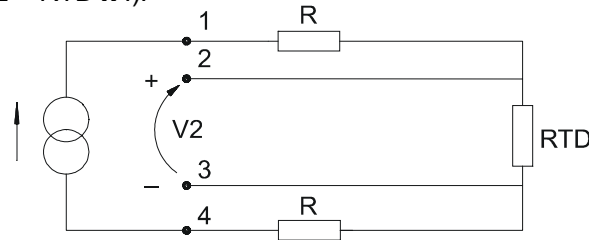

Fig. 2.5 – Four-Wire Connection

A differential connection is similar to the two-wire connection and gives the same problem (see Fig. 2.6). Terminal 3 is a high impedance input. Thus, no current flows through and no voltage drop is caused. However, the resistance of the other two wires will be measured and do not cancel each other out in the temperature measurement, since linearization will affect them differently.



Fig. 2.6 – Differential Connection

Alarm

The alarms are software alarms and have no external contacts available on the transmitter. The alarms are acknowledged by using the HPC301 Hand-Held Terminal, which can also view and configure them individually.

Section 3 - Programming

This section of the TT421 User Manual will briefly explain the HPC301 user interface and its various commands. For more in-depth information on the HPC301 software please refer to the *HPC301 User Manual*.

The Hand-Held Terminal

The Smar HPC301 Hand-Held Terminal is the human machine interface used to maximize the advances of digital technology.

The TT421 firmware allows the following configuration features to be accessed by the Palm software, HPC301:

- Transmitter identification and specification data.
- Remote re-ranging.
- Special sensor parameter adjustments.
- Constant current adjustment between 3.6 and 21 mA for loop test.
- Monitoring of process variable in Engineering Units, % and mA.
- Controller monitoring for Setpoint, Process Variable, Manipulated Variable and Auto/Manual status.
- Controller parameters adjustment.
- Setpoint generator parameters adjustment.
- Diagnosis and determining of faults in the processor or in the transmitter.



Figure 3.1 - Smar's HPC301 Hand-Held Terminal

The operations which take place between the HPC301 Hand Held Terminal and the transmitter do not interrupt the measurement, and do not disturb the output signal. The HPC301 Hand Held Terminal can be connected on the 4-20 mA line up to 2 km away from the transmitter.

Terminal Programming Tree

The Programming tree is a tree-shaped structure with a menu of all the available software resources, as shown in Figure 3.2.

WARNING:

All transmitters are factory configured with no passwords. To avoid operation by nonauthorized persons in some critical levels of the Programming Tree, it is recommended to configure all passwords and configuration levels prior to operation. See "PASSWORD" option in Maintenance section.

On Line Single Unit Configuration

To configure the transmitter on line, certify that it is correctly installed, with a suitable power supply and the minimum 250 Ω load required.

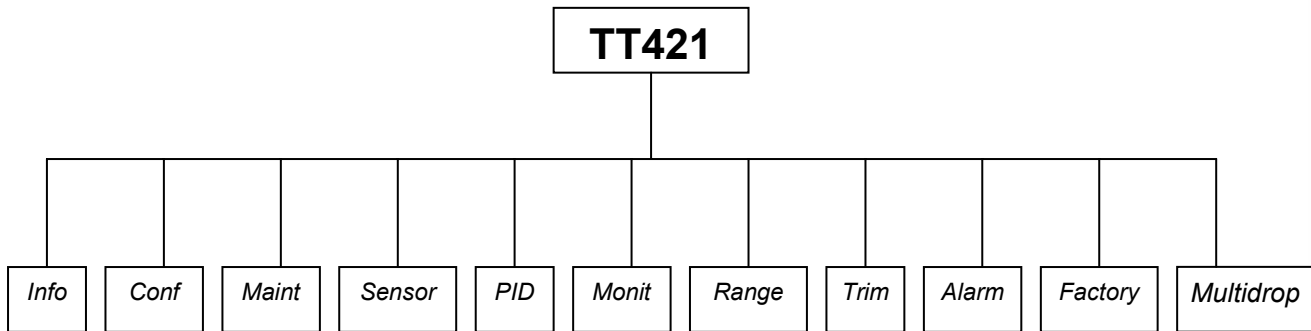

Fig. 3.2 - Terminal Programming Tree

INFO - The main information about the transmitter can be accessed here. These include Tag, Descriptor, Message, Date and Unique ID.

CONF - The burnout can be changed between High or Low here.

MAINT - Loop tests, device resets, operation counters, password level setting and ordering codes can all be accessed here.

SENSOR - Here the TT421 input can be configured to the sensor type and connection type that is being used.

PID - All control parameters may be adjusted and monitored here.

MONIT - Allows the user to monitor 4 of the transmitters dynamic variables and output current.

RANGE - The output related parameters can be configured here: Lower Value, Upper Value, Unit, Damping.

TRIM - The transmitter indication can be calibrated to an Ohm/mV and/or a current standard here.

ALARM - Set any of the 3 alarms here. These can be used as an alert method that is activated with certain actions and trip levels.

FACTORY - Contains preset parameters set by the factory. These are not adjustable by the user, only by the factory.

MULTIDROP - This is where the Polling Address can be set. This assigns a value for the device (0-15) within the HART network when there are several transmitters.

INFO - INFORMATION

The main information about the transmitter can be accessed here. These include Tag, Descriptor, Message, Date and Unique ID. There is also a device info screen that contains additional important device information. This includes Manufacturer, Device Type, Device Serial Number and software and hardware revision numbers among others.

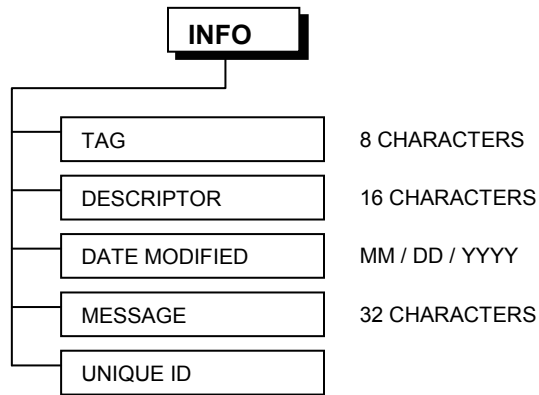

Fig. 3.3 – Terminal Information Tree

TAG: Eight character alphanumeric field for identification of the transmitter.

DESCRIPTOR: 16-character alphanumeric field for additional identification of the transmitter. May be used to identify service or location.

DATE MODIFIED: The date may be used to identify a relevant date as the last calibration, the next calibration or the installation. The date is presented in the form of Month, Day, Year.

MESSAGE: 32-character alphanumeric field for any other information, such as the name of the person who made the last calibration, some special care to be taken, etc.

UNIQUE ID: Readable only information.

CONF - CONFIGURATION

The burnout can be changed between High or Low here.

Burnout

Burnout can occur when the sensor reading is out of range or open. In these cases, the transmitter can be set to output the maximum limit of 21 mA by setting the burnout to High, or the minimum limit of 3.6 mA by setting the burnout to Low. If the TT421 operates as a controller, the safety-out in PID should be used instead.

MAINT - MAINTENANCE

Loop tests, device resets, operation counters, password level setting and ordering codes can all be accessed here.

Here is a description of features which can be performed in the MAINTENANCE function:

- **Device Reset:** Power ON/OFF
- **Loop Test:** The output can be set to any desired value between 3.6 and 21 mA regardless of input.
- **Operations Counter:** This feature allows you to view the number of changes done to the Zero Span, Fixed Current, Trim (4 & 20mA), Burnout, Sensor, Auto/Manual, and Multidrop
- **Passwords:** Set passwords and access levels
- **Ordering Code:** Contains the factory ordering code of the device.

SENSOR

Here the TT421 input can be configured to the sensor type and connection type that is being used. The TT421 supports RTD's, thermocouples, resistance or mV inputs. Below is a list of the sensor types supported. The TT421 also supports 5 different measurement types for RTD, Ohm, TC or mV sensor types: single, differential, average, maximum and minimum. These measurement types are defined below.

RTD: Resistive Temperature Detectors

Types: Cu10 (GE)
 Ni120 (DIN)
 Pt50, 100, 500 (IEC)
 Pt50, 100 (JIS)
 Configurable for 2, 3, 4 wires or differential

Ohm: Linear Resistance Measurement

Types: 0 - 100 Ohm
 0 - 400 Ohm
 0 - 2000 Ohm
 Configurable for 2, 3, 4 wires or differential

TC: Thermocouples

Types: B, E, J, K, N, R, S, T (NBS)
 L, U (DIN)
 Configurable for 2 wires or differential

mV: Linear Voltage Measurement

Types: -6 - 22 mV
 -10 - 100 mV
 -20 - 500 mV
 Configurable for 2 wires or differential

Special: Special Sensor is used for special sensors, e.g., load cells or resistive position indicators. It turns the TT421 into a transmitter for mass, volume, position, etc.
 Types - Ohm - Resistive output
 mV - Voltage output
 Configurable for 2, 3, 4 wires or differential

Van Dusen:

Types: RTD's
 Parameters: RO, A, B, C

COLD JUNCTION - This function is used to enable or disable the cold junction compensation for TC, mV or special sensors. This feature automatically compensates for temperature differences between the sensor location and the junction box location.

MEASUREMENT TYPE - This parameter is used to set the measurement type for the selected sensor. This effects the resulting primary variable value. Only when using a sensor of type RTD, Ohm, TC, or mV, will a Measurement Type be selectable from the menu. There are total of 5 measurement types, Single, Differential, Average, Maximum and Minimum. Single is to be used when using a single sensor. For dual sensor applications, all other measurement types may be used. For dual sensor applications the sensors should be connected as described in Figure 1.5. Each Measurement Type is described below.

Single - Used for all single sensor configurations. Straightforward value from single sensor.

Differential - Subtracts the (+) sensor value from the (-) sensor value. See Fig. 1.5.

Average - Calculates the average of the two sensor readings.

Maximum - Sets the PV to the higher of the two sensor readings.

Minimum - Sets the PV to the lower of the two sensor readings.

Special Sensor Configuration

Special Sensor is a function that allows sensors whose characteristics are not stored in the TT421 memory as a standard to be used. Any sensor may be used, provided that the TT421 can accept the sensors output. The mV and Ohm limitations can be seen in table 3.2.

The sensors characteristic can be programmed into the TT421's EEPROM in form of a 16-point table. Such tables are usually made available by the sensor manufacturer but can also be obtained by testing it. The special sensor function can not be used at the same time as the Setpoint generator. To change the special sensor configuration, select special in the sensor menu.

Special:

Types - Ohm - Resistive output
 mV - Voltage output
 Configurable for 2, 3, 4 wires or differential

LRL - Lower Range Limit
 The minimum lower value that the software will be configured to read.

URL - Upper Range Limit
 The maximum upper value that the software will be configured to read.

Min - Minimum Span
 The minimum Span that should be configurable, in reading value, not sensed input.

Unit - Engineering Unit that should be associated with the measured variable. If one of over 100 standard units is selected, it will automatically get its HART protocol code. This way all supervisory systems supporting HART can access the unit. Should a special unit be necessary, select SPECIAL in the UNIT menu.

Table (x, y) - Linearization Table
 Table that relates the measured input to reading
X = sensed input in Ohm or mV
Y = desired reading

VARIABLES	UNITS
PRESSURE	inH ₂ O, InHg, ftH ₂ O, mmH ₂ O, mmHg, psi, bar, mbar, g/cm ² , Pa, KPa, Ton, ATM
VOLUMETRIC FLOW	ft ³ /m, gal/m, l/min, Gal/m, m ³ /h, gal/s, l/s, Ml/d, ft ³ /s, ft ³ /d, m ³ /d, Gal/h, Gal/d, ft ³ /h, m ³ /m, bbl/s, bbl/m, bbl/h, bbl/d, gal/h, Gal/s, l/h, gal/d
SPEED	ft/s, m/s, m/h
TEMPERATURE	°C, °F, °R, K
VOLTAGE	mv, v
VOLUME	gal, l, Gal, m ³ , bbl, bush, Yd ³ , ft ³ , ln ³
LEVEL	ft, m, in, cm, mm
TIME	min, sec, h, dia
MASS	gram, kg, Ton, lb, Shton, LTon
MASS FLOW	g/s, g/min, g/h, kg/s, kg/m, kg/h, kg/d, Ton/m, Ton/h, Ton/d, lb/s, lb/m, lb/h, lb/d, Ton/d
DENSITY	SGU, g/cm ³ , kg/m ³ , g/ml, kg/l, g/l, TWARD, BRIX, Baum H, Baum L, API, % So/w, % Solv, Ball
MISC.	Ohm, Hz, mA, %, pH, μs, cPo
SPECIAL	5 characters

TABLE 3.1 - Available Special Sensor Unit

Special Sensor Table

This is where the desired reading as a function of the sensor output is tabulated. The sensor output is entered as the x-value. The desired reading is entered as y-value with the limitations: -19999 <= Y <= +19999. Note the following limitations for the x-values:

CONN. TYPE	2, 3 or 4 WIRE	DIFFERENTIAL (each input)
Ohm	0 to 2000	0 to 1000
mV	-20 to 500	-10 to 250

Table 3.2 - Special Sensor Input Range

PID

This function allows the adjustment of the PID parameters including the Setpoint, toggling of the Auto/Manual mode and the tuning parameters.

Here is a list of configurations which can be performed in the PID function:

- **PID Controller:** ON/OFF
- **Tuning Parameters:** This feature allows you to enter values into the **Kp**, **Tr** and/or **Td** fields.
- **PV and SP readouts:** E.U. check box switches readout between engineering unit and percentage.
- **Setpoint Tracking:** Enables or disables setpoint tracking.
- **Control Action:** Select between Direct or Reverse.
- **Control Mode:** Select between Automatic or Manual.
- **Configure MV:** Set the Manipulated Variable.
- **Configure SP:** Set the Setpoint.

SAFETY LIMITS - Control Limits

This option allows the toggling of the SP Power On mode between Automatic, Manual and Last Mode. This option also enables the adjustment of the following parameters of the controller:

Safety out -	Is the output after a power interruption or during a failure.
Out Chg/s -	Is the maximum allowable rate-of-change of the output.
Low Limit -	Is the minimum allowable output (in %).
High Limit -	Is the maximum allowable output (in %).

SP-TABLE - Setpoint table

When the Setpoint generator is on, it will change the Setpoint automatically according to a table (recipe). To configure this table select SP-TABLE in the menu.

MONIT - MONITORING

This function allows simultaneous monitoring of 4 of the transmitters dynamic variables and output current on the display of the **HPC301 Hand Held Terminal**. To activate it, select MONIT in the main menu.

The display will show:

OUT	-	Shows output in mA.
MV	-	Shows output in %.
PV	-	Shows Process Variable in the selected engineering unit.
TAmb	-	Shows ambient temperature in deg C.
PV%	-	Shows Process Variable in %.
SP%	-	Shows Setpoint in %.
SP -	-	Shows Setpoint in the selected engineering unit.
TIME	-	Shows the Setpoint generator time in min.
ER%	-	Shows deviation between SP% and PV%.

RANGE

This function determines the 4-20 mA output of the transmitter. Here the transmitter can be re-ranged or have the damping adjusted. The Engineering Units displayed on the **HPC301 Hand Held Terminal** can also be changed.

Re-Ranging The TT421

To re-range a transmitter is to change the input values related to 4 mA and to 20 mA. There are two ways to do it with the **TT421**:

- 1 - Using the **HPC301 Hand Held Terminal** (from keyboard) where signal input is not required.
- 2 - Using the **HPC301 Hand Held Terminal** with an input signal or calibrator as reference (to applied input).

In transmitter mode, the Lower Value always corresponds to 4 mA and the Upper Value to 20 mA. in PID mode, the Lower Value corresponds to PV=0% and the Upper Value to PV=100%.

Re-Ranging From Keyboard

The **TT421** may be adjusted to give 4 and 20 mA corresponding to given temperature values.

The **TT421** has the expected input, from several standard sensors output at different temperatures, programmed in its memory. Therefore, the zero and span input does not have to be generated when the **TT421** is re-ranged, thus there is no need to connect it to a calibrator for re-ranging purposes.

Observe that both LOWER and UPPER VALUES are completely independent. Adjustment of one does not affect the other. Although, the following rules must be observed:

- a) Both LOWER and UPPER VALUES should not be smaller than lower range or greater than high range.
- b) The span, [(UPPER VALUE)-(LOWER VALUE)], should be greater than the MINIMUM SPAN.

If you intend to reverse a signal, i.e., to have the UPPER VALUE smaller than the LOWER VALUE, proceed as follows:

Make the Lower Value as close to the Upper Value as possible or vice-versa, observing the minimum span allowed , set the Upper Value to the desired setting and then, set the Lower Value.

Example: If the transmitter is ranged, so that:

LOWER VALUE 4 mA = 0 Ohms
UPPER VALUE 20 mA = 100 Ohms

and you want to change the settings to:

LOWER VALUE 4 mA = 100 Ohms
UPPER VALUE 20 mA = 0 Ohms

considering that the Minimum Span IEC Pt100 is 10 Ohms, you must change the settings as follows:

- a) Set the LOWER VALUE = 90, i.e. (100-10)
- b) Set the UPPER VALUE = 0 Ohms
- c) Set the LOWER VALUE = 100 Ohms

Re-ranging to Applied Input

This is the most conventional way to re-range or to calibrate a transmitter. Apply the input to which you want to set the 4 mA/PV=0% point. If, through the HPC301 Hand Held Terminal, you tell the transmitter that this is the 4 mA/PV=0% point, this input is set as the Lower Value and the span is maintained. The same procedure is applied for the Upper Value.

Example: A transmitter with resistance input is ranged, so that:

LOWER VALUE 0 Ohm
UPPER VALUE 100 Ohm

After installation, the potentiometer residual may give a reading of, for instance, 5 Ohm when the resistive position indicator is at zero. The zero suppression is easily accomplished with the re-ranging with reference.

The Lower Value is the transmitter reading of the applied input.

The Upper Range Value may be changed in the same way. As mentioned before, the transmitter reading in Engineering Units of the 4-20 mA points may differ slightly from your plant standard.

Although the 4-20 mA setpoints will operate properly within these applied settings, the transmitter reading, in Engineering Units, may indicate a slightly different value.

The function TRIM-READING can be used to match the transmitter reading in Engineering Units to your plant standard, thereby eliminating any eventual differences.

Unit

The Engineering Units of the **PALM** display may be changed when the option "PV UNIT", of the RANGE function, is selected.

The following units are available;

For mV input: always mV
For Ohm input: always ohm

For thermocouple and RTD input:

- ✓ degrees Celsius
- ✓ degrees Fahrenheit
- ✓ degrees Rankine
- ✓ Kelvins

Damping

This RANGE function enables the electronic damping adjustment. The damping may be adjusted between 0 and 32 sec.

TRIM

The TRIM function is used to make the reading comply with the user's resistance, voltage or current standards.

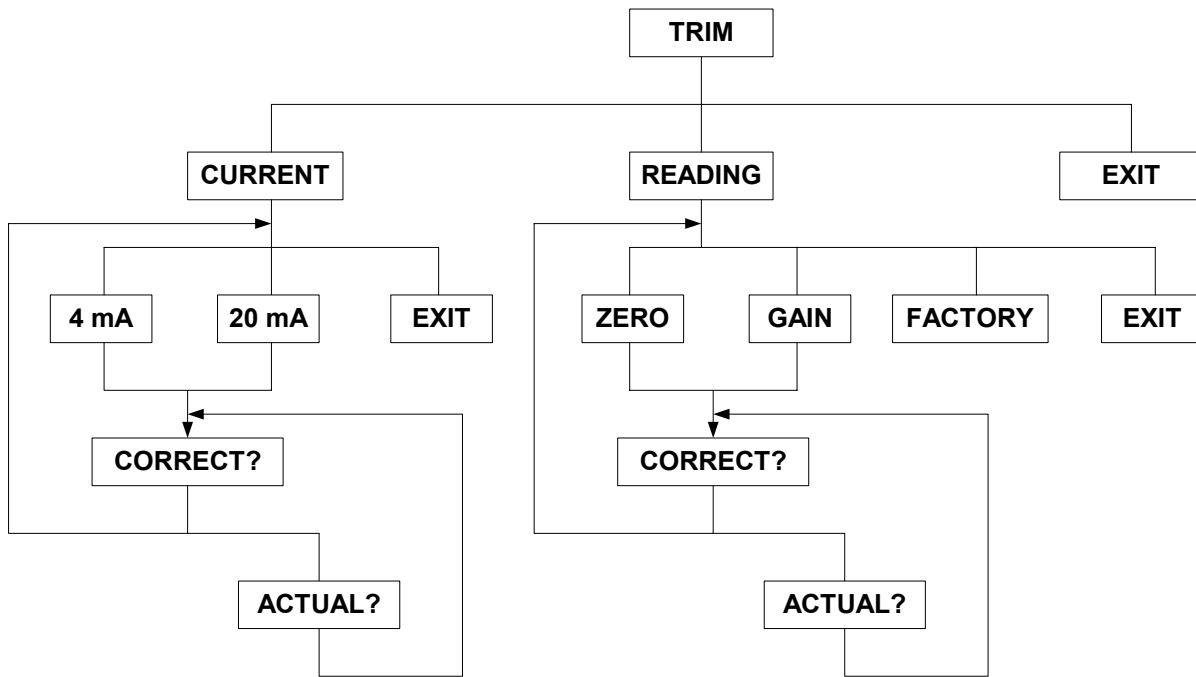

Fig. 3.6 – Terminal Trim Tree

ALARM

The alarm function enables/disables and configures the alarms. The actions and trip levels can be configured independently for alarm 1 and 2. Alarm 0 is a non configurable alarm that indicates burnout. When an enabled alarm condition is met, an on screen alert will notify the user. In addition, alarm status may be monitored and acknowledged from alarm menu.

Acknowledge - Acknowledges an alarm, this will turn off alarm on the transmitter.

Alarm - Configures the operation mode of the alarm: off, low or high.

Limits - Configures the level at which the alarm will trip in %.

Configuring Alarms

Low - The alarm is activated when PV is below the trip level - decreasing signal.

High - The alarm is activated when PV is above the trip level - increasing signal.

Off - The alarm is disabled.

ON-LINE MULTIDROP OPERATION

A multidrop connection is formed by several transmitters connected to a single communication transmission line. Communication between the host and the transmitters takes place digitally with the transmitters analog output deactivated (XMTR mode), or with the analog output activated (PID mode).

The communication with the transmitters and the host (**PALM**, DCS, Data Acquisition System or PC) can be done with a Bell 202 Modem using Hart Protocol. Each transmitter is identified by a unique address from 1 to 15.

The TT421 is factory set to address 0, that means a non multidrop operation mode, allowing transmitter to communicate with the Hand-Held Terminal, superimposing the communication on the 4-20 mA signal. To operate in multidrop mode, the transmitter address must be changed to a number from 1 to 15. This change deactivates the 4-20 mA analog output sending it to 4 mA (XMTR mode), or keeps the 4-20 mA operation when the transmitter is configured for PID operating mode.

$$Ca \geq \sum_{j=1}^n Cj_j + Cc$$

$$I_{sc} \leq \min[I_{max_j}]$$

$$La \geq \sum_{j=1}^n Li_j + Lc$$

$$V_{oc} \leq \min[V_{max_j}]$$

When intrinsic safety is a requirement, special attention must be paid to the entity parameters allowed to that area:

Where:

- Ca, La* - Allowable Capacitance and Inductance
- Cj, Lj* - Non protected internal Capacitance/Inductance of transmitter *j* (*j = up to 15*)
- Cc, Lc* - Cable capacitance and Inductance
- V_{oc}* - Barrier open circuit voltage
- I_{sc}* - Barrier short circuit current
- V_{max_j}* - Maximum allowable voltage to be applied to the instrument *j*
- I_{max_j}* - Maximum allowable current to be applied to the instrument *j*

To operate in multidrop mode, it is necessary to see which transmitters are connected on the same line. This operation is called polling, and it is done automatically as soon as ON-LINE-MULTIDROP option is executed.

Section 4 - Maintenance & Troubleshooting

General

SMAR TT421 intelligent temperature transmitters are extensively tested and inspected before delivery to the end user. Nevertheless, during their design and development, consideration was given to the possibility of repairs by the end user, if necessary.

In general, it is recommended that the end user do not try to repair printed circuit boards. Instead he should have spare circuit boards, which may be ordered from **SMAR** whenever necessary.

Diagnosis with Smar Hand-Held Terminal

Should any problem be noticed related to the transmitter's output, investigation may be carried out by the **PALM**, as long as power is supplied and communication and the processing unit are operating normally.

The programmer should be connected to the transmitter in accordance with the wiring diagram shown on Section 1, Figures 1.4, 1.5 and 1.8.

Error Messages

When communicating using the **PALM** the user will be informed about any problem found by the transmitters self diagnostics.

The messages are always alternated with the information on the top line. The table below lists the error messages. Refer to trouble shooting for more details on corrective action.

Diagnostics with the PALM

DIAGNOSTIC MESSAGES	POTENTIAL SOURCE OF PROBLEM
PARITY ERROR	<ul style="list-style-type: none"> Excessive noise or ripple
OVERRUN ERROR	<ul style="list-style-type: none"> Excessive noise or ripple
CHECK SUM ERROR	<ul style="list-style-type: none"> Excessive noise or ripple
FRAMING ERROR	<ul style="list-style-type: none"> Excessive noise or ripple
NO RESPONSE	<ul style="list-style-type: none"> The line resistance is not in accordance with load curve. Transmitter not powered Interface not connected. Transmitter configured in Multidrop mode being accessed by ON LINE SINGLE UNIT.
LINE BUSY	<ul style="list-style-type: none"> Other device using the line.
CMD NOT IMPLEMENTED	<ul style="list-style-type: none"> Software version not compatible between PALM and transmitter. PALM is trying to carry out a TT421 specific command in a transmitter from another manufacturer.
TRANSMITTER BUSY	<ul style="list-style-type: none"> Transmitter carrying out an important task.
COLD START	<ul style="list-style-type: none"> Start-up or Reset due to power supply failure.
OUTPUT FIXED	<ul style="list-style-type: none"> Output in Constant Mode Transmitter in Multi-drop mode
OUTPUT SATURATED	<ul style="list-style-type: none"> Primary variable out of calibrated Span (Output current in 3.8 or 20.5 mA, XMTR mode only)
SV OUT OF LIMITS	<ul style="list-style-type: none"> Cold-junction temperature sensor out of operating limits. Cold-junction temperature sensor damaged.
PV OUT OF LIMITS	<ul style="list-style-type: none"> Input signal out of operating limits. Sensor damaged. Transmitter with false configuration PV out of range limits (see table)

Troubleshooting the Transmitter

Symptom : NO LOOP CURRENT

Probable Source of Trouble:

- Transmitter Connections
 - Check wiring polarity and continuity.
 - Check for shorts or ground loops.
- Power Supply
 - Check power supply output. The voltage at the **TT421** terminals must be between 12 and 45 Vdc, and the ripple less than 0.4V.
- Electronic Circuit Failure
 - Check the main board for defect by replacing it with a spare one.

Symptom : NO COMMUNICATION

Probable Source of Trouble:

- Terminal Connections
 - Check terminal interface connections.
 - Check if the interface is connected to the points [COMM] and [-] or in the line between the transmitter and the load resistor.
- Transmitter Connections
 - Check if connections are as per wiring diagram.
 - Check line resistance; it must be equal to or greater than 250 Ohm, between the transmitter and the power supply.
- Power Supply
 - Check output of power supply. The voltage at the **TT421** terminals must be between 12 and 45V, and ripple less than 0.4V.
- Electronic Circuit Failure
 - Locate the failure by alternately replacing the transmitter circuit and the interface with spare parts.
- Transmitter Address
 - In On Line Multidrop item, check if the address is "0"

Symptom : CURRENT OF 21.0 mA OR 3.6 mA

Probable Source of Trouble:

- Transmitter Connection
 - Check if the sensor is correctly connected to the **TT421** terminal block.
 - Check if the sensor signal is reaching the **TT421** terminal block by measuring it with a multimeter at the transmitter-end. For mV and thermocouples test can be done with connected and disconnected to the transmitter.
- Sensor
 - Check the sensor operation; it shall be within its characteristics.
 - Check sensor type; it should be the type and standard the **TT421** has been configured to.
 - Check if process is within the range of the sensor and the **TT421**.

NOTE:

A 21.0 or 3.6mA current in XMTR mode indicates burnout.

Symptom : INCORRECT OUTPUT**Probable Source of Trouble:**

- Transmitter Connections
 - Check power supply voltage. The voltage at the **TT421** terminals must be between 12 and 45V, and ripple less than 0.4V.
 - Check for intermittent short circuits, open circuits and grounding problems.
- Noise, Oscillation
 - Adjust damping
 - Check grounding of the transmitters housing, especially for mV and thermocouple input.
 - Check the terminal block for moisture.
 - Check that the shielding of the wires between sensor/transmitter and transmitter/panel is grounded only in one end.
- Sensor
 - Check the sensor operation; it shall be within its characteristics.
 - Check sensor type; it shall be the type and standard that the **TT421** has been configured to.
- Electronic Circuit Failure
 - Check the integrity of circuit replacing it with a spare one.
- Calibration
 - Check calibration of transmitter.

Section 5 - Technical Data & Specifications

Functional Specifications

Inputs

Options see table.

Output Signal

Two-wire, 4-20 mA with superimposed digital communication (HART Protocol Version 5.1/Transmitter/Poll-Response mode/Common 4-20 mA).

Power Supply

12 to 45 Vdc

Load Limitation

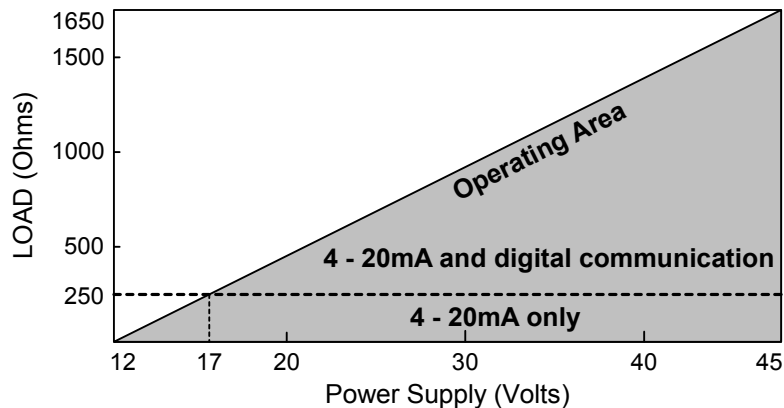

Zero and Span Adjustment

Noninteractive, by HPC301 Hand Held Terminal.

Temperature Limits

Operation: -40 to 75°C (-40 to 167°F)
Storage: -40 to 120°C (-40 to 250°F)

Loss of Input (Burnout)/Failure Alarm

In case of sensor burnout or circuit failure, the self diagnostics drives the output to 3.6 or to 21.0 mA, according to the user's choice.

Humidity Limits

10 to 100% RH

Turn-on Time

Approximately 10 seconds.

Update Time

Approximately 0.5 second.

Damping

Adjustable 0-32 seconds.

Configuration

This is done by an external Hand-Held Terminal, that communicates with the transmitter remote or locally using Hart Protocol.

Performance Specifications**Accuracy**

See the following tables.

Ambient Temperature Effect

For a 10°C variation:

mV (-6...22 mV), TC (NBS: B, R, S, T): $\pm 0.03\%$ of the input millivoltage or 0.002 mV whichever is greater.

mV (-10...100 mV), TC (NBS: E, J, K, N; DIN: (L, U): $\pm 0.03\%$ of the input millivoltage or 0.01 mV whichever is greater.

mV (-50...500 mV): $\pm 0.03\%$ of the input millivoltage or 0.05 mV whichever is greater.

Ohms (0...100 Ohms), RTD (GE: Cu10) : $\pm 0.03\%$ of the input resistance.

Ohms (0...400 Ohms), RTD (DIN: Ni: 120; IEC: Pt50, Pt100; JIS: Pt50, Pt100): $\pm 0.03\%$ of the input resistance.

Ohms (0...2000 Ohms), RTD (IEC: Pt500; Pt1000): $\pm 0.03\%$ of the input resistance.

TC: Cold-junction compensation rejection 60:1 Reference: 25,0 $\pm 0,3^\circ\text{C}$

Power Supply Effect

$\pm 0.005\%$ of calibrated span per volt.

Vibration Effect

Meets SAMA PMC 31.1

Electro-Magnetic Interference Effect

Designed to comply with IEC 801

Physical Specifications**Electrical Connection**

Accommodates conductors up to 2.5mm² (12 AWG)

Mounting

Industry standard DIN Form B enclosure for easy integration.

CONTROL CHARACTERISTICS (Optional)

PID

Proportional Gain: 0 to 100

Integral Time: 0.01 to 999 min/rep

Derivative Time: 0 to 999 s

Direct/Reverse Action

Lower and Upper output limits: -0.6 to +106.25%

Output rate-of-change limit: 0.02 to 600 %/s

Power-on safety output: -0.6 to +106.25%

Antireset windup

Bumpless Auto/Manual transfer

Setpoint Generator up to 16 points, up to 19999 minutes

Alarm

Dual, trip levels adjustable over entire range.

High or Low action.

Acknowledge, messaging

2, 3 OR 4 WIRES						DIFFERENTIAL			
SENSOR	TYPE	RANGE °C	RANGE °F	MINIMUM SPAN °C	°C DIGITAL ACCURACY	RANGE °C	RANGE °F	MINIMUM SPAN °C	°C DIGITAL ACCURACY
RTD	Cu10 GE	-20 to 250	-4 to 482	50	±1.0	-270 to 270	-486 to 486	50	±2.0
	Ni 120 DIN	-50 to 270	-58 to 518	5	±0.1	-320 to 320	-576 to 576	5	±0.5
	Pt50 IEC	-200 to 850	-328 to 1562	10	±0.2	-1050 to 1050	-1890 to 1890	10	±1.0
	Pt100 IEC	-200 to 850	-328 to 1562	10	±0.2	-1050 to 1050	-1890 to 1890	10	±1.0
	Pt500 IEC	-200 to 450	-328 to 842	10	±0.2	NA	NA	NA	NA
	Pt50 JIS	-200 to 600	-328 to 1112	10	±0.25	-800 to 800	-1440 to 1440	10	±1.0
	Pt100 JIS	-200 to 600	-328 to 1112	10	±0.25	-800 to 800	-1440 to 1440	10	±1.5
	Pt1000 IEC	-200 to 300	-328 to 572	10	±0.25	-500 to 500	-868 to 500	10	±1.5
THERMO-COUPLE	B NBS	+100 to 1800	212 to 3272	50	±0.5**	-1700 to 1700	-3060 to 3060	60	±1.0**
	E NBS	-100 to 1000	-148 to 1832	20	±0.2	-1100 to 1100	-1980 to 1980	20	±1.0
	J NBS	-150 to 750	-238 to 1382	30	±0.3	-900 to 900	-1620 to 1620	30	±0.6
	K NBS	-200 to 1350	-328 to 2462	60	±0.6	-1550 to 1550	-2790 to 2790	60	±1.2
	N NBS	-100 to 1300	-148 to 2372	50	±0.5	-1400 to 1400	-2520 to 2520	50	±1.0
	R NBS	0 to 1750	32 to 3182	40	±0.4	-1750 to 1750	-3150 to 3150	40	±2.0
	S NBS	0 to 1750	32 to 3182	40	±0.4	-1750 to 1750	-3150 to 3150	40	±2.0
	T NBS	-200 to 400	-328 to 752	15	±0.15	-600 to 600	-1080 to 1080	15	±0.8
	L DIN	-200 to 900	-328 to 1652	35	±0.35	-1100 to 1100	-1980 to 1980	35	±0.7
	U DIN	-200 to 600	-328 to 1112	50	±0.5	-800 to 800	-1440 to 1440	50	±2.5
	K DIN - IEC	-200 to 1350	-328 to 2462	60	±0.6	-1550 to 1550	-2758 to 2822	60	±1.2
	S DIN - IEC	0 to 1750	32 to 3182	40	±0.4	-1750 to 1750	-3118 to 3182	40	±2.0

* Accuracy of value accessed by communication using the HPC301 Hand-Held Terminal. The 4-20 mA accuracy is the digital accuracy ±0.03%.

** Not applicable for the first 20% of the range (up to 440 °C).

NA Not applicable.

SENSOR	RANGE mV	MINIMUM SPAN mV	DIGITAL * ACCURACY %		
Special	-50 to 500	10.00	±0.02%	or	±50 µV
mV	-6 to 22	0.40	±0.02%	or	±2 µV
	-10 to 100	2.00	±0.02%	or	±10 µV
	-50 to 500	10.00	±0.02%	or	±50 µV
mV DIF	-28 to 28	0.40	±0.1%	or	±10 µV
	-110 to 110	2.0	±0.1%	or	±10 µV

SENSOR	RANGE OHM	MINIMUM SPAN mV	DIGITAL * ACCURACY %		
Special	0 to 2000	20	±0.02%	or	±0.20 Ohm
OHM	0 to 100	1	±0.02%	or	±0.01 Ohm
	0 to 400	4	±0.02%	or	±0.04 Ohm
	0 to 2000	20	±0.02%	or	±0.20 Ohm
OHM DIF	-100 to 100	1	±0.08%	or	±0.04 Ohm
	-400 to 400	4	±0.1%	or	±0.2 Ohm

ORDERING CODE

MODEL TT421		TEMPERATURE TRANSMITTER	
		CODE	Connection Type
		L2	Two wires
		L3	Three wires (*)
		L4	Four wires
		L5	2 dual wires
		CODE	Sensor Type
		T1	CU10 - GE
		T2	NI120 - DIN
		T3	PT50 - IEC
		T4	PT100 - IEC (*)
		T5	PT500 - IEC
		T6	PT50 - JIS
		T7	PT100 - JIS
		T8	OHM 2K
		T9	OHM 400
		TA	TC Type B - NBS
		TB	TC Type E - NBS
		TC	TC Type J - NBS
		TD	TC Type K - NBS
		TE	TC Type N - NBS
		TF	TC Type R - NBS
		TG	TC Type S - NBS
		TH	TC Type T - NBS
		TI	TC Type TIPO J - DIN
		TJ	TC Type TIPO K - DIN
		TL	TC Type S - DIN
		TM	TC Type T - DIN
		TN	OHM 100
		TO	SPECIAL OHM
		TQ	mV 22
		TR	100 mV
		TS	500 mV
		TT	SPECIAL MV
		CODE	Measured Type
		E1	Simple (*)
		E2	Differential
		E3	Maximum
		E4	Minimum
		E5	Average

TT421	L3	T4	E1	* indicates factory default
-------	----	----	----	-----------------------------

Mechanical Dimensions

Below are the mechanical dimensions of the internal transmitter and BUZ enclosure.

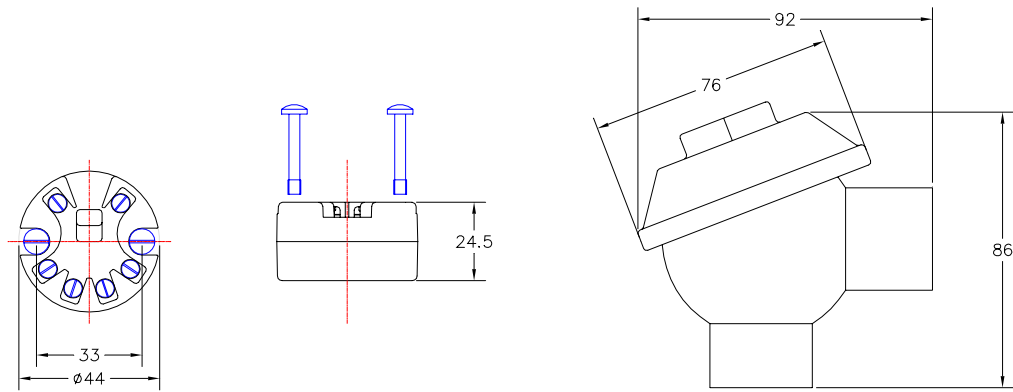

Fig. 3.7 – Mechanical Dimensions



Fig. 3.8 – TT421 Images

Smar Research reserves the right to make changes to design and functionality of any product without notice. Smar Research does not assume any liability arising out of the application or use of any product. Smar Research , Technology Source, and the SRC logo are registered trademarks of Smar Research Corporation. The HART, Fieldbus, and Profibus Foundation logos are trademarks of their respective owners.

Autek AS

Hofgaardsgate 27
3012 Drammen

Tel: +47 32219200 Fax: +47 32219201

mail@autek.no

www.autek.no



© Smar Research Corporation



31



TT421MAN - 1104