

TOSHIBA

Leading Innovation >>>



A09-002

AIR TO WATER HEAT PUMP SERVICE MANUAL



Model name: _____

Hydro Unit

HWS-802XWHM3-E

HWS-802XWHT6-E

HWS-1402XWHM3-E

HWS-1402XWHT6-E

HWS-1402XWHT9-E

Outdoor Unit

HWS-802H-E

HWS-1102H-E

HWS-1402H-E

Hot Water Cylinder

HWS-1501CSHM3-E(-UK)

HWS-2101CSHM3-E(-UK)

HWS-3001CSHM3-E(-UK)

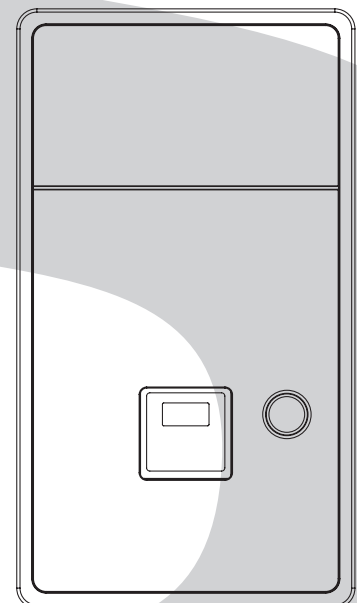

Contents



1	SAFETY PRECAUTIONS	3
2	NEW REFRIGERANT (R410A)	6
2-1.	Safety During Installation and Service	6
2-2.	Installing refrigerant pipe	7
2-2-1.	Steel pipe and joint	7
2-2-2.	Processing of piping materials	8
2-3.	Tools	10
2-3-1.	Necessary tools	10
2-4.	Recharging of refrigerant	11
2-5.	Brazing of pipes	13
2-5-1.	Materials of brazing	13
2-5-2.	Flux	13
2-5-3.	Brazing	13
3	Specifications	15
4	Outside Drawing	17
4-1.	Hydro unit	17
4-2.	Outdoor unit	18
4-3.	Hot water cylinder	20
5	Wiring Diagram	21
5-1.	Hydro Unit	21
5-2.	Outdoor Unit	22
5-3.	Hot Water Cylinder Unit	23
6	Key Electric Component Rating	24
6-1.	Hydro Unit	24
6-2.	Outdoor Unit	26
6-3.	Hot Water Cylinder Unit	28
6-4.	Water Heat Exchange Control Board	29
6-5.	Outdoor Control Board	30
7	Refrigeration Cycle / Water System Diagram	32
7-1.	Water System Diagram	32
7-2.	Refrigeration Cycle System Diagram	34
8	Operational Description	35

9 Method of Defect Diagnosis	64
9-1.Matters to be confirmed first	65
9-1-1.Check the power supply voltage	65
9-1-2.Check for any miswiring of the connection cables between the hydro unit and the outdoor unit	65
9-1-3.About the installation of the temperature sensor	65
9-2.Non-defective operation (program operation) ... No fault code display appears	65
9-3.Outline of the determination diagram	66
9-3-1.Procedure of defect diagnosis	66
9-3-2.How to determine from the check code on the remote control	66
9-3-3.How to cancel a check code on the remote controller	66
9-3-4.How to diagnose by error code	67
9-4.Diagnosis flow chart for each error code	74
9-4-1.Hydro unit failure detection	74
9-4-2.Outdoor Unit Failure Detection	91
9-4-3.Temperature sensor, temperature-resistance characteristic table	101
9-5.Operation check by PC board switch	102
9-5-1.Operation check mode	102
9-6.Brief method for checking the key components	103
9-6-1.Hydro unit	103
9-6-2.Outdoor unit	104
10 Hydro unit and Outdoor Unit Settings	105
11 How to Exchange Main Parts	127
12 Periodic Inspection Items	154
13 Part Exploded View, Part List	155

1 SAFETY PRECAUTIONS



The unit and this service guide list very important safety precautions. Understand the following details (indications and symbols) before reading the body text, and follow the instructions.

[About indication]

Indication	Meaning of Indication
 DANGER	Indicates that a wrong operation may cause a service engineer and the third persons around to get fatal or serious injuries.
 WARNING	Indicates that a wrong operation may cause a service engineer and the third persons around to get fatal or serious injuries, or that unit defective after the operation may cause a user to have a similar serious accident.
 CAUTION	Indicates that a wrong operation may cause a service engineer and the third persons around to get injuries or may cause property damage*, or that unit defective after the operation may cause a user to have a similar accident.

* Property damage indicates extended damage to property, furniture, livestock, or pets.

[About symbols]

Symbols	Meaning of Symbols
	Indicates a forbidden action. Specific forbidden actions are described in text near the symbol.
	Indicates a forcible (must do) action. Specific forcible actions are described in text near the symbol.
	Indicates a caution (including danger and warning). Specific cautions are described in picture or text inside or near the symbol.

DANGER

<Turn off the power breaker>

Turn off the power breaker before removing the front panel and cabinet.

- Failure to do so may cause a high voltage electric shock, leading to death or injury.
- During an operation, the second side circuit of high pressure transmission(*) are applied with a high voltage of 230V or higher.
- Touching the circuit even with an electrical insulator, let alone a bare hand or body, causes an electric shock.

*: For details, see the schematic.

<Discharge between terminals>

When the front panel and cabinet are removed, make short-circuit current to discharge between high pressure capacitor terminals.

- Failure to do so may cause a high voltage electric shock, leading to death or injury.
- After the power is turned off, the high pressure capacitor is still charged with high voltage.

<Forbidden>

Do not turn on the power breaker after removing the front panel cabinet.

- Failure to do so may cause a high voltage electric shock, leading to death or injury.

WARNING

<Check earth ground>

Before starting failure diagnosis or repair, check that the ground wire (*) is connected to the unit ground terminal.

- An unconnected ground wire could cause an electric shock if electric leakage occurs.
- If the earth ground is not properly connected, ask an electrical worker for rework of the ground connection.

*: Ground wire of class D grounding

 **WARNING**

<No modification>

Do not modify the unit.

- Do not disassemble or modify the parts also.
- A fire, an electric shock, or an injury may occur.

<Use specified parts>

Use the specified parts (*) when replacing them.

- Using parts other than specified ones may cause a fire or an electric shock.

*: For details, see the parts price list.

<Keep children away from unit>

Keep any person (including children) other than service engineers away from a failure diagnosis or repairing place.

- A tool or disassembled parts may cause an injury.
- Advise the customer to keep the third persons (including children) away from the unit.

<Insulation treatment>

After connecting a cut lead with a crimp contact, discharge by facing the closed side upward.

- Connect lead wires with crimping terminals and turn the closed end upwards to avoid exposure to water.

<Watch out for fire>

Observe the following instructions when repairing the refrigerant cycle.

- (1) Watch out for surrounding fire. Always put out the fire of stove burner or other devices before starting the repair.
Should the fire fail to be put out, the oil mixed with refrigerant gas could catch fire.
- (2) Do not use a welder in a closed room.
A room with no ventilation may cause carbon monoxide poisoning.
- (3) Keep away flammable materials.
The materials may catch the fire of a welder.

<Use refrigerant carefully>

Check the refrigerant name to use the tools and members appropriate for the refrigerant.

- A product using the refrigerant R410A has the refrigerant name prominently displayed on its outdoor unit. In addition, the diameter of the service port is changed from that of the conventional R22 to prevent incorrect filling.

Never use refrigerant other than R410A for Air to Water Heat Pump using R410A. Also, never use R410A for Air to Water Heat Pump using other refrigerant (such as R22).

- A mixture of R410A with different ones excessively raises the pressure in the refrigerant cycle, leading to an injury due to burst.

Do not make additional charge of the refrigerant.

- An additional charge when refrigerant gas leaks changes the refrigerant composition in the refrigerant cycle, causing the characteristics change of the Air to Water Heat Pump or excessive high pressure in the refrigerant cycle with more than the specified amount of refrigerant charged. This may cause burst or an injury. If the refrigerant gas leaks, perform refrigerant recovery or other operation to make the Air to Water Heat Pump contain no refrigerant, and then perform vacuuming. After that, refill the unit with the defined amount of liquid refrigerant. Never charge refrigerant exceeding the amount specified.

When the refrigerant cycle is refilled with refrigerant, do not enter air or refrigerants other than the specified refrigerant, R410A.

- A mixture of R410A with air or an inappropriate substance causes excessive high pressure inside the refrigerant cycle, leading to an injury due to burst.

Check that there is no refrigerant gas leak after the installation is completed.

- If it catches fire of a fan heater, a space heater, or a stove, poisonous gases may be produced.

<Be careful with wiring>

After a repair is completed, be sure to reassemble the parts and put the wiring back to its original state. In addition, be careful with the internal wiring not to be caught in a cabinet or panel.

- A defective assembly or wiring may cause a disaster at a customer site due to electrical leakage or a fire.

<Check for water leak>

After the repair of a water pathway is completed, check that there is no water leak.

- In using the product, water leak may cause a fire at a customer site due to electrical leakage or an electric shock.

 **WARNING**

<Check insulation>

After the work is completed, check with an insulating-resistance tester (500V) that the insulation resistance between the live and dead-metal parts is 2 MΩ or higher.

- A low insulation resistance may cause a disaster at a customer site due to electrical leakage or an electric shock.

<Ventilate>

Ventilate if refrigerant gas leaks during service work.

- Should refrigerant gas catch fire, poisonous gases may be produced. A closed room full of leaking refrigerant results in the absence of oxygen; it is dangerous. Make sure to ventilate.

<Caution: electric shock>

When checking a circuit while energized if necessary, use rubber gloves not to contact the live part.

- Contact with the live part may cause an electric shock.
- The unit contains high-voltage circuits. Contact with a part in the control board with your bare hand may cause an electric shock. Take enough care to check circuits.

<Turn off the power breaker>

Because the electrical components are energized with high voltage, always turn off the power breaker before starting to work.

- Failure to do so may cause an electric shock.

<Always do>

Should refrigerant gas leak, find where the gas leaks and properly repair it.

- To stop the repair work because the leakage location cannot be identified, perform refrigerant recovery and close the service valve. Failure to do so may cause the refrigerant gas to leak in a room. Although refrigerant gas alone is harmless, if it catches fire of a fan heater, a space heater, or a stove, poisonous gases may be produced.

When installing the unit or re-installing it after relocation, follow the installation guide for proper operation.

- A defective installation may cause a refrigerant cycle defective, a water leak, an electric shock, or a fire.

<Check after repair>

After a repair is completed, check for any abnormality.

- Failure to do so may cause a fire, an electric shock, or an injury.
- Turn off the power breaker to perform check.

After a repair is completed (and the front panel and cabinet are placed), make a test run to check for any abnormality such as smoke or abnormal sound.

- Failure to do so may cause a fire or an electric shock. Place the front panel and cabinet before making a test run.

<Check after re-installation>

Check that the following are properly performed after re-installation.

- (1) The ground wire is properly connected.
 - (2) The installation is stable without any tilt or wobbles.
- Failure to check them may cause a fire, an electric shock, or an injury.

 **CAUTION**

<Wear gloves>

Wear gloves (*) when performing repair.

- Failure to do so may cause an injury when accidentally contacting the parts.

*: Thick gloves such as cotton work gloves

<Cooling check>

Perform service work when the unit becomes cool enough after the operation.

- High temperature of compressor piping or other equipment after a cooling or heating operation may cause burn.

<Tighten with torque wrench>

Tighten a flare nut with a torque wrench in the specified method.

- A flare nut tightened too much might crack after a long period, causing refrigerant leak.

2 NEW REFRIGERANT (R410A)

This Air to Water Heat Pump adopts a new refrigerant HFC (R410A) to prevent destruction of the ozone layer. The working pressure of R410A refrigerant is 1.6 times higher than that of the conventional refrigerant R22. The refrigerant oil is also changed for the new refrigeration. Therefore, during installation or service work, be sure that water, dust, former refrigerant, or refrigeration machine oil does not enter the refrigerant cycle of the new type refrigerant Air to Water Heat Pump. A wrong installation or service operation may cause a serious accident. Read carefully the following instructions to use the tools or members for R410A for safety work.

2-1. Safety During Installation and Service

- Use only the refrigerant R410A for Air to Water Heat Pump using R410A.
A mixture of R410A with different ones excessively raises the pressure in a refrigerant cycle, leading to an injury due to burst.
- Check the refrigerant name to use the tools and members appropriate for the refrigerant.
A product using the refrigerant R410A has the refrigerant name prominently displayed on its outdoor unit. In addition, the diameter of the service port is changed from that of the conventional R22 to prevent incorrect filling.
- Ventilate if refrigerant gas leaks during service work.
Should refrigerant gas catch fire, poisonous gases may be produced. A closed room full of leaking refrigerant results in the absence of oxygen; it is dangerous. Make sure to ventilate.
- When the refrigerant cycle is refilled with refrigerant, do not mix air or refrigerants other than the specified refrigerant, R410A.
A mixture of R410A with air or an inappropriate substance causes excessive high pressure inside the refrigerant cycle, leading to an injury due to burst.
- Check that no refrigerant gas leaks after the installation is completed.
Should a refrigerant gas leak in a room and catch fire, poisonous gases may be produced.
- When installing the unit that contains large amount of refrigerant such as Air to Water Heat Pump, take measures to prevent the refrigerant from exceeding the threshold concentration in case it leaks.
Should leaking refrigerant exceed the threshold concentration could cause an accident due to oxygen deficient.
- When installing the unit or re-installing it after relocation, follow the installation guide for proper operation.
A defective installation may cause a refrigerant cycle defective, a water leak, an electric shock, or a fire.
- Do not modify the product. Do not disassemble or modify the parts also.
A fire, an electric shock, or an injury may occur.

2-2. Installing refrigerant pipe

2-2-1. Steel pipe and joint

For refrigerant piping, steel pipe and joints are mainly used. Select those comply with JIS (Japanese Industrial Standards) for a service work. Also, use such clean piping materials that less impurities attach to the inside of pipe and joints.

Copper pipe

Use copper pipe of the “copper and copper alloy seamless pipe” type with attach oil quantity of 40 mg / 10 m or less. Do not use pipe that is cracked, distorted, or discolored (especially inside). The expansion valve or capillary may get clogged with impurities.

Considering that Air to Water Heat Pump using R410A is higher in pressure than those using the conventional R22, be sure to select the material that comply with the standard.

Table 2-1 shows the thickness of copper pipe used for R410A.

Never use commercially available thin-walled copper pipe of 0.8 mm thick or less.

Table 2-1 Wall thickness of copper pipe

		Wall thickness (mm)
Nominal diameter	Outer diameter	R410A
3/8	9.52	0.80
5/8	15.88	1.00

Joints

For the joint of copper pipe, flared joint and socket joint are used. Remove impurities from a joint before using it.

- **Flared joint**

A flared joint cannot be used for the copper pipe whose outer diameter is 20 mm or larger. A socket joint can be used instead in that case.

Table 2-2-3 and 2-2-4 show the dimensions of flare pipe, the end of flared joint, and flare nuts.

- **Socket joint**

A socket joint is used to connect the thick-walled pipe of mainly 20 mm or larger in diameter.

Table 2-2 shows the wall thickness of socket joints.

Table 2-2 The minimum wall thickness of socket joints

Nominal diameter	Reference of outer diameter of copper pipe connected (mm)	Minimum joint wall thickness (mm)
3/8	9.52	0.80
5/8	15.9	1.00

2-2-2. Processing of piping materials

When installing refrigerant pipe, prevent water or dust from entering the pipe, and do not use oil other than lubricant used for Air to Water Heat Pump. Make sure that no refrigerant leak occurs.

If piping needs lubrication, use lubricating oil whose water content is removed.

After the oil is put in, be sure to seal the container with airproof cover or other covers.

Flare and precautions

1) Cut a pipe.

Cut slowly with a pipe cutter so that the pipe is not distorted.

2) Remove burr and flaw.

A burr or flaw in a flare part may cause refrigerant leak. Remove carefully all the burrs, and clean up the cut ends before installation.

3) Insert a flare nut.

4) Flare

Check that the clamps and copper pipe are clean. Flare correctly using the clamp. Use a flare tool for R410A or the conventional one. Flare processing dimension varies depending on the flare tool type. When using the conventional flare tool, use a gauge for size adjustment to secure the A dimension.

**Figure 2-2-1
Flare dimension**

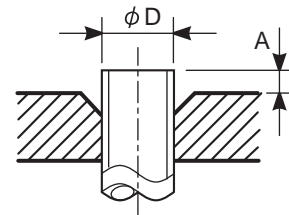

Table 2-2-3 Flare processing related dimension for R410A

Nominal diameter	Outer diameter (mm)	Wall thickness (mm)	A (mm)		
			Flare tool for R410A clutch type	Conventional flare tool	
				Clutch type	Butterfly-nut type
3/8	9.52	0.8	0 to 0.5	1.0 to 1.5	2.0 to 2.5
5/8	15.9	1.0	0 to 0.5	1.0 to 1.5	2.0 to 2.5

Table 2-2-4 Dimension of flare for R410A and flare nut

Nominal diameter	Outer diameter (mm)	Wall thickness (mm)	Dimension (mm)				Flare nut width (mm)
			A	B	C	D	
3/8	9.52	0.8	13.0	13.2	9.7	20	18
5/8	15.9	1.0	19.1	19.7	15.9	24.5	26

Figure 2-2-2 Relationship between flare nut and flare surface

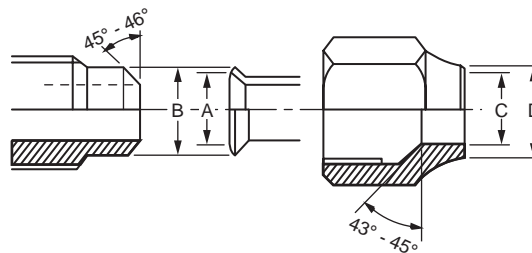

Flare connecting procedure and precautions

- 1) Make sure that the flare and connecting portions do not have any flaw and dust.
- 2) Correctly align the flared surface and the connecting axis.
- 3) Tighten the flare with designated torque by means of a torque wrench. The tightening torque for R410A is the same as that for the conventional R22. If the torque is weak, gas leakage may occur. If it is too strong, the flare nut may crack and may be made non-removable. When choosing the tightening torque, comply with values designated by products. Table 2-2-5 shows reference values.

NOTE

When applying oil to the flare surface, be sure to use oil designated by the product. Using any other oil deteriorates the lubricating oil, possibly causing the compressor to burn out.

Table 2-2-5 Tightening torque of flare for R410A (Reference values)

Nominal diameter	Outer diameter (mm)	Tightening torque N•m (kgf•m)
3/8	9.52	33 to 42 (3.3 to 4.2)
5/8	15.9	66 to 82 (6.8 to 8.2)

2-3. Tools

2-3-1. Necessary tools

In Air to Water Heat Pump using R410A, the service port diameter of packed valve of the outdoor unit is changed to prevent mixing of other refrigerant. To reinforce the pressure resistance, flare dimensions and opposite side dimensions of flare nut (For Ø 12.7 copper pipe) of the refrigerant piping are lengthened.

Because the refrigerating machine oil is changed, mixing of oil may generate sludge, clog capillary, or cause other problems. Accordingly, the tools to be used include:

- tools dedicated for R410A (Those that cannot be used for the conventional refrigerant, R22)
- tools dedicated for R410A, but can be also used for the conventional refrigerant, R22
- tools that can be used for the conventional refrigerant, R22.

The following table shows the tools dedicated for R410A and their interchangeability.

Tools dedicated for R410A (The following tools must be for R410A)

Tools whose specifications are changed for R410A and their interchangeability

No.	Tool to be used	Usage	R410A Air to Water Heat Pump installation		Conventional refrigerant Air to Water Heat Pump installation
			For R410A Existence of new equipment	Conventional equipment can be used	New equipment can be used with conventional refrigerant
1	Flare tool	Pipe flaring	Yes	*(Note 1)	Yes
2	Copper pipe gauge for adjusting projection margin	Flaring by conventional flare tool	Yes	*(Note 1)	*(Note 1)
3	Torque wrench (For Ø15.9)	Connection of flare nut	Yes	No	No
4	Gauge manifold	Evacuating, refrigerant charge, run check, etc.	Yes	No	No
5	Charge hose				
6	Vacuum pump adapter	Vacuum evacuating	Yes	No	Yes
7	Electrical balance for refrigerant charging	Refrigerant charge	Yes	No	Yes
8	Refrigerant cylinder	Refrigerant charge	Yes	No	No
9	Leakage detector	Gas leakage check	Yes	No	Yes
10	Charging cylinder	Refrigerant charge	*(Note 2)	No	No

* **(Note 1)** Flaring for R410A by using the conventional flare tool requires projection margin adjustment. This adjustment requires copper pipe gauge or other instrument.

* **(Note 2)** A charging cylinder for R410A is currently under development.

General tools (Conventional tools are available)

In addition to the above dedicated tools, the following equipment also available for R22 is necessary as the general tools.

- | | | |
|--|-----------------------------|---|
| 1. Vacuum pump
Use this by attaching vacuum pump adapter. | 4. Reamer | 9. Hole core drill (Ø65) |
| 2. Torque wrench (For Ø6.35) | 5. Pipe bender | 10. Hexagon wrench
(Opposite side 4mm) |
| 3. Pipe cutter | 6. Level vial | 11. Tape measure |
| | 7. Screwdriver (+, -) | 12. Metal saw |
| | 8. Spanner or Monkey wrench | |

Also prepare the following equipment for other work methods or run check.

- | | |
|----------------|--------------------------------|
| 1. Clamp meter | 3. Insulation resistance meter |
| 2. Thermometer | 4. Electroscop |

2-4. Recharging of refrigerant

Recharge, if necessary, the specified amount of new refrigerant according to the following procedure.

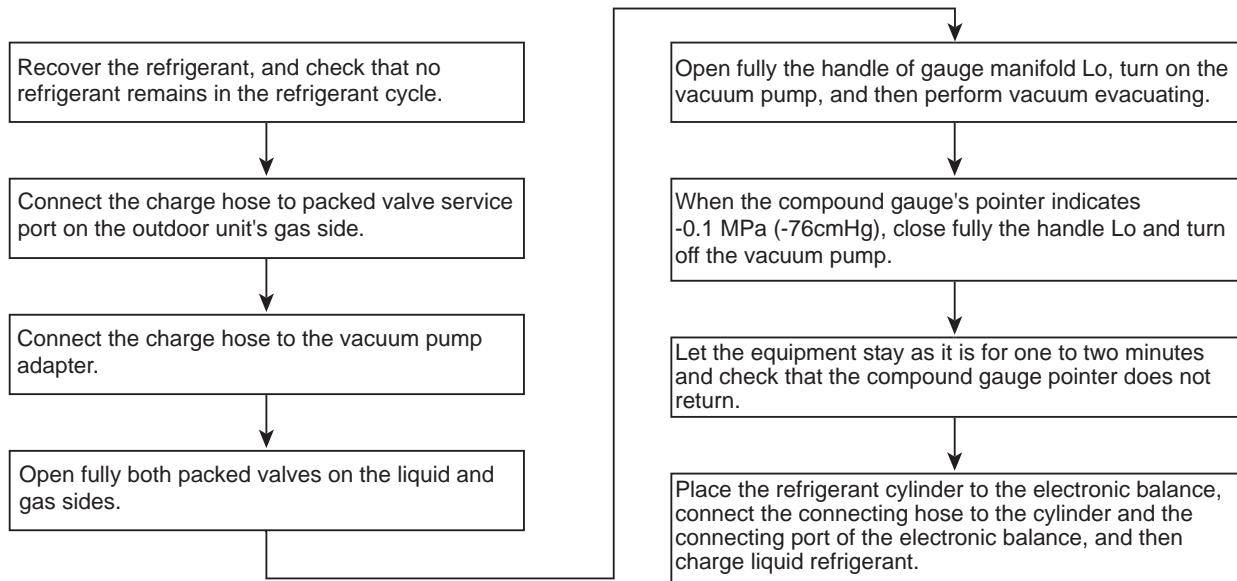

(For refrigerant charging, see the figure below)

NOTE

- Never charge refrigerant exceeding the specified amount.
- If the specified amount of refrigerant cannot be charged, charge it a little at a time while running refrigerant recovery (pump down).
- Do not make additional charging.
An additional charge when refrigerant leaks changes the refrigerant composition in the refrigerant cycle, causing the characteristics change of the Air to Water Heat Pump or excessive high pressure in the refrigerant cycle with more than the specified amount of refrigerant charged. This may cause burst or an injury.

Fig. 2-4-1 Configuration of refrigerant charging

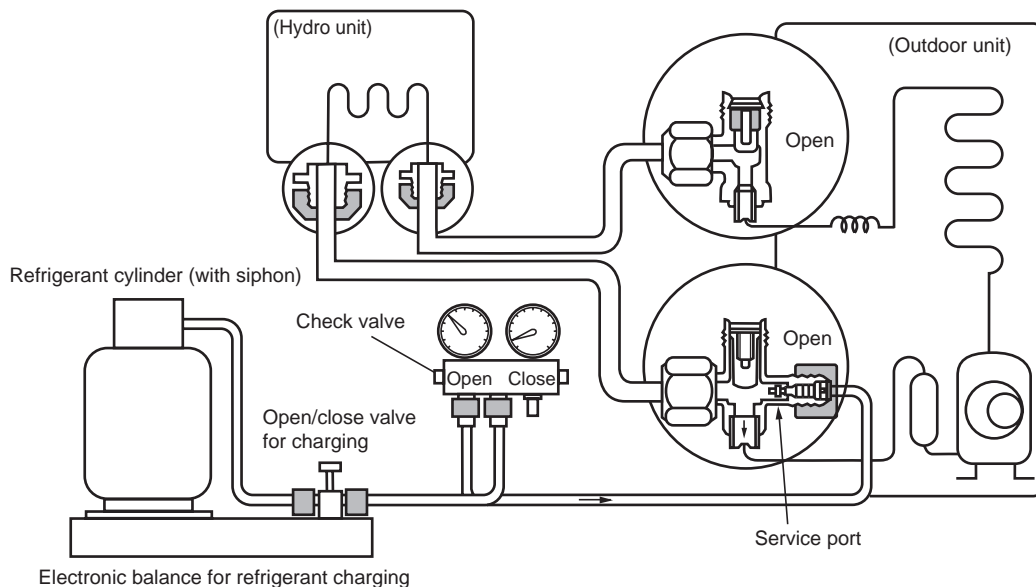

NOTE

- Make sure that the setting is appropriate so that liquid can be charged.
- A cylinder with siphon enables liquid to be charged without the cylinder turned upside down.

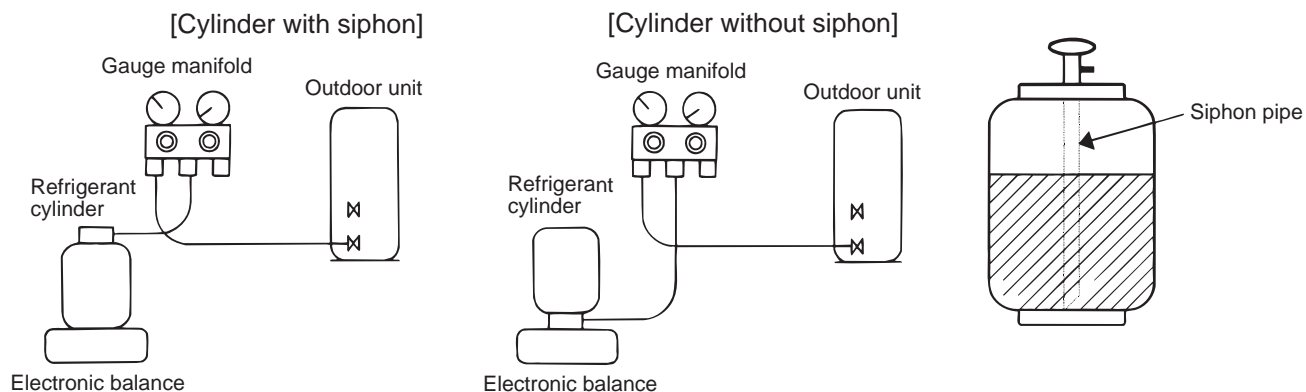

NOTE

- Because R410A is HFC mixed refrigerant, charging with gas changes the charged refrigerant composition, causing the equipment characteristics to change.

2-5. Brazing of pipes

2-5-1. Materials of brazing

Silver brazing metal

Silver brazing metal is an alloy mainly composed of silver and copper.

It uses iron, copper, or copper alloy, and is relatively expensive though it excels in soldering.

Phosphor bronze brazing metal

Phosphor bronze brazing metal is generally used to join copper or copper alloy.

Low temperature brazing metal

Low temperature brazing metal is generally called solder, and is an alloy of tin and lead. Do not use it for refrigerant piping because its adhesive capacity is low.

NOTE

- Phosphor bronze brazing metal tends to react with sulfur, producing a fragile compound water solution. This may cause gas leakage. Therefore, use other type of brazing metal at a hot spring resort or similar place, and coat the surface with coatings.
- To braze the pipe again while performing service work, use the same type of brazing metal.

2-5-2. Flux

Why flux is necessary

- Removing all the oxide film and any foreign matter on the metal surface assists the flow of brazing metal.
- Flux prevents the metal surface from being oxidized in the course of brazing.
- Reducing the brazing metal's surface tension enables the brazing metal to adhere for better metal processing.

Characteristics of flux

- The activation temperature of flux matches the brazing temperature.
- A wide effective temperature range makes flux hard to carbonize.
- It is easy to remove slag after brazing.
- The corrosive action to the treated metal and brazing metal is minimum.
- The good performance of flux gives no harm to a human body.

Since flux works in a complicated manner as described above, select an appropriate type of flux according to metal treatment type, brazing metal and brazing method, or other conditions.

Type of flux

- Non-corrosive flux
It is generally a compound of borax and boric acid. It is effective when brazing temperature is higher than 800 °C.
- Active solvent
Most of this type of flux is generally used for silver brazing.
It features the increase of oxide film while moving the capability to the borax-boric acid compound to add compounds such as potassium fluoride, potassium chloride, or sodium fluoride.

Piping materials for brazing and brazing metal / flux

Piping material	Brazing metal to be used	Flux to be used
Copper - Copper	Phosphor copper	Do not use
Copper - Iron	Silver	Paste flux
Iron - Iron	Silver	Vapour flux

NOTE

- Do not enter flux into the refrigerant cycle.
- If chlorine contained in the flux remains within the pipe, the lubricating oil deteriorates. Because of this, use a flux that does not contain chlorine.
- When adding water to the flux, use water that does not contain chlorine. (e.g. distilled water or ion-exchange water)
- Remove the flux after brazing.

2-5-3. Brazing

Brazing must be performed by a person qualified and experienced with theoretical knowledge since the operation requires sophisticated techniques. Perform brazing while flowing dry nitrogen gas (N₂) to prevent oxide film from forming during brazing application to the inside of the pipe.

NOTE

- Never use gas other than nitrogen gas.

Brazing method to prevent oxidation

- 1) Attach a reducing valve and a flow meter to the nitrogen cylinder.
- 2) Use a copper pipe to direct the piping material, and attach the flow meter to the balance.
- 3) Apply a mark to the clearance between the piping material and the copper pipe filled with nitrogen to prevent the back flow of the nitrogen gas.
- 4) If the nitrogen gas flows out, be sure to keep open the piping end.

- 5) Use the reducing valve to adjust the nitrogen gas flow speed to 0.05 m³/hour or 0.02 MPa (0.2 kgf/cm²).
- 6) After the steps above, keep the nitrogen gas flowing until the pipe cools down to a certain extent. (Temperature where the pipe is cool enough to be touched by hands)
- 7) Remove the flux completely after brazing.

Fig 2-5-1
Prevention of oxidation during brazing

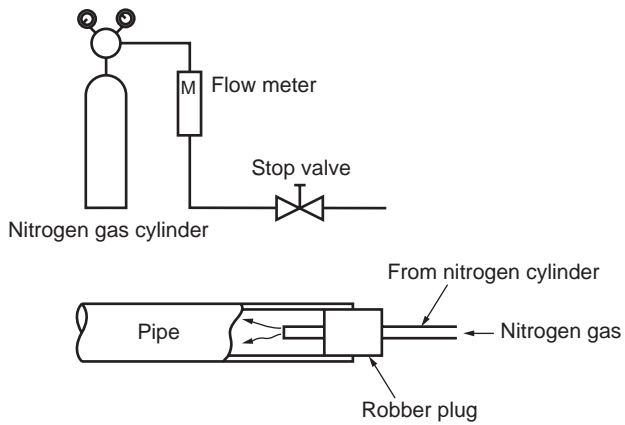

3 Specifications

Unit name	Hydro unit	HWS-802XWHM3-E, 802XWHT6-E			
	Outdoor unit	HWS-802H-E			
Heating capacity *1 (kW)	8.0				
Cooling capacity *2 (kW)	6.0				
Variable range of compressor frequency	10 - 70 Hz				
Power source	Single phase 50Hz 230V				
Operation mode			Heating	Cooling	
Electric characteristic *1 *2	Hydro unit	Current (A)	0.98	0.46	
		Power (kW)	0.101	0.097	
		Power factor (%)	91.5	91.7	
	Outdoor unit	Current (A)	8.26	8.90	
		Power (kW)	1.859	2.033	
		Power factor (%)	97.8	99.3	
Total	Starting current (A)	9.24	9.36		
Operating noise *1 *2 *4	Hydro unit (dB(A))		29	29	
	Outdoor unit (dB(A))		49	49	
Coefficient of performance *1 *2			4.08	2.82	
Hydro unit	Outer dimension	Height (mm)	925		
		Width (mm)	525		
		Depth (mm)	355		
	Net weight (kg)		50		
	Color		Silky shade (Munsell 1Y8.5/0.5)		
	Remote controller Outer dimension *3	Height (mm)	120		
		Width (mm)	120		
		Depth (mm)	20		
	Circulating pump	Motor output (W)	125 (MAX)		
		Flow rate (L/min)	22.9	17.2	
		Type	Non-self-suction centrifugal pump		
Heat exchanger		Plate-type heat exchange			
Outdoor unit	Outer dimension	Height (mm)	890		
		Width (mm)	900		
		Depth (mm)	320		
	Net weight (kg)		63		
	Color		Silky shade (Munsell 1Y8.5/0.5)		
	Compressor	Motor output (W)	1400		
		Type	Twin rotary type with DC-inverter variable speed control		
		Model	DA220A2F-22L		
	Fan motor	Standard air capacity (m ³ /min)	50.0		
		Motor output (W)	60		
Refrigerant piping	Connection method		Flare connection		
	Hydro unit	Liquid	Ø9.52		
		Gas	Ø15.9		
	Outdoor unit	Liquid	Ø9.52		
		Gas	Ø15.9		
	Maximum length (m)		30		
	Maximum chargeless length (m)		30		
	Maximum height difference (m)		±30		
Minimum length (m)		5			
Refrigerant	Refrigerant name		R410A		
	Charge amount (kg)		1.8		
Water piping	Pipe diameter		R1 1/4		
	Maximum length (m)		None (Need the flow rate 17.5ℓ/min or more)		
	Maximum height difference (m)		±7		
	Maximum working water pressure (kPa)		300		
Operating temperature range	Hydro unit (°C)		5-32		
	Outdoor unit (°C)		-20-43		
Operating humidity range	Hydro unit (%)		15-85		
	Outdoor unit (%)		15-100		
Wiring connection	Power wiring		3 wires: including ground line (Outdoor unit)		
	Connecting line		4 wires: including ground line		

*1 Heating performance measurement conditions: outside air temperature 7 or 6 °C, water supply temperature 30 °C, outlet temperature 35 °C, refrigerant piping length 7.5 m (no height difference), capacity ≥ 97%, COP ≥ 95%, operating noise ≤ +3 dB

*2 Cooling performance measurement conditions: outside air temperature 35 °C, water supply temperature 12 °C, outlet temperature 7 °C, refrigerant piping length 7.5 m (no height difference), capacity ≥ 97%, COP ≥ 95%, operating noise ≤ +3 dB

*3 • The remote controller should be shipped with the hydro unit.

• Use two 1.5-meter wires to connect the hydro unit with the remote controller.

*4 The outdoor unit operating noise is measured at the point of 1m away from the unit back surface center and 1m high from the ground. The hydro unit operating noise is measured at the point of 1m away from the unit front surface center.

The value of the operating noise varies depending on room structure where the unit is installed.

*5 Do not leave the hydro unit at 5 °C or below.

*6 Check the water piping for leakage under the maximum operating pressure.

Unit name	Hydro unit	HWS-1402XWHM3-E, 1402XWHT6-E, 1402XWHT9-E				
	Outdoor unit	HWS-1102H-E		HWS-1402H-E		
Heating capacity *1 (kW)			11.2		14.0	
Cooling capacity *2 (kW)			10.0		11.0	
Variable range of compressor frequency			10 - 60Hz		10 - 70 Hz	
Power source	Single phase 50Hz 230V					
Operation mode			Heating	Cooling	Cooling	
Electric characteristic *1 *2	Hydro unit	Current (A)	0.63	0.61	0.67	0.63
		Power (kW)	0.135	0.130	0.145	0.135
		Power factor (%)	93.2	92.7	94.0	93.2
	Outdoor unit	Current (A)	10.14	14.88	13.57	17.47
		Power (kW)	2.265	3.39	3.005	3.945
		Power factor (%)	96.9	99.1	96.4	98.1
	Total	Starting current (A)	10.77	15.49	14.24	18.10
Operating noise *1 *2 *4	Hydro unit (dB(A))		29	29	29	29
	Outdoor unit (dB(A))		49	49	51	51
Coefficient of performance *1 *2			4.66	2.84	4.45	2.69
Hydro unit	Outer dimension	Height (mm)	925			
		Width (mm)	525			
		Depth (mm)	355			
	Net weight (kg)		54			
	Color		Silky shade (Munsell 1Y8.5/0.5)			
	Remote controller Outer dimension *3	Height (mm)	120			
		Width (mm)	120			
		Depth (mm)	20			
	Circulating pump	Motor output (W)	190 (MAX)			
		Flow rate (L/min)	32.1	28.9	40.1	31.5
		Type	Non-self-suction centrifugal pump			
Heat exchanger		Plate-type heat exchange				
Outdoor unit	Outer dimension	Height (mm)	1340			
		Width (mm)	900			
		Depth (mm)	320			
	Net weight (kg)		90			
	Color		Silky shade (Munsell 1Y8.5/0.5)			
	Compressor	Motor output (W)	2500			
		Type	Twin rotary type with DC-inverter variable speed control			
		Model	DA422A3F-25M			
	Fan motor	Standard air capacity (m ³ /min)	103.0			
		Motor output (W)	100 × 2			
	Refrigerant piping	Connection method	Flare connection			
Hydro unit		Liquid	Ø9.52			
		Gas	Ø15.9			
Outdoor unit		Liquid	Ø9.52			
		Gas	Ø15.9			
Maximum length (m)		30				
Maximum chargeless length (m)		30				
Maximum height difference (m)		±30				
Minimum length (m)		3				
Refrigerant	Refrigerant name	R410A				
	Charge amount (kg)	2.7				
Water piping	Pipe diameter	R1 1/4				
	Maximum length (m)	None (Need the flow rate 13ℓ/min or more)				
	Maximum height difference (m)	±7				
	Maximum working water pressure (kPa)	300				
Operating temperature range	Hydro unit (°C)	5-32				
	Outdoor unit (°C)	-20-43				
Operating humidity range	Hydro unit (%)	15-85				
	Outdoor unit (%)	15-100				
Wiring connection	Power wiring	3 wires: including ground line (Outdoor unit)				
	Connecting line	4 wires: including ground line				

- *1 Heating performance measurement conditions: outside air temperature 7 or 6 °C, water supply temperature 30 °C, outlet temperature 35 °C, refrigerant piping length 7.5 m (no height difference), capacity \geq 97%, COP \geq 95%, operating noise \leq +3 dB
- *2 Cooling performance measurement conditions: outside air temperature 35 °C, water supply temperature 12 °C, outlet temperature 7 °C, refrigerant piping length 7.5 m (no height difference), capacity \geq 97%, COP \geq 95%, operating noise \leq +3 dB
- *3 • The remote controller should be shipped with the hydro unit.
• Use two 1.5-meter wires to connect the hydro unit with the remote controller.
- *4 The outdoor unit operating noise is measured at the point of 1m away from the unit back surface center and 1m high from the ground. The hydro unit operating noise is measured at the point of 1m away from the unit front surface center.
The value of the operating noise varies depending on room structure where the unit is installed.
- *5 Do not leave the hydro unit at 5 °C or below.
- *6 Check the water piping for leakage under the maximum operating pressure.

4 Outside Drawing

4-1. Hydro unit

HWS-802XWHM3-E, 802XWHT6-E

HWS-1402XWHM3-E, 1402XWHT6-E, 1402XWHT9-E

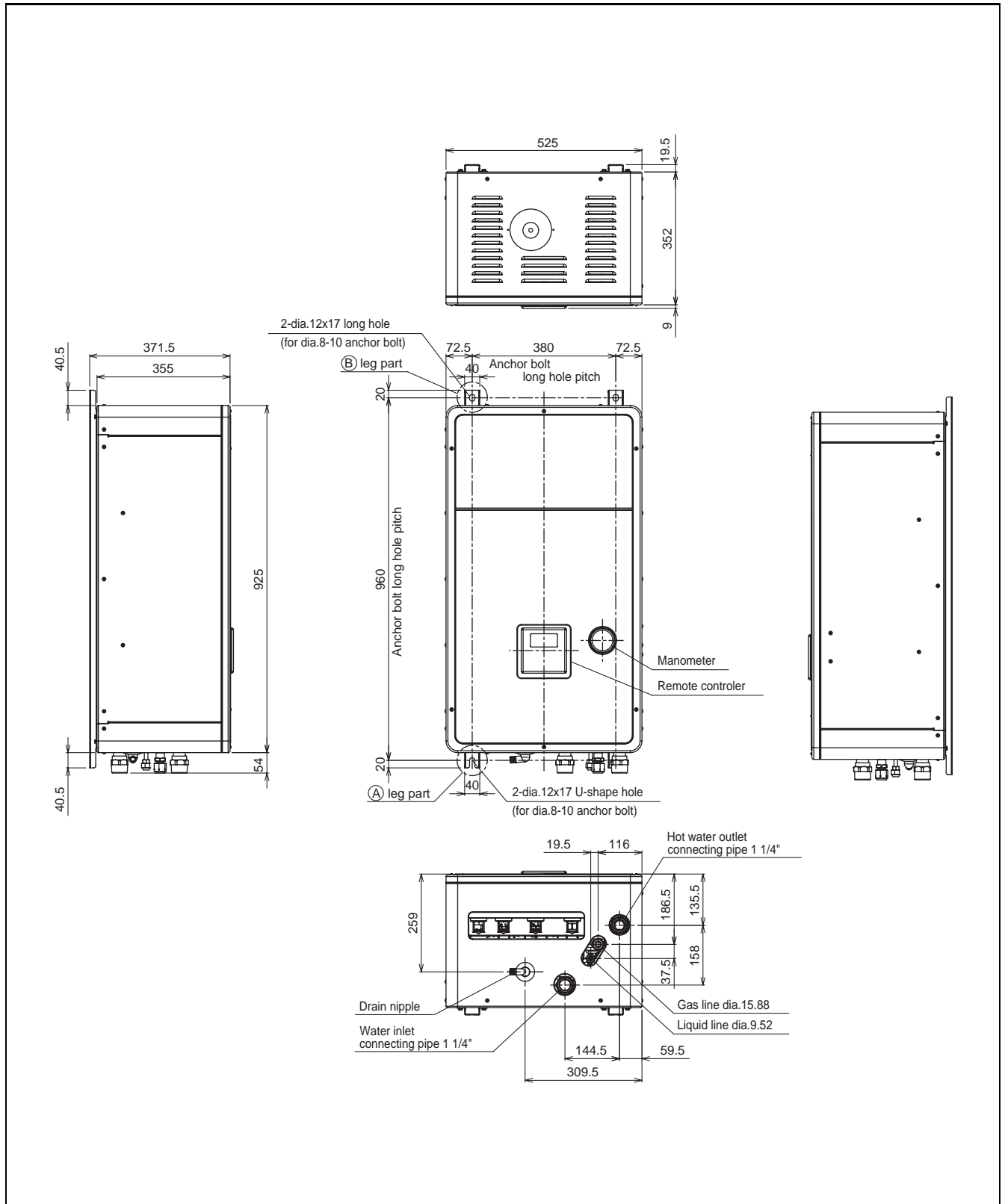

4-2. Outdoor unit

HWS-802H-E

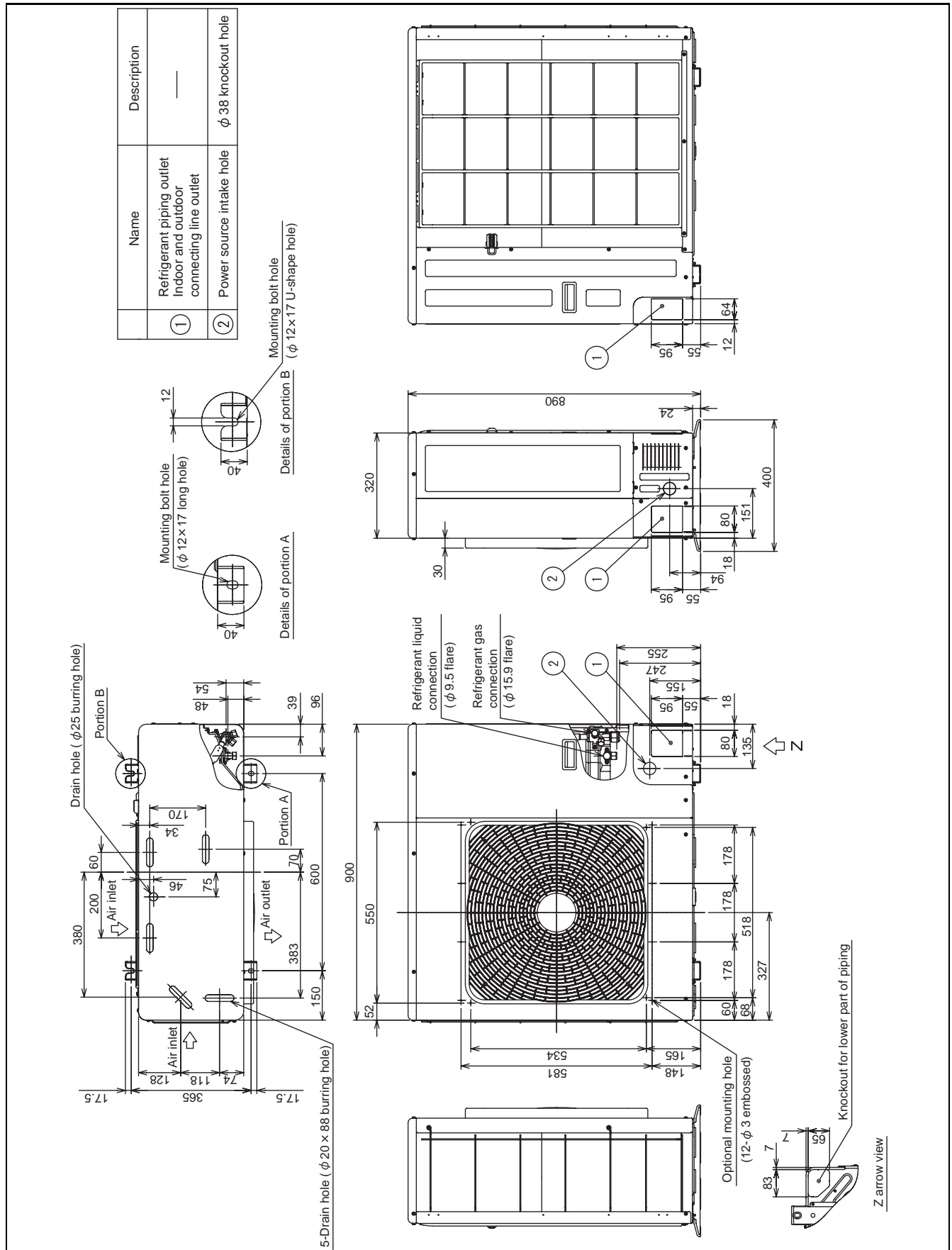

4-3. Hot water cylinder

HWS-3001CSHM3-E(-UK)

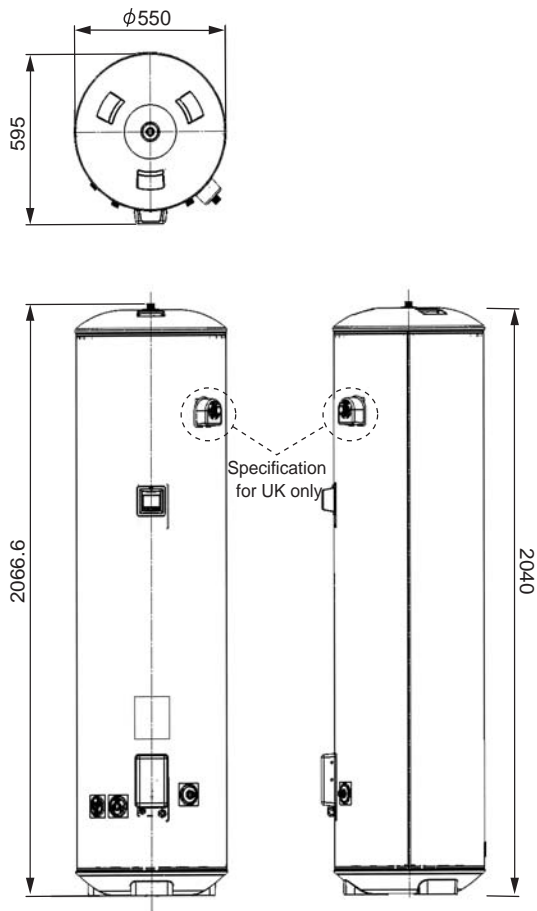

HWS-2101CSHM3-E(-UK)

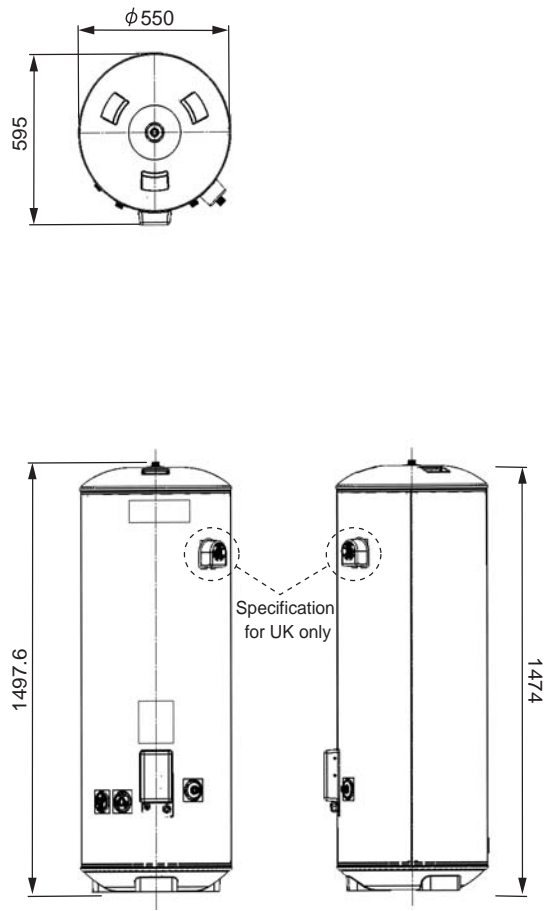

HWS-1501CSHM3-E(-UK)

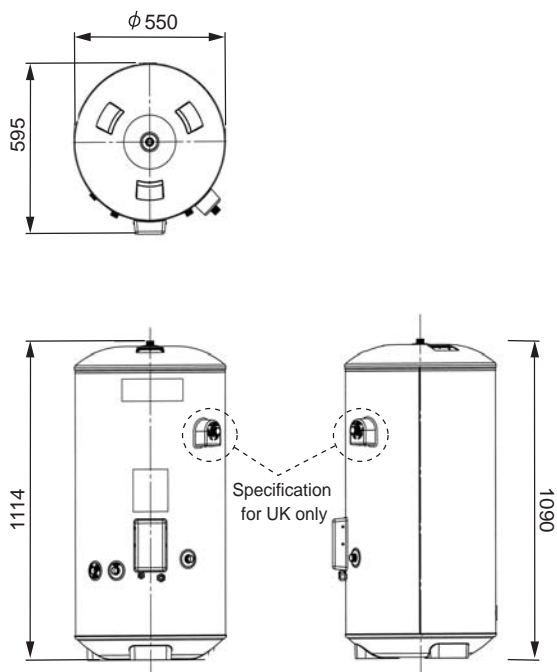

5 Wiring Diagram

5-1. Hydro Unit

WARNING
Perform the grounding from the earth terminal in the terminal block of the outdoor unit.

CAUTION
Electric shock may happen. Don't touch the electric parts.

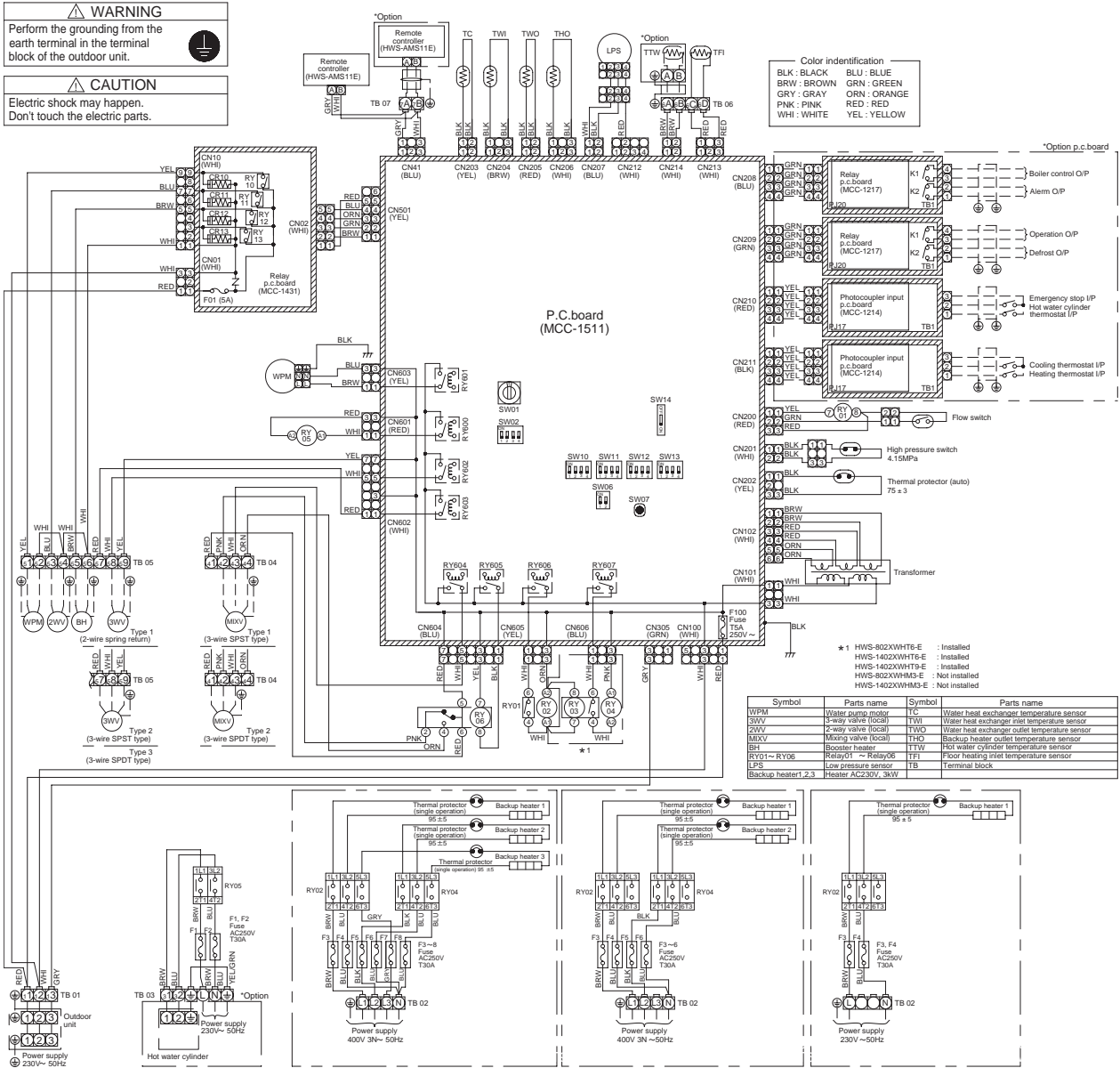

- The one-dot chain line indicates wiring at the local site, and the dashed line indicates accessories sold separately and service wires, respectively.
- and □ indicates the terminal board and the numerals indicate the terminal numbers.
- indicates P.C. board.
* Be sure to fix the electric parts cover surely with screws.
(Otherwise water enters into the box resulting in malfunction.)

5-2. Outdoor Unit

Symbol	Item nam
CM	Compressor
FM	Fan motor
PMV	Pulse motor valve coil
TD	Discharge temperature sensor
TS	Suction temperature sensor
TE	Heat exchange sensor 1
TL	Heat exchange sensor 2
T0	Outdoor temperature sensor
49C	Compressor case thermostat
F01	Fuse 25 A, 250 VAC
F03	Fuse 10A, 250 VAC

1. © indicates a terminal plate. The number inside indicates the terminal number.
2. The double-dashed line indicates a local wiring while the dashed line indicates an optional accessory or service wiring.
3.  indicates a printed board.
4. For the hydro unit circuit, see the hydro unit wiring diagram.

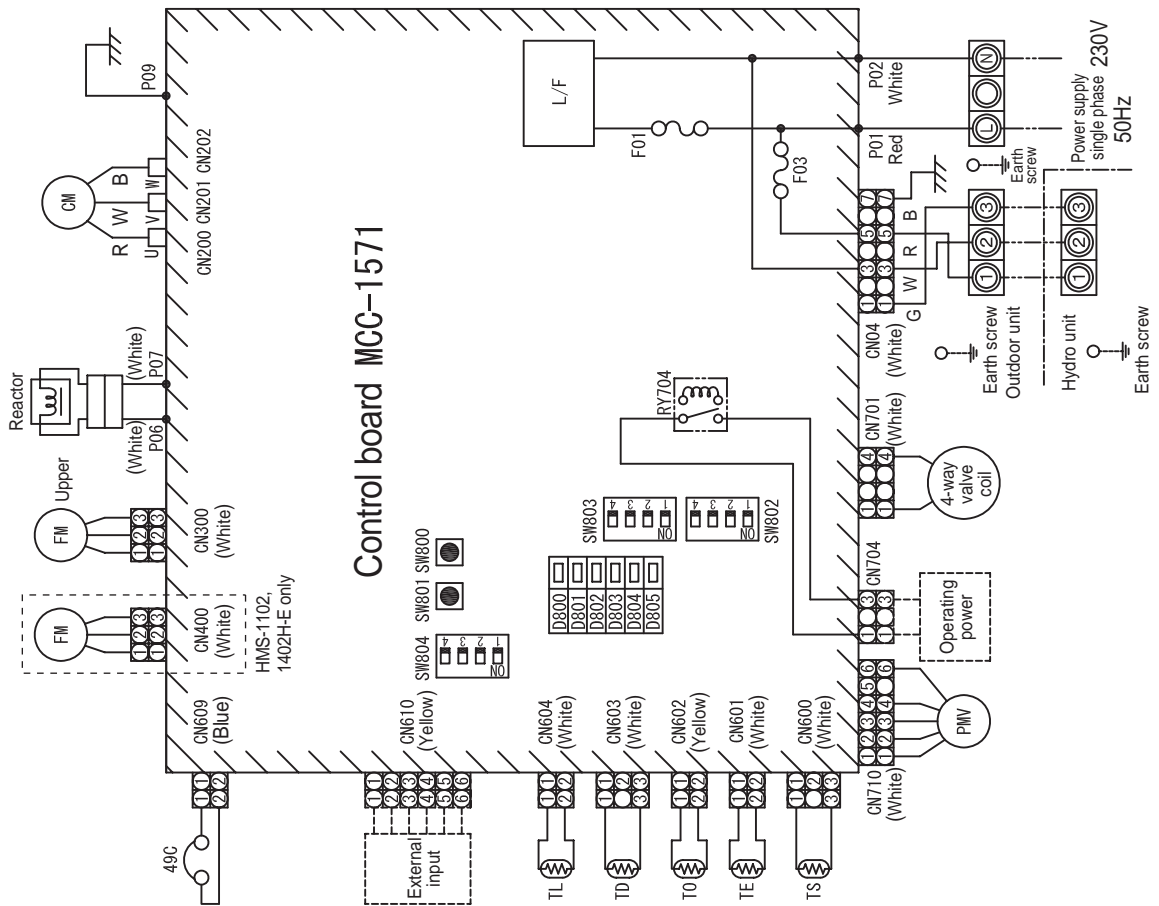

5-3. Hot Water Cylinder Unit

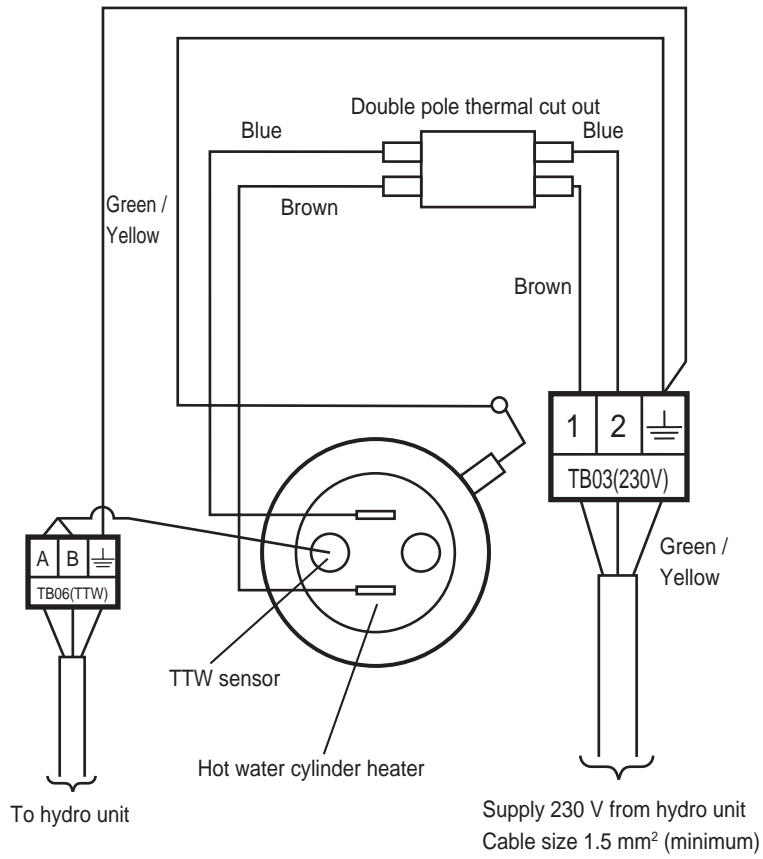

6 Key Electric Component Rating

6-1. Hydro Unit

HWS-802XWHM3-E, 802XWHT6-E

No.	Component name	Model name		Type name	Rating
		M3-E	T6-E		
1	Circulating pump	○	○	UPS025-65 K 130	AC230 V 0.54 A (MAX)
2	Backup heater 6 kW	○	○	–	AC 400 V (3N) 6 kW (AC230 V 3 kW compatible)
3	Backup heater 9 kW			–	AC400V (3N) 9 kW
4	Water heat exchange temperature sensor (TC sensor)	○	○	–	10 kΩ (25°C)
5	Water inlet temperature sensor (TWI sensor)	○	○	–	10 kΩ (25°C)
6	Water outlet temperature sensor (TWO sensor)	○	○	–	10 kΩ (25°C)
7	Heater outlet water temperature sensor (THO sensor)	○	○	–	10 kΩ (25°C)
8	Floor inlet temperature sensor (TFI sensor)	○	○	–	10 kΩ (25°C)
9	Pressure switch	○	○	–	Operating pressure 4.15 MPa +0 -0.3 MPa
10	Low pressure sensor	○	○	–	Operating pressure 0.20 MPa
11	Bimetal thermostat (auto)	○	○	–	Operating temperature 75±3°C DC42 V / 0.2 A
12	Bimetal thermostat (single operation)	○	○	–	Operating temperature 95±5°C AC250 V / 16 A
13	Flow switch	○	○	–	Operating flowing quantity 13 L/min
14	Output board (OP)	OP	OP	TCB-PCIN3E	AC230 V 0.5 A DC24 V 1 A
15	Input board (OP)	OP	OP	TCB-PCM03E	Contact input
16	Remote control	○	○	HWS-AMS11E	
17	Water 3-way valve terminal	○	○	–	AC230 V 0.1 A 2Wire, 3Wire SPST, SPDT type mountable
18	Water 2-way valve terminal	○	○	–	AC230 V 0.1 A 2Wire type mountable
19	Mixing valve terminal	○	○	–	AC230 V 0.1 A 3Wire SPST, SPDT type mountable
20	Circulating pump terminal	○	○	–	AC230 V 1.0 A
21	Booster heater terminal	○	○	–	AC230 V 1.0 A
22	Fuse	○	○	–	AC 250 V 30 A

○ Applied

OP Optional accessory

HWS-1402XWHM3-E, 1402XWHT6-E, 1402XWHT9-E

No.	Component name	Model name			Type name	Rating
		M3-E	T6-E	T9-E		
1	Circulating pump	○	○	○	UPS25-80 130	AC230 V 0.83 A (MAX)
2	Backup heater 6 kW	○	○		–	AC 400 V (3N) 6 kW (AC230 V 3kW compatible)
3	Backup heater 9 kW			○	–	AC 400 V (3N) 9 kW
4	Water heat exchange temperature sensor (TC sensor)	○	○	○	–	10 kΩ (25°C)
5	Water inlet temperature sensor (TWI sensor)	○	○	○	–	10 kΩ (25°C)
6	Water outlet temperature sensor (TWO sensor)	○	○	○	–	10 kΩ (25°C)
7	Heater outlet water temperature sensor (THO sensor)	○	○	○	–	10 kΩ (25°C)
8	Floor inlet temperature sensor (TFI sensor)	○	○	○	–	10 kΩ (25°C)
9	Pressure switch	○	○	○	–	Operating pressure 4.15 MPa +0 -0.3 MPa
10	Low pressure sensor	○	○	○	–	Operating pressure 0.20 MPa
11	Thermal protector (auto)	○	○	○	–	Operating temperature 75±3°C DC42 V / 0.2 A
12	Thermal protector (single operation)	○	○	○	–	Operating temperature 95±5°C AC250 V 16 A
13	Flow switch	○	○	○	–	Operating flowing quantity 18 L/min
14	Output board (OP)	OP	OP	OP	TCB-PCIN3E	AC230 V 0.5 A DC24 V 1 A
15	Input board (OP)	OP	OP	OP	TCB-PCM03E	Contact input
16	Remote control	○	○	○	HWS-AMS11E	
17	Water 3-way valve terminal	○	○	○	–	AC230 V 0.1 A 2Wire, 3Wire SPST, SPDT type mountable
18	Water 2-way valve terminal	○	○	○	–	AC230 V 0.1 A 2Wire type mountable
19	Mixing valve terminal	○	○	○	–	AC230 V 0.1 A 3Wire SPST, SPDT type mountable
20	Circulating pump terminal	○	○	○	–	AC230 V 1.0 A
21	Booster heater terminal	○	○	○	–	AC230 V 1.0 A
22	Fuse	○	○	○	–	AC 250 V 30 A

○ Applied

OP Optional accessory

6-2. Outdoor Unit

HWS-802H-E

No.	Component name	Type name	Rating
1	Compressor	DA220A2F-22L	
2	Outdoor fan motor	ICF-280-A60-1	Output 60 W
3	4-way valve coil	VHV-01AP552B1	AC230 full-wave rectifier input, alive time 10 sec or less
4	Pulse motor valve (PMV) coil	CAM-MD12TF-15	DC12 V
5	Compressor case thermostat	US-622KXTMQO-SS	OFF: 125±4°C ON: 90±5°C
6	Reactor	CH-56	5.8 mH, 18.5 A
7	PC board	MCC-1571	Input 1Ø, AC230 V±23 V, 50/60 Hz

HWS-1102H-E, 1402H-E

No.	Component name	Type name	Rating
1	Compressor	DA422A3F-25M	
2	Outdoor fan motor (x2)	ICF-280-A100-1	Output 100 W
3	Reactor (x2)	CH-44	1.4 mH, 25 A
4	4-way valve coil	UKV-A038	AC230 V full-wave rectifier input, alive time 10 sec or less
5	Pulse motor valve (PMV) coil	VHV-01AP552B1	DC12 V
6	Board	MCC-1560	Input 3Ø, AC230 V±23 V, 50/60 Hz
7	Compressor case thermostat	US-622KXTMQO-SS	OFF = 125 ± 4 °C, ON = 90 ± 5 °C

6-3. Hot Water Cylinder Unit

No.	Component name	Model name			Type name	Rating
		1501 CSH M3-E (-UK)	2101 CSH M3-E (-UK)	3001 CSH M3-E (-UK)		
1	Hot water cylinder heater	<input type="radio"/>	<input type="radio"/>	<input type="radio"/>	–	AC230 V 2.75 KW
2	Hot water cylinder temperature sensor (TTW sensor)	<input type="radio"/>	<input type="radio"/>	<input type="radio"/>	–	10 kΩ (25°C)
3	Thermal cut-out	<input type="radio"/>	<input type="radio"/>	<input type="radio"/>	–	Operating temperature Manual reset 82°C (+3k/-2k)

..... Applied

6-4. Water Heat Exchange Control Board

HWS-802XWHM3-E, 802XWHT6-E
HWS-1402XWHM3-E, 1402XWHT6-E, 1402XWHT9-E

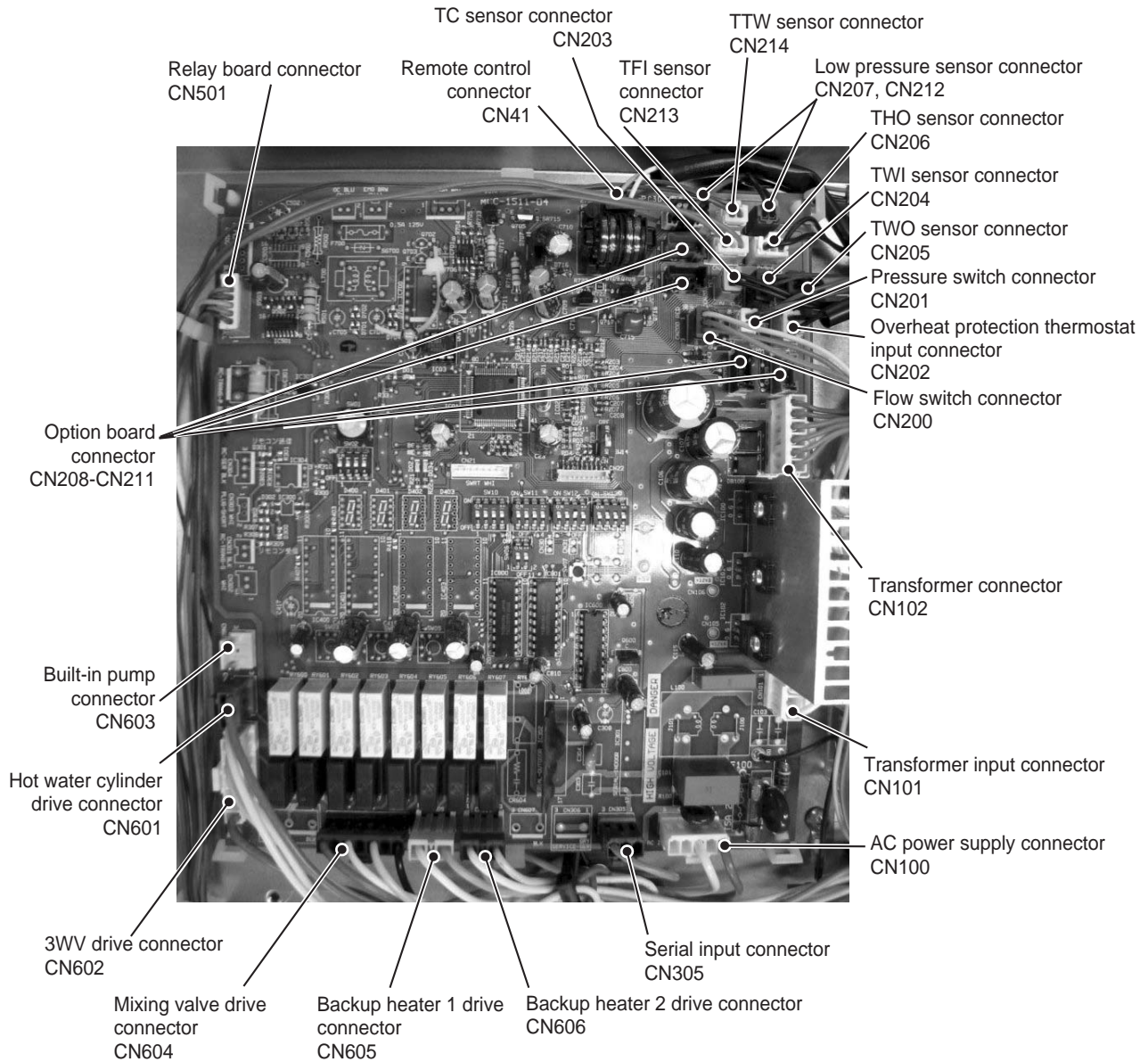

6-5. Outdoor Control Board

HWS-802H-E

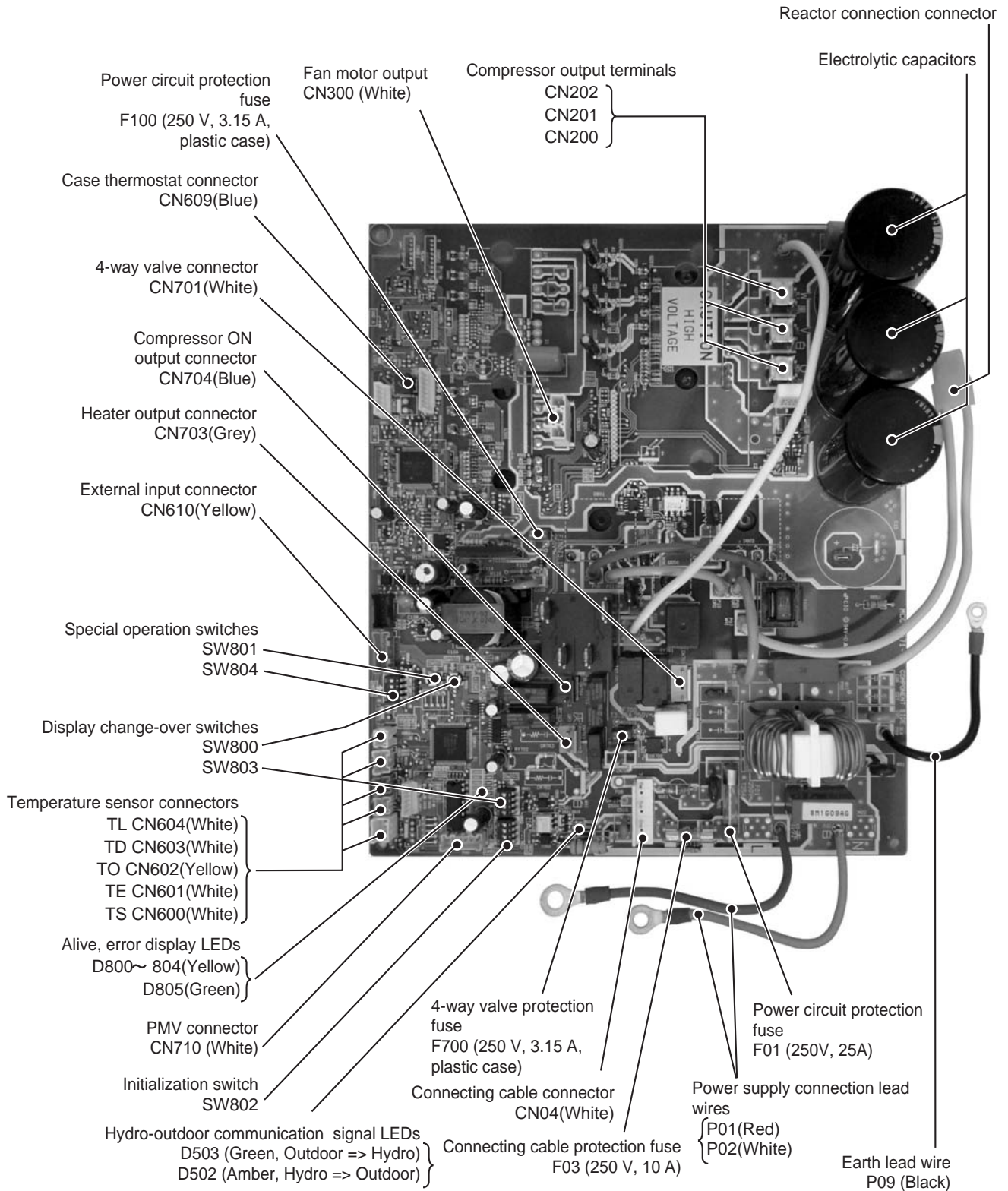

HWS-1102H-E, 1402H-E

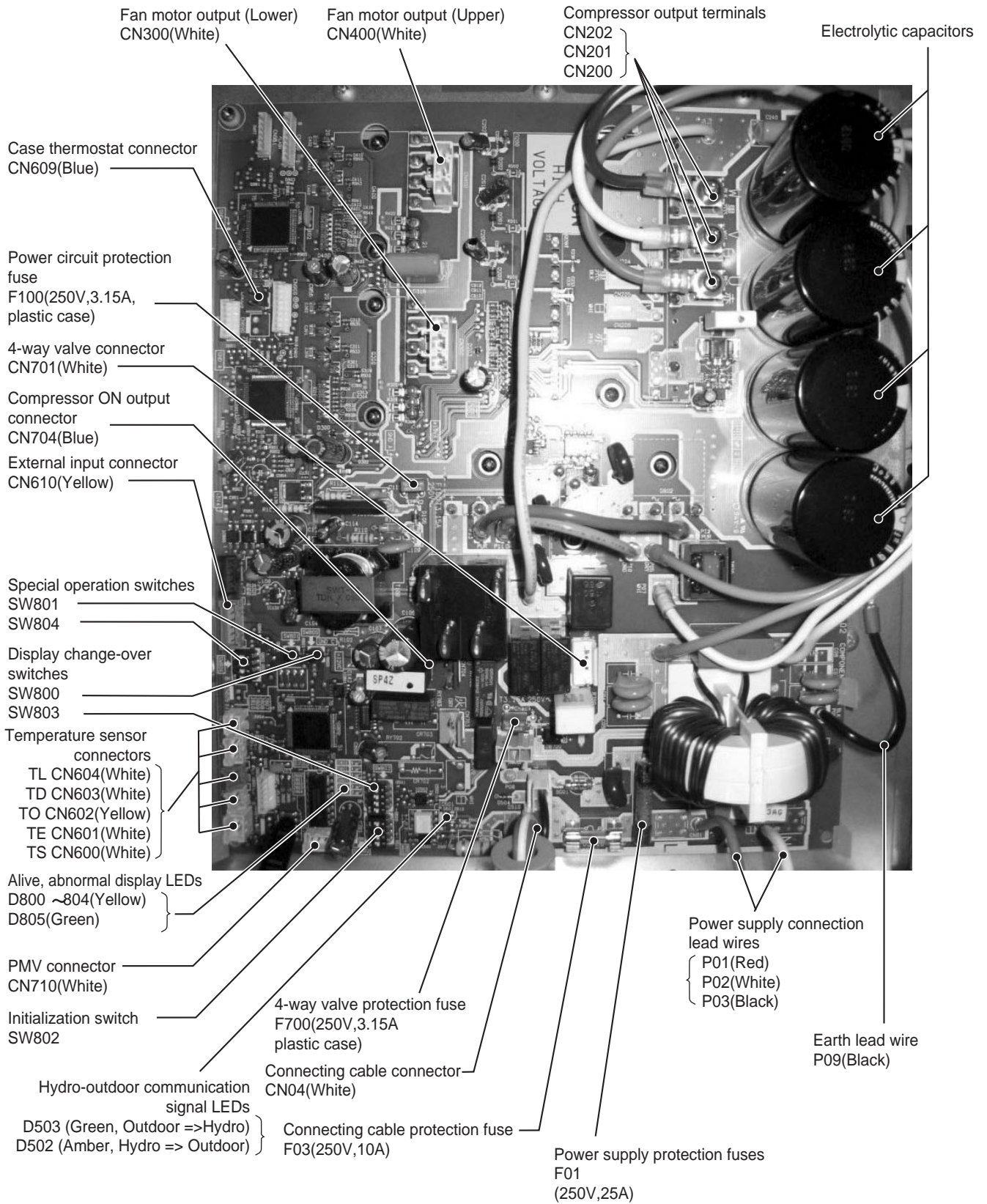

7 Refrigeration Cycle / Water System Diagram

7-1. Water System Diagram

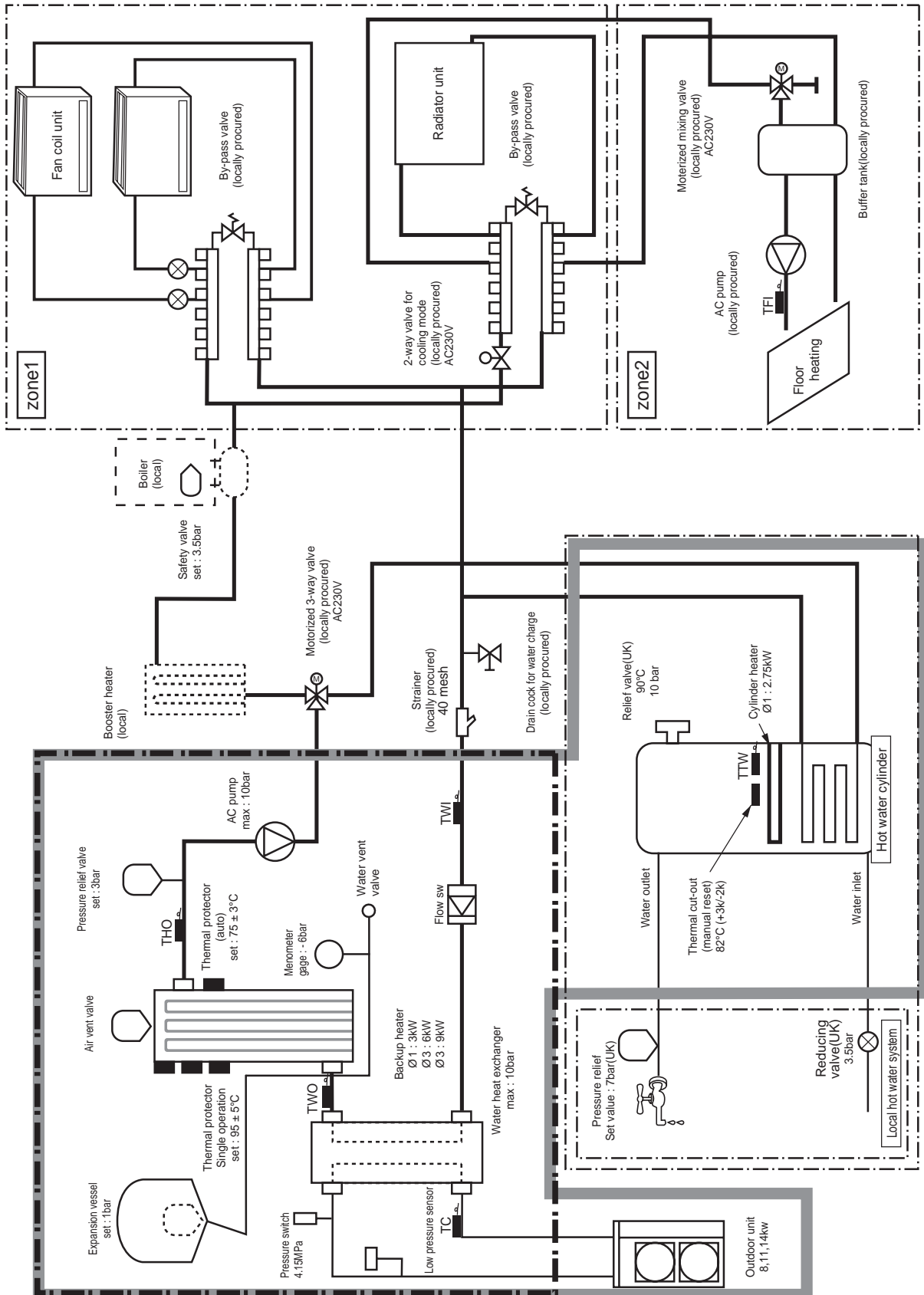

Installation example of water circuit

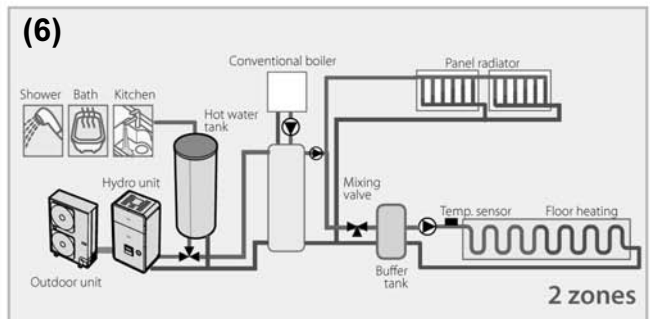
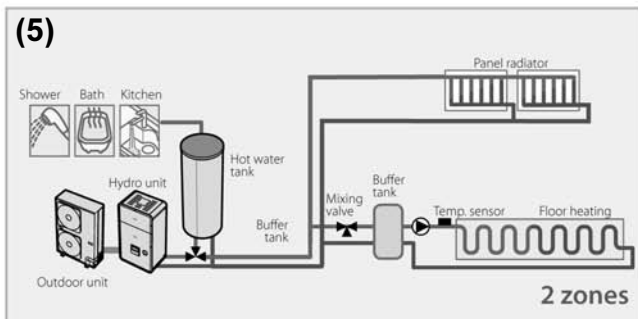
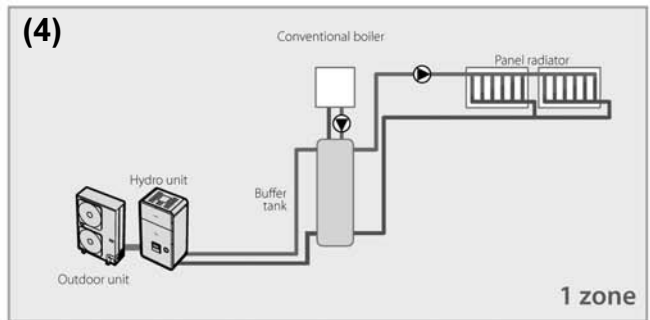
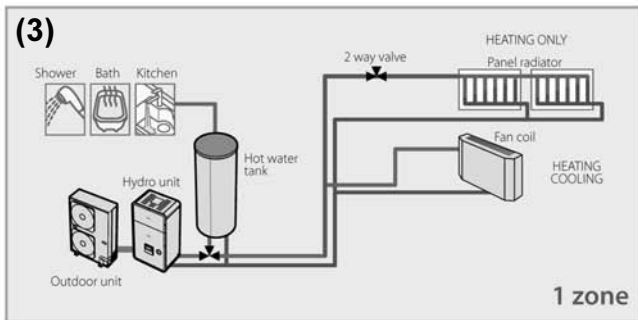
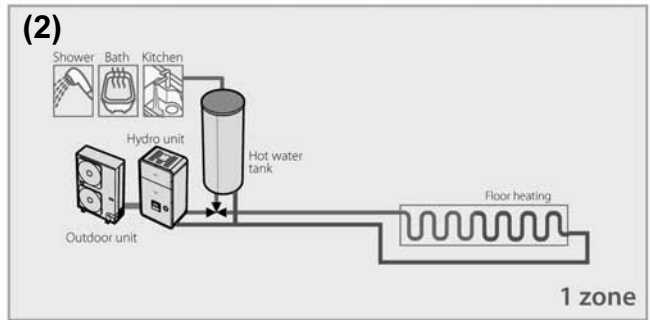
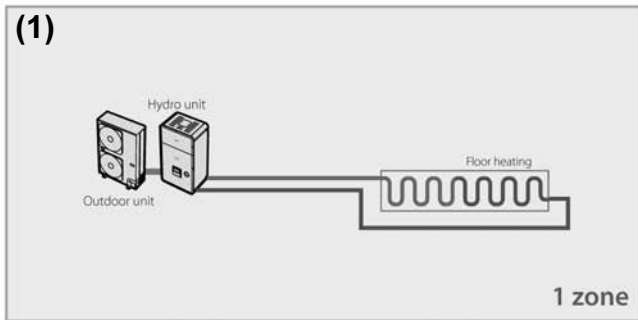

The water circuit for a system without buffer tank ((1), (2), (3), (5)) requires 5 or more branches of Floor heating or Radiator etc.

Less than 5 branches may cause a flow deficiency. In this case, please provide a buffer tank and secondary pumps as shown in (4).

7-2. Refrigeration Cycle System Diagram

HWS-802XWHM3-E, 802XWHT6-E/802H-E

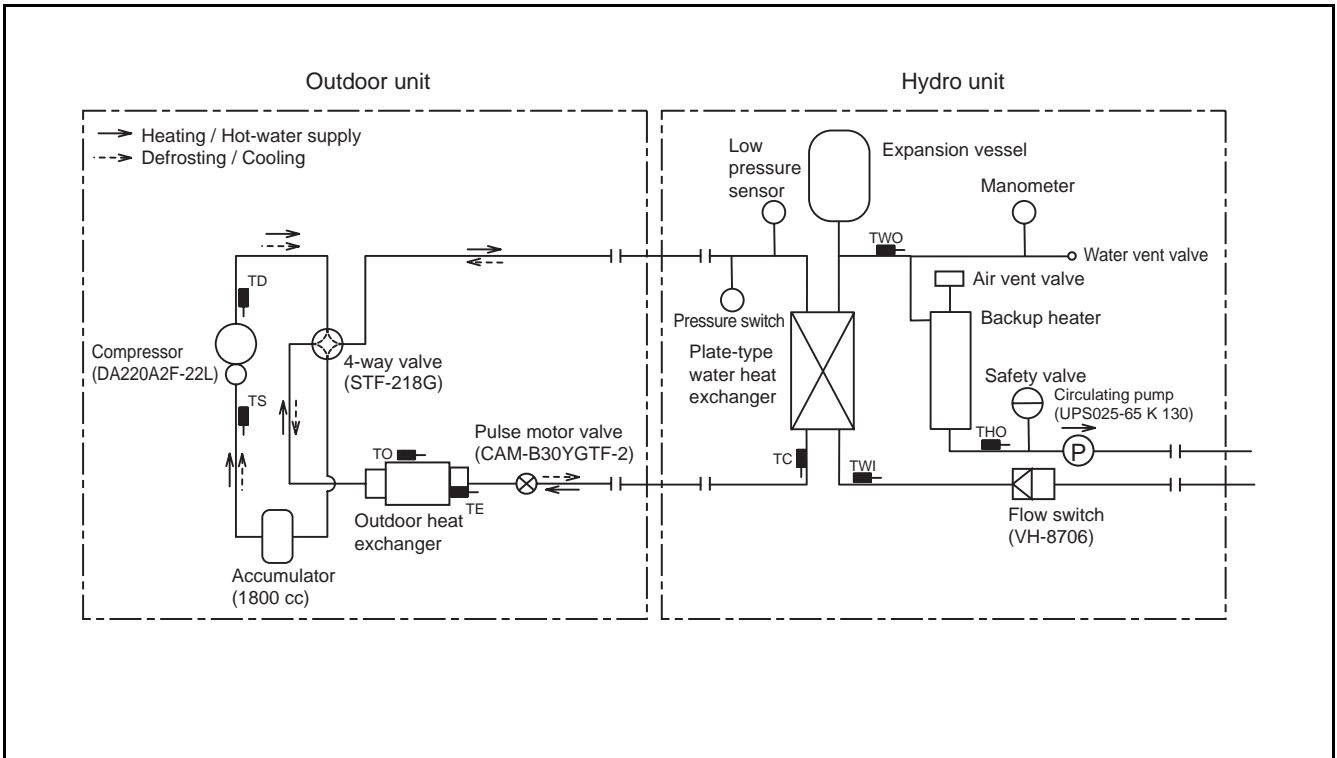

HWS-1402XWHM3-E, 1402XWHT6-E, 1402XWHT9-E/1102H-E, 1402H-E

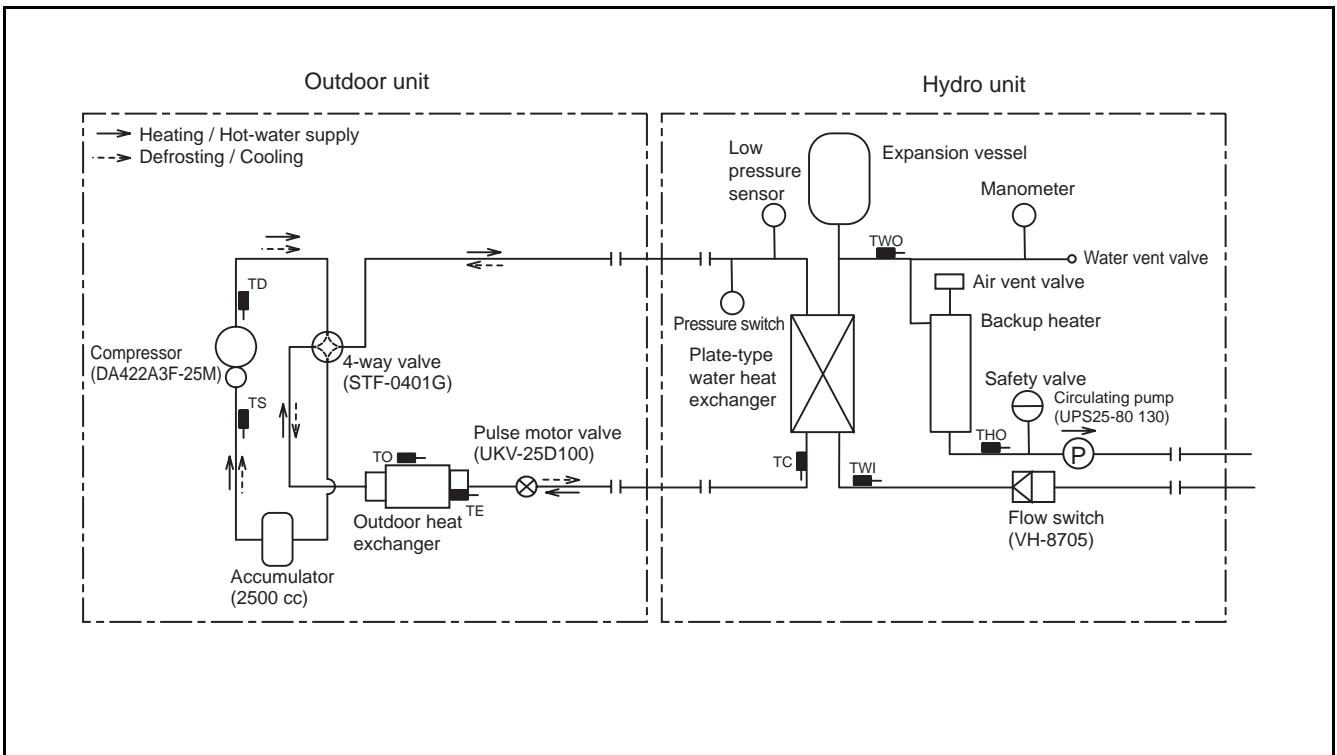

8 Operational Description

This chapter describes the working circuit and control of Air to Water Heat Pump about the following operations.

	Item	Page
8-1	Basic Operation 1) Operation control 2) Hot water supply operation 3) Heating operation 4) Cooling operation	36-38
8-2	Operation Mode and Control Method 1) Hot water supply operation 2) Heating operation 3) Cooling operation 4) Simultaneous operation of "hot water supply" and "heating" 5) Simultaneous operation of "hot water supply" and "cooling" 6) Boiler-assisted heating operation 7) HOT WATER BOOST operation 8) Anti bacteria 9) Night setback operation 10) FROST PROTECTION operation 11) AUTO operation 12) Nighttime low-noise operation	39-47
8-3	Hydro Unit Control 1) Capacity control (compressor, high-temperature release, low-temperature release) 2) Heater control 3) Circulation pump control 4) Flow switch control 5) Mixing valve control (2-temperature heating control) 6) Q-H characteristics of hydro unit 7) Automatic restart control 8) Piping anti-freezing control	48-56
8-4	Outdoor Unit Control 1) PMV (Electronic control valve) control 2) Outlet temperature release control 3) Current release control 4) Current releases shift control 5) Outdoor fan control 6) Defrosting control 7) Winding heating control 8) Continued operation prevention under short-circuit conditions 9) Overcurrent protection control	57-63

Item	Operation flow and applicable data, etc.	Operation description
8-1. Basic Operation	<p>1) Operation control</p> <p>Remote controller</p> <p>AC 230 V for Hot water cylinder heater AC 400 V (3N~) for Back up heater</p> <p>Hydro unit</p> <p>Serial signals transmit and receive</p> <p>Thermostat (Cooling/Heating)</p> <p>Forcible stop input</p> <p>Abnormal stop output</p> <p>Defrosting output</p> <p>Operation output</p> <p>Boiler "ON/OFF"</p> <p>Booster Heater</p> <p>2WV_W</p> <p>3WV_W</p> <p>Hot water supply heater MG</p> <p>Mixing Valve</p> <p>Pressure switch</p> <p>Lo pressure sensor</p> <p>Water heat exchange control board</p> <p>Condensed temperature sensor (TC)</p> <p>Water inlet temperature sensor (TWI)</p> <p>Water outlet temperature sensor (TWO)</p> <p>Water heater outlet temperature sensor (THO)</p> <p>Hot water cylinder (TTW)</p> <p>Floor inlet sensor (TFI)</p> <p>Overheat prevention thermostat</p> <p>Flow switch</p> <p>Hot water cylinder heater</p> <p>Backup heater 1 power-relay</p> <p>Backup heater 2 power-relay</p> <p>AC pump 1 (Built-in pump)</p> <p>Serial signals transmit and receive</p> <p>Outdoor unit</p> <p>Serial communication</p> <p>AC 230 V for heat pump</p> <p>Serial signals transmit and receive</p> <p>Outdoor unit control</p> <ul style="list-style-type: none"> • Inverter frequency control • Waveform synthesis function • Calculation function (Temperature calculation) • AD conversion function • Rapid heating function • Compressor restart • Delay function • G-Tr overcurrent prevention function • Defrosting operation function <p>Inverter</p> <p>Compressor</p> <p>Outdoor fan motor</p> <p>Td sensor</p> <p>Ts sensor</p> <p>Te sensor</p> <p>To sensor</p> <p>PMV</p> <p>4-way valve</p>	<p>1. Purpose</p> <p>The operations of the hydro unit and the outdoor unit are controlled according to user-defined operation condition settings.</p> <p>2. Details</p> <p>The operation controls include those shown in the left.</p> <p>3. Operations</p> <ol style="list-style-type: none"> 1) An operation condition is selected with the remote controller. 2) Setting the remote controller button to "ON" transmits a signal to the hydro unit. 3) The hydro unit controller controls the operations shown in the left while also controlling the water 2-way valve, water 3-way valve, circulation pump, mixing valve, hot water cylinder heater, and backup heater. 4) The hydro unit controller transmits an operation instruction to the outdoor unit, and uses serial signals to transmit and receive control statuses. 5) The outdoor unit control unit performs the operation controls shown in the left while also controlling the compressor, outdoor fan motor, pulse motor valve, and 4-way valve.

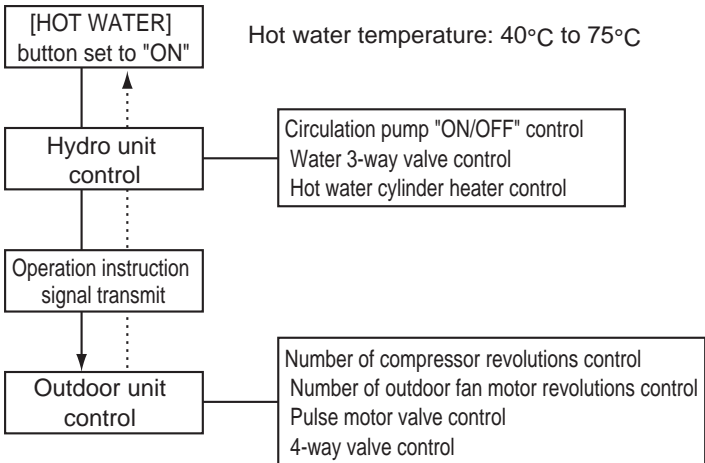
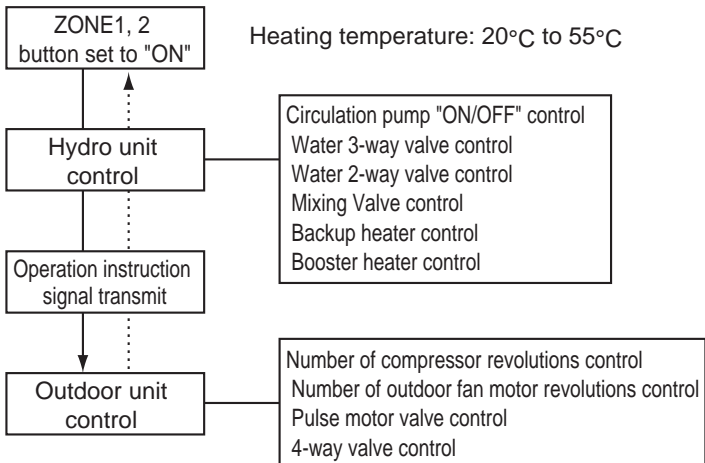
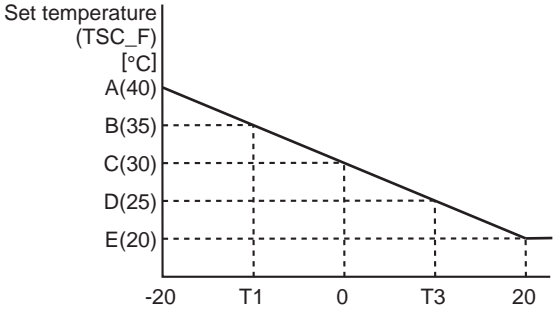
Item	Operation flow and applicable data, etc.	Operation description
8-1. Basic Operation	<p>2) Hot water supply operation</p> <p style="text-align: center;">Hot water temperature: 40°C to 75°C</p> 	<p>Hot water supply operation</p> <ol style="list-style-type: none"> Purpose Hot water supply Details This section performs hot water supply operation according to heating conditions specified for the steps in the left. Operations <ol style="list-style-type: none"> Set the [HOT WATER] remote controller button to "ON". The hydro unit controller starts to transmit a hot water supply operation signal to the outdoor unit control unit. The hydro unit performs the operation controls shown in the left while also controlling the circulation pump, hot water cylinder heater "ON/OFF". The outdoor unit controls the compressor, outdoor fan motor, electric expansion valve, and 4-way valve based on the operation signals transmitted by the hydro unit.
	<p>3) Heating operation</p> <p style="text-align: center;">Heating temperature: 20°C to 55°C</p>   <p>A, B, C, D, E Setting available range 20 to 55°C T1 Setting available range -15 to 0°C T3 Setting available range 0 to +15°C</p>	<p>Heating operation</p> <ol style="list-style-type: none"> Purpose Heating Details This section performs heating operation according to heating conditions specified for the steps in the left. Operations <ol style="list-style-type: none"> Set the [ZONE1, 2] remote controller button to "ON". The hydro unit controller starts to transmit a heating operation signal to the outdoor control unit. The hydro unit performs the operation controls shown in the left while also controlling the circulation pump, backup booster heater "ON/OFF", water 2-way valve, and water 3-way valve. The outdoor unit controls the compressor, outdoor fan motor, electric expansion valve, and 4-way valve based on the operation signals transmitted by the hydro unit.

Item	Operation flow and applicable data, etc.	Operation description								
8-1. Basic Operation	<p>4) Cooling operation</p> <p>Cooling temperature: 10°C to 25°C</p> <p>NOTE: No coding mode in default setting. When use the cooling mode, please change the FC02 to "0".</p> <p>Related FC</p> <table border="1" data-bbox="277 992 1150 1050"> <thead> <tr> <th>FC No.</th> <th>Setting item</th> <th>Default</th> <th>Setting available range</th> </tr> </thead> <tbody> <tr> <td>02</td> <td>Cooling mode availability</td> <td>1: No</td> <td>0: Yes</td> </tr> </tbody> </table>	FC No.	Setting item	Default	Setting available range	02	Cooling mode availability	1: No	0: Yes	<ol style="list-style-type: none"> 1. Purpose Cooling 2. Details This section performs cooling operation according to cooling conditions specified for the steps in the left. 3. Operations <ol style="list-style-type: none"> 1) Set the [ZONE1, 2] remote controller button to "ON". 2) The hydro unit controller starts to transmit a cooling operation signal to the outdoor unit control unit. 3) The hydro unit controller performs the operation controls the shown in the left while also controlling the circulation pump, water 2-way valve, and water 3-way valve. 4) The outdoor unit controls the compressor, outdoor fan motor, pulse motor valve, and 4-way valve based on the operation signals transmitted by the hydro unit.
FC No.	Setting item	Default	Setting available range							
02	Cooling mode availability	1: No	0: Yes							

Item	Operation flow and applicable data, etc.																																						
8-2. Operation Mode and Control Method	The following shows the operation modes and controlled objects.																																						
	Operation mode Controlled object	Cooling only	Heating only	Hot water supply only	Heating and Hot water				Cooling and Hot water																														
					Heat pump select for heating		Heat pump select for hot water supply		Heat pump select for cooling		Heat pump select for hot water supply																												
					Heating side	Hot water supply side	Heating side	Hot water supply side	Cooling side	Hot water supply side	Cooling side	Hot water supply side																											
	Heat pump	○	○	○	○	×	×	○	○	×	×	○																											
	Backup heater	×	○	×	○	×	×	×	×	×	×	×																											
	Hot water cylinder heater	×	×	○	×	○	×	○	×	○	×	○																											
	○ Possible × Not possible																																						
	<p>1) Hot water supply operation</p> <p>1) Operation start condition When the [HOT WATER] remote controller button is pressed and the following operation start condition is met, the operation starts.</p> <ul style="list-style-type: none"> • TTW < 38°C is detected. <p>2) Operation mode determination An operation mode is determined according to the temperature of TTW sensor.</p> <ul style="list-style-type: none"> • Heat pump operation selection *1 *2 • When TTW < 38°C (a zone in the right figure) is met, the heat pump operation is selected. • Heater operation selection When 45°C ≤ TTW < TSC_H (b zone in the right figure) is met, the heater operation is selected. • Thermostat status "OFF" selection When TTW ≥ TSC_H is met, the thermostat status "OFF" is selected. <p>3) Operation stop The operation stops in the following cases.</p> <ul style="list-style-type: none"> • The remote controller gives a stop instruction. • TTW ≥ TSC_H is met. <p>*1: When the outside temperature is -20°C or below, the heater operation is selected even if the TTW temperature falls into "a zone".</p> <p>*2: When "Hot water supply" and "Heating" are simultaneously in operation, the heater operation may be selected depending on the outside air temperature.</p>																																						
	Related FC																																						
<table border="1" style="width: 100%; border-collapse: collapse;"> <thead> <tr> <th style="width: 10%;">FC No.</th> <th style="width: 50%;">Setting item</th> <th style="width: 15%;">Default</th> <th style="width: 25%;">Setting available range</th> </tr> </thead> <tbody> <tr> <td>1E</td> <td>Upper limit of hot water supply temperature</td> <td>75°C</td> <td>60-80°C</td> </tr> <tr> <td>1F</td> <td>Lower limit of hot water supply temperature</td> <td>40°C</td> <td>40-60°C</td> </tr> <tr> <td>20</td> <td>Heat pump start temperature</td> <td>38°C</td> <td>20-45°C</td> </tr> <tr> <td>21</td> <td>Heat pump end temperature</td> <td>45°C</td> <td>40-50°C</td> </tr> <tr> <td>24</td> <td>Outside air correction start temperature for hot water supply*3</td> <td>0°C</td> <td>-20-10°C</td> </tr> <tr> <td>25</td> <td>Outside air correction temperature for hot water supply*3</td> <td>3 deg</td> <td>0 -15 deg</td> </tr> </tbody> </table>												FC No.	Setting item	Default	Setting available range	1E	Upper limit of hot water supply temperature	75°C	60-80°C	1F	Lower limit of hot water supply temperature	40°C	40-60°C	20	Heat pump start temperature	38°C	20-45°C	21	Heat pump end temperature	45°C	40-50°C	24	Outside air correction start temperature for hot water supply*3	0°C	-20-10°C	25	Outside air correction temperature for hot water supply*3	3 deg	0 -15 deg
FC No.	Setting item	Default	Setting available range																																				
1E	Upper limit of hot water supply temperature	75°C	60-80°C																																				
1F	Lower limit of hot water supply temperature	40°C	40-60°C																																				
20	Heat pump start temperature	38°C	20-45°C																																				
21	Heat pump end temperature	45°C	40-50°C																																				
24	Outside air correction start temperature for hot water supply*3	0°C	-20-10°C																																				
25	Outside air correction temperature for hot water supply*3	3 deg	0 -15 deg																																				
<p>*3: When the outside temperature is 0°C or below, the boil-up temperature will be higher that setting temperature in hot water supply mode.</p>																																							

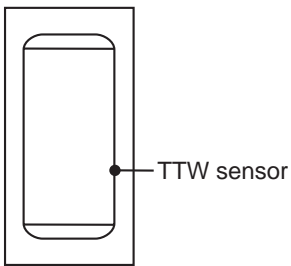

(Hot water cylinder unit)

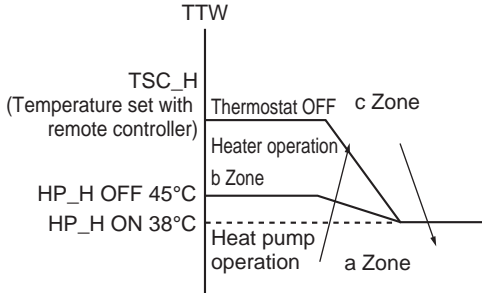

TSC_H is hot water temperature set with remote controller

Item	Operation flow and applicable data, etc.																				
8-2. Operation Mode and Control Method	<p>2) Heating operation</p> <p><Operation only for ZONE1></p> <ul style="list-style-type: none"> This operation is enabled when DP_SW12_2 ZONE1 is set to "ON" (default). The remote controller displays <input type="text" value="ZONE1"/> settings, and only the set temperature of <input type="text" value="ZONE1"/> can be changed. <p><Operation for ZONE1 and ZONE2 (2 temperatures control)></p> <ul style="list-style-type: none"> This operation is enabled when DP_SW12_2 ZONE1 is set to "ON" (default) and DP_SW12_3 ZONE2 to "ON". The remote controller displays <input type="text" value="ZONE1"/> <input type="text" value="ZONE2"/> settings, and the set temperatures of <input type="text" value="ZONE1"/> <input type="text" value="ZONE2"/> can be changed. To set temperatures for <input type="text" value="ZONE1"/> and <input type="text" value="ZONE2"/>, use SELECT <input type="button" value="◀"/> <input type="button" value="▶"/> to switch <input type="text" value="ZONE1"/> and <input type="text" value="ZONE2"/>. For 2 temperatures control, the flow adjustment of MIXING VALVE controls the water temperature of <input type="text" value="ZONE2"/>. For details, see the description on MIXING VALVE control in 8-3-5. <p>1) Operation start condition</p> <p>Pressing the [ZONE1, 2] button of remote controller starts a heating operation. *1 *2</p> <p>2) Operation mode selection</p> <p>An operation mode is determined according to the temperature of TWI sensor.</p> <ul style="list-style-type: none"> Heat pump operation selection *1 *2 When $TWI < TSC_F$ (d zone in the right figure) is met, the heat pump operation is selected. Thermostat status "OFF" When $TWI \geq TSC_F$ (e zone in the right figure) is met, the thermostat status "OFF" is selected. <p>3) Operation stop condition</p> <p>When the following condition is met, the heating operation stops.</p> <ul style="list-style-type: none"> The remote controller gives a stop instruction. <p>*1: When the outside temperature is -20°C or below, the heater operation is selected even if the TTW temperature falls into "d zone".</p> <p>*2: When "Hot water supply" and "Heating" are simultaneously in operation, the heater operation may be selected depending on the outside air temperature.</p> <p>Related FC</p> <table border="1" data-bbox="328 1335 1318 1480"> <thead> <tr> <th>FC No.</th> <th>Setting item</th> <th>Default</th> <th>Setting available range</th> </tr> </thead> <tbody> <tr> <td>1A</td> <td>Upper limit of heating (Zone1) limited temperature</td> <td>55</td> <td>37-55°C</td> </tr> <tr> <td>1B</td> <td>Lower limit of heating (Zone1) limited temperature</td> <td>20</td> <td>20-37°C</td> </tr> <tr> <td>1C</td> <td>Upper limit of heating (Zone2) limited temperature</td> <td>55</td> <td>37-55°C</td> </tr> <tr> <td>1D</td> <td>Lower limit of heating (Zone2) limited temperature</td> <td>20</td> <td>20-37°C</td> </tr> </tbody> </table>	FC No.	Setting item	Default	Setting available range	1A	Upper limit of heating (Zone1) limited temperature	55	37-55°C	1B	Lower limit of heating (Zone1) limited temperature	20	20-37°C	1C	Upper limit of heating (Zone2) limited temperature	55	37-55°C	1D	Lower limit of heating (Zone2) limited temperature	20	20-37°C
FC No.	Setting item	Default	Setting available range																		
1A	Upper limit of heating (Zone1) limited temperature	55	37-55°C																		
1B	Lower limit of heating (Zone1) limited temperature	20	20-37°C																		
1C	Upper limit of heating (Zone2) limited temperature	55	37-55°C																		
1D	Lower limit of heating (Zone2) limited temperature	20	20-37°C																		

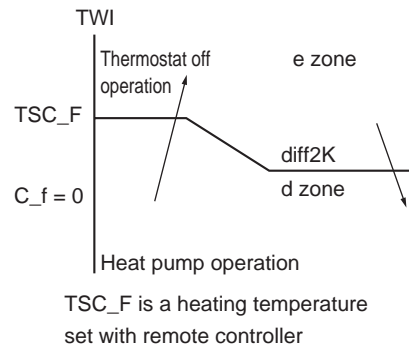

Item	Operation flow and applicable data, etc.																														
8-2. Operation Mode and Control Method	<p>3) Cooling operation Pressing the [ZONE1, 2] button and then [OPERATION MODE] starts a cooling operation.</p> <p>1) Operation start condition Pressing the [ZONE1, 2] button and then [OPERATION MODE] starts a cooling operation.</p> <p>2) Operation mode selection An operation mode is determined according to the temperature of TWI sensor.</p> <ul style="list-style-type: none"> Heat pump operation selection *1 *2 When $TWI \geq TSC_F$ (d zone in the right figure) is met, the heat pump operation is selected. Thermostat status "OFF" When $TWI < TSC_F$ (e zone in the right figure) is met, the thermostat status "OFF" is selected. <p>3) Operation stop condition When either of the following conditions is met, the cooling operation stops.</p> <ul style="list-style-type: none"> The remote controller gives a stop instruction. The operation is switched to heating. <p>*1: When the outside temperature is 10°C or below, cooling does not start even if the TWI temperature falls into "d zone".</p> <p>Related FC</p> <table border="1" data-bbox="328 972 1318 1088"> <thead> <tr> <th>FC No.</th> <th>Setting item</th> <th>Default</th> <th>Setting available range</th> </tr> </thead> <tbody> <tr> <td>02</td> <td>Cooling mode availability</td> <td>1: No</td> <td>0: Yes</td> </tr> <tr> <td>18</td> <td>Upper limit of cooling setting temperature</td> <td>25</td> <td>18-30°C</td> </tr> <tr> <td>19</td> <td>Lower limit of cooling setting temperature</td> <td>10</td> <td>10-18°C</td> </tr> </tbody> </table>	FC No.	Setting item	Default	Setting available range	02	Cooling mode availability	1: No	0: Yes	18	Upper limit of cooling setting temperature	25	18-30°C	19	Lower limit of cooling setting temperature	10	10-18°C														
FC No.	Setting item	Default	Setting available range																												
02	Cooling mode availability	1: No	0: Yes																												
18	Upper limit of cooling setting temperature	25	18-30°C																												
19	Lower limit of cooling setting temperature	10	10-18°C																												
	<p>4) Simultaneous operations of "hot water supply" and "heating" At the time of "Hot water supply" and "Heating" simultaneous operation, the operation mode is select as follows depending on the outside air temperature.</p> <ul style="list-style-type: none"> f zone Operation with hot water supply priority A heat pump operation is performed in the hot water supply side, and a heating operation in the heating side. g zone Operation with heating priority A heat pump operation is performed in the heating side, and a heating operation in the hot water supply side. <p>Operation mode by zone</p> <table border="1" data-bbox="328 1456 938 1572"> <thead> <tr> <th>Zone</th> <th>Hot water supply side</th> <th>Heating side</th> </tr> </thead> <tbody> <tr> <td>f</td> <td>Heat pump *</td> <td>Stop *</td> </tr> <tr> <td>g</td> <td>Heater</td> <td>Heat pump</td> </tr> <tr> <td>h</td> <td>Heater</td> <td>Heater</td> </tr> </tbody> </table> <p>* Note that after a heat pump operation for "Hot water supply" is selected in f zone, when the operation moves to a heater operation for "hot water" and then 5 minutes has passed (Hot water supply operation in b zone), the operation mode changes as follows.</p> <table border="1" data-bbox="328 1706 938 1765"> <thead> <tr> <th>Zone</th> <th>Hot water supply side</th> <th>Heating side</th> </tr> </thead> <tbody> <tr> <td>f'</td> <td>Heater</td> <td>Heat pump</td> </tr> </tbody> </table> <p>When $TTW \geq 45^\circ\text{C}$ (FC: changeable) is met, the operation ends f' zone and returns to f zone.</p> <p>Related FC</p> <table border="1" data-bbox="328 1859 1318 1966"> <thead> <tr> <th>FC No.</th> <th>Setting item</th> <th>Default</th> <th>Setting available range</th> </tr> </thead> <tbody> <tr> <td>07</td> <td>Maximum HP operation time in "hot water supply" + "heating mode"</td> <td>30 min</td> <td>0-120min</td> </tr> <tr> <td>22</td> <td>Priority mode switch temperature (D)</td> <td>0</td> <td>-20-20°C</td> </tr> </tbody> </table> <p>* Note: When user selects "hot water supply" and "ZONE1,2", and Heat pump selects hot water supply mode, the Maximum operating time of heat pump is 30 mins.</p>	Zone	Hot water supply side	Heating side	f	Heat pump *	Stop *	g	Heater	Heat pump	h	Heater	Heater	Zone	Hot water supply side	Heating side	f'	Heater	Heat pump	FC No.	Setting item	Default	Setting available range	07	Maximum HP operation time in "hot water supply" + "heating mode"	30 min	0-120min	22	Priority mode switch temperature (D)	0	-20-20°C
Zone	Hot water supply side	Heating side																													
f	Heat pump *	Stop *																													
g	Heater	Heat pump																													
h	Heater	Heater																													
Zone	Hot water supply side	Heating side																													
f'	Heater	Heat pump																													
FC No.	Setting item	Default	Setting available range																												
07	Maximum HP operation time in "hot water supply" + "heating mode"	30 min	0-120min																												
22	Priority mode switch temperature (D)	0	-20-20°C																												

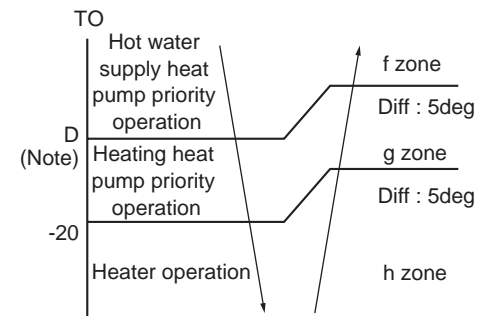
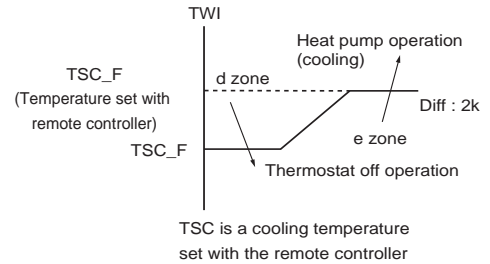

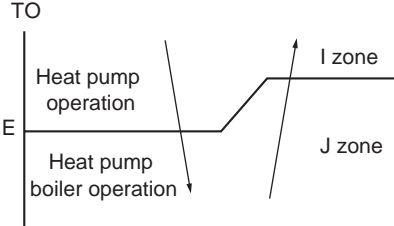
Item	Operation flow and applicable data, etc.																								
8-2. Operation Mode and Control Method	<p>5) Simultaneous operations of "hot water supply" and "cooling"</p> <p>For simultaneous operations of "hot water supply" and "cooling", basically cooling runs by a heat pump operation, and hot water supply by a heater operation.</p> <table border="1" data-bbox="328 383 938 443"> <thead> <tr> <th></th> <th>Hot water supply side</th> <th>Cooling side</th> </tr> </thead> <tbody> <tr> <td>Normal</td> <td>Heater *</td> <td>Heat pump *</td> </tr> </tbody> </table> <p>* Note that after a "cooling" heat pump operation is selected, if the thermostat off status continues for 10 minutes and TTW < 38°C is met, the operation switches to a hot water supply operation.</p> <table border="1" data-bbox="328 533 938 633"> <thead> <tr> <th></th> <th>Hot water supply side</th> <th>Cooling side</th> </tr> </thead> <tbody> <tr> <td>Cooling thermostat off 10 min. passed</td> <td>Heat pump</td> <td>Stop</td> </tr> </tbody> </table> <p>When TTW ≥ 45°C (FC: changeable) is met, the operation returns to the normal mode.</p> <p>6) Boiler-assisted heating operation</p> <p>This operation is enabled when DPSW13_2 is ON (A boiler exists).</p> <ul style="list-style-type: none"> I zone Heat pump operation A heat pump operation is usually performed. J zone Heat pump operation + Boiler operation *1 A heat pump + boiler operations (*2) are performed, and a heater operation is performed in the Hot water supply side.  <p>*1: In J zone, the hydro unit setting has a priority, and when the set temperature is reached, the boiler output also becomes OFF. Setting FC_3E to "1" makes the boiler has a priority, and even if the hydro unit set temperature is reached, the boiler output remains "ON".</p> <p>*2: The boiler operation only gives boiler instruction from the hydro unit through the option board.</p> <p>Related FC</p> <table border="1" data-bbox="328 1285 1318 1440"> <thead> <tr> <th>FC No.</th> <th>Setting item</th> <th>Default</th> <th>Setting available range</th> </tr> </thead> <tbody> <tr> <td>23</td> <td>Heat pump only / Simultaneous operation switching TO temperature (E)</td> <td>-10</td> <td>-20-20°C</td> </tr> <tr> <td>3E</td> <td>Hydro unit setting / Boiler set temperature priority switching</td> <td>0: Priority on hydro unit setting</td> <td>1: Priority on boiler setting</td> </tr> </tbody> </table>		Hot water supply side	Cooling side	Normal	Heater *	Heat pump *		Hot water supply side	Cooling side	Cooling thermostat off 10 min. passed	Heat pump	Stop	FC No.	Setting item	Default	Setting available range	23	Heat pump only / Simultaneous operation switching TO temperature (E)	-10	-20-20°C	3E	Hydro unit setting / Boiler set temperature priority switching	0: Priority on hydro unit setting	1: Priority on boiler setting
	Hot water supply side	Cooling side																							
Normal	Heater *	Heat pump *																							
	Hot water supply side	Cooling side																							
Cooling thermostat off 10 min. passed	Heat pump	Stop																							
FC No.	Setting item	Default	Setting available range																						
23	Heat pump only / Simultaneous operation switching TO temperature (E)	-10	-20-20°C																						
3E	Hydro unit setting / Boiler set temperature priority switching	0: Priority on hydro unit setting	1: Priority on boiler setting																						

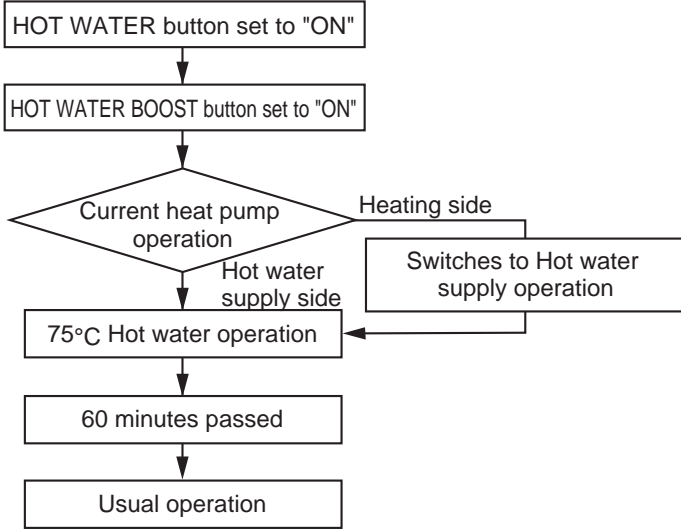
Item	Operation flow and applicable data, etc.												
8-2. Operation Mode and Control Method	<p>7) Hot water boost operation A hot water boost operation boils water quickly to the set temperature TSC_H = 75°C (FC_09).</p> <p>1) How to operate</p> <ul style="list-style-type: none"> When pressing the [HOT WATER BOOST] button after pressing the remote controller [HOT WATER] button, a heat pump operation in progress in the heating side switches to in the hot water side, and continues the operation regardless of the hot water supply start condition, TTW < 38°C. In addition, the hot water cylinder is immediately energized to start a Hot water supply operation under TSC_H = 75°C. A hot water boost operation returns to the usual operation after 60 minutes. The remote controller display during a hot water boost operation is the same as the set temperature display of a usual Hot water supply operation. The usual set temperature change is used for changing the set temperature during a hot water boost operation. Change the BOOST set temperature with FC_09, if necessary.  <pre> graph TD A[HOT WATER button set to "ON"] --> B[HOT WATER BOOST button set to "ON"] B --> C{Current heat pump operation} C -- Heating side --> D[Switches to Hot water supply operation] C -- Hot water supply side --> E[75°C Hot water operation] D --> E E --> F[60 minutes passed] F --> G[Usual operation] </pre> <p>Related FC</p> <table border="1" data-bbox="328 1245 1318 1357"> <thead> <tr> <th>FC No.</th> <th>Setting item</th> <th>Default</th> <th>Setting available range</th> </tr> </thead> <tbody> <tr> <td>09</td> <td>HOT WATER BOOST set temperature</td> <td>75°C</td> <td>40-80°C</td> </tr> <tr> <td>08</td> <td>HOT WATER BOOST operation time</td> <td>60 mins</td> <td>30-180 mins Every 10 mins</td> </tr> </tbody> </table>	FC No.	Setting item	Default	Setting available range	09	HOT WATER BOOST set temperature	75°C	40-80°C	08	HOT WATER BOOST operation time	60 mins	30-180 mins Every 10 mins
FC No.	Setting item	Default	Setting available range										
09	HOT WATER BOOST set temperature	75°C	40-80°C										
08	HOT WATER BOOST operation time	60 mins	30-180 mins Every 10 mins										

Item	Operation flow and applicable data, etc.																				
8-2. Operation Mode and Control Method	<p>8) Anti bacteria (ANTI BACTERIA) operation An anti bacteria operation regularly performs a Hot water supply operation with the set temperature TSC_H = 75°C (can be set with FC_0A).</p> <p>1) How to operate</p> <ul style="list-style-type: none"> Pressing the [HOT WATER] button and then the remote controller [ANTI BACTERIA] button changes the setting to TSC_H = 75°C at the set cycle and time (both can be set with the remote controller FC) to start ANTI BACTERIA operation. The first anti bacteria operation starts when press the [ANTI BACTERIA] button and starting time come. When the set temperature 75°C is reached after the ANTI BACTERIA operation started, the set temperature remains another 30 minutes (can be set with FC_0B). The priority zone determined by the outside temperature selects an operation, Hot water heat pump or hot water supply heater. The hot water heat pump operation, when selected, ignores the hot water supply start condition (TTW < 38°C) and forcibly performs a hot water operation. During ANTI BACTERIA operation (Forcible hot water operation at 75°C), the hot water set temperature display is not changed. If it is changed from the remote controller, the normal hot water set temperature will be changed. <div style="text-align: center;"> <pre> graph TD A[HOT WATER button set to "ON"] --> B[ANTI BACTERIA button set to "ON"] B --> C[Anti bacteria start time] C --> D[75°C hot water supply operation] D --> E[75°C hot water supply operation for 30 minutes] E --> F[Usual hot water supply operation (Set temperature: 40°C to 75°C)] F --> C </pre> </div> <div style="border: 1px solid black; padding: 5px; margin-top: 10px;"> <p style="text-align: center;">⚠ Caution</p> <ul style="list-style-type: none"> During a 75°C hot water supply operation with ANTI BACTERIA, the remote controller does not display 75°C. Be careful not to burn yourself; Output water may be hotter than that displayed on the remote controller. </div> <p>Related FC</p> <table border="1" style="width: 100%; border-collapse: collapse;"> <thead> <tr> <th style="text-align: center;">FC No.</th> <th style="text-align: center;">Setting item</th> <th style="text-align: center;">Default</th> <th style="text-align: center;">Setting available range</th> </tr> </thead> <tbody> <tr> <td style="text-align: center;">0A</td> <td>Anti bacteria set temperature</td> <td style="text-align: center;">75°C</td> <td style="text-align: center;">70-80°C</td> </tr> <tr> <td style="text-align: center;">0B</td> <td>Anti bacteria holding time</td> <td style="text-align: center;">30 mins</td> <td style="text-align: center;">0 - 60 mins</td> </tr> <tr> <td style="text-align: center;">Remote control 0C</td> <td>Anti bacteria start time</td> <td style="text-align: center;">22:00</td> <td style="text-align: center;">0:00-22:00</td> </tr> <tr> <td style="text-align: center;">Remote control 0D</td> <td>Anti bacteria operation cycle</td> <td style="text-align: center;">7 days</td> <td style="text-align: center;">Every day to 10 days</td> </tr> </tbody> </table>	FC No.	Setting item	Default	Setting available range	0A	Anti bacteria set temperature	75°C	70-80°C	0B	Anti bacteria holding time	30 mins	0 - 60 mins	Remote control 0C	Anti bacteria start time	22:00	0:00-22:00	Remote control 0D	Anti bacteria operation cycle	7 days	Every day to 10 days
FC No.	Setting item	Default	Setting available range																		
0A	Anti bacteria set temperature	75°C	70-80°C																		
0B	Anti bacteria holding time	30 mins	0 - 60 mins																		
Remote control 0C	Anti bacteria start time	22:00	0:00-22:00																		
Remote control 0D	Anti bacteria operation cycle	7 days	Every day to 10 days																		

Item	Operation flow and applicable data, etc.																
8-2. Operation Mode and Control Method	<p>9) Night set back (NIGHT SET BACK) operation A night set back operation performs heating at 5°K lower and cooling at 5°K temperatures against the remote controller set temperature from the setting start time (22:00) to the end time (6:00) every day.</p> <p>Note) • Set the remote controller time before starting a NIGHT SET BACK operation. • The set time can be changed with remote controller FC.</p> <p>Related FC</p> <table border="1" data-bbox="328 501 1318 663"> <thead> <tr> <th>FC No.</th> <th>Setting item</th> <th>Default</th> <th>Setting available range</th> </tr> </thead> <tbody> <tr> <td>Remote controller OE</td> <td>Night set back start Time setting</td> <td>22:00</td> <td>0:00-23:00</td> </tr> <tr> <td>Remote controller OF</td> <td>Night set back end Time setting</td> <td>6:00</td> <td>0:00-23:00</td> </tr> <tr> <td>26</td> <td>Night set back setting Temperature width</td> <td>5 deg</td> <td>3 -20 deg</td> </tr> </tbody> </table>	FC No.	Setting item	Default	Setting available range	Remote controller OE	Night set back start Time setting	22:00	0:00-23:00	Remote controller OF	Night set back end Time setting	6:00	0:00-23:00	26	Night set back setting Temperature width	5 deg	3 -20 deg
FC No.	Setting item	Default	Setting available range														
Remote controller OE	Night set back start Time setting	22:00	0:00-23:00														
Remote controller OF	Night set back end Time setting	6:00	0:00-23:00														
26	Night set back setting Temperature width	5 deg	3 -20 deg														
	<p>10) FROST PROTECTION operation A frost protection operation performs heating at the set temperature RSC_F = 15°C (FC).</p> <p>1) How to operate</p> <ul style="list-style-type: none"> • Pressing the remote controller [ZONE1, 2] button and then the [FROST PROTECTION] button starts a heating operation at the set temperature of 15°C. • Pressing again the [FROST PROTECTION] button cancels the FROST PROTECTION operation. • The remote controller displays "F" as the temperature during FROST PROTECTION. • A set temperature change during a FROST PROTECTION operation cancels the operation. <p>Related FC</p> <table border="1" data-bbox="328 1003 1318 1093"> <thead> <tr> <th>FC No.</th> <th>Setting item</th> <th>Default</th> <th>Setting available range</th> </tr> </thead> <tbody> <tr> <td>3A</td> <td>FROST PROTECTION Yes / No</td> <td>1: Yes</td> <td>0: No</td> </tr> <tr> <td>3B</td> <td>FROST PROTECTION Set temperature</td> <td>15°C</td> <td>10-20°C</td> </tr> </tbody> </table>	FC No.	Setting item	Default	Setting available range	3A	FROST PROTECTION Yes / No	1: Yes	0: No	3B	FROST PROTECTION Set temperature	15°C	10-20°C				
FC No.	Setting item	Default	Setting available range														
3A	FROST PROTECTION Yes / No	1: Yes	0: No														
3B	FROST PROTECTION Set temperature	15°C	10-20°C														

Item	Operation flow and applicable data, etc.
------	--

8-2.
Operation
Mode and
Control Method

11) AUTO operation
An auto operation sets the water temperature TSC_F depending on the outside temperature TO by following the table below.





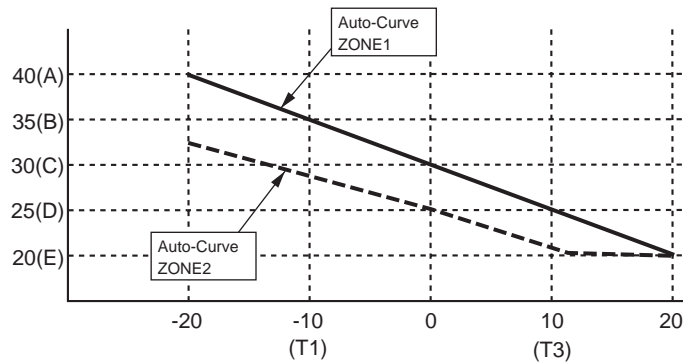



1) How to operate

- Pressing the remote controller [ZONE1, 2] button and then the [AUTO] button starts AUTO operation for heating. An operation starts at the set temperature of straight -line approximation for the following: water temperature 40°C with the outside temperature -20°C (FC), 35°C with -10 °C (T1)(FC), 30°C with 0°C (FC), 25°C with 10°C (T3), and 20°C with 20°C (TC).
- For 2-temperature control, although Auto-Curve in ZONE2 shows 80% of that of ZONE1 (FC), the water temperature setting does not fall below 20°C.
- During an AUTO operation, pressing again the [AUTO] button returns to the usual manual set heating operation.
- The remote controller displays "A" as the temperature during an AUTO operation.
(When 2-temperature control is enabled, the remote controller displays "A" "A".)
- Long-pressing the [AUTO] button during an AUTO operation activates the Auto-Curve FC change mode, enabling the set Auto-Curve water temperature to be changed in the ±5K range. (FC_27)
- Even if the temperature setting is changed during an AUTO operation, the operation continues.
- An AUTO operation works with a heating operation only, not with a cooling or a hot water supply operation.



Related FC

FC No.	Setting item	Default	Setting available range
27	Set temperature shift with heating set to Auto	0	-5 to 5 k
29	Outside air temperature T1 temperature	-10°C	-15-0°C
2B	Outside air temperature T3 temperature	10°C	0-15°C
2C	Set temperature when out side air temperature is -20 °C.	40°C	20-55°C
2D	Set temperature when out side air temperature is -10 °C (T1).	35°C	20-55°C
2E	Set temperature when out side air temperature is 0 °C.	30°C	20-55°C
2F	Set temperature when out side air temperature is 10 °C (T3).	25°C	20-55°C
30	Set temperature when out side air temperature is 20 °C.	20°C	20-55°C
31	Auto-Curve ratio of ZONE2	80%	0-100%

Item	Operation flow and applicable data, etc.
8-2. Operation Mode and Control Method	<p>12) Nighttime low-noise operation A night time low-noise operation reduces operation frequency and the number of outdoor fan rotations for a certain period during nighttime as noise control for neighborhood.</p> <p>Maximum operation frequency 40.2 Hz (Hot water supply/ Heating/ Cooling) Maximum fan tap 460 rpm (802H-E) 500 rpm (1102H-E, 1402H-E)</p> <p>The nighttime low-noise operation is enabled/ disabled by changing the remote controller FC_09.</p> <p><How to set></p> <p>1) Press the TEMP.  and TEST  button at the same time for 4 seconds or longer. (Shifted to the nighttime low-noise setting mode) The Code No. field displays "09", and the DATA "0000", SETTING, and  being displayed blink.</p> <p>2) Press TIME   to set enable "1" or disable "0". Pressing SET  change DATA and SETTING display to be lit and the setting is confirmed. (When "1" as enable is set, the nighttime low-noise setting is enabled, the control starts at the set start time.)</p> <p>3) Press TEST  to exit the nighttime low-noise time setting mode. The SETTING and  goes out, returning to its original status.</p>

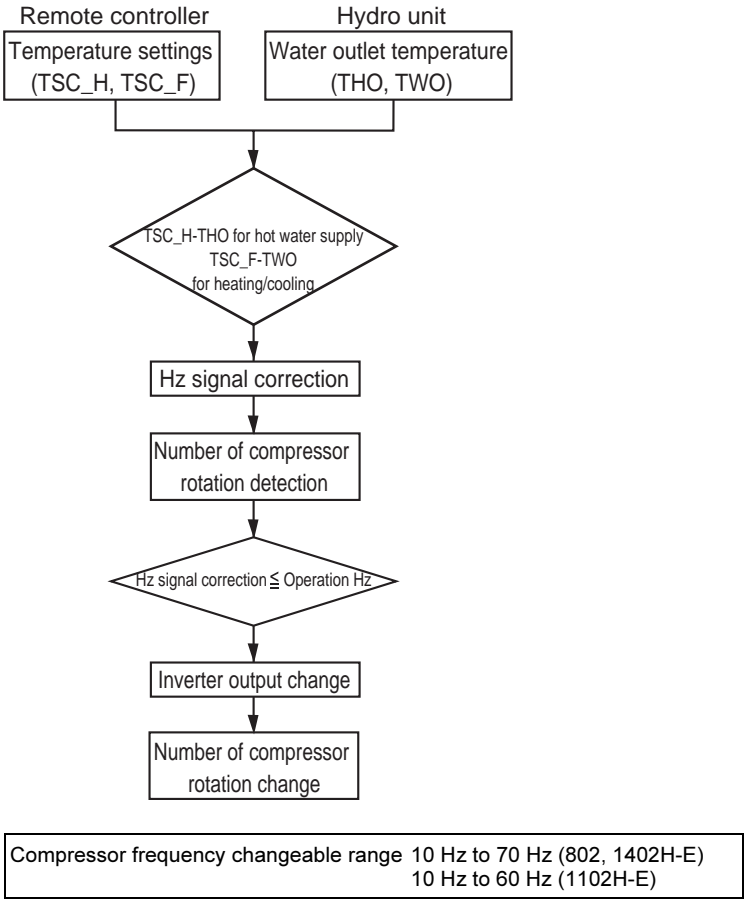
Item	Operation flow and applicable data, etc.
8-3. Hydro Unit Control	<p>1) Capacity control (compressor, high-temperature release, low-temperature release)</p> <p>This unit controls the compressor frequency and heater output so that the water outlet temperature matches the remote controller set temperature.</p> <p>1-1) Compressor control</p> <ul style="list-style-type: none"> • Calculates the different between the remote controller set temperature (TSC_H, TSC_F) and the water outlet temperature (Hot water supply: THO, Heating: TWO). • Sets the Hz signal correction amount that determines the number of compressor rotations by the temperature difference. • Detects the number of compressor rotations. • Compares the Hz signal correction amount and the current operation Hz, and changes the compressor output according to the difference. <p>* The control details are the same for hot water supply, heating, and cooling.</p> <div style="text-align: center;">  <pre> graph TD subgraph Remote_controller [Remote controller] A[Temperature settings (TSC_H, TSC_F)] end subgraph Hydro_unit [Hydro unit] B[Water outlet temperature (THO, TWO)] end A --> C{ } B --> C C --> D[TSC_H-THO for hot water supply TSC_F-TWO for heating/cooling] D --> E[Hz signal correction] E --> F[Number of compressor rotation detection] F --> G{Hz signal correction ≤ Operation Hz} G --> H[Inverter output change] H --> I[Number of compressor rotation change] </pre> <p>Compressor frequency changeable range 10 Hz to 70 Hz (802, 1402H-E) 10 Hz to 60 Hz (1102H-E)</p> </div>

Item	Operation flow and applicable data, etc.																																																						
8-3. Hydro Unit Control	<p>1-2) High temperature release control</p> <p>A heat pump operation is performed as shown in the table below according to the TC sensor detecting temperature.</p> <ul style="list-style-type: none"> For the detected temperature, TC (= TWO + 2 degree) of a heat pump operation is used. The values of T7 through T10 vary depending on TWI. (See the table below) If the compressor frequency instruction from the hydro unit is less than 10 Hz, the compressor stops. TC > 62°C causes the compressor to stop abnormally. When the compressor restarts 140 seconds after the stop and TC > 62°C is not detected for 20 minutes, the abnormal stop counter is cleared. 10 times of compressor abnormal stop stops the operation of heat pump, and confirms the abnormality (Display: A11). * If the heat pump operation is switched to other operation, the abnormality detection counter is reset to 0. <div style="display: flex; justify-content: space-between; align-items: flex-start;"> <div data-bbox="389 562 890 831" style="width: 45%;"> <p>TC (TWO+2)</p> </div> <div data-bbox="967 562 1453 819" style="width: 45%;"> <table border="1"> <thead> <tr> <th>Zone</th> <th>Control operation</th> </tr> </thead> <tbody> <tr> <td>R1</td> <td>Increase compressor frequency by 1.2 Hz every 60 secs.</td> </tr> <tr> <td>R2</td> <td>Increase compressor frequency by 0.6 Hz every 60 secs.</td> </tr> <tr> <td>O</td> <td>Decrease compressor frequency to 70% every 10 secs.</td> </tr> <tr> <td>P</td> <td>Decrease compressor frequency by 3 Hz every 10 secs.</td> </tr> <tr> <td>Q</td> <td>Keep compressor frequency.</td> </tr> </tbody> </table> </div> </div> <div style="display: flex; justify-content: space-between; margin-top: 10px;"> <div data-bbox="328 857 478 882">TC=TWO+2deg</div> <div data-bbox="884 857 925 882">(°C)</div> </div> <table border="1" data-bbox="328 896 938 1099" style="width: 100%; text-align: center;"> <thead> <tr> <th>TWI</th> <th>T7</th> <th>T8</th> <th>T9</th> <th>T10</th> <th>T11</th> </tr> </thead> <tbody> <tr> <td>TWI<30</td> <td>57.0</td> <td>59.0</td> <td>60.0</td> <td>61.0</td> <td>62.0</td> </tr> <tr> <td>30 ≤ TWI<35</td> <td>57.0</td> <td>59.0</td> <td>60.0</td> <td>61.0</td> <td>62.0</td> </tr> <tr> <td>35 ≤ TWI<40</td> <td>56.5</td> <td>58.5</td> <td>59.5</td> <td>60.5</td> <td>62.0</td> </tr> <tr> <td>40 ≤ TWI<45</td> <td>56.5</td> <td>58.5</td> <td>59.5</td> <td>60.5</td> <td>62.0</td> </tr> <tr> <td>45 ≤ TWI<50</td> <td>56.0</td> <td>58.0</td> <td>59.0</td> <td>60.0</td> <td>62.0</td> </tr> <tr> <td>50 ≤ TWI</td> <td>56.0</td> <td>58.0</td> <td>59.0</td> <td>60.0</td> <td>62.0</td> </tr> </tbody> </table>	Zone	Control operation	R1	Increase compressor frequency by 1.2 Hz every 60 secs.	R2	Increase compressor frequency by 0.6 Hz every 60 secs.	O	Decrease compressor frequency to 70% every 10 secs.	P	Decrease compressor frequency by 3 Hz every 10 secs.	Q	Keep compressor frequency.	TWI	T7	T8	T9	T10	T11	TWI<30	57.0	59.0	60.0	61.0	62.0	30 ≤ TWI<35	57.0	59.0	60.0	61.0	62.0	35 ≤ TWI<40	56.5	58.5	59.5	60.5	62.0	40 ≤ TWI<45	56.5	58.5	59.5	60.5	62.0	45 ≤ TWI<50	56.0	58.0	59.0	60.0	62.0	50 ≤ TWI	56.0	58.0	59.0	60.0	62.0
Zone	Control operation																																																						
R1	Increase compressor frequency by 1.2 Hz every 60 secs.																																																						
R2	Increase compressor frequency by 0.6 Hz every 60 secs.																																																						
O	Decrease compressor frequency to 70% every 10 secs.																																																						
P	Decrease compressor frequency by 3 Hz every 10 secs.																																																						
Q	Keep compressor frequency.																																																						
TWI	T7	T8	T9	T10	T11																																																		
TWI<30	57.0	59.0	60.0	61.0	62.0																																																		
30 ≤ TWI<35	57.0	59.0	60.0	61.0	62.0																																																		
35 ≤ TWI<40	56.5	58.5	59.5	60.5	62.0																																																		
40 ≤ TWI<45	56.5	58.5	59.5	60.5	62.0																																																		
45 ≤ TWI<50	56.0	58.0	59.0	60.0	62.0																																																		
50 ≤ TWI	56.0	58.0	59.0	60.0	62.0																																																		
	<p>1-3) Low temperature release control</p> <p>A heat pump operation is performed as shown in the table below according to the TC sensor detecting temperature.</p> <ul style="list-style-type: none"> For the detected temperature, TC = TWO of a heat pump operation is used. The values of T7 through T10 varies depending on TWI. (See the table below) If the compressor frequency instruction from the hydro unit is less than 10 Hz, the compressor stops. TC < 3°C causes the compressor to stop abnormally. When the compressor restarts when 140 seconds has passed after the stop and TC < 3°C is not detected for 20 minutes, the abnormal stop counter is cleared. 10 times of compressor abnormal stop stops the operation of heat pump, and confirms the abnormality (Display: A11). * If the heat pump operation is switched to other operation, the abnormality detection counter is reset to 0. <div style="display: flex; justify-content: space-between; align-items: flex-start;"> <div data-bbox="389 1406 890 1686" style="width: 45%;"> <p>TC (TWO)</p> </div> <div data-bbox="967 1406 1453 1664" style="width: 45%;"> <table border="1"> <thead> <tr> <th>Zone</th> <th>Control operation</th> </tr> </thead> <tbody> <tr> <td>R1</td> <td>Increase compressor frequency by 1.2 Hz every 60 secs.</td> </tr> <tr> <td>R2</td> <td>Increase compressor frequency by 0.6 Hz every 60 secs.</td> </tr> <tr> <td>O</td> <td>Decrease compressor frequency to 70% every 10 secs.</td> </tr> <tr> <td>P</td> <td>Decrease compressor frequency by 3 Hz every 10 secs.</td> </tr> <tr> <td>Q</td> <td>Keep compressor frequency.</td> </tr> </tbody> </table> </div> </div> <div style="display: flex; justify-content: space-between; margin-top: 10px;"> <div data-bbox="328 1709 419 1733">TC=TWO</div> <div data-bbox="884 1709 925 1733">(°C)</div> </div> <table border="1" data-bbox="328 1747 938 1892" style="width: 100%; text-align: center;"> <thead> <tr> <th>TWI</th> <th>T7</th> <th>T8</th> <th>T9</th> <th>T10</th> <th>T11</th> </tr> </thead> <tbody> <tr> <td>TWI<10</td> <td>10.0</td> <td>8.0</td> <td>6.0</td> <td>4.0</td> <td>3.0</td> </tr> <tr> <td>10 ≤ TWI<15</td> <td>10.5</td> <td>8.5</td> <td>6.5</td> <td>4.5</td> <td>3.0</td> </tr> <tr> <td>15 ≤ TWI<20</td> <td>11.0</td> <td>9.0</td> <td>7.0</td> <td>5.0</td> <td>3.0</td> </tr> <tr> <td>20 ≤ TWI</td> <td>11.5</td> <td>9.5</td> <td>7.5</td> <td>5.5</td> <td>3.0</td> </tr> </tbody> </table>	Zone	Control operation	R1	Increase compressor frequency by 1.2 Hz every 60 secs.	R2	Increase compressor frequency by 0.6 Hz every 60 secs.	O	Decrease compressor frequency to 70% every 10 secs.	P	Decrease compressor frequency by 3 Hz every 10 secs.	Q	Keep compressor frequency.	TWI	T7	T8	T9	T10	T11	TWI<10	10.0	8.0	6.0	4.0	3.0	10 ≤ TWI<15	10.5	8.5	6.5	4.5	3.0	15 ≤ TWI<20	11.0	9.0	7.0	5.0	3.0	20 ≤ TWI	11.5	9.5	7.5	5.5	3.0												
Zone	Control operation																																																						
R1	Increase compressor frequency by 1.2 Hz every 60 secs.																																																						
R2	Increase compressor frequency by 0.6 Hz every 60 secs.																																																						
O	Decrease compressor frequency to 70% every 10 secs.																																																						
P	Decrease compressor frequency by 3 Hz every 10 secs.																																																						
Q	Keep compressor frequency.																																																						
TWI	T7	T8	T9	T10	T11																																																		
TWI<10	10.0	8.0	6.0	4.0	3.0																																																		
10 ≤ TWI<15	10.5	8.5	6.5	4.5	3.0																																																		
15 ≤ TWI<20	11.0	9.0	7.0	5.0	3.0																																																		
20 ≤ TWI	11.5	9.5	7.5	5.5	3.0																																																		

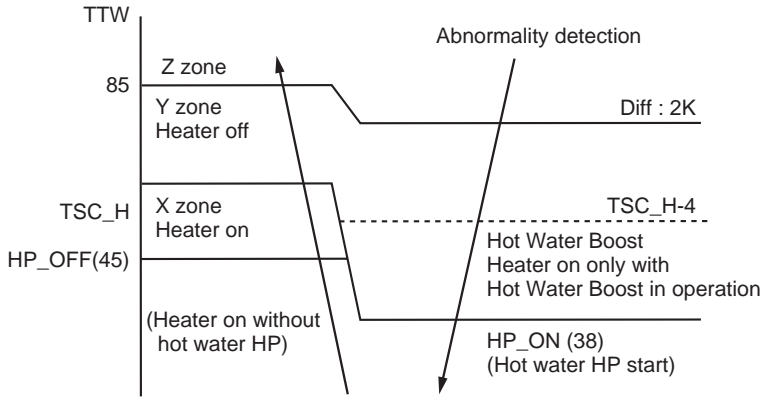
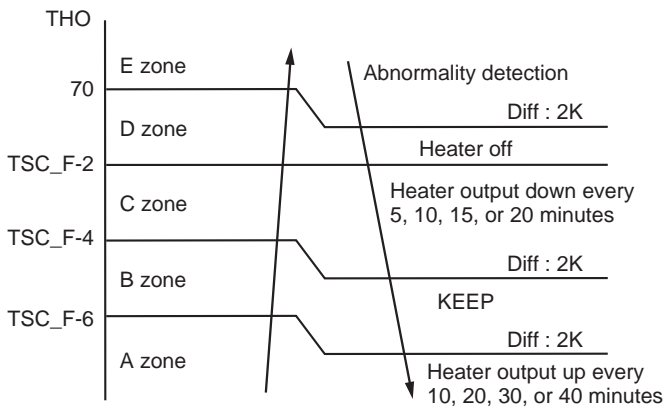
Item	Operation flow and applicable data, etc.						
8-3. Hydro Unit Control	<p>2) Heater control</p> <p>2-1) Hot water supply operation</p> <p>During a hot water heat pump operation, the unit energizes the hot water cylinder heater (2.75 kW) when all the following conditions are met. Note that when the hot water supply set temperature (TSC_F) is reached, the unit stops energizing the heater.</p> <ul style="list-style-type: none"> • When 30 minutes has passed after the hot water heat pump operation started. • The water inlet temperature (TWI) reaches 50°C. • The hot water cylinder sensor reaches the HP_OFF temperature (45°C-FC). • The HP_ON temperature (38°C-FC) is reached without the hot water HP status. • HOT WATER BOOST operation is in progress. 						
	<p>2-2) Heating operation</p> <p>1) Heater control at the time of heat pump operation</p> <ul style="list-style-type: none"> • Object to be controlled: Backup heater <p>The backup heater control starts when 13 minutes has passed after the heating heat pump operation started and select the ZONE (A-D). The backup heater control increases, decreases, or maintains the number of heaters every 10 minutes (FC) depending on the difference between the heating set temperature (TSC_F) and the heater outlet temperature (THO). When the heating set temperature (TSC_F) is reached, the hydro stops energizing the backup heater.</p>  <table border="1" data-bbox="363 1686 930 1778"> <thead> <tr> <th>Status</th> <th>Heater ON / OFF</th> </tr> </thead> <tbody> <tr> <td>Heater 1</td> <td>Backup heater 3 kW = ON</td> </tr> <tr> <td>Heater 2</td> <td>Backup heater 9 kW = ON</td> </tr> </tbody> </table> <p>The single-phase model of 3 kW has the backup heater 1 only. The three-phase model of 6 kW has heater 1+2 of 6 kW.</p>	Status	Heater ON / OFF	Heater 1	Backup heater 3 kW = ON	Heater 2	Backup heater 9 kW = ON
Status	Heater ON / OFF						
Heater 1	Backup heater 3 kW = ON						
Heater 2	Backup heater 9 kW = ON						

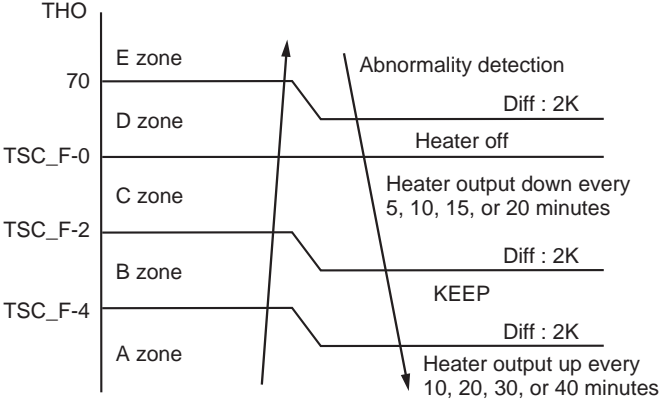
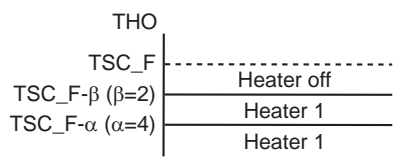
Item	Operation flow and applicable data, etc.																												
8-3. Hydro Unit Control	<p>2) Control at the time of heating heater operation</p> <ul style="list-style-type: none"> Controlled Object: Backup heater, Booster heater <p>The backup heater control starts when 13 minutes has passed after the heating heat pump operation started. The backup heater control increases, decreases, or maintains the number of heaters every 10 minutes (FC) depending on the difference between the heating set temperature (TSC_F) and the heater outlet temperature (THO). Note that when the heating set temperature (TSC_F) is reached, the unit stops energizing the heater.</p>  <table border="1" data-bbox="367 907 933 1030"> <thead> <tr> <th>Status</th> <th>Heater ON / OFF</th> </tr> </thead> <tbody> <tr> <td>Heater 1</td> <td>Backup heater 3 kW = ON</td> </tr> <tr> <td>Heater 2</td> <td>Backup heater 9 kW = ON</td> </tr> <tr> <td>Heater 3</td> <td>Heater 2 + Booster heater</td> </tr> </tbody> </table> <p>The single-phase model of 3 kW has the backup heater 1 only. The three-phase model of 6 kW has heater 1+2 of 6 kW. Contact point output only is available for booster heater.</p> <p>Related FC</p> <table border="1" data-bbox="327 1176 1316 1332"> <thead> <tr> <th>FC No.</th> <th>Setting item</th> <th>Default</th> <th>Setting available range</th> </tr> </thead> <tbody> <tr> <td>20</td> <td>Hot water supply heat pump start temperature</td> <td>38°C</td> <td>20-45°C</td> </tr> <tr> <td>21</td> <td>Hot water supply heat pump stop temperature</td> <td>45°C</td> <td>40-50°C</td> </tr> <tr> <td>33</td> <td>Heater control of down time</td> <td>1:10 mins</td> <td>0:5 mins 2:15 mins 3:20 mins</td> </tr> <tr> <td>34</td> <td>Heater control of up time</td> <td>0:10 mins</td> <td>1:20 mins 2:30 mins 3:40 mins</td> </tr> </tbody> </table>	Status	Heater ON / OFF	Heater 1	Backup heater 3 kW = ON	Heater 2	Backup heater 9 kW = ON	Heater 3	Heater 2 + Booster heater	FC No.	Setting item	Default	Setting available range	20	Hot water supply heat pump start temperature	38°C	20-45°C	21	Hot water supply heat pump stop temperature	45°C	40-50°C	33	Heater control of down time	1:10 mins	0:5 mins 2:15 mins 3:20 mins	34	Heater control of up time	0:10 mins	1:20 mins 2:30 mins 3:40 mins
Status	Heater ON / OFF																												
Heater 1	Backup heater 3 kW = ON																												
Heater 2	Backup heater 9 kW = ON																												
Heater 3	Heater 2 + Booster heater																												
FC No.	Setting item	Default	Setting available range																										
20	Hot water supply heat pump start temperature	38°C	20-45°C																										
21	Hot water supply heat pump stop temperature	45°C	40-50°C																										
33	Heater control of down time	1:10 mins	0:5 mins 2:15 mins 3:20 mins																										
34	Heater control of up time	0:10 mins	1:20 mins 2:30 mins 3:40 mins																										
	<p>2-3) Heater control at the time of defrosting</p> <ul style="list-style-type: none"> Object to be controlled: Backup heater <p>When a defrosting operation starts during the heating heat pump operation, the unit energizes a backup heater (3 kW) according to the heater outlet temperature sensor (THO) and the set temperature (TSC_F) as follows.</p>  <p>1) When the heater outlet temperature sensor (THO) drops to the temperature of 2°C below the set temperature</p> <p>Defrosting ends according to the usual heater control.</p> <table border="1" data-bbox="965 1568 1444 1635"> <thead> <tr> <th>Status</th> <th>Heater ON / OFF</th> </tr> </thead> <tbody> <tr> <td>Heater 1</td> <td>Backup heater 3 kW = ON</td> </tr> </tbody> </table>	Status	Heater ON / OFF	Heater 1	Backup heater 3 kW = ON																								
Status	Heater ON / OFF																												
Heater 1	Backup heater 3 kW = ON																												
	<p>2-4) Forcible heater energization</p> <p>To prevent freeze, the unit energizes or stops energizing a backup heater (3 kW) regardless of the unit status, not operated or in operation.</p> <ul style="list-style-type: none"> Object to be controlled: Backup heater <p>1) Energization start condition: $TWO < 4$ or $TWI < 4$ or $THO < 4$ 2) Energization stop condition: $TWO \geq 5$ and $TWI \geq 5$ and $THO \geq 5$ Defrosting ends according to the usual heater control.</p>																												
	<p>2-5) No heater operation</p> <p>According to the DP_SW11 setting, the unit switches the energize/ not energize for the hot water cylinder, backup heater, and booster. For details, see 10-1.</p>																												

Item	Operation flow and applicable data, etc.																		
8-3. Hydro Unit Control	<p>3) Circulation pump control One circulation pump (enhancing pump P2) can be connected to the unit in addition to the built-in circulation pump P1. DP_SW10-1, 3 within the water heat exchanger enables the built-in pump P1 to be set either to usual energization or only HP and backup heater energization, and also enables the enhancing pump P2 to be set either to interlocked or non-interlocked with the built-in pump.</p> <table border="1" data-bbox="347 439 1184 669"> <thead> <tr> <th>Item</th> <th>Heater ON / OFF</th> <th>Initial value</th> <th>Switch</th> </tr> </thead> <tbody> <tr> <td rowspan="3">AC pump</td> <td>01: None</td> <td></td> <td></td> </tr> <tr> <td>02: None</td> <td></td> <td></td> </tr> <tr> <td>03: Enhanced pump (P2) Interlock / Non-interlock with built-in pump</td> <td>OFF: Interlock^{*2}</td> <td>SW10-3</td> </tr> <tr> <td>Existence & position setting</td> <td>04: None</td> <td></td> <td></td> </tr> </tbody> </table> <p>*1 The pump 1 in HP operates only in hot water supply side. *2 Setting the enhancing pump P2 to non-interlock sets the pump P1 to usual energization.</p> <p>3-1) Circulation pump (Built-in pump P1) Pump type: AC motor, rated voltage 230V, manually changeable 3-level pump speed</p> <p>The pump operation starts when the following condition is met.</p> <ul style="list-style-type: none"> The [HOT WATER] or [ZONE1, 2] button is pressed. <p>The pump operation ends when the following condition is met.</p> <ul style="list-style-type: none"> Pressing the [HOT WATER] or [ZONE1, 2] button stops the about 1 minute later. <p>The pump operation stops or re-starts as follows:</p> <ul style="list-style-type: none"> Stops for 30 seconds when the operation mode changes. Stops the pump when a boiler instruction is given and $70^{\circ}\text{C} \leq \text{TWI}$ or TWO or THO is met. Re-starts the pump when a boiler instruction is given and $65^{\circ}\text{C} > \text{TWI}$ and TWO and THO is met. <p>Operation when DP_SW10-1 "ON: HP operation only" is selected</p> <ul style="list-style-type: none"> The pump stops only when the hot water cylinder heater is in operation. The pump does not stop with the heating thermostat off. <p>3-2) Circulation pump (Enhanced pump P2) Pump type: AC motor, rated voltage 230V, directly connectable to the unit with the rated output of up to 200W. DP_SW10-3 enables the pump P2 to be set either to interlock or non-interlock with the built-in pump P1. Setting to non-interlock sets the pump1 to usual energization.</p>	Item	Heater ON / OFF	Initial value	Switch	AC pump	01: None			02: None			03: Enhanced pump (P2) Interlock / Non-interlock with built-in pump	OFF: Interlock ^{*2}	SW10-3	Existence & position setting	04: None		
Item	Heater ON / OFF	Initial value	Switch																
AC pump	01: None																		
	02: None																		
	03: Enhanced pump (P2) Interlock / Non-interlock with built-in pump	OFF: Interlock ^{*2}	SW10-3																
Existence & position setting	04: None																		
	<p>4) Flow switch operation</p> <p>Setting the flow switch to On or OFF determines whether water flows in the water heat exchanger.</p> <table border="1" data-bbox="328 1447 1082 1536"> <thead> <tr> <th>Model</th> <th>Criteria for water flowing</th> <th>Criteria for water not flowing</th> </tr> </thead> <tbody> <tr> <td>HWS-802**-E</td> <td>Flow 13 L/min or more</td> <td>Flow less than 13 L/min</td> </tr> <tr> <td>HWS-1402**-E</td> <td>Flow 17.5 L/min or more</td> <td>Flow less than 17.5 L/min</td> </tr> </tbody> </table> <p>When start the hot water supply, heating, or cooling operation, failure to determine whether water flows does not energize HP, the backup heater, and booster heater. The "A01" error code display also blinks in this case.</p>	Model	Criteria for water flowing	Criteria for water not flowing	HWS-802**-E	Flow 13 L/min or more	Flow less than 13 L/min	HWS-1402**-E	Flow 17.5 L/min or more	Flow less than 17.5 L/min									
Model	Criteria for water flowing	Criteria for water not flowing																	
HWS-802**-E	Flow 13 L/min or more	Flow less than 13 L/min																	
HWS-1402**-E	Flow 17.5 L/min or more	Flow less than 17.5 L/min																	

Item **Operation flow and applicable data, etc.**

8-3. Hydro Unit Control

5) Mixing Valve control (2-temperature heating control)
 To set different radiator unit supply temperatures or floor heating supply temperatures, the unit performs Mixing Valve control.
 When Mixing Valve "Yes" is selected, the unit controls Mixing Valve every 4 minutes (FC) based on the difference $TSC_{\Delta}T$ between the Zone2 set temperature and TFI (floor inlet water temperature sensor) temperature as follows:

TSC_ΔT	$2 \leq TSC_{\Delta}T$	$-2 \leq TSC_{\Delta}T < 2$	$-2 > TSC_{\Delta}T$
Control value	+ 1 step (Open)	± 0 step	- 1 step (Close)

Initial value	Driving range	1 step	Control cycle
6	0-12	3 WV move 7.5 degs	4 mins (FC)

For 2-temperature control, DP_SW12-3 Zone2 "Yes" must be selected.

Related FC

FC No.	Setting item	Default	Setting available range
0C	Mixing Valve operation time	60	30 - 240 secs
59	Mixing Valve control time	4	1 - 30 mins

6) Q-H characteristics of hydro unit
 The following shows the Q-H characteristics.

6-1) HWS-801XWHM3-E, T6-E

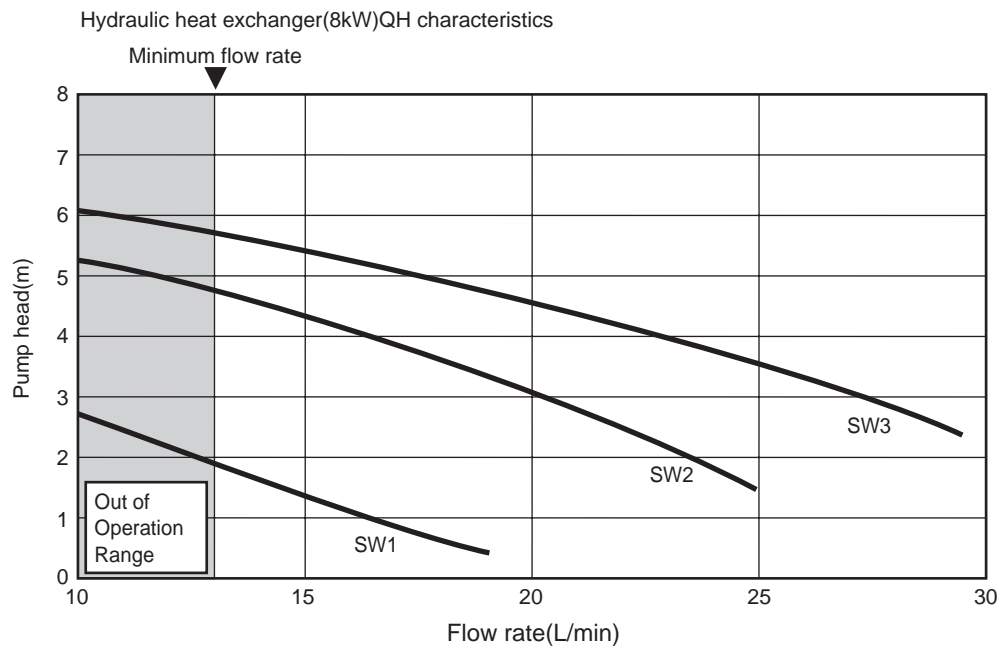

6-2) HWS-1402XWHM3-E, T6-E, T9-E

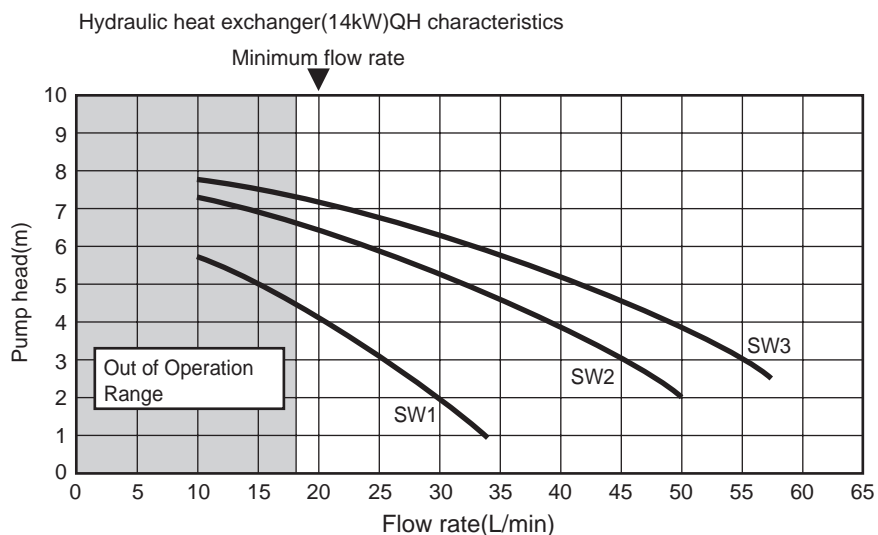

Item	Operation flow and applicable data, etc.
8-3. Hydro Unit Control	<p>7) Automatic restart control The unit records operation information before a power outage and retrieves the information after the power is on again to restart automatically the operation with the information.</p> <p>7-1) Operation during remote controller</p> <ul style="list-style-type: none"> • The operation status before a power outage automatically restarts after the power is on again. (The merit functions are also enabled) • Approximately 6 hours or more after a power outage The operation status before a power outage automatically restarts after the power is on again. But the merit functions (Night Set Back, Anti Bacteria) are disabled. The remote controller time displays "--:--". (The merit functions are disabled) <p>7-2) Operation during forcible automatic operation A forcible automatic operation is performed when the power is on again after a power outage.</p> <p>7-3) Operation during defrosting operation When the power is on again after a power outage, the usual operation restarts. Note: The operation details recorded before a power outage</p> <p>Operation mode: Hot water supply, Heating, Cooling, Hot water supply + Heating, Hot water supply + Cooling Set temperature: Hot water set temperature, Heating set temperature, Cooling set temperature</p> <p>Merit function: Hot water supply operation (Anti Bacteria) Heating operation (Night Set Back)</p>
	<p>8) Piping freeze prevention control This control operates when the power is on regardless the remote controller setting ON or OFF. To prevent frost bursting of the water piping for hot water supply and heating, the unit flows water with the circulation pump when the temperature sensor value falls below a certain temperature.</p> <p>8-1) Piping freeze prevention control 1</p> <ol style="list-style-type: none"> 1) Start condition: TWO < 4°C or THWI < 4°C or THO < 4°C 2) End condition: TWO ≥ 5°C and TWI ≥ 5°C and THO ≥ 5°C <p>3)-1 How to operate (circulation pump)</p> <ul style="list-style-type: none"> • When the circulation pump is not in operation, if the sensor detects the freeze prevention control start temperature, the unit operate the circulation pump. • During a freeze prevention operation, a heat pump operation does not start. • When neither [HOT WATER] nor [ZONE1, 2] is in operation, if the end condition is not met when 3 minutes has passed after an operation starts, the unit performs the operation in 3)-2 to prevent freeze. <p>3)-2 How to operate (circulation pump + backup heater)</p> <ul style="list-style-type: none"> • When neither [HOT WATER] nor [ZONE1, 2] is in operation, if the end condition is not met when 3 minutes has passed after an operation starts. • End condition: TWO ≥ 5°C and TWI ≥ 5°C and THO ≥ 5°C • Heating with the set temperature 55°C operates. <p>3)-3 Abnormal stop</p> <ul style="list-style-type: none"> • If a freeze prevention operation continues for 30 minutes and does not meet the end condition, the operation stops as abnormal stop. (Remote controller check code: A5)

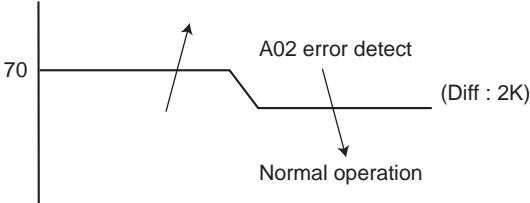
Item	Operation flow and applicable data, etc.
8-3. Hydro Unit Control	<p>8-2) Piping freeze prevention control 2 TC and TWO activates freeze prevention regardless of a heat pump operation mode. 1) Determination condition: $TWO > 20^{\circ}\text{C}$, $2^{\circ}\text{TC} + TWO < -12^{\circ}\text{C}$ is continuously detected for 30 seconds or longer. Or $TWO \leq 20^{\circ}\text{C}$, $\text{TC} + TWO < 4^{\circ}\text{C}$ is continuously detected for 30 seconds or longer.</p> <p>2) Determination cancellation conditions</p> <ul style="list-style-type: none"> The stop or operation mode is changed by the remote controller The mode is defrosting at the time of determination At the next time of defrosting, the start condition is not met. The mode is other than defrosting at the time of determination After cooling, heating, hot water heat pump restarts, the start condition is not met for 10 minutes. <p>3) Error display</p> <ul style="list-style-type: none"> If freeze determination cancellation condition is not met, A4 error is displayed. <p>8-3) Piping freeze prevention control 3 This control applies only when defrosting is in operation. 1) Determination condition: During defrosting, $\text{TWI} \leq 15^{\circ}\text{C}$ is continuously detected for 30 seconds or longer (After the stop, the unit restarts.)</p> <p>2) Determination cancellation condition</p> <ul style="list-style-type: none"> At the next time of defrosting, the start condition is not met. <p>3) Error display</p> <ul style="list-style-type: none"> If freeze determination cancellation condition is not met, A4 error is displayed. <p>8-4) Piping freeze prevention control 4 When the value of Ps sensor is low, freeze prevention is activated regardless of a heat pump operation mode. 1) Determination condition: Lo pressure sensor detects $\text{PS} < 0.2 \text{ MPa}$ and 30 seconds passes (defrosting and cooling) (During a defrosting operation for cooling and heating, or hot water supply) Lo pressure sensor detects $\text{PS} < 0.2 \text{ MPa}$ and 10 minutes passes (heating and hot water supply operation)</p> <p>2) Determination cancellation condition</p> <ul style="list-style-type: none"> After a restart, the start condition is not met for 30 minutes. At the next time of defrosting, the start condition is not met. (Defrosting operation for heating or hot water supply) <p>3) Error display</p> <ul style="list-style-type: none"> If freeze determination cancellation condition is not met, A8 error is displayed. <p>9) High return water protect control. The hydro unit protects against high return water which made by separate boiler system.</p> <p>TWI, TWO, THO</p>  <p>When A02 error appeared, the built-in pump will stop.</p>

Item	Operation flow and applicable data, etc.												
<p>3. Hydro Unit Control</p>	<p>10) Room temperature thermostat control (Option board TCB-PCMO3E is necessary. Connect the connection cable to the water heat exchange board CN211.) When the room thermostat is connected and heating or cooling operates with DP_SW12-4 set to ON, a room thermostat operation is performed.</p> <div style="display: flex; justify-content: space-around;"> <div data-bbox="823 304 1129 611"> <p>TCB-PCMO3E PJ17 6198674 Terminal label</p> </div> <div data-bbox="1145 304 1449 611"> <p>CN210 Red CN211 Black</p> </div> </div> <p>10-1) Heating thermostat operation When the heating room thermostat is OPEN, the usual heating AUTO operation is performed. After 30 minutes has passed, if the heating room thermostat continues to be in the OPEN status, the operation raises the water temperature by 1 degree every 30 minutes. The same heater control as that of the usual HP operation applies to the backup heater and booster heater.</p> <p>When the heating room thermostat is CLOSE, the heat pump performs thermostat off. During the thermostat off, the operation lowers the set water temperature by 1 deg every 30 minutes. When the thermostat off is completed, the backup heater and booster heater stops being energized.</p> <p>10-2) Cooling thermostat operation When the cooling room thermostat is CLOSE, the usual cooling operation is performed. (Initial set water temperature 20°C) After 30 minutes has passed, if the room thermostat continues to be in the OPEN status, the operation lowers the water temperature by 1°C every 30 minutes.</p> <p>When the cooling room thermostat is OPEN, the heat pump performs thermostat off. During the thermostat off, the operation raises the set water temperature by 1 degree every 30 minutes.</p> <table border="1" data-bbox="368 1088 1449 1279"> <thead> <tr> <th>Indoor thermostat contact point</th> <th>Correction control</th> <th>Heating operation</th> <th>Cooling operation</th> </tr> </thead> <tbody> <tr> <td>OPEN</td> <td>Setting shift UP</td> <td>Thermostat ON Up water temperature by 1 deg every 30 mins</td> <td>Thermostat OFF Lower water temperature by 1 deg every 30 mins</td> </tr> <tr> <td>CLOSE</td> <td>Setting shift DOWN</td> <td>Thermostat OFF Lower water temperature by 1 deg every 30 mins</td> <td>Thermostat ON Up water temperature by 1 deg every 30 mins</td> </tr> </tbody> </table>	Indoor thermostat contact point	Correction control	Heating operation	Cooling operation	OPEN	Setting shift UP	Thermostat ON Up water temperature by 1 deg every 30 mins	Thermostat OFF Lower water temperature by 1 deg every 30 mins	CLOSE	Setting shift DOWN	Thermostat OFF Lower water temperature by 1 deg every 30 mins	Thermostat ON Up water temperature by 1 deg every 30 mins
Indoor thermostat contact point	Correction control	Heating operation	Cooling operation										
OPEN	Setting shift UP	Thermostat ON Up water temperature by 1 deg every 30 mins	Thermostat OFF Lower water temperature by 1 deg every 30 mins										
CLOSE	Setting shift DOWN	Thermostat OFF Lower water temperature by 1 deg every 30 mins	Thermostat ON Up water temperature by 1 deg every 30 mins										
	<p>11) Forcible stop control (Option board TCB-PCMO3E is necessary. Connect the connection cable to the water heat exchange board CN210.) • When CLOSE occurs between "HEAT" and "COM" of TCB-PCMO3E, the RED LED on the option board lights and the operation (hot water supply, heating, cooling) stops. To restart the operation, use the operation button of the remote controller.</p>												
	<p>12) Output signal control 1 (Option board TCB-PCIN3E is necessary. Connect the connection cable to the water heat exchange board CN208.)</p> <ul style="list-style-type: none"> • If an error detecting signal is output, CLOSE occurs between the terminal 1 and 2. • If a boiler output signal is output, CLOSE occurs between the terminal 3 and 4. • In either signal above is output, the red LED on the Option board lights. 												
	<p>13) Output signal control 2 (Option board TCB-PCIN3E is necessary. Connect the connection cable to the water heat exchange board CN209.)</p> <ul style="list-style-type: none"> • When defrosting is in operation, CLOSE occurs between the terminal 1 and 2. • When the compressor is in operation, CLOSE occurs between the terminal 3 and 4. <p>In either signal above is output, the red LED on the OP board lights.</p> <div style="display: flex; justify-content: space-around;"> <div data-bbox="823 1648 1129 1984"> <p>TCB-PCIN3E PJ20 Terminal label</p> </div> <div data-bbox="1145 1648 1449 1984"> <p>CN208 Blue CN209 Green</p> </div> </div>												

Item	Operation flow and applicable data, etc.
8-4. Outdoor unit control	<p>1) PMV (Pulse motor valve) control Valve opening is controlled using the expansion valve with a pulse motor according to a heat pump operation status.</p> <ul style="list-style-type: none"> • PMV is controlled between 30 and 500 pulses during an operation. • At the time of a cooling operation, PMV is controlled with the usual target value of 1 to 4 K temperature difference between TS sensor and TC sensor. • At the time of a hot water supply or heating operation, PMV is controlled with the usual target value of 2 to 4 K (for 802H-E) or -1 to 4 K (for 1102, 1402H-E) temperature difference between TS sensor and TE sensor. • For both cooling and heating, if the cycle is overheated, PMV is controlled using the TD sensor. The usual target value is 91°C for a cooling operation, and 96°C for a heating operation. <p>* A defective sensor may cause liquid back flow or abnormal overheat of the compressor, significantly shortening the compressor life. If the compressor or other equipment is repaired, first check that the resistance of each sensor or the refrigerant cycle has no problem, then start the operation.</p> <hr/> <p>2) Discharge temperature release control This control detects an abnormality of the refrigerant cycle or compressor to perform failure prevention.</p> <ul style="list-style-type: none"> • This control reduces operation frequency if the PMV control does not lower the outlet temperature or if the outlet temperature rapidly rises. The frequency control is broken down to the unit of 0.6 Hz to stabilize the cycle. • If the discharge temperature detects the abnormal stop zone, the compressor stops and then restarts after 150 seconds. The abnormality detection counter is cleared when the operation continues for 10 minutes. If detected 4 times, the error code is displayed and the compressor does not restart. <p>* An abnormality could occur due to too less refrigerant, PMV defective, or cycle stuck.</p> <ul style="list-style-type: none"> • For details about an error displayed, see the check code list. <div style="text-align: center;"> </div>

Item	Operation flow and applicable data, etc.
------	--

8-4.
Outdoor unit control

3) Current release control
The number of compressor rotation is controlled so that current value of the compressor drive circuit does not exceed the specified value.

- The outdoor unit detects the input current.
- The outside air temperature is detected and used to set the specified value of current.
- The number of compressor rotation instructed by the hydro unit is used to determine whether the current value exceeds the specified value.
- If exceeds, the number of compressor rotation is reduced to the most approximate number instructed by the hydro unit within the specified value range.

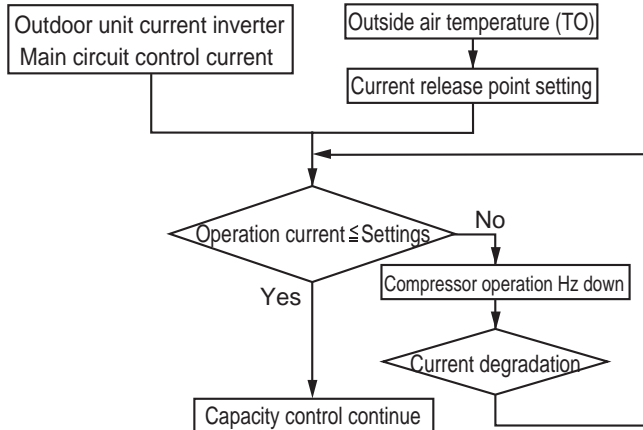

Heating

Outside temperature TO (degree °C)	Current release value (A)	
	802H-E	1102, 1402H-E
$35 \leq TO$	12.0	12.0
$15 \leq TO < 35$	$20.0 - (TO - 15) \times 0.4$	$20.0 - (TO - 15) \times 0.4$
$TO < 15$	20.0	20.0

Cooling

Outside temperature TO (degree °C)	Current release value (A)	
	802H-E	1102, 1402H-E
$44 \leq TO$	9.5	15.0
$39 \leq TO < 44$	13.0	17.7
$10 \leq TO < 39$	16.0	20.0

No cooling operation available for $TO < 10^\circ\text{C}$.

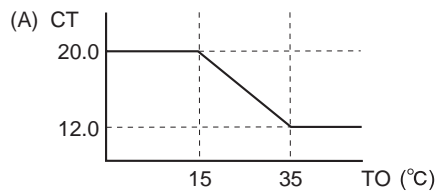

4) Current releases shift control

During a cooling operation, this control prevents the electronic parts, such as a compressor drive element, and compressor from failing.

- The current release control value (I) is selected from the following table according to the TO sensor value.

Current release control value (I)

Temperature range	802H-E	1102H-E	1402H-E
$50^\circ\text{C} \leq TO$	10.5	14.1	14.1
$45^\circ\text{C} \leq TO < 50^\circ\text{C}$	10.5	14.1	14.1
$39^\circ\text{C} \leq TO < 45^\circ\text{C}$	14.0	14.1	16.4
$TO < 39^\circ\text{C}$	16.0	14.1	16.4
TO abnormal	10.5	14.1	14.1

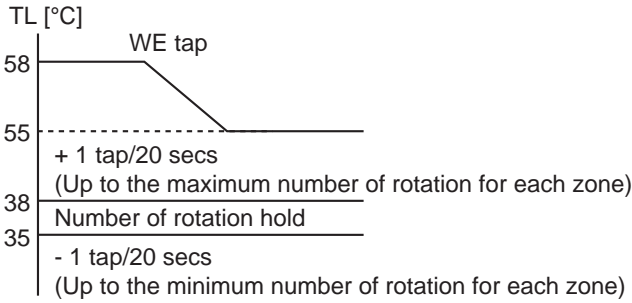
Item	Operation flow and applicable data, etc.																																																																																																																																																																																																																				
8-4. Outdoor unit control	<p>5) Outdoor fan control The outdoor side control part controls the number of fan motor rotations by receiving an operation instruction from the indoor side (Hydro unit) control part. * Although the fan motor is a DC motor, which has non-step variable numbers of rotations, it is limited to some steps for convenience of control.</p> <p>The number of fan tap rotation allocation [rpm]</p> <table border="1" data-bbox="328 472 1235 591"> <thead> <tr> <th></th> <th></th> <th>W1</th> <th>W2</th> <th>W3</th> <th>W4</th> <th>W5</th> <th>W6</th> <th>W7</th> <th>W8</th> </tr> </thead> <tbody> <tr> <td>802H-E</td> <td></td> <td>200</td> <td>230</td> <td>260</td> <td>300</td> <td>340</td> <td>380</td> <td>420</td> <td>460</td> </tr> <tr> <td rowspan="2">1102, 1402H-E</td> <td>Upper</td> <td>200</td> <td>240</td> <td>240</td> <td>260</td> <td>320</td> <td>380</td> <td>480</td> <td>500</td> </tr> <tr> <td>Lower</td> <td>200</td> <td>200</td> <td>200</td> <td>280</td> <td>360</td> <td>400</td> <td>500</td> <td>520</td> </tr> </tbody> </table> <table border="1" data-bbox="328 607 1144 725"> <thead> <tr> <th></th> <th></th> <th>W9</th> <th>WA</th> <th>WB</th> <th>WC</th> <th>WD</th> <th>WE</th> <th>WF</th> </tr> </thead> <tbody> <tr> <td>802H-E</td> <td></td> <td>520</td> <td>570</td> <td>600</td> <td>630</td> <td>670</td> <td>710</td> <td>740</td> </tr> <tr> <td rowspan="2">1102, 1402H-E</td> <td>Upper</td> <td>530</td> <td>610</td> <td>640</td> <td>660</td> <td>720</td> <td>780</td> <td>890</td> </tr> <tr> <td>Lower</td> <td>550</td> <td>630</td> <td>660</td> <td>700</td> <td>740</td> <td>820</td> <td>910</td> </tr> </tbody> </table> <p>5-1) Cooling fan control</p> <ul style="list-style-type: none"> The TL sensor, TO sensor and operation frequency control the outdoor fan. The control is performed by 1 tap of the DC fan control (14 taps). For 60 seconds after the start, the maximum fan tap for each zone that is shown in the following table is fixed. After that, the fan is controlled according to the TL sensor temperature. <p>TL [°C]</p>  <p>HWS-802H-E</p> <table border="1" data-bbox="328 1267 1206 1581"> <thead> <tr> <th rowspan="2">Temperature range</th> <th colspan="2">Less than 20 Hz</th> <th colspan="2">20 Hz or more to less than 45 Hz</th> <th colspan="2">45 Hz or more</th> </tr> <tr> <th>Minimum</th> <th>Maximum</th> <th>Minimum</th> <th>Maximum</th> <th>Minimum</th> <th>Maximum</th> </tr> </thead> <tbody> <tr> <td>38°C ≤ TO</td> <td>W6</td> <td>WC</td> <td>W8</td> <td>WE</td> <td>WA</td> <td>WE</td> </tr> <tr> <td>29°C ≤ TO < 38°C</td> <td>W5</td> <td>WB</td> <td>W7</td> <td>WD</td> <td>W9</td> <td>WD</td> </tr> <tr> <td>15°C ≤ TO < 29°C</td> <td>W4</td> <td>W8</td> <td>W6</td> <td>WA</td> <td>W8</td> <td>WC</td> </tr> <tr> <td>5°C ≤ TO < 15°C</td> <td>W3</td> <td>W6</td> <td>W5</td> <td>W8</td> <td>W7</td> <td>WA</td> </tr> <tr> <td>0°C ≤ TO < 5°C</td> <td>W2</td> <td>W4</td> <td>W4</td> <td>W6</td> <td>W5</td> <td>W8</td> </tr> <tr> <td>-4°C ≤ TO < 0°C</td> <td>W2</td> <td>W3</td> <td>W3</td> <td>W5</td> <td>W4</td> <td>W6</td> </tr> <tr> <td>TO < -4°C</td> <td>OFF</td> <td>OFF</td> <td>OFF</td> <td>W2</td> <td>OFF</td> <td>W3</td> </tr> <tr> <td>TO abnormal</td> <td>OFF</td> <td>WC</td> <td>OFF</td> <td>WE</td> <td>OFF</td> <td>WE</td> </tr> </tbody> </table> <p>HWS-1102H-E, 1402H-E</p> <table border="1" data-bbox="328 1637 1206 1966"> <thead> <tr> <th rowspan="2">Temperature range</th> <th colspan="2">Less than 20 Hz</th> <th colspan="2">20 Hz or more to less than 45 Hz</th> <th colspan="2">45 Hz or more</th> </tr> <tr> <th>Minimum</th> <th>Maximum</th> <th>Minimum</th> <th>Maximum</th> <th>Minimum</th> <th>Maximum</th> </tr> </thead> <tbody> <tr> <td>38°C ≤ TO</td> <td>W6</td> <td>WC</td> <td>W8</td> <td>WC</td> <td>WA</td> <td>WD</td> </tr> <tr> <td>29°C ≤ TO < 38°C</td> <td>W5</td> <td>WB</td> <td>W7</td> <td>WC (WB for 1102)</td> <td>W9</td> <td>WC</td> </tr> <tr> <td>15°C ≤ TO < 29°C</td> <td>W4</td> <td>W8</td> <td>W6</td> <td>WA</td> <td>W8</td> <td>WC</td> </tr> <tr> <td>5°C ≤ TO < 15°C</td> <td>W3</td> <td>W6</td> <td>W5</td> <td>W8</td> <td>W7</td> <td>WA</td> </tr> <tr> <td>0°C ≤ TO < 5°C</td> <td>W2</td> <td>W4</td> <td>W4</td> <td>W6</td> <td>W5</td> <td>W8</td> </tr> <tr> <td>-4°C ≤ TO < 0°C</td> <td>W2</td> <td>W3</td> <td>W3</td> <td>W5</td> <td>W4</td> <td>W6</td> </tr> <tr> <td>TO < -4°C</td> <td>W1</td> <td>W2</td> <td>W1</td> <td>W4</td> <td>W2</td> <td>W6</td> </tr> <tr> <td>TO abnormal</td> <td>W1</td> <td>WC</td> <td>W1</td> <td>WC</td> <td>W2</td> <td>WD</td> </tr> </tbody> </table>			W1	W2	W3	W4	W5	W6	W7	W8	802H-E		200	230	260	300	340	380	420	460	1102, 1402H-E	Upper	200	240	240	260	320	380	480	500	Lower	200	200	200	280	360	400	500	520			W9	WA	WB	WC	WD	WE	WF	802H-E		520	570	600	630	670	710	740	1102, 1402H-E	Upper	530	610	640	660	720	780	890	Lower	550	630	660	700	740	820	910	Temperature range	Less than 20 Hz		20 Hz or more to less than 45 Hz		45 Hz or more		Minimum	Maximum	Minimum	Maximum	Minimum	Maximum	38°C ≤ TO	W6	WC	W8	WE	WA	WE	29°C ≤ TO < 38°C	W5	WB	W7	WD	W9	WD	15°C ≤ TO < 29°C	W4	W8	W6	WA	W8	WC	5°C ≤ TO < 15°C	W3	W6	W5	W8	W7	WA	0°C ≤ TO < 5°C	W2	W4	W4	W6	W5	W8	-4°C ≤ TO < 0°C	W2	W3	W3	W5	W4	W6	TO < -4°C	OFF	OFF	OFF	W2	OFF	W3	TO abnormal	OFF	WC	OFF	WE	OFF	WE	Temperature range	Less than 20 Hz		20 Hz or more to less than 45 Hz		45 Hz or more		Minimum	Maximum	Minimum	Maximum	Minimum	Maximum	38°C ≤ TO	W6	WC	W8	WC	WA	WD	29°C ≤ TO < 38°C	W5	WB	W7	WC (WB for 1102)	W9	WC	15°C ≤ TO < 29°C	W4	W8	W6	WA	W8	WC	5°C ≤ TO < 15°C	W3	W6	W5	W8	W7	WA	0°C ≤ TO < 5°C	W2	W4	W4	W6	W5	W8	-4°C ≤ TO < 0°C	W2	W3	W3	W5	W4	W6	TO < -4°C	W1	W2	W1	W4	W2	W6	TO abnormal	W1	WC	W1	WC	W2	WD
		W1	W2	W3	W4	W5	W6	W7	W8																																																																																																																																																																																																												
802H-E		200	230	260	300	340	380	420	460																																																																																																																																																																																																												
1102, 1402H-E	Upper	200	240	240	260	320	380	480	500																																																																																																																																																																																																												
	Lower	200	200	200	280	360	400	500	520																																																																																																																																																																																																												
		W9	WA	WB	WC	WD	WE	WF																																																																																																																																																																																																													
802H-E		520	570	600	630	670	710	740																																																																																																																																																																																																													
1102, 1402H-E	Upper	530	610	640	660	720	780	890																																																																																																																																																																																																													
	Lower	550	630	660	700	740	820	910																																																																																																																																																																																																													
Temperature range	Less than 20 Hz		20 Hz or more to less than 45 Hz		45 Hz or more																																																																																																																																																																																																																
	Minimum	Maximum	Minimum	Maximum	Minimum	Maximum																																																																																																																																																																																																															
38°C ≤ TO	W6	WC	W8	WE	WA	WE																																																																																																																																																																																																															
29°C ≤ TO < 38°C	W5	WB	W7	WD	W9	WD																																																																																																																																																																																																															
15°C ≤ TO < 29°C	W4	W8	W6	WA	W8	WC																																																																																																																																																																																																															
5°C ≤ TO < 15°C	W3	W6	W5	W8	W7	WA																																																																																																																																																																																																															
0°C ≤ TO < 5°C	W2	W4	W4	W6	W5	W8																																																																																																																																																																																																															
-4°C ≤ TO < 0°C	W2	W3	W3	W5	W4	W6																																																																																																																																																																																																															
TO < -4°C	OFF	OFF	OFF	W2	OFF	W3																																																																																																																																																																																																															
TO abnormal	OFF	WC	OFF	WE	OFF	WE																																																																																																																																																																																																															
Temperature range	Less than 20 Hz		20 Hz or more to less than 45 Hz		45 Hz or more																																																																																																																																																																																																																
	Minimum	Maximum	Minimum	Maximum	Minimum	Maximum																																																																																																																																																																																																															
38°C ≤ TO	W6	WC	W8	WC	WA	WD																																																																																																																																																																																																															
29°C ≤ TO < 38°C	W5	WB	W7	WC (WB for 1102)	W9	WC																																																																																																																																																																																																															
15°C ≤ TO < 29°C	W4	W8	W6	WA	W8	WC																																																																																																																																																																																																															
5°C ≤ TO < 15°C	W3	W6	W5	W8	W7	WA																																																																																																																																																																																																															
0°C ≤ TO < 5°C	W2	W4	W4	W6	W5	W8																																																																																																																																																																																																															
-4°C ≤ TO < 0°C	W2	W3	W3	W5	W4	W6																																																																																																																																																																																																															
TO < -4°C	W1	W2	W1	W4	W2	W6																																																																																																																																																																																																															
TO abnormal	W1	WC	W1	WC	W2	WD																																																																																																																																																																																																															

Item	Operation flow and applicable data, etc.																																																																																																					
8-4. Outdoor unit control	<p>5-2) Hot water supply and heating fan control</p> <p>1) The TE sensor, TO sensor and operation frequency control the outdoor fan. (The minimum W1 to the maximum are controlled according to the table below.)</p> <p>2) For 3 minutes after the start, the maximum fan tap for each zone that is shown in the following table is fixed. After that, the fan is controlled according to the TE sensor temperature.</p> <p>3) If $TE \geq 24^{\circ}\text{C}$ continues for 5 minutes, the operation stops. No error code is displayed for this; the status is the same as the usual thermostat off. The operation restarts after 150 seconds. This intermittent running is not abnormal.</p> <p>4) If the situation in 3) frequently occurs, the possible cause is that the filter in the air inlet part of the hydro unit is dusty. Clean the filter, and restart the operation.</p> <p>TE [$^{\circ}\text{C}$]</p> <table border="1" data-bbox="363 568 730 902"> <tr> <td>24</td> <td>-2 tap/20 secs (to W1) Stop time count</td> </tr> <tr> <td>21</td> <td>-2 tap/20 secs (to W1)</td> </tr> <tr> <td>18</td> <td>-1 tap/20 secs (to W1)</td> </tr> <tr> <td>15</td> <td>Number of revolutions hold + 1 tap/20 secs (Up to the maximum tap for each zone)</td> </tr> </table> <p>For 802H-E</p> <table border="1" data-bbox="328 969 1203 1223"> <thead> <tr> <th rowspan="2">Temperature range</th> <th>Less than 20 Hz</th> <th>20 Hz or more to less than 45 Hz</th> <th>45 Hz or more</th> </tr> <tr> <th>Maximum</th> <th>Maximum</th> <th>Maximum</th> </tr> </thead> <tbody> <tr> <td>$10^{\circ}\text{C} \leq \text{TO}$</td> <td>W7</td> <td>W8</td> <td>W9</td> </tr> <tr> <td>$5^{\circ}\text{C} \leq \text{TO} < 10^{\circ}\text{C}$</td> <td>W9</td> <td>WB</td> <td>WD</td> </tr> <tr> <td>$-3^{\circ}\text{C} \leq \text{TO} < 5^{\circ}\text{C}$</td> <td>WD</td> <td>WD</td> <td>WE</td> </tr> <tr> <td>$-10^{\circ}\text{C} \leq \text{TO} < -3^{\circ}\text{C}$</td> <td>WE</td> <td>WE</td> <td>WE</td> </tr> <tr> <td>$\text{TO} < -10^{\circ}\text{C}$</td> <td>WF</td> <td>WF</td> <td>WF</td> </tr> <tr> <td>TO abnormal</td> <td>WF</td> <td>WF</td> <td>WF</td> </tr> </tbody> </table> <p>For 1102H-E</p> <table border="1" data-bbox="328 1290 1203 1543"> <thead> <tr> <th rowspan="2">Temperature range</th> <th>Less than 20 Hz</th> <th>20 Hz or more to less than 45 Hz</th> <th>45 Hz or more</th> </tr> <tr> <th>Maximum</th> <th>Maximum</th> <th>Maximum</th> </tr> </thead> <tbody> <tr> <td>$10^{\circ}\text{C} \leq \text{TO}$</td> <td>W7</td> <td>W8</td> <td>W9</td> </tr> <tr> <td>$5^{\circ}\text{C} \leq \text{TO} < 10^{\circ}\text{C}$</td> <td>W9</td> <td>WA</td> <td>WA</td> </tr> <tr> <td>$-3^{\circ}\text{C} \leq \text{TO} < 5^{\circ}\text{C}$</td> <td>WA</td> <td>WA</td> <td>WB</td> </tr> <tr> <td>$-10^{\circ}\text{C} \leq \text{TO} < -3^{\circ}\text{C}$</td> <td>WB</td> <td>WB</td> <td>WB</td> </tr> <tr> <td>$\text{TO} < -10^{\circ}\text{C}$</td> <td>WD</td> <td>WD</td> <td>WD</td> </tr> <tr> <td>TO abnormal</td> <td>WD</td> <td>WD</td> <td>WD</td> </tr> </tbody> </table> <p>For 1402H-E</p> <table border="1" data-bbox="328 1610 1203 1863"> <thead> <tr> <th rowspan="2">Temperature range</th> <th>Less than 20 Hz</th> <th>20 Hz or more to less than 45 Hz</th> <th>45 Hz or more</th> </tr> <tr> <th>Maximum</th> <th>Maximum</th> <th>Maximum</th> </tr> </thead> <tbody> <tr> <td>$10^{\circ}\text{C} \leq \text{TO}$</td> <td>W7</td> <td>W8</td> <td>W9</td> </tr> <tr> <td>$5^{\circ}\text{C} \leq \text{TO} < 10^{\circ}\text{C}$</td> <td>W9</td> <td>WA</td> <td>WB</td> </tr> <tr> <td>$-3^{\circ}\text{C} \leq \text{TO} < 5^{\circ}\text{C}$</td> <td>WB</td> <td>WB</td> <td>WC</td> </tr> <tr> <td>$-10^{\circ}\text{C} \leq \text{TO} < -3^{\circ}\text{C}$</td> <td>WC</td> <td>WC</td> <td>WC</td> </tr> <tr> <td>$\text{TO} < -10^{\circ}\text{C}$</td> <td>WD</td> <td>WD</td> <td>WD</td> </tr> <tr> <td>TO abnormal</td> <td>WD</td> <td>WD</td> <td>WD</td> </tr> </tbody> </table>	24	-2 tap/20 secs (to W1) Stop time count	21	-2 tap/20 secs (to W1)	18	-1 tap/20 secs (to W1)	15	Number of revolutions hold + 1 tap/20 secs (Up to the maximum tap for each zone)	Temperature range	Less than 20 Hz	20 Hz or more to less than 45 Hz	45 Hz or more	Maximum	Maximum	Maximum	$10^{\circ}\text{C} \leq \text{TO}$	W7	W8	W9	$5^{\circ}\text{C} \leq \text{TO} < 10^{\circ}\text{C}$	W9	WB	WD	$-3^{\circ}\text{C} \leq \text{TO} < 5^{\circ}\text{C}$	WD	WD	WE	$-10^{\circ}\text{C} \leq \text{TO} < -3^{\circ}\text{C}$	WE	WE	WE	$\text{TO} < -10^{\circ}\text{C}$	WF	WF	WF	TO abnormal	WF	WF	WF	Temperature range	Less than 20 Hz	20 Hz or more to less than 45 Hz	45 Hz or more	Maximum	Maximum	Maximum	$10^{\circ}\text{C} \leq \text{TO}$	W7	W8	W9	$5^{\circ}\text{C} \leq \text{TO} < 10^{\circ}\text{C}$	W9	WA	WA	$-3^{\circ}\text{C} \leq \text{TO} < 5^{\circ}\text{C}$	WA	WA	WB	$-10^{\circ}\text{C} \leq \text{TO} < -3^{\circ}\text{C}$	WB	WB	WB	$\text{TO} < -10^{\circ}\text{C}$	WD	WD	WD	TO abnormal	WD	WD	WD	Temperature range	Less than 20 Hz	20 Hz or more to less than 45 Hz	45 Hz or more	Maximum	Maximum	Maximum	$10^{\circ}\text{C} \leq \text{TO}$	W7	W8	W9	$5^{\circ}\text{C} \leq \text{TO} < 10^{\circ}\text{C}$	W9	WA	WB	$-3^{\circ}\text{C} \leq \text{TO} < 5^{\circ}\text{C}$	WB	WB	WC	$-10^{\circ}\text{C} \leq \text{TO} < -3^{\circ}\text{C}$	WC	WC	WC	$\text{TO} < -10^{\circ}\text{C}$	WD	WD	WD	TO abnormal	WD	WD	WD
24	-2 tap/20 secs (to W1) Stop time count																																																																																																					
21	-2 tap/20 secs (to W1)																																																																																																					
18	-1 tap/20 secs (to W1)																																																																																																					
15	Number of revolutions hold + 1 tap/20 secs (Up to the maximum tap for each zone)																																																																																																					
Temperature range	Less than 20 Hz	20 Hz or more to less than 45 Hz	45 Hz or more																																																																																																			
	Maximum	Maximum	Maximum																																																																																																			
$10^{\circ}\text{C} \leq \text{TO}$	W7	W8	W9																																																																																																			
$5^{\circ}\text{C} \leq \text{TO} < 10^{\circ}\text{C}$	W9	WB	WD																																																																																																			
$-3^{\circ}\text{C} \leq \text{TO} < 5^{\circ}\text{C}$	WD	WD	WE																																																																																																			
$-10^{\circ}\text{C} \leq \text{TO} < -3^{\circ}\text{C}$	WE	WE	WE																																																																																																			
$\text{TO} < -10^{\circ}\text{C}$	WF	WF	WF																																																																																																			
TO abnormal	WF	WF	WF																																																																																																			
Temperature range	Less than 20 Hz	20 Hz or more to less than 45 Hz	45 Hz or more																																																																																																			
	Maximum	Maximum	Maximum																																																																																																			
$10^{\circ}\text{C} \leq \text{TO}$	W7	W8	W9																																																																																																			
$5^{\circ}\text{C} \leq \text{TO} < 10^{\circ}\text{C}$	W9	WA	WA																																																																																																			
$-3^{\circ}\text{C} \leq \text{TO} < 5^{\circ}\text{C}$	WA	WA	WB																																																																																																			
$-10^{\circ}\text{C} \leq \text{TO} < -3^{\circ}\text{C}$	WB	WB	WB																																																																																																			
$\text{TO} < -10^{\circ}\text{C}$	WD	WD	WD																																																																																																			
TO abnormal	WD	WD	WD																																																																																																			
Temperature range	Less than 20 Hz	20 Hz or more to less than 45 Hz	45 Hz or more																																																																																																			
	Maximum	Maximum	Maximum																																																																																																			
$10^{\circ}\text{C} \leq \text{TO}$	W7	W8	W9																																																																																																			
$5^{\circ}\text{C} \leq \text{TO} < 10^{\circ}\text{C}$	W9	WA	WB																																																																																																			
$-3^{\circ}\text{C} \leq \text{TO} < 5^{\circ}\text{C}$	WB	WB	WC																																																																																																			
$-10^{\circ}\text{C} \leq \text{TO} < -3^{\circ}\text{C}$	WC	WC	WC																																																																																																			
$\text{TO} < -10^{\circ}\text{C}$	WD	WD	WD																																																																																																			
TO abnormal	WD	WD	WD																																																																																																			

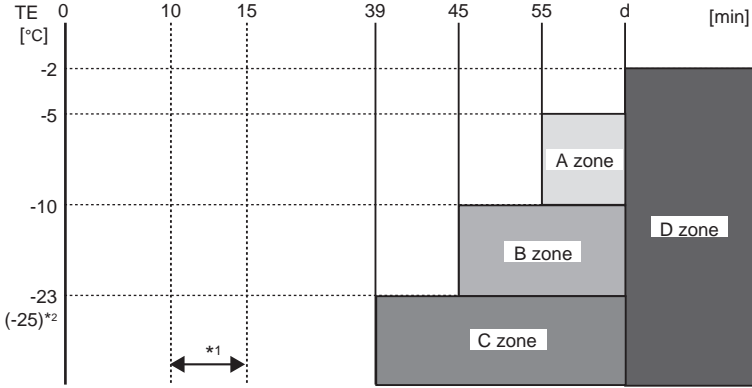
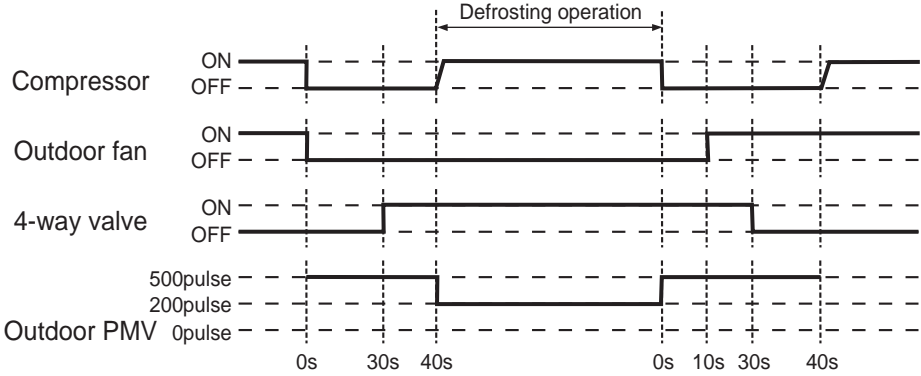
Item	Operation flow and applicable data, etc.																																								
8-4. Outdoor unit control	<p data-bbox="325 293 1455 367">6) Defrosting control This control defrosts the outdoor heat exchanger. The temperature sensor (TE sensor) of the outdoor heat exchanger determines frost formation, and then defrosting is performed in the 4-way valve reverse defrosting method.</p> <ol data-bbox="347 389 1455 568" style="list-style-type: none"> 1) During a heating operation, defrosting is performed when the TE sensor meets any of the conditions in A through D zones. 2) During defrosting, when TE sensor maintains 12°C or higher for 3 seconds or 7°C ≤ TE < 12°C for a minute, the defrosting ends. Also, when defrosting continues for 10 minutes even if the TE sensor temperature is below 7°C, the defrosting ends. 3) After the defrosting, stop the compressor for approx. 40 seconds before starting a heating operation. 4) Switching the jumper "J805" and "J806" of the outdoor control board can change the time of d above mentioned. (Factory setting: 150 minutes) <p data-bbox="339 589 600 613">Heating operation starts</p>  <p data-bbox="1098 853 1445 999">*1 In 10 to 15 minutes after the heating operation starts, the lowest value of TE is recorded as TEO, and the lowest temperature of To as ToO. *2 Inside brackets: For 802H-E</p> <table border="1" data-bbox="328 1043 1445 1211"> <thead> <tr> <th colspan="2">To Normal</th> </tr> </thead> <tbody> <tr> <td>A Zone</td> <td>Maintain " (TEO - TE) - (ToO - To) ≥ 3°C" for 20 secs</td> </tr> <tr> <td>B Zone</td> <td>Maintain " (TEO - TE) - (ToO - To) ≥ 2°C" for 20 secs</td> </tr> <tr> <td>C Zone</td> <td>Maintain " TE ≤ -23°C" for 20 secs (1102, 1402H-E) Maintain " TE < -25°C" for 20 secs (802H-E)</td> </tr> <tr> <td>D Zone</td> <td>Accumulate compressor operation status of TE < -2°C for 150 mins</td> </tr> </tbody> </table> <table border="1" data-bbox="328 1232 1445 1400"> <thead> <tr> <th colspan="2">To Normal</th> </tr> </thead> <tbody> <tr> <td>A Zone</td> <td>Maintain " TEO - TE ≥ 3°C" for 20 secs</td> </tr> <tr> <td>B Zone</td> <td>Maintain " TEO - TE ≥ 2°C" for 20 secs</td> </tr> <tr> <td>C Zone</td> <td>Maintain " TE ≤ -23°C" for 20 secs (1102, 1402H-E) Maintain " TE < -25°C" for 20 secs (802H-E)</td> </tr> <tr> <td>D Zone</td> <td>Accumulate compressor operation status of TE < -2°C for 150 mins</td> </tr> </tbody> </table> <p data-bbox="325 1435 491 1458">Jumper switching</p> <p data-bbox="916 1435 1150 1458">O: Short circuit ×: Open</p> <table border="1" data-bbox="328 1469 1166 1619"> <thead> <tr> <th>J805</th> <th>J806</th> <th>d (1102,1402H-E)</th> <th>d (802H-E)</th> </tr> </thead> <tbody> <tr> <td>O</td> <td>O</td> <td>150 mins (Factory setting)</td> <td>150 mins (Factory setting)</td> </tr> <tr> <td>O</td> <td>×</td> <td>90 mins</td> <td>90 mins</td> </tr> <tr> <td>×</td> <td>O</td> <td>60 mins</td> <td>60 mins</td> </tr> <tr> <td>×</td> <td>×</td> <td>30 mins</td> <td>30 mins</td> </tr> </tbody> </table> 	To Normal		A Zone	Maintain " (TEO - TE) - (ToO - To) ≥ 3°C" for 20 secs	B Zone	Maintain " (TEO - TE) - (ToO - To) ≥ 2°C" for 20 secs	C Zone	Maintain " TE ≤ -23°C" for 20 secs (1102, 1402H-E) Maintain " TE < -25°C" for 20 secs (802H-E)	D Zone	Accumulate compressor operation status of TE < -2°C for 150 mins	To Normal		A Zone	Maintain " TEO - TE ≥ 3°C" for 20 secs	B Zone	Maintain " TEO - TE ≥ 2°C" for 20 secs	C Zone	Maintain " TE ≤ -23°C" for 20 secs (1102, 1402H-E) Maintain " TE < -25°C" for 20 secs (802H-E)	D Zone	Accumulate compressor operation status of TE < -2°C for 150 mins	J805	J806	d (1102,1402H-E)	d (802H-E)	O	O	150 mins (Factory setting)	150 mins (Factory setting)	O	×	90 mins	90 mins	×	O	60 mins	60 mins	×	×	30 mins	30 mins
To Normal																																									
A Zone	Maintain " (TEO - TE) - (ToO - To) ≥ 3°C" for 20 secs																																								
B Zone	Maintain " (TEO - TE) - (ToO - To) ≥ 2°C" for 20 secs																																								
C Zone	Maintain " TE ≤ -23°C" for 20 secs (1102, 1402H-E) Maintain " TE < -25°C" for 20 secs (802H-E)																																								
D Zone	Accumulate compressor operation status of TE < -2°C for 150 mins																																								
To Normal																																									
A Zone	Maintain " TEO - TE ≥ 3°C" for 20 secs																																								
B Zone	Maintain " TEO - TE ≥ 2°C" for 20 secs																																								
C Zone	Maintain " TE ≤ -23°C" for 20 secs (1102, 1402H-E) Maintain " TE < -25°C" for 20 secs (802H-E)																																								
D Zone	Accumulate compressor operation status of TE < -2°C for 150 mins																																								
J805	J806	d (1102,1402H-E)	d (802H-E)																																						
O	O	150 mins (Factory setting)	150 mins (Factory setting)																																						
O	×	90 mins	90 mins																																						
×	O	60 mins	60 mins																																						
×	×	30 mins	30 mins																																						

Item	Operation flow and applicable data, etc.
8-4. Outdoor unit control	<p>7) Winding heating control</p> <ol style="list-style-type: none"> 1) This control energizes the inactive compressor instead of the case heater to warm the compressor. The purpose is to prevent the refrigerant from staying inside the compressor. 2) After the unit is installed, failure to perform energization for the given time period may cause the compressor to fail. Also, when starting an operation long after the power left off, first energize the compressor before starting the operation in the same way as a trial run. 3) Energization is determined by the TD sensor and TO sensor. If the TO sensor fails, the TE sensor automatically takes over the operation. Determine whether the TO sensor fails by checking the LED outside. 4) If TD is 30°C or higher, the energization stops. <div style="text-align: center;"> </div> <p>Notes During winding energization, energizing noise may be heard, but this is not abnormal.</p>
	<p>8) Short circuit operation prevention control</p> <ol style="list-style-type: none"> 1) In 10 minutes after the operation start, the compressor may not stop for protection. This status is not abnormal. (The operation duration time of the compressor varies depending on a operation status.) 2) If the operation stops with the remote controller, the operation does not continue.
	<p>9) Over current protection control</p> <ol style="list-style-type: none"> 1) A detection of abnormal current with the over current protection control stops the compressor. 2) Set the abnormality detection counter to 1, and restarts the compressor after 150 seconds. 3) When the stop by over current protection control counts 8 times, error code is displayed and the compressor does not restart. (Remote controller error code display: HO1)

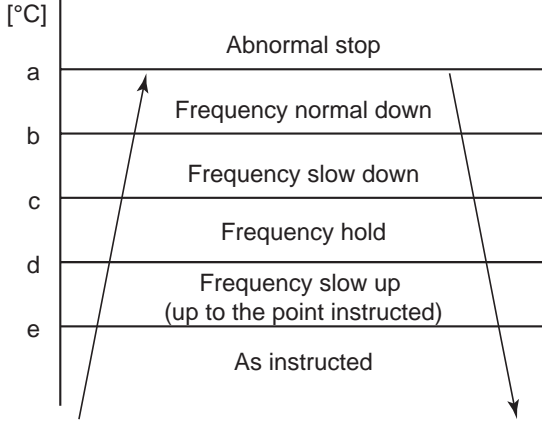
Item	Operation flow and applicable data, etc.																																						
8-4. Outdoor unit control	<p>10) High temperature release control</p> <ol style="list-style-type: none"> 1) To prevent excessive hi pressure rise, operation frequency is controlled by the TL sensor when cooling and by TWO sensor when heating. 2) If the TL sensor when cooling or the TWO sensor when heating detects an abnormal stop zone temperature, the compressor stops and the abnormality detection counter increments. 3) When the compressor stops in 2), the operation restarts when the temperature returns to the usual operation zone ("e" or below) after 150 seconds. 4) When the compressor stops in 2), the abnormality detection counter is cleared when the operation continues for 10 minutes. If the counter counts 10 times, error code is displayed and the compressor does not restart. 5) For details about an check code displayed, see the check code list. <p>Heating TC Cooling TL</p>  <table border="1" data-bbox="328 1077 1015 1312"> <thead> <tr> <th rowspan="3"></th> <th colspan="2">802H-E</th> <th colspan="2">1102H-E, 1402H-E</th> </tr> <tr> <th>Heating</th> <th>Cooling</th> <th>Heating</th> <th>Cooling</th> </tr> <tr> <th>TC (TWO+2)</th> <th>TL</th> <th>TC (TWO+2)</th> <th>TL</th> </tr> </thead> <tbody> <tr> <td>a</td> <td>61°C</td> <td>63°C</td> <td>62°C</td> <td>63°C</td> </tr> <tr> <td>b</td> <td>56°C</td> <td>62°C</td> <td>57°C</td> <td>62°C</td> </tr> <tr> <td>c</td> <td>54°C</td> <td>60°C</td> <td>55°C</td> <td>60°C</td> </tr> <tr> <td>d</td> <td>52°C</td> <td>58°C</td> <td>53°C</td> <td>58°C</td> </tr> <tr> <td>e</td> <td>48°C</td> <td>54°C</td> <td>49°C</td> <td>54°C</td> </tr> </tbody> </table>		802H-E		1102H-E, 1402H-E		Heating	Cooling	Heating	Cooling	TC (TWO+2)	TL	TC (TWO+2)	TL	a	61°C	63°C	62°C	63°C	b	56°C	62°C	57°C	62°C	c	54°C	60°C	55°C	60°C	d	52°C	58°C	53°C	58°C	e	48°C	54°C	49°C	54°C
	802H-E		1102H-E, 1402H-E																																				
	Heating		Cooling	Heating	Cooling																																		
	TC (TWO+2)	TL	TC (TWO+2)	TL																																			
a	61°C	63°C	62°C	63°C																																			
b	56°C	62°C	57°C	62°C																																			
c	54°C	60°C	55°C	60°C																																			
d	52°C	58°C	53°C	58°C																																			
e	48°C	54°C	49°C	54°C																																			

9 Method of Defect Diagnosis

In order to diagnose the defective part of the heat pump system, first understand the symptom of the defect.

- (1) Check the operation status. (It does not move, or it moves but stops, etc.)
- (2) Flashing display on the display part of the hydro unit.
- (3) Check the “check code” by the remote control.

Please refer to the following procedure of defect diagnosis for the identification.

No.	Procedure of defect diagnosis		Remark
9-1	Matters to be confirmed first	9-1-1 Check the power supply voltage 9-1-2 Check for any miswiring of the connection cables between the hydro unit and the outdoor unit 9-1-3 About the installation of the temperature sensor	Check the power supply for the heat pump hot water heater, the crossover between the hydro unit and the outdoor unit, and the installation of temperature sensors.
9-2	Non-defective operation (program operation)		Non-defective program operations for the protection of the heat pump unit.
9-3	Outline of the determination diagram	9-3-1 Procedure of defect diagnosis 9-3-2 How to determine from the check code display on the remote controller 9-3-3 How to cancel a check code on the remote controller 9-3-4 How to diagnose by error code	With reference to the "check code", roughly identify the defect from the defect diagnosis for the heat pump hot water heater and determine the defective part from individual symptoms.
9-4	Diagnosis flow chart for each error code	9-4-1 Hydro unit failure detection 9-4-2 Outdoor unit failure detection 9-4-3 Temperature sensor, temperature-resistance characteristic table	
9-5	Operation check by PC board	9-5-1 Operation check mode	The operation check mode allows to determine good or not by checking the operation of the 4-way valve, 2-way valve and pulse motor valve.
9-6	Brief method for checking the key components	9-6-1 Hydro unit 9-6-2 Outdoor unit	How to determine the presence of any defect particularly in functional parts.

9-1. Matters to be confirmed first

9-1-1. Check the power supply voltage

Check that the power supply voltage is AC230 V±23 V. If the power supply voltage is not in this range, it may not operate normally.

9-1-2. Check for any miswiring of the connection cables between the hydro unit and the outdoor unit

The hydro unit and the outdoor unit are connected with three connection cables. Make sure the interconnecting connections between the hydro unit and the outdoor unit terminal blocks are connected to the correct terminal numbers. If not connected correctly, the heat pump system does not operate. However, a miswiring would not cause damage to the equipment.

9-1-3. About the installation of the temperature sensor

If each sensor is removed due to the replacement of the water heat exchange or inverter board, or the replacement of the refrigeration cycle parts, make sure to put the sensor back to the position where it was before.

- Each sensor position has a marking. Make sure to put it back to the exact position.
- Make sure to install it with a sensor holder so that the temperature sensing part of the sensor and the straight part of the copper piping are attached with each other tightly.
- If the installation of the sensor is incomplete or the installed position is wrong, it will not perform a normal control operation and may cause a defect such as a malfunction of the equipment or an occurrence of an abnormal sound, etc.

9-2. Non-defective operation (program operation) ... No fault code display appears.

In order to control the heat pump unit, there are the following operations as the built-in program operations in the microcomputer. If a claim occurs about the operation, please confirm whether it falls under any of the contents in the following table.

If it does, please understand that the symptom is not a defect of the equipment, and it is an operation necessary for the control and maintenance of the heat pump unit.

Table 9-2-1 Non-defective operation

No.	Operation of the heat pump system	Explanation
1	The compressor sometimes does not operate even within the range of compressor "ON".	The compressor does not operate during the operation of the compressor reboot timer (3 min). Even after the power activation, the compressor reboot timer continues to be active.
2	During the hot water supply or heating operation, without reaching the set temperature, the compressor operation frequency stays at a frequency of less than the maximum Hz or lowers down.	It may be caused by the high temperature release control (release protection control by the temperature of the water heat exchanger) or the current release control.
3	The "Stop" operation on the remote control will not stop the circulating pump. (The same for hot water supply, heating and cooling)	In order to deal with the temperature increase in the heat exchanger after stopping, the operation continues for 1 min after the compressor is stopped.
4	"ON" on the remote control will not operate the compressor. (It will not operate even after the reboot delay timer elapsed)	When the outdoor temperature (TO sensor detection temperature) is -20°C or lower, the heat pump will not operate in order to protect the compressor, and the heater will operate instead.
5	When the power is turned on, it starts operation without operating the remote control.	<ul style="list-style-type: none"> • The auto restart operation may be working. • The antifreeze operation may be working. • If the TWI, TWO or THO sensor detects a temperature below 4°C, the operation changes from circulating pump --->> circulating pump + heater.)

9-3. Outline of the determination diagram

The first determination of whether a defective part is in the hydro unit or the outdoor unit can be performed by the following method.

9-3-1. Procedure of defect diagnosis

In the case of a defect, please apply the following procedure in order to find the defective part.

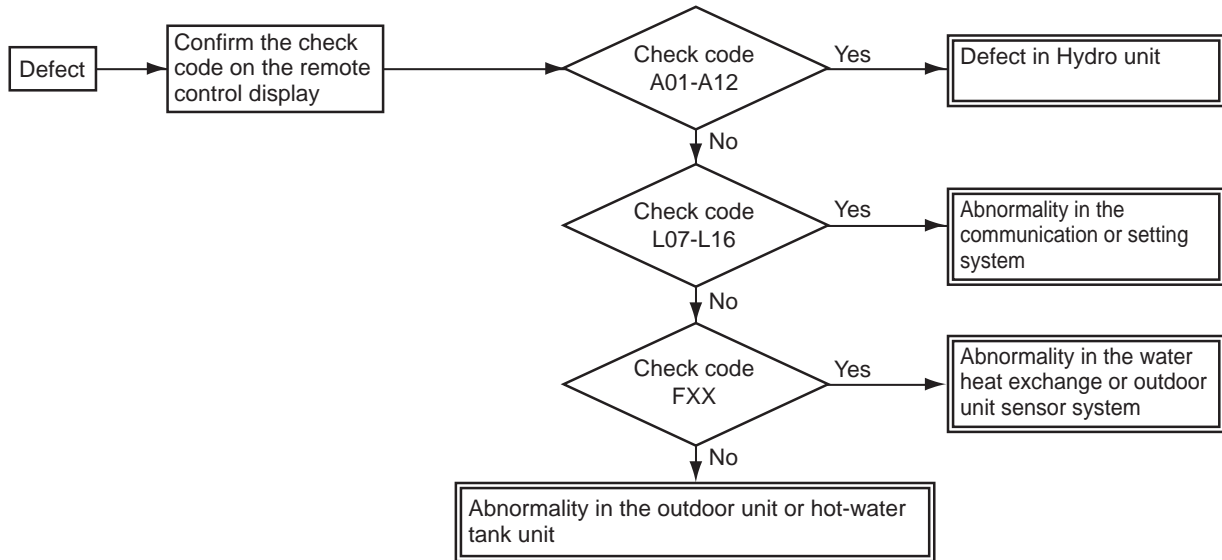

9-3-2. How to determine from the check code on the remote control

If the defect is limited by the check code displayed on the remote control, please repair the defect based on the table on the next page.

The check codes are separated into two groups: software and hardware errors.

Since a hardware error cannot be cancelled without a part replacement etc., please perform a repair.

If its abnormality is determined, the abnormality is noticed by indicating the check code on the remote control check code display part while letting off a buzzer.

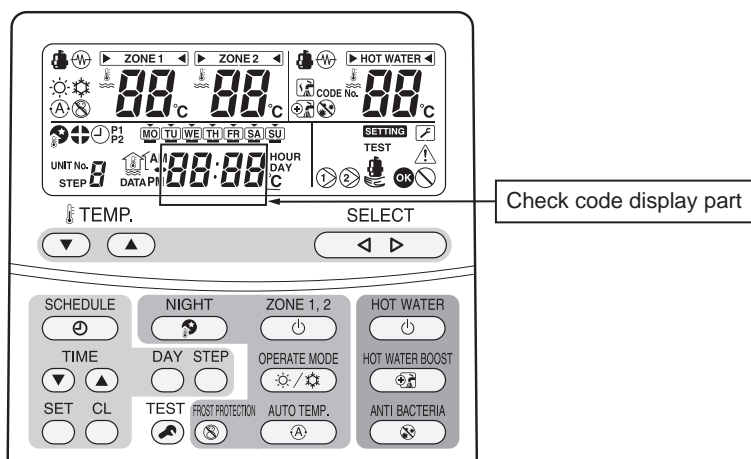

9-3-3. How to cancel a check code on the remote controller

- (1) Press or button (on the operation side) to clear the check code.
- (2) Press to stop a buzzer for an abnormality only.

Although the above procedure cancels the check code, the hardware error will be displayed again until the hardware repair is completed.

9-3-4. How to diagnose by error code

Defect mode detected by the water heat exchange

○ ... Possible
 × Not possible

Check code	Diagnostic functional operation			Determination and action	Number of abnormalities for confirmation	Detailed item
	Operational cause	Backup present	Automatic reset			
A01	Pump or flowing quantity error 1) Detected by TC sensor TC ≥ 63°C is detected in the heating or hot water supply heat pump operation (except for defrosting).	×	×	1. Almost no or little water flow. • Not enough vent air • Dirt clogging in the water piping system. • The water piping is too long. • Installation of buffer tank and secondary pump	4	74
	2) Detected by flow switch abnormality When no signal of the flow switch is showing 2 min after the built-in pump operation started.					
	3) Detection of chattering abnormality in the flow switch input Chattering detection: Detects input changes (OFF⇔ON) 4 times within 10 seconds during operation.					
	4) Disconnection of the flow switch connector When the stopped built-in pump starts its operation, the flow switch status is detecting "water flow".					
A02	Temperature increase error (heating) When one of the TWI, TWO and THO sensors exceeds 70°C.	Heating ○ Hot water ×	○	1. Check the water inlet, water outlet and heater outlet (TWI, TWO, THO) sensors. 2. Defect of the backup heater (defect automatic reset thermostat).	1	75
A03	Temperature increase error (hot water supply) When the TTW sensor exceeds 85°C.	Heating ○ Hot water ×	○	1. Check the hot water cylinder sensor (TTW). 2. Check the hot water cylinder thermal cut-out.	1	76
A04	Antifreeze operation 1) TWO > 20°C condition: 2 × TC + TWO < -12°C is detected. 2) TWO ≤ 20°C condition: TC + TWO < 4°C is detected. 3) TWI ≤ 10°C is detected during defrosting.	○	×	1. Almost no or little water flow. • Dirt clogging in the water piping system. • The water piping is too long. 2. Check the heater power circuit. • Power supply voltage, breaker, power supply connection 3. Set the presence of the backup heater. 4. Check the water inlet, water outlet and heat exchange (TWI, TWO, TC) sensors.	Heating2 Hot water2 Cooling4	77
A05	Piping antifreeze operation Activating the heater under the condition of TWO < 4 or TWI < 4 or THO < 4 does not achieve TWO, TWI, THO ≥ 5°C after 30 min elapsed.	○	○	1. Check the heater power circuit. • Power supply voltage, breaker, power supply connection 2. Check the water inlet, water outlet and heater outlet sensors (TWI, TWO, THO). 3. Disconnection of the backup heater.	1	78

Check code	Diagnostic functional operation			Determination and action	Number of abnormalities for confirmation	Detailed item
	Operational cause	Backup present	Automatic reset			
A07	Pressure switch operation The pressure switch operates for 300 sec continuously during the heat pump operation.	○	×	1. Almost no or little water flow. 2. Defect of the flow switch. 3. On-load operation under the above conditions. 4. Defect in the pressure switch.	1	79
A08	Low pressure sensor operation error The low pressure sensor detected 0.2 MPa or less.	○	×	1. Almost no or little water flow. 2. Defect of the flow switch. 3. On-load cooling or prolonged defrosting (a lot of frost formation) under the above conditions.	8	80
				4. Defect in the low pressure sensor.	2	
A09	Overheat protection operation When the thermostat of the backup heater activates during the operation of the heat pump or backup heater. When the thermostat operation is activated while it has been stopped.	○	×	1. No water (heating without water) or no water flow. 2. Defect of the flow switch.	2	81
				3. Defect of the backup heater (poor automatic reset thermostat).	1	
A11	Operation of the release protection When the TWO release counts to 10.	Heating Cooling × Hot water ○	×	1. Almost no water flow. 2. Defect of the flow switch. 3. Check the water outlet temperature sensor (TWO).	10	82
A12	Heating, hot water heater The antifreeze control is detected under the condition of TWI<20°C while TWI>15°C, TTW>20°C is not detected after the heater backup.	○	○	1. Activated by a large load of heating or hot water supply. 2. Check the heater power circuit (backup or hot water cylinder heater). • Power supply voltage, breaker, power supply connection	1	83
E03	Regular communication error between hydro unit and remote controller When there is no regular communication from the remote control for 3 min, or when no remote control is equipped.	×	○	1. Check remote control connection. 2. Defect in the remote control.	1	—
E04	Regular communication error between hydro unit and outdoor unit The serial signal cannot be received from outdoor.	○	○	1. Check the serial circuit. • Miswiring of the crossover between the water heat exchanger and the outdoor unit	1	84
F03	TC sensor error Open or short circuit in the heat exchange temperature sensor.	○	○	1. Check the resistance value and connection of the heat exchange temperature sensor (TC).	1	85
F10	TWI sensor error Open or short circuit in the water inlet temperature sensor.	○	○	1. Check the resistance value and connection of the water inlet temperature sensor (TWI).	1	86
F11	TWO sensor error Open or short circuit in the water outlet temperature sensor.	×	○	1. Check the resistance value and connection of the water outlet temperature sensor (TWO).	1	87
F14	TTW sensor error Open or short circuit in the hot water cylinder sensor.	×	○	1. Check the resistance value and connection of the hot water cylinder sensor (TTW).	1	87

Check code	Diagnostic functional operation			Determination and action	Number of abnormalities for confirmation	Detailed item
	Operational cause	Backup present	Automatic reset			
F17	TFI sensor error Open or short circuit in the floor temperature sensor.	×	○	1. Check the resistance value and disconnection of the floor-inlet temperature sensor (TFI).	1	87
F18	THO sensor error Open or short circuit in the heater outlet temperature sensor.	×	○	1. Check the resistance value and disconnection of the heater outlet temperature sensor (THO).	1	88
F19	Detection of THO disconnection error When TWO-THO>15K is detected and 30 sec elapsed.	×	×	1. Check for any disconnection of the heater outlet temperature sensor (THO).	1	88
F20	TFI sensor error When TWO-TFI>30K is detected and TFI<TWI-5K is detected.	×	×	1. Check any disconnection of the floor-inlet temperature sensor (TFI).	1	89
F23	Low pressure sensor error When PS<0.07 MPa is detected for 2 sec or more.	○	○	1. Check for any disconnection (body or connection wiring) of the low pressure sensor. 2. Check the resistance value of the low pressure sensor.	1	89
F29	EEROM error Inconsistency is detected once without verify ACK after writing to EEPROM.	×	×	1. Replace the water heat exchange control board.	1	90
F30	Extended IC error When the extended IC is abnormal.	×	×	1. Replace the water heat exchange control board.	1	90
L07	Communication error Individual hydro units have a group line.	×	×	1. Replace the water heat exchange control board.	1	90
L09	Communication error The capability of the hydro unit has not been set.	×	×	1. Check the setting of the FC01 capability specifications. HWS-802xx-E = 0012 HWS-1402xx-E = 0017	1	90
L16	Setting error When ZONE1 has not been set, while ZONE2 has been set.	×	×	1. Check the body DP-SW12_2,3.	1	90

Defect mode detected by the outdoor unit

○ ... Possible
× ... Not possible

Check code	Diagnostic functional operation			Determination and action	Number of abnormalities for confirmation	Detailed item
	Operational cause	Backup present	Automatic reset			
F04	TD sensor error Open or short circuit in the discharge temperature sensor.	○	×	1. Check the resistance value and connection of the discharge sensor (TD).	1	85 99
F06	TE sensor error Open or short circuit in the heat exchange temperature sensor.	○	×	1. Check the resistance value and connection of the heat exchange temperature sensor (TE).	1	85 99
F07	TL sensor error Open or short circuit in the heat exchange temperature sensor.	○	×	1. Check the resistance value and connection of the heat exchange temperature sensor (TL).	1	86 99
F08	TO sensor error Open or short circuit in the outdoor temperature sensor.	○	×	1. Check the resistance value and connection of the outdoor temperature sensor (TO).	1	86 99
F12	TS sensor error Open or short circuit in the suction temperature sensor.	○	×	1. Check the resistance value and connection of the suction temperature sensor (TS).	1	100
F13	TH sensor error Open or short circuit in the heat-sink temperature sensor.	○	×	1. Check the resistance value and connection of the heat-sink temperature sensor (TH).	1	100
F15	TE, TS sensors error Open or short circuit in the temperature sensors.	○	×	1. Check for any wrong installation of the heat exchange temperature sensor (TE) and the suction temperature sensor (TS).	1	100
F31	EEPROM error	○	×		1	100
H01	Compressor breakdown 1 When the operation frequency lowers due to the current release 40 sec or later after the compressor activation and it stops by underrunning the minimum frequency. 2 When the operation frequency lowers due to the current limit control and it stops by underrunning the minimum frequency. 3 When an excess current is detected 0.8 sec or later after the compressor activation.	○	×	1. Check the power supply voltage (AC230 V±23 V). 2. Over-loaded condition of the refrigeration cycle. 3. Check that the service valve is fully open.	8	91
H02	Compressor lock 1 When the input current is more than zero 20 sec or later after the compressor activation and the activation has not been completed.	○	×	1. Defect of compressor (lock) – Replace the compressor. 2. Defect of compressor wiring (open phase).	8	92
H03	Defect in the current detection circuit	○	×	1. Replace the outdoor inverter control board.	8	92

Check code	Diagnostic functional operation			Determination and action	Number of abnormalities for confirmation	Detailed item
	Operational cause	Backup present	Automatic reset			
H04	Operation of case thermostat When the case thermostat exceeds 125°C.	O	×	1. Check the refrigeration cycle (gas leak). 2. Check the case thermostat and connector. 3. Check that the service valve is fully open. 4. Defect of the pulse motor valve. 5. Check for a kinked piping.	4	92
L10	Unset service PC board jumper Jumpers J800-J803 have not been cut.	O	×	1. Cut J800-J803.	1	92
L29	The communication between the outdoor PC board MUCs error No communication signal between IPDU and CDB.	O	×	1. Replace the outdoor control board.	1	93
P03	The outlet temperature error When the discharge temperature sensor (TD) exceeds 111°C.	O	×	1. Check the refrigeration cycle (gas leak). 2. Defect of the pulse motor valve. 3. Check the resistance value of the discharge temperature sensor (TD).	4	94
P04	The high pressure switch error	O	×		10	94
P05	The power supply voltage error When the power supply voltage is extremely high or low.	O	×	1. Check the power supply voltage. (AC230 V±23 V)	4	94
P07	Overheating of heat-sink error When the heat-sink exceeds 105°C.	O	×	1. Check the thread fastening and heat-sink grease between the outdoor control board and the heat-sink. 2. Check the heat-sink fan duct. 3. Check the resistance value of the heat-sink temperature sensor (TH).	4	95
P15	Detection of gas leak When the discharge temperature sensor (TD) exceeds 106°C for consecutive 10 min. When the suction temperature sensor (TS) exceeds 60°C for cooling or 40°C for heating for 10 consecutive min.	O	×	1. Check the refrigeration cycle (gas leak). 2. Check that the service valve is fully open. 3. Defect of the pulse motor valve. 4. Check for a kinked piping. 5. Check the resistance value of the discharge temperature sensor (TD) and the suction temperature sensor (TS).	4	95
P19	The 4-way valve inversion error When the heat exchange temperature sensor (TE) exceeds 30°C or the suction temperature sensor (TS) exceeds 50°C during the heat pump operation.	O	×	1. Check the operation of the 4-way valve unit or the coil characteristics. 2. Defect of the pulse motor valve. 3. Check the resistance value of the heat exchange temperature sensor (TE) and the suction temperature sensor (TS).	4	96

Check code	Diagnostic functional operation			Determination and action	Number of abnormalities for confirmation	Detailed item
	Operational cause	Backup present	Automatic reset			
P20	<p>High pressure protection operation When an abnormal stop occurs due to the high pressure release control. When the heat exchange temperature sensor (TL) detects 63°C during the cooling operation. When the water outlet sensor (TWO) detects 60°C during the heating or hot water supply operation.</p>	O	×	<p>1. Check that the service valve is fully open. 2. Defect of the pulse motor valve. 3. Check the outdoor fan system (including clogging). 4. Over-filling of refrigerant. 5. Check the resistance value of the heat exchange temperature sensor (TL) and the water outlet temperature sensor (TWO).</p>	10	97
P22	<p>Outdoor fan system error When a DC fan rotor position detection NG, element short circuit, loss of synchronization, or abnormal motor current occurs.</p>	O	×	<p>1. Check the lock status of the motor fan. 2. Check the connection of the fan motor cable connector. 3. Check the power supply voltage (AC230 V±23 V).</p>	1-4	98
P26	<p>Short circuit of the compressor driver element error When an abnormal short circuit of IGBT is detected.</p>	O	×	<p>1. P26 abnormality occurs when operating with the compressor wiring disconnected ... Check the control board. 2. No abnormality occurs when operating with the compressor wiring disconnected ... Compressor rare short.</p>	8	98
P29	<p>Compressor rotor position error The rotor position in the compressor cannot be detected.</p>	O	×	<p>1. Even if the connection lead wire of the compressor is disconnected, it stops due to an abnormality in the position detection ... Replace the inverter control board. 2. Check the wire wound resistor of the compressor. Short circuit ... Replace the compressor.</p>	8	98

Defect mode detected by the remote control

Check code	Diagnostic functional operation			Determination and action
	Operational cause	Status of air-conditioning	Condition	
Not displaying at all (cannot operate by the remote control)	No communication between hydro unit and remote controller <ul style="list-style-type: none"> The remote control wiring is not connected correctly. The hydro unit has not been turned on. 	Stop	–	Defect in the remote control power supply <ol style="list-style-type: none"> Check the remote controller wiring. Check the remote controller. Check the hydro unit power supply wiring. Check the water heat exchange control board.
E01	No communication between hydro unit and remote controller <ul style="list-style-type: none"> Disconnection of the crossover between the remote control and the base unit of the indoor unit (detected on the remote control side). 	Stop (Automatic reset)	Displayed when the abnormality is detected.	Defect in the reception of the remote control <ol style="list-style-type: none"> Check the remote control crossover. Check the remote control. Check the hydro power supply wiring. Check the water heat exchanger board.
E02	Defect in the signal transmission to the hydro unit. (Detected on the remote control side)	Stop (Automatic reset)	Displayed when the abnormality is detected.	Defect in the transmission of the remote control <ol style="list-style-type: none"> Check the transmitter circuit inside the remote control. ... Replace the remote control.
E09	Several remote control base units (Detected on the remote control side)	Stop (The handset continues)	Displayed when the abnormality is detected.	1.2 Check several base units with the remote control ... The base unit is only one, and others are handsets.

9-4. Diagnosis flow chart for each error code

9-4-1. Hydro unit failure detection

[A01] Error Pump flow determination

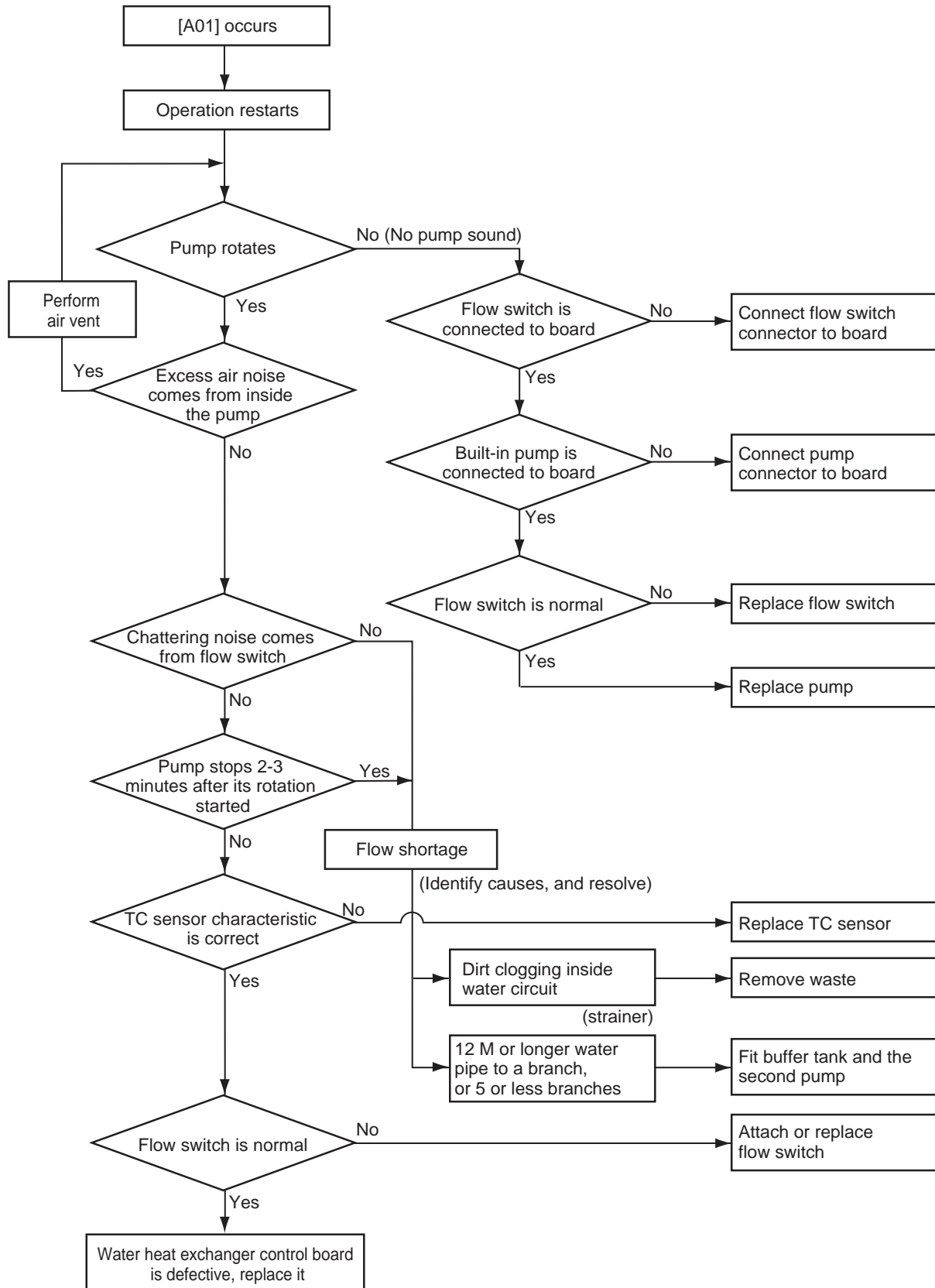

[A02] Error Temperature rise and error short circuit

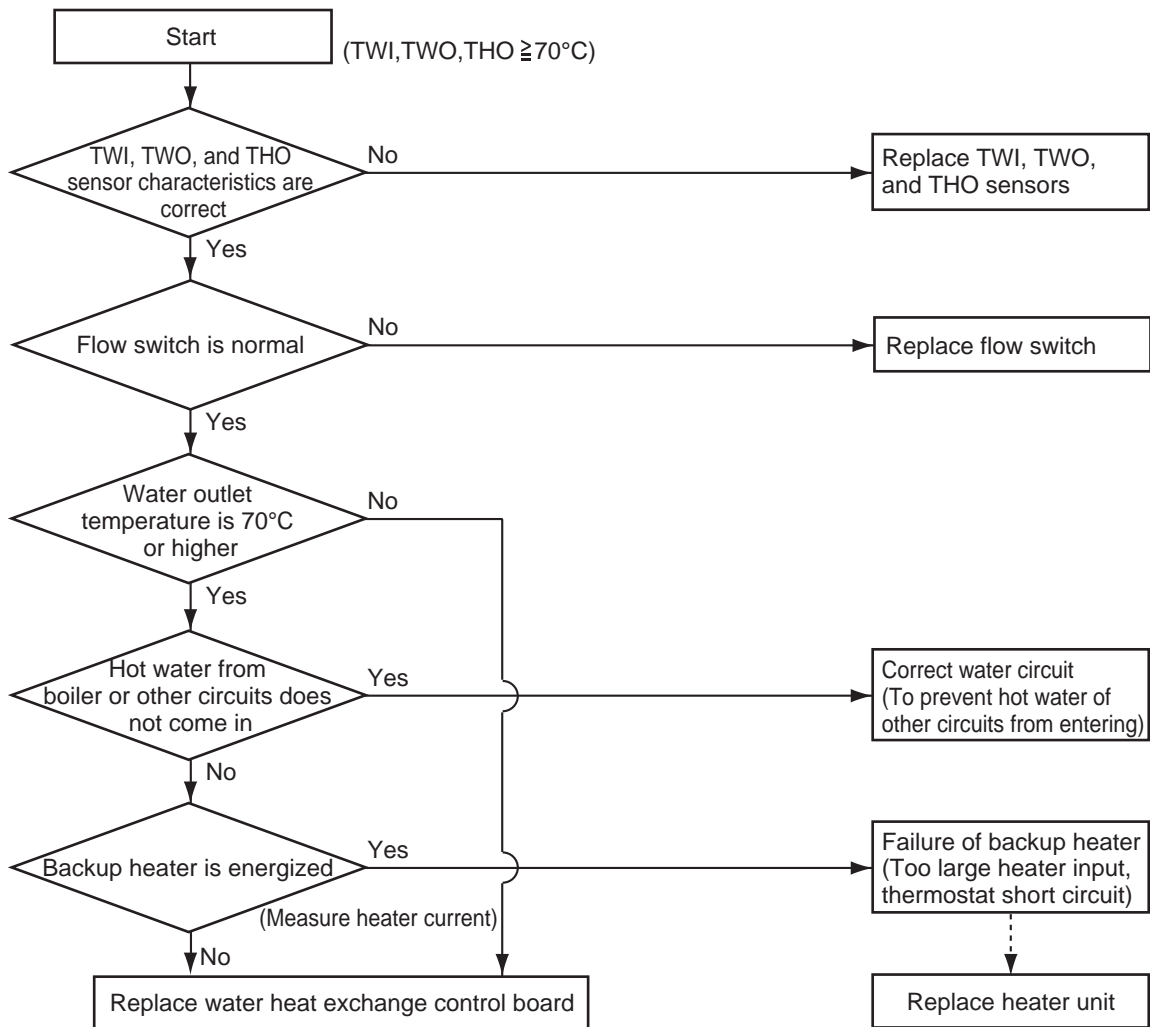

[A03] Error Temperature rise and error short circuit

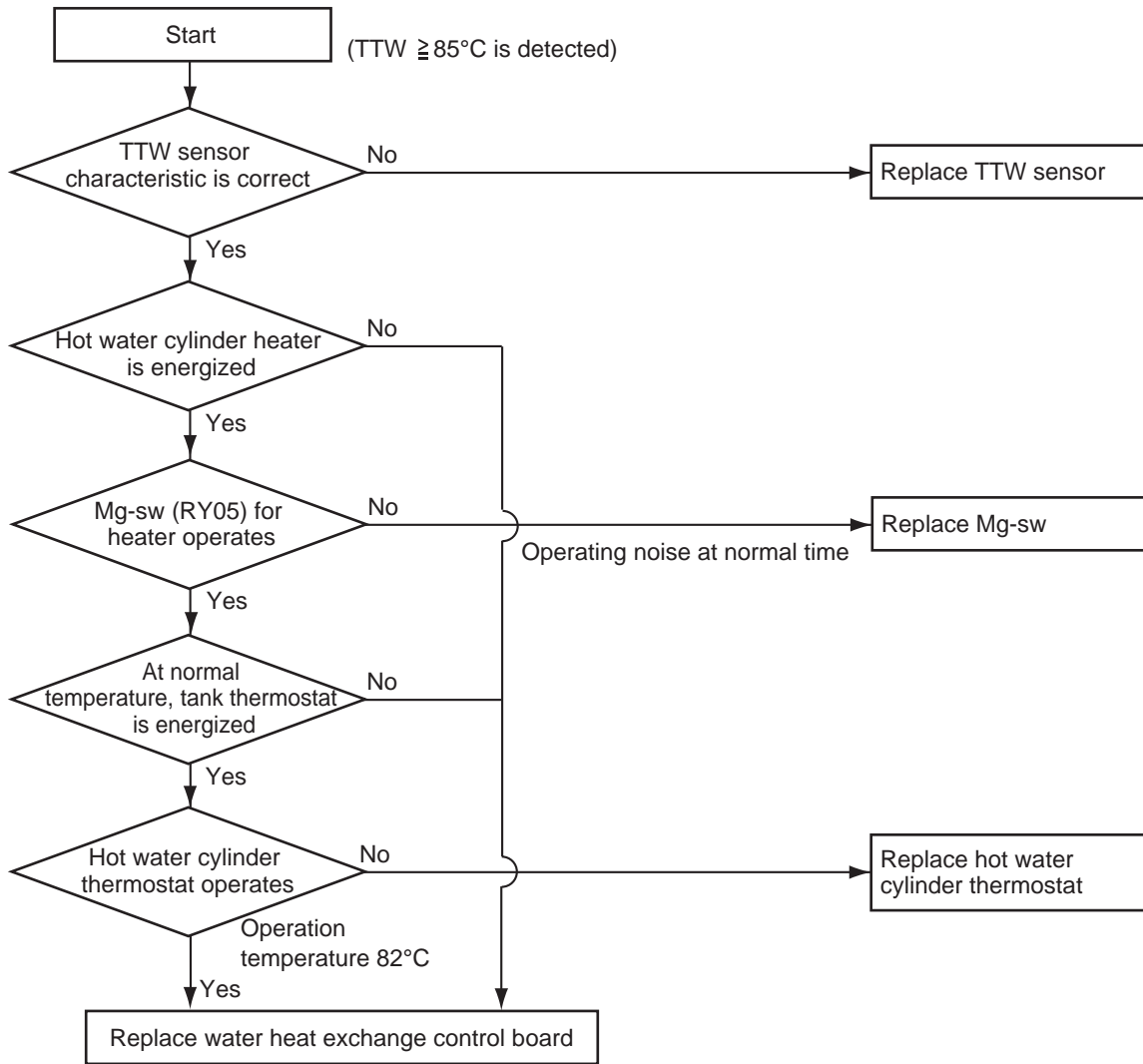

[A04] Error Freeze prevention control

When the outside temperature or inlet water temperature is low (approx. 20°C or lower) and the room load is large (operation frequency \geq rating), the freeze prevention control may be activated.

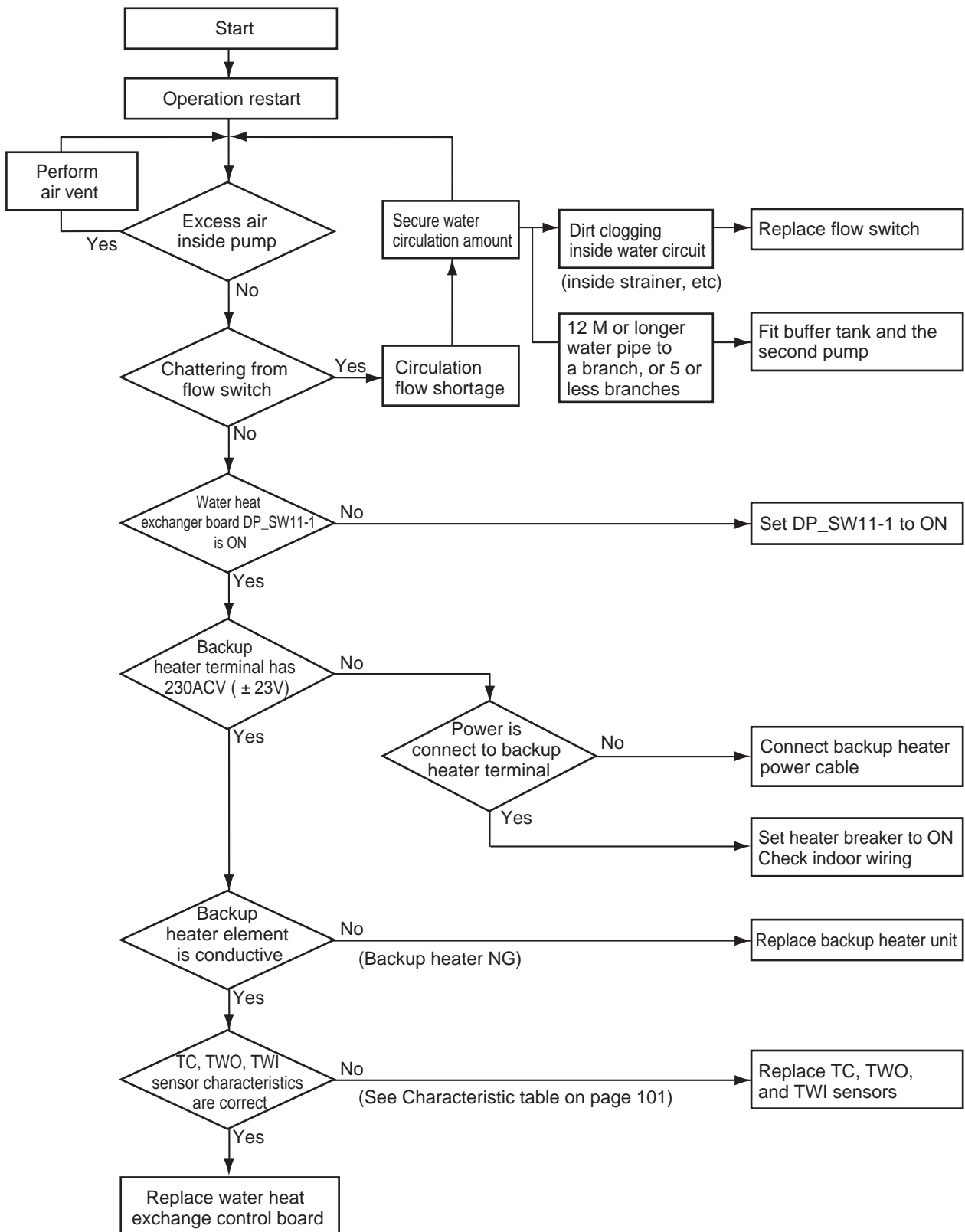

[A05] Error Piping freeze prevention control

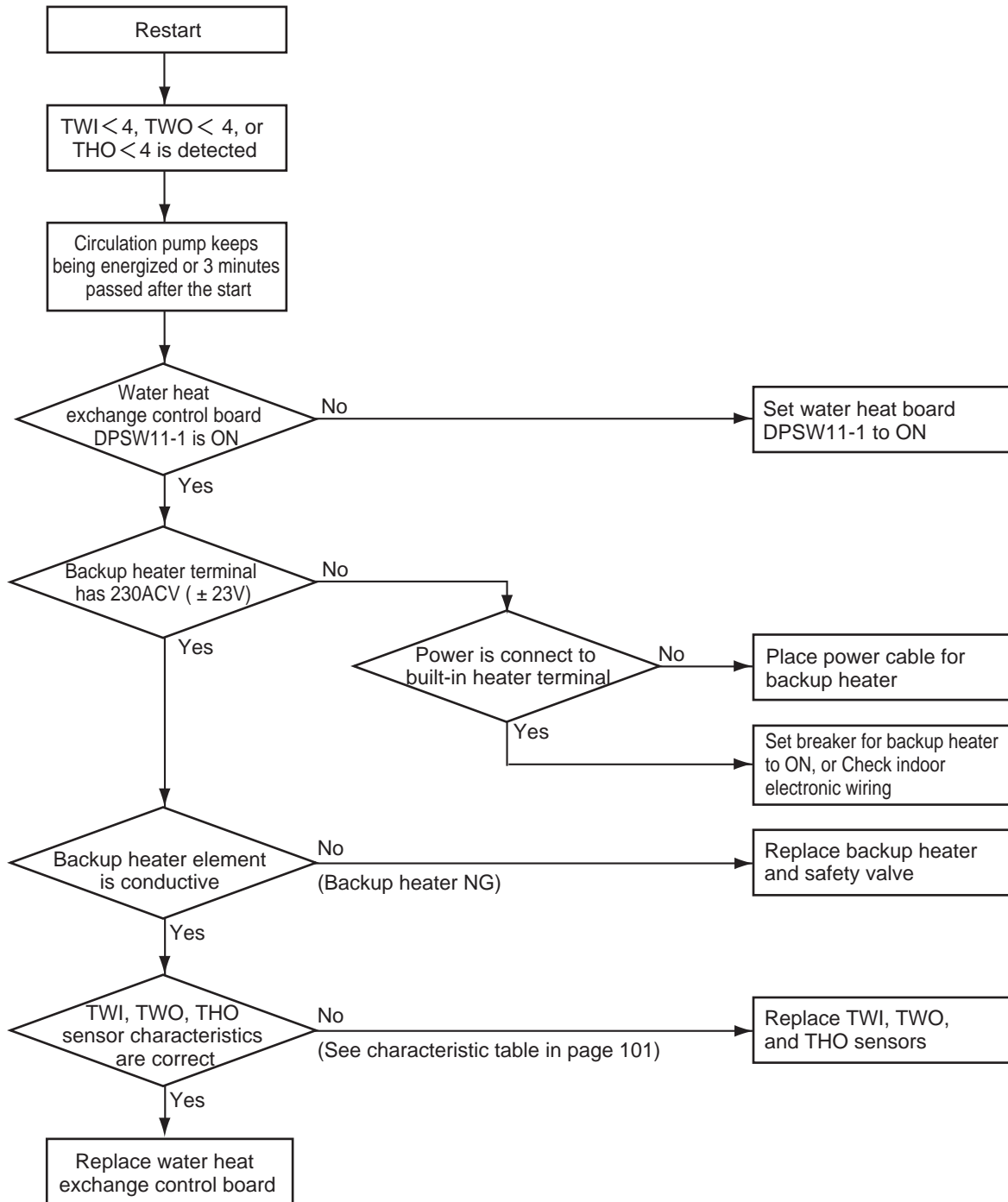

[A07] Error Pressure switch operation (Hot water supply/Heating operation)

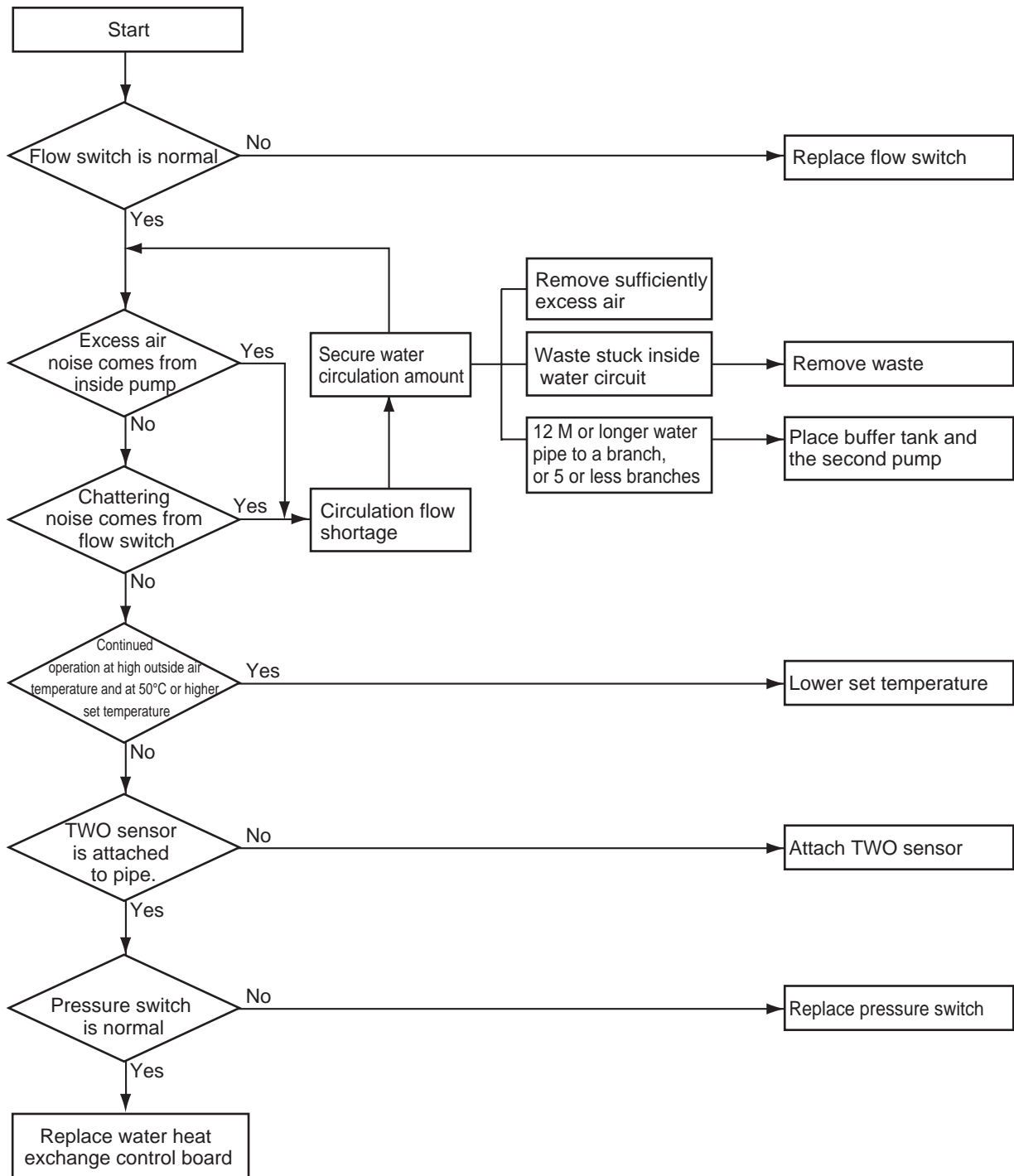

[A08] Error Lo pressure sensor lowering operation failure (Cooling/Defrosting operation)

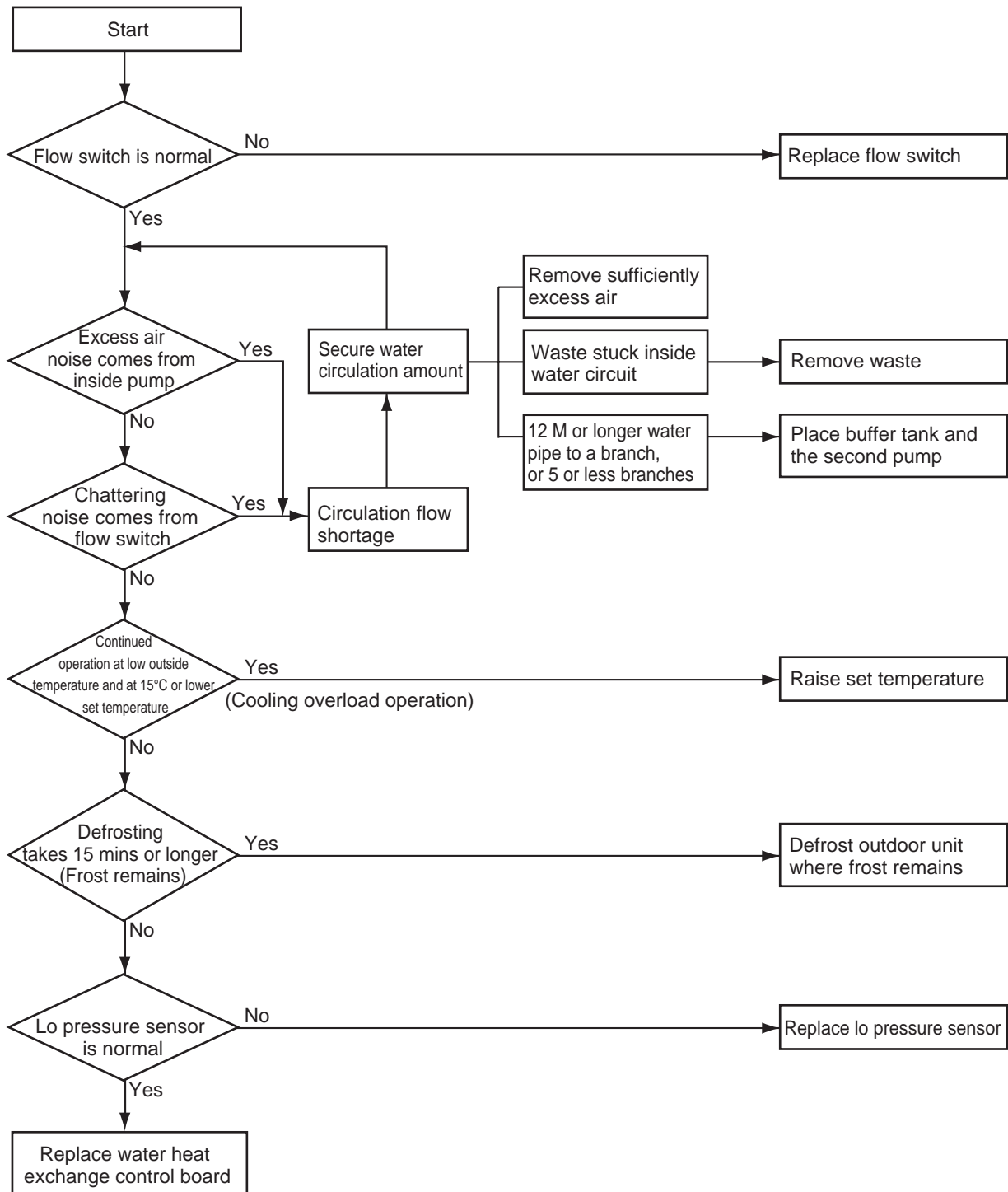

[A09] Error Overheat prevention thermostat failure (Hot water supply/Heating operation)

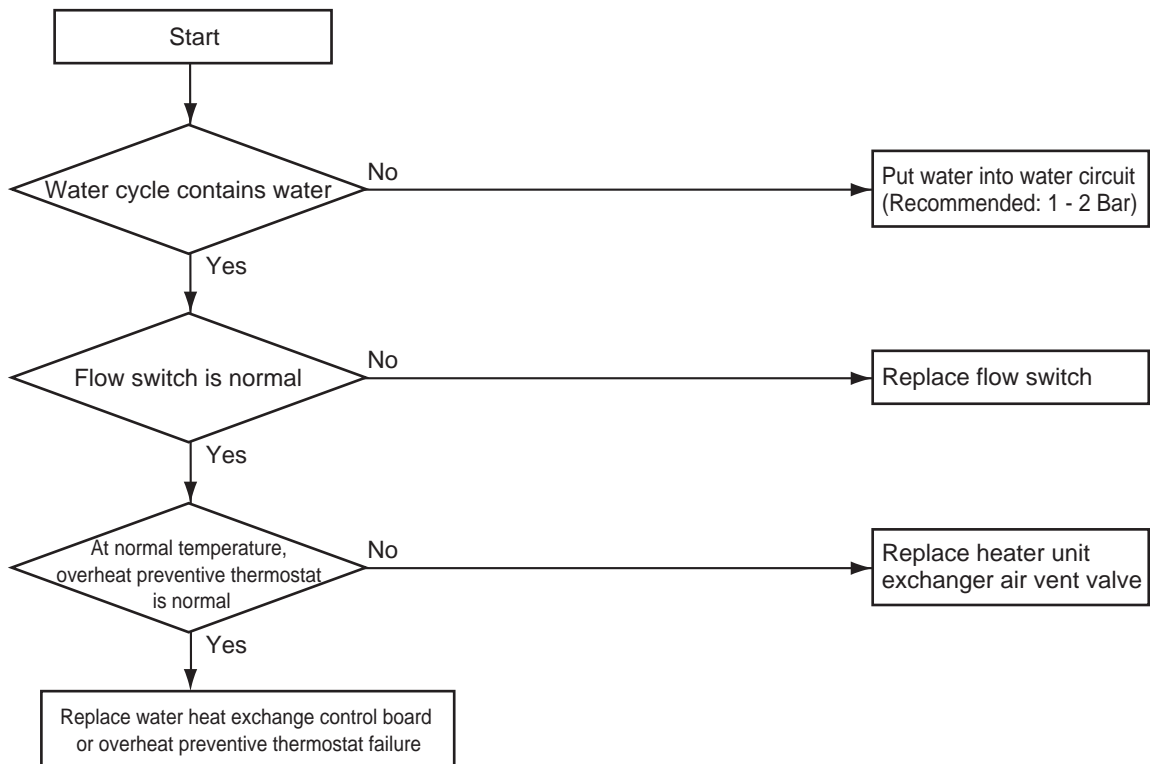

*Replace water heat exchange control board or overheat preventive thermostat failure: After the control board is replaced, if the same operation repeats, the overheat preventive thermostat is determined as defective (does not operate at 75°C).

[A11] Error Release protection operation

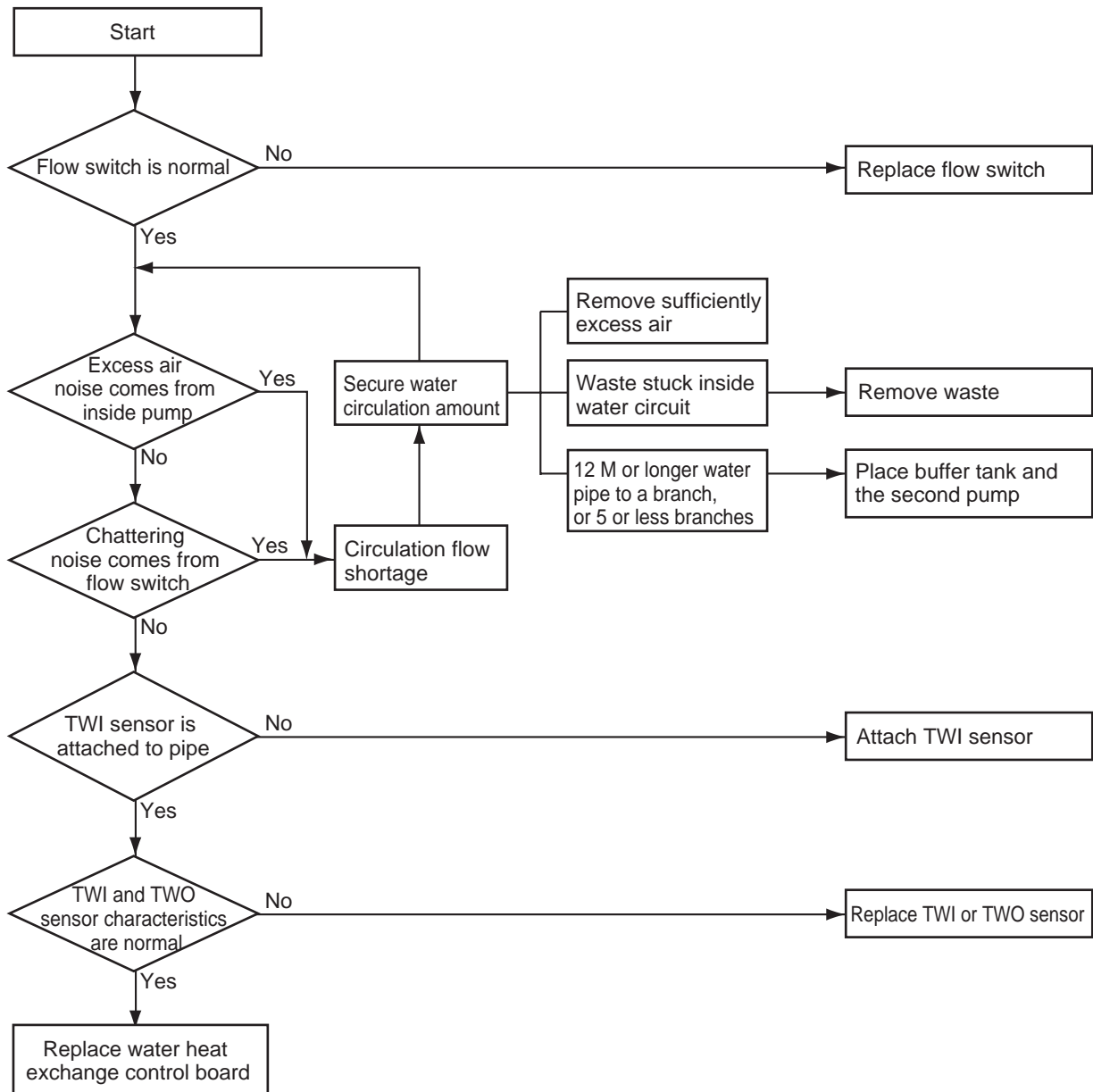

[A12] Error Heating or Hot water supply heater failure

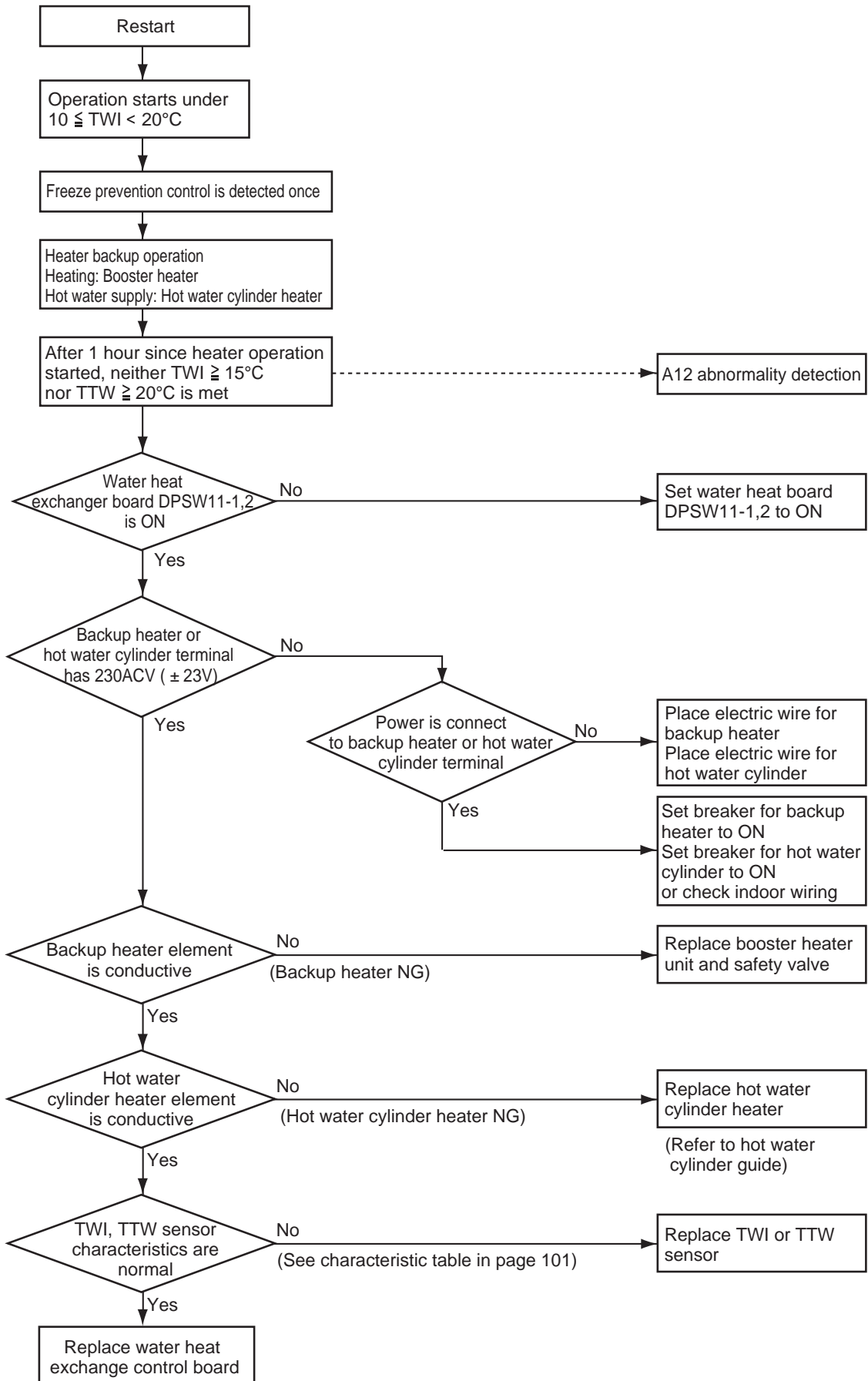

[E04] Error

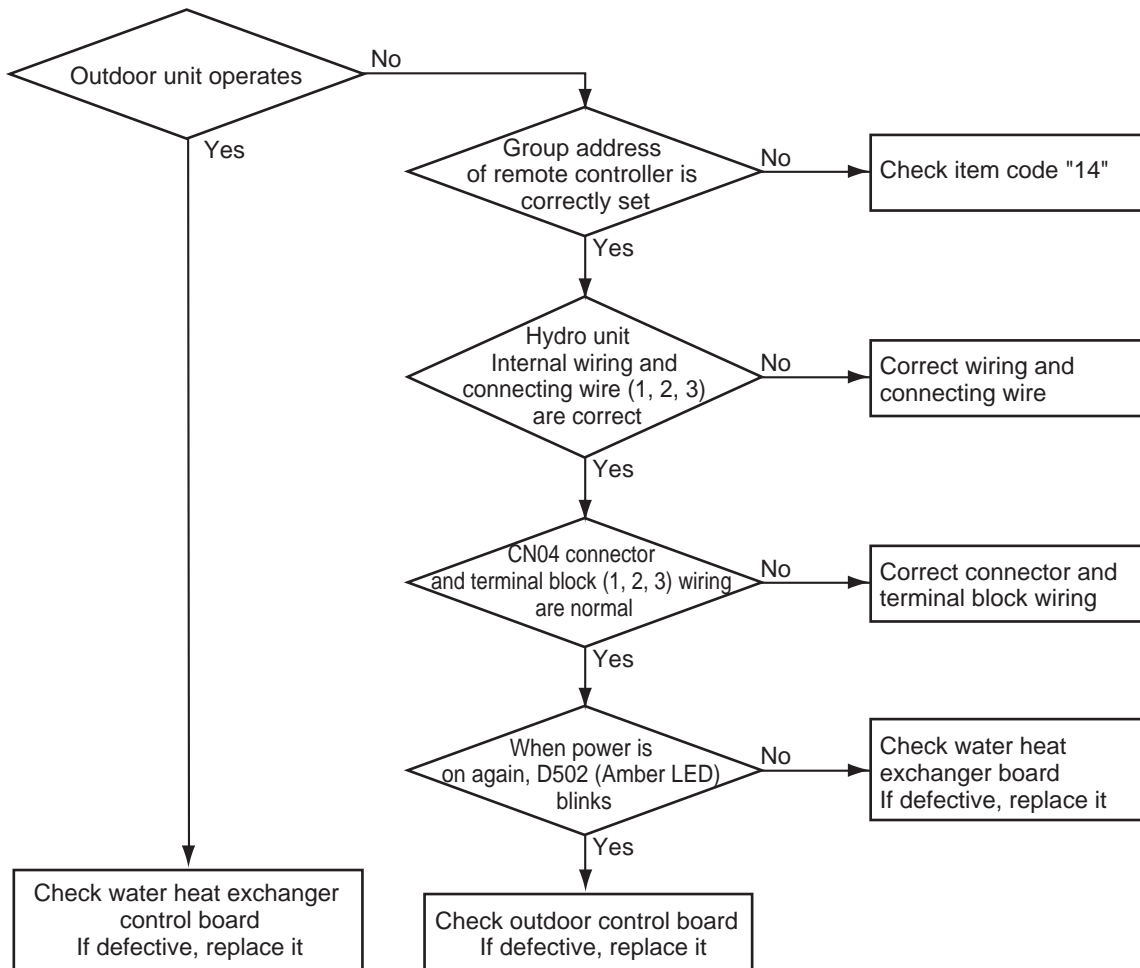

[F03] Error TC sensor failure

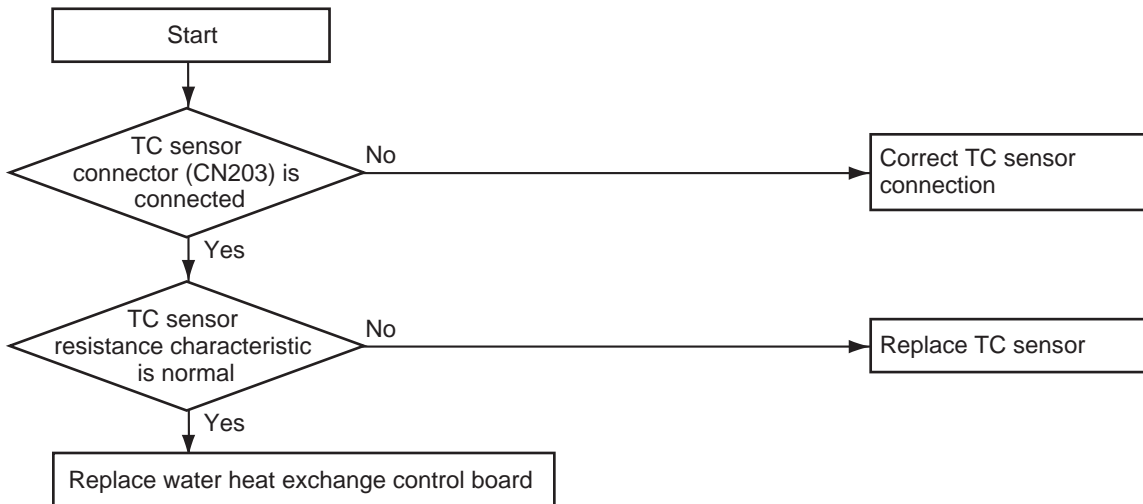

[F04] Error TD sensor failure

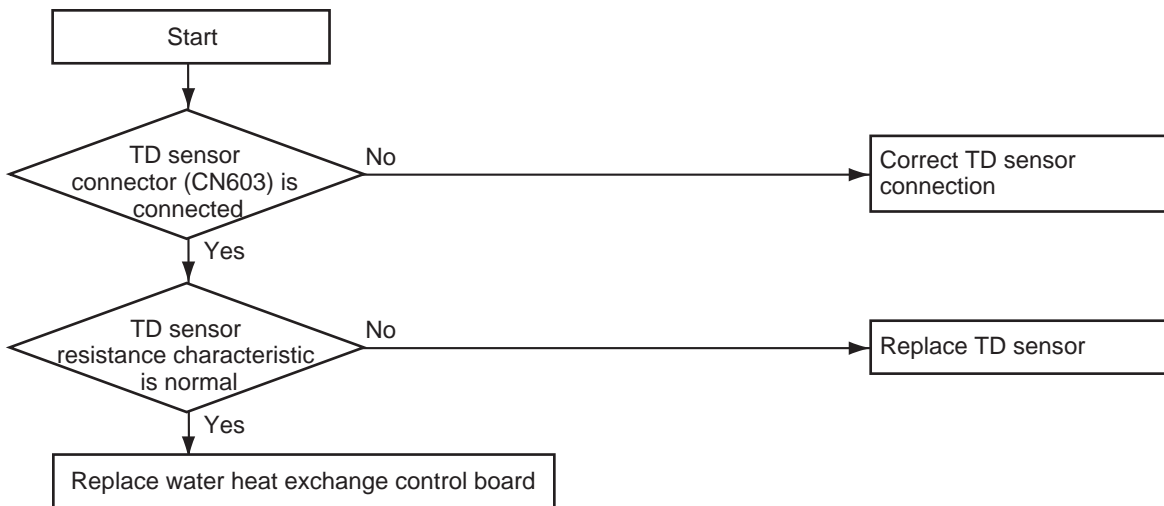

[F06] Error TE sensor failure

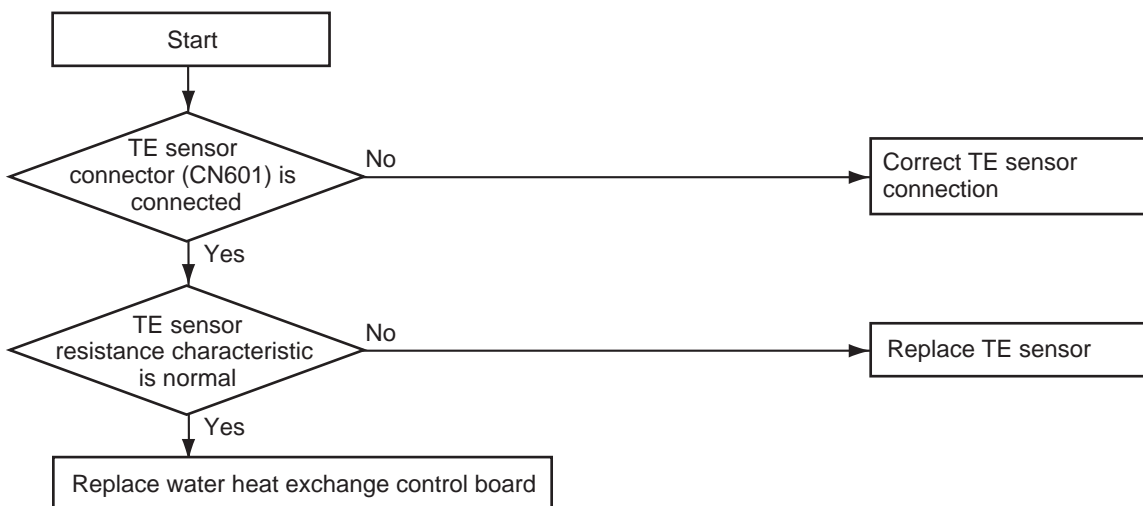

[F07] Error TL sensor failure

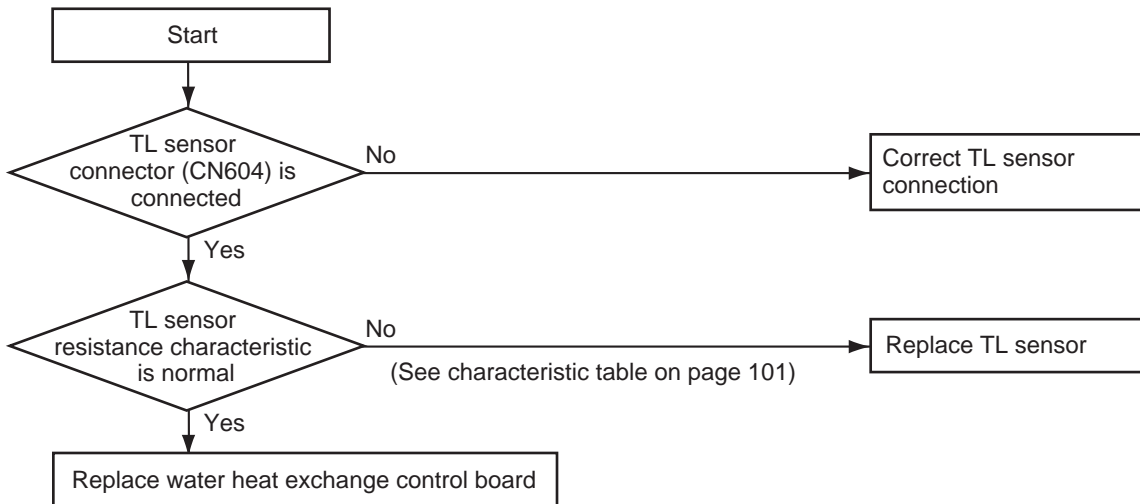

[F08] Error TO sensor failure

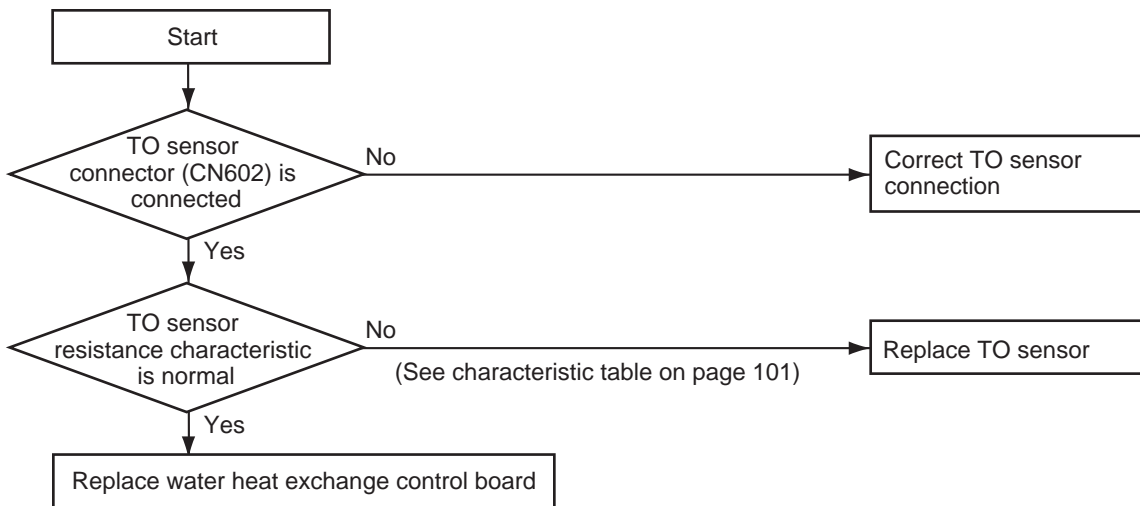

[F10] Error TWI sensor failure

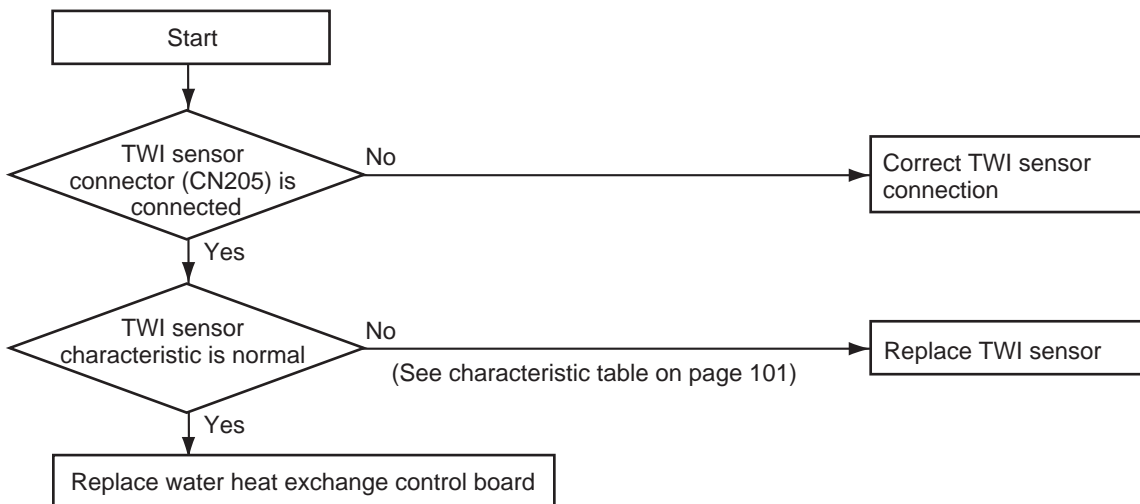

[F11] Error TWO sensor failure

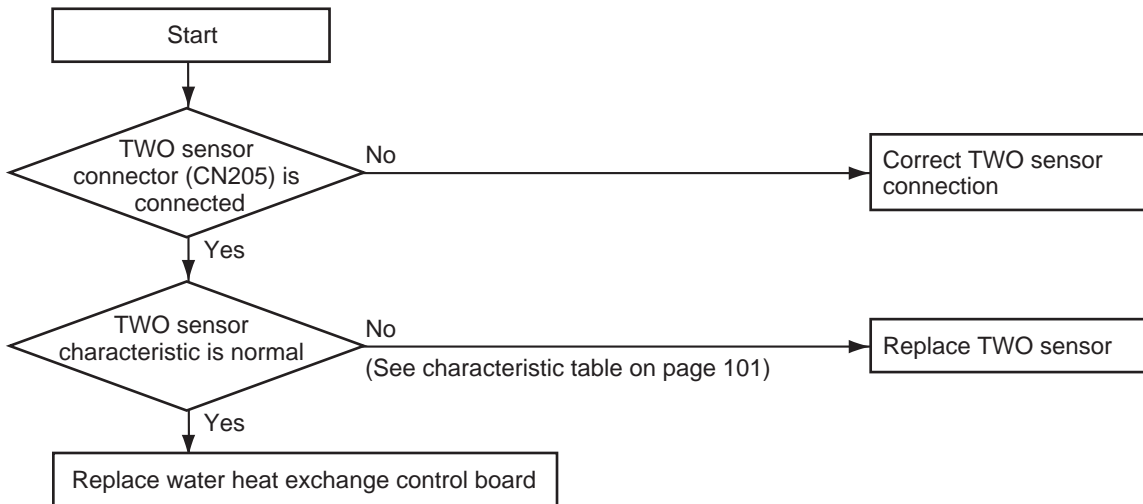

[F14] Error TTW sensor failure

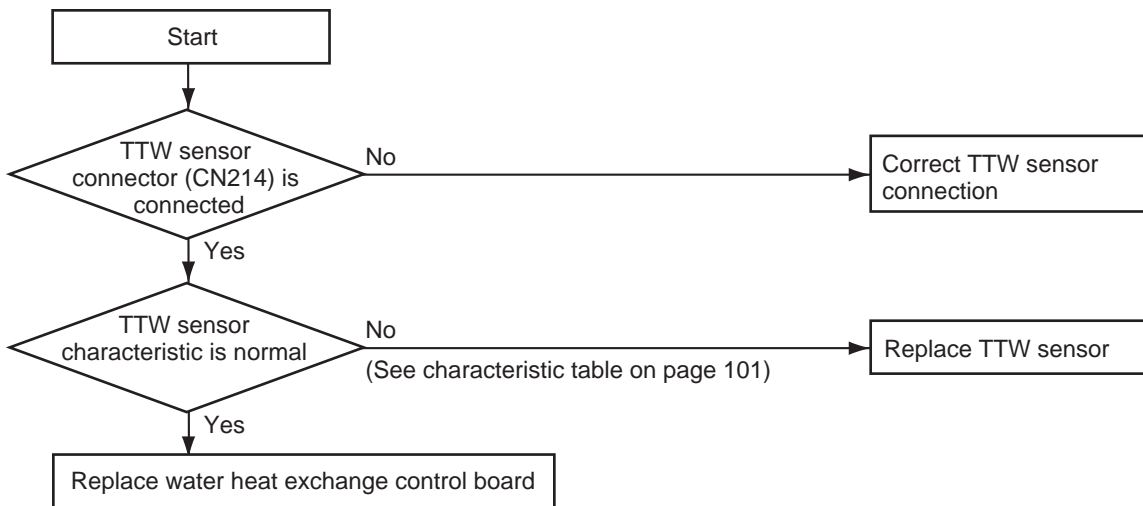

[F17] Error TFI sensor failure

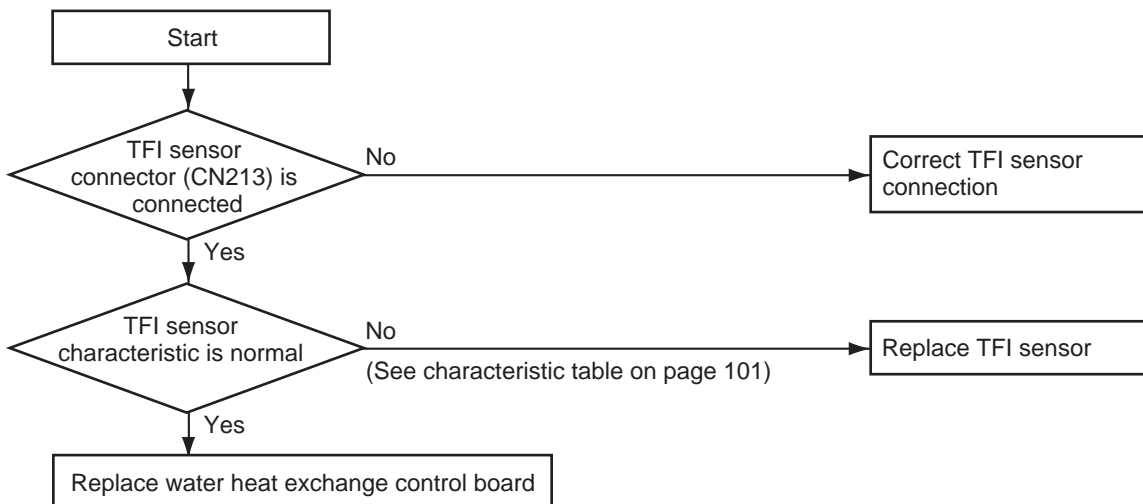

[F18] Error THO sensor failure

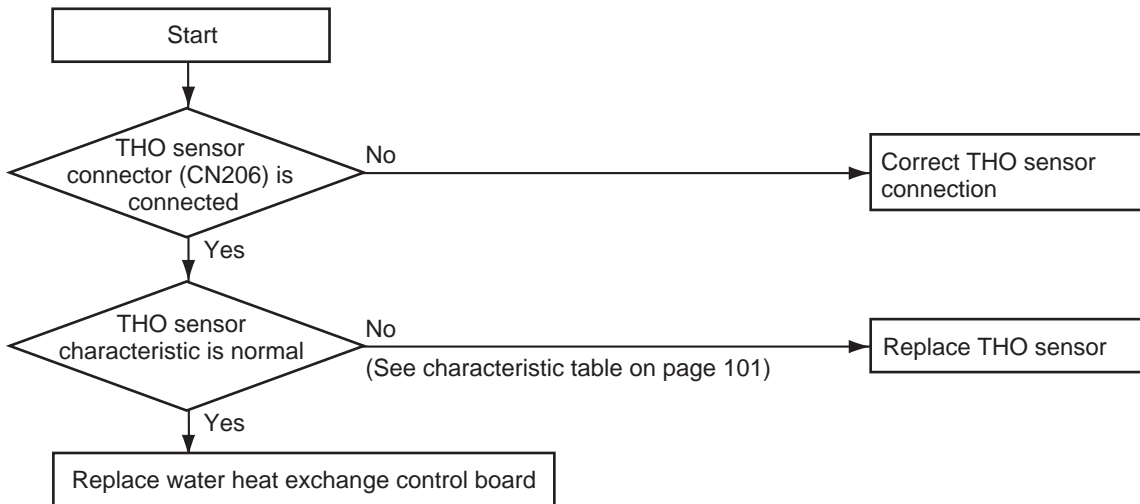

[F19] Error THO sensor detach failure

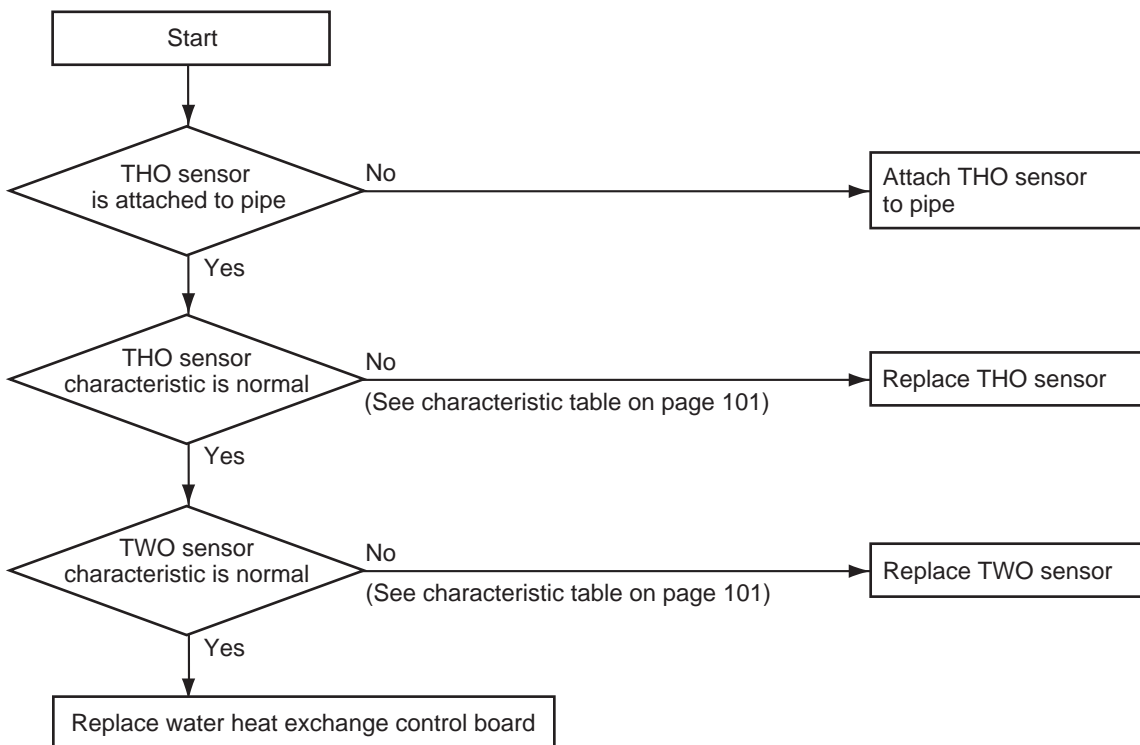

[F20] Error TFI detach failure

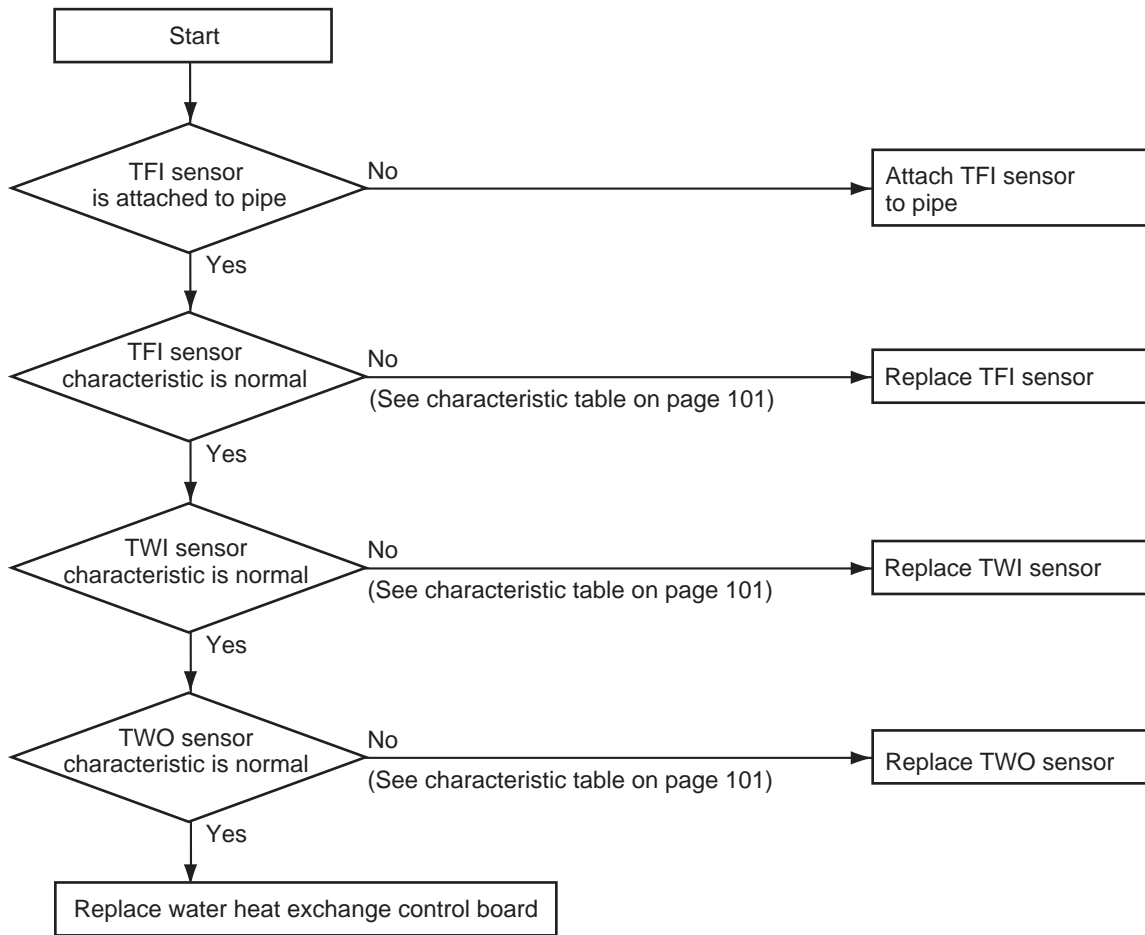

[F23] Error Lo pressure sensor detach failure

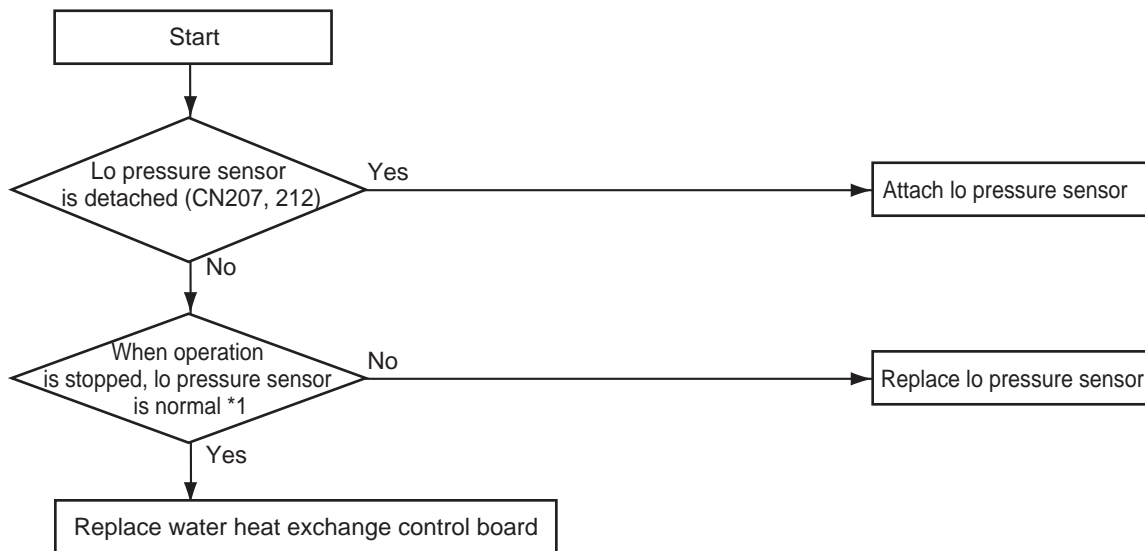

*1 How to determine: When operation is stopped

[F29] Error EEPROM failure

A failure is detected in the IC10 non-volatile memory on the water heat exchanger board during a hot water supply unit operation. Replace the service board.

* If the unit does not have EEPROM inserted when the power is turned on, or if EEPROM data read or write is unavailable, automatic address mode repeats. In this case, the intensive control unit displays [97 Abnormal].

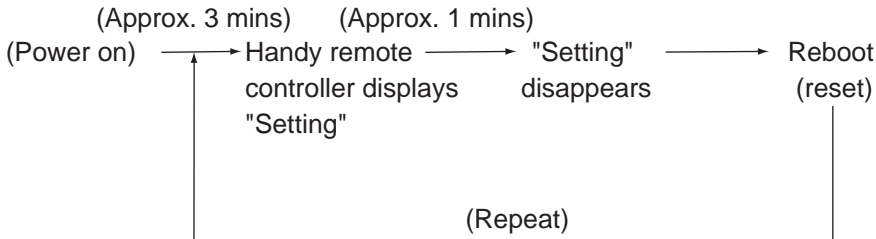

[F30] Error Enhanced IC failure

Enhanced IC on water heat exchanger control board is abnormal.
Replace the water heat exchanger control board to a service board.

[L07] Error

L07: In group control, one or more "individual" for group address exist.

At the time of power on, detecting the above failure automatically activates the automatic address setting mode.

(Check code is not output)

Note that if the above failure is detected in the automatic address setting mode, a check code may be output.

[L09] Error

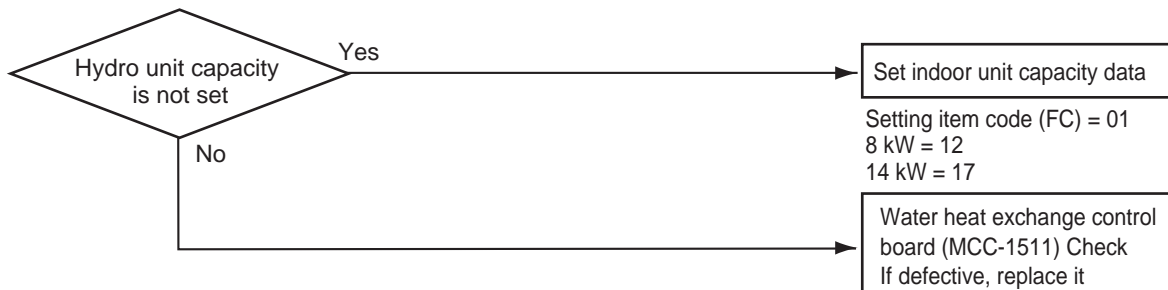

[L16] Error

In DP_SW12-2, 3 of main unit water heat exchanger, if ZONE1 is not set and ZONE2 is set, [L16] displays abnormality.



Set correctly DP_SW12-2, 3.

9-4-2. Outdoor Unit Failure Detection

Diagnosis procedure for each check code

- One check code may indicate multiple symptoms. In such a case, see the LED indication on the outdoor board to narrow down the check details.
- The handy remote controller displays a check code only when the same failure repeatedly occurs while the LED on the outdoor board indicates an error even if it occurs only once. This may cause indication inconsistency between the remote controller and LED.

Outdoor board LED indication method

<p>Dip switch setting</p> <ul style="list-style-type: none"> • Setting 1 only of SW803 to ON indicates the latest failure. Because the error history is recorded, you can see the detail even after the power is once turned off. (Not including outside air temperature sensor (TO) failure) • After check work is done or when outside air temperature sensor (TO) failure is detected, set all the SW803 switches to OFF. (An abnormality now is indicated.) 	<p><Latest abnormality> <Abnormality now> SW803 1 only is ON SW803 All OFF (Initial status)</p>  																								
<p>Indication switching</p> <ul style="list-style-type: none"> • One or more LEDs of D800 through D804 lit yellow indicates that a failure occurred. <Indication 1> • With the status above, pressing the SW800 button for one second causes the yellow LED to blink. <Indication 2> • Pressing again SW800 for one second or longer returns to <Indication 1>. • The combination of <Indication 1> and <Indication 2> can determine what kind of abnormality. 	<p><Indication 1> ⇔ <Indication 2> (Normal) (Abnormality occurs) (Press SW800)</p> <table border="0"> <tr> <td>D800 (yellow)</td> <td>●</td> <td>○</td> <td>●</td> </tr> <tr> <td>D801 (yellow)</td> <td>●</td> <td>○</td> <td>●</td> </tr> <tr> <td>D802 (yellow)</td> <td>●</td> <td>●</td> <td>◎</td> </tr> <tr> <td>D803 (yellow)</td> <td>●</td> <td>●</td> <td>●</td> </tr> <tr> <td>D804 (yellow)</td> <td>●</td> <td>○</td> <td>●</td> </tr> <tr> <td>D805 (green)</td> <td>○</td> <td>○</td> <td>○</td> </tr> </table> <p>(Example of outlet temperature sensor failure)</p> <p>●...Off ○...Light ◎...Blink</p>	D800 (yellow)	●	○	●	D801 (yellow)	●	○	●	D802 (yellow)	●	●	◎	D803 (yellow)	●	●	●	D804 (yellow)	●	○	●	D805 (green)	○	○	○
D800 (yellow)	●	○	●																						
D801 (yellow)	●	○	●																						
D802 (yellow)	●	●	◎																						
D803 (yellow)	●	●	●																						
D804 (yellow)	●	○	●																						
D805 (green)	○	○	○																						

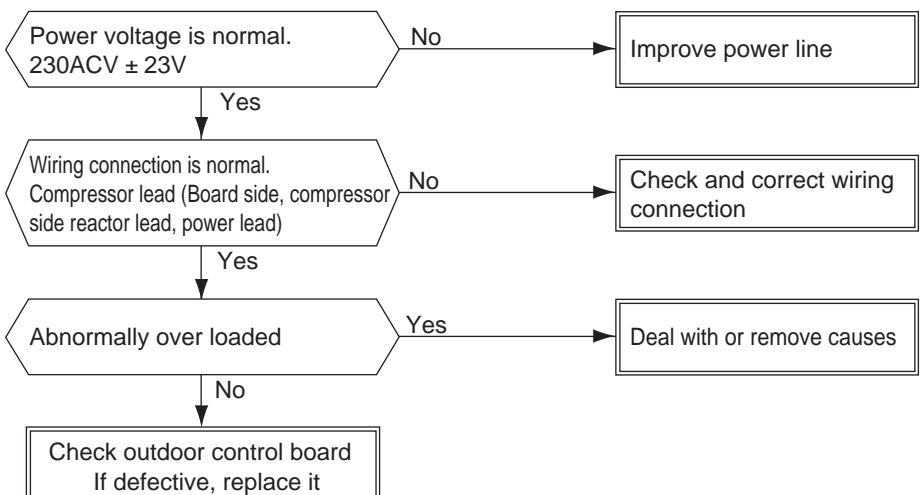
Check code	Outdoor LED indication	Check and Action procedure (No specific description indicates outdoor unit parts.)
[H01]	<Indication 1> <Indication 2> ● ◎ ● ● ○ ● ● ● ○ ● ○ ○	<p>[Compressor fails]</p> 

Check code	Outdoor LED indication	Check and Action procedure (No specific description indicates outdoor unit parts.)
[H02]	<Indication 1> <Indication 2> ● ● ● ◎ ○ ● ● ● ○ ● ○ ●	[Compressor lock] <pre> graph TD A{{Power voltage is normal. 230ACV ± 23V}} -- No --> B[Improve power line] A -- Yes --> C{{Wiring connection is normal. Compressor lead (board side, compressor side) reactor, power lead}} C -- No --> D[Check and correct wiring connection] C -- Yes --> E{{Compressor is normal.}} E -- No --> F{{Refrigerant stays inside.}} F -- No --> G[Lock compressor and replace it.] F -- Yes --> H{{Pulse motor valve operates normally.}} H -- No --> I[TE, TS sensor pulse motor valve check If defective, replace] H -- Yes --> J[Check outdoor board If defective, replace it] E -- Yes --> J </pre>
[H04]	<Indication 1> <Indication 2> ● ● ● ◎ ○ ● ● ● ○ ●	[Case thermostat operation] <pre> graph TD A{{CN609 connector and case thermostat is normal.}} -- No --> B[Correct connector Replace case thermostat] A -- Yes --> C{{If case thermostat is short circuited, cooling and heating can operate.}} C -- No --> D[Check outdoor board If defective, replace it] C -- Yes --> E{{No gas leakage. Enough Refrigerant.}} E -- No --> F[Correct defective portion Re-charge refrigerant] E -- Yes --> G{{Service valve is fully opened.}} G -- No --> H[Open fully service valve] G -- Yes --> I{{Pulse motor valve is normal.}} I -- No --> J[Correct defective portion Replace defective parts] I -- Yes --> K[Check for piping collapse and break. If defective, repair or replace it.] </pre>
[L10]	<Indication 1> <Indication 2> ● ● ● ◎ ○ ● ● ● ○ ●	[Model not set] Only when service board is used <div style="border: 1px solid black; padding: 5px; width: fit-content;"> Cut jumper line by following the instruction comes with the service board package </div>

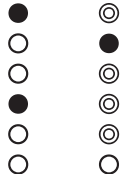
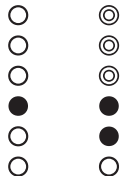
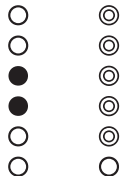
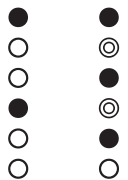
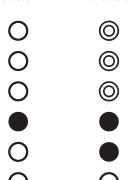
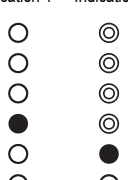
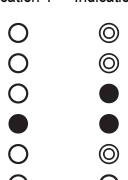
Check code	Outdoor LED indication	Check and Action procedure (No specific description indicates outdoor unit parts.)
[L29]		* Any of the following abnormality may occur. Seeing the LED on the outdoor board can determine which abnormality occurs. Communication failure between MCUs, Heat sink temperature sensor (TH) failure, EEPROM failure, Model not specified, Heat sink overheat failure, gas leakage detection, 4-way valve invert failure
	<Indication 1> <Indication 2> 	[Communication failure between MCUs] <div style="border: 1px solid black; padding: 5px; width: fit-content; margin: 10px auto;"> Check outdoor control board If defective, replace it </div>
	<Indication 1> <Indication 2> 	[Heat sink temperature sensor (TH) failure] → See [F13] details
	<Indication 1> <Indication 2> 	[EEPROM failure] → See [F31] details
	<Indication 1> <Indication 2> 	[Model not set] → See [L10] details
	<Indication 1> <Indication 2> 	[Heat sink overheat failure] → See [P07] details
	<Indication 1> <Indication 2> 	[Gas leakage failure] → See [P15] details
	<Indication 1> <Indication 2> 	[4-way valve invert failure] → See [P19] details

Check code	Outdoor LED indication	Check and Action procedure (No specific description indicates outdoor unit parts.)
[P03]	<Indication 1> <Indication 2> ○ ◎ ○ ◎ ○ ● ● ● ○ ● ○ ○	[Abnormal outlet temperature]
[P04]	<Indication 1> <Indication 2> ● ● ● ● ○ ◎ ● ● ○ ● ○ ○ <Indication 1> <Indication 2> ○ ◎ ○ ● ○ ◎ ● ● ○ ● ○ ○ <Indication 1> <Indication 2> ○ ● ○ ● ○ ◎ ● ● ○ ◎ ○ ○	* Any of the following abnormality may occur. Seeing the LED on the outside board can determine which abnormality occurs. Power source failure (Vdc), Hi pressure protection operation, Case thermostat operation [Case thermostat operation] → See [H04] details [Power source failure (Vdc)] → See [P05] details [Hi pressure protection operation] → See [P20] details
[P05]	<Indication 1> <Indication 2> ○ ◎ ○ ● ○ ◎ ● ● ○ ● ○ ○	[Power source failure (voltage defective, open phase)]

Check code	Outdoor LED indication	Check and Action procedure (No specific description indicates outdoor unit parts.)
[P07]	<Indication 1> <Indication 2> ○ ◎ ○ ◎ ○ ◎ ● ● ○ ● ○ ○	<p>[Heat sink overheat failure]</p> <pre> graph TD A{The screws are loose in motor drive element, Q200/300/400, of outdoor control board and rectifier, DB01/02/03. Radiation grease was not applied to backside of Q200, DB01, DB02, or DB03.} -- Yes --> B[Apply radiation grease as needed. Tighten screws (Be sure to place back the insulation sheet between Q300/400 and the heat sink.)] A -- No --> C{Ventilation flue of heat sink is cleared, Blower is not blocked (Short circuit, etc.)} C -- No --> D[Remove obstacles, Deal with short circuit] C -- Yes --> E[Check outdoor control board. If defective, replace it] </pre>
[P15]	<Indication 1> <Indication 2> ○ ◎ ○ ◎ ○ ◎ ● ◎ ○ ● ○ ○	<p>[Gas leakage detection]</p> <pre> graph TD A{No gas leakage. Appropriate refrigerant amount.} -- No --> B[Correct defective portion. Re-charge refrigerant] A -- Yes --> C{Pulse motor valve is normal.} C -- No --> D[Correct defective portion. Replace defective parts] C -- Yes --> E{Service valve is fully opened.} E -- No --> F[Open fully service valve] E -- Yes --> G{Piping collapse} G -- Yes --> H[Repair or replace pipe] G -- No --> I{Temperature sensor check. Discharge sensor CN603. Suction sensor CN600} I -- NG --> J[Correct connector. Replace sensor] I -- OK --> K[Check outdoor control board. If defective, replace it] </pre>

Check code	Outdoor LED indication	Check and Action procedure (No specific description indicates outdoor unit parts.)				
[P19]	<Indication 1> <Indication 2> ○ ◎ ○ ◎ ○ ● ● ● ○ ◎ ○ ○	<p>[4-way valve invert failure]</p> <p>Outdoor control board operation check direction (Self-hold valve)</p> <p>1) With the dip switch SW804 set as in the table below, pressing SW801 for approx. 1 second can check the operation of switching to cooling cycle or to heating cycle.</p> <ul style="list-style-type: none"> • The board are energized for 10 seconds. • Take more than a minute for the next check because the parts (coil, resistance R700) generate large heat. (This does not apply when no coil is connected.) <p>2) After the check, set all the SW804 dip switches to OFF.</p> <table border="1" data-bbox="523 1317 1425 1570"> <thead> <tr> <th data-bbox="523 1317 975 1350">Switching to cooling cycle</th> <th data-bbox="979 1317 1425 1350">Switching to heating cycle</th> </tr> </thead> <tbody> <tr> <td data-bbox="523 1357 975 1570"> </td> <td data-bbox="979 1357 1425 1570"> </td> </tr> </tbody> </table> <p>Note: Check with a tester With an analog tester: If a tester shows 180DCV or higher, the board is good. With digital tester: Although values shown has some range, if its maximum value is 180DCV or higher, the board is good.</p>	Switching to cooling cycle	Switching to heating cycle		
Switching to cooling cycle	Switching to heating cycle					

Check code	Outdoor LED indication	Check and Action procedure (No specific description indicates outdoor unit parts.)
[P20]	<Indication 1> <Indication 2> ○ ● ○ ● ○ ◎ ● ● ○ ◎ ○ ○	<p>[Hi pressure protection operation]</p> <pre> graph TD Start([Service valve is fully opened.]) -- No --> Act1[Open fully service valve] Start -- Yes --> Box1[Reset the power source and perform a trial operation according to the season.] Box1 -- Heating season Heating operation --> Dec1{{Outdoor TL sensor is normal. (Measure resistance)}} Dec1 -- No --> Act2[Replace sensor] Dec1 -- Yes --> Dec2{{Outdoor fan is free from crack or looseness.}} Dec2 -- No --> Act3[Check outdoor fan. If defective, replace or tighten it] Dec2 -- Yes --> Dec3{{Outdoor fan operates normally.}} Dec3 -- No --> Act4[Check the same item as those for [P22] abnormality] Dec3 -- Yes --> Dec4{{Something prevents outdoor unit heat exchange - Clogged heat exchanger - short circuit}} Dec4 -- Yes --> Act5[Remove the disturbing element] Dec4 -- No --> Box2[Check for refrigerant overcharged, clogged cycle, pipe break, abnormal overload, etc. If defective, repair defective portion] Box1 -- Cooling season Cooling operation --> Dec5{{Something prevents heat exchange of hydro unit. - Clogged filter - Clogged heat exchanger - Short circuit}} Dec5 -- Yes --> Act6[Remove the disturbing element] Dec5 -- No --> Box3[Check for refrigerant overcharged, clogged cycle, pipe break, abnormal overload, etc. If defective, repair defective portion] </pre>

Check code	Outdoor LED indication	Check and Action procedure (No specific description indicates outdoor unit parts.)								
[P22]	<Indication 1> <Indication 2> ○ ● ○ ◎ ○ ◎ ● ● ○ ◎ ○ ○	<p>[Blower system failure]</p> <pre> graph TD A{Power voltage is normal (230ACV ± 23V)} -- No --> B[Check wiring Request power source repair] A -- Yes --> C{When not energized, the fan motor can be smoothly rotated by hand. Fan motor coil resistance is normal. Between red - white leads 12 - 20Ω Between white - black leads 12 - 20Ω Between black - red leads 12 - 20Ω} C -- No --> D[Replace fan motor] C -- Yes --> E[Check outdoor control board If defective, replace it] </pre> <p>Outdoor fan sole operation check</p> <p>1) With the dip switch SW804 set as in the table below, pressing SW801 for approx. 1 second can check the outdoor fan sole operation. Perform this check to determine which of upper or lower fan has a problem.</p> <ul style="list-style-type: none"> • When SW801 is pressed again for 1 second or when 2 minutes has passed, the fan stops. <p>2) After the check, set all the SW804 dip switches to OFF.</p> <table border="1" data-bbox="523 1032 975 1223"> <thead> <tr> <th colspan="2">Outdoor fan sole operation</th> </tr> </thead> <tbody> <tr> <td style="text-align: center;">SW804</td> <td style="text-align: center;">SW801</td> </tr> <tr> <td style="text-align: center;"> </td> <td style="text-align: center;"> </td> </tr> <tr> <td></td> <td style="text-align: center;">Press</td> </tr> </tbody> </table>	Outdoor fan sole operation		SW804	SW801				Press
Outdoor fan sole operation										
SW804	SW801									
	Press									
[P26]	<Indication 1> <Indication 2> ○ ● ○ ◎ ○ ● ● ◎ ○ ◎ ○ ○	<p>[Compressor drive element shorted out]</p> <pre> graph TD A{The connection between compressor lead and reactor is correct. (Check with wiring diagram)} -- No --> B[Correct wiring] A -- Yes --> C{A operation without compressor lead does not cause the same problem.} C -- No --> D[Replace outdoor board] C -- Yes --> E[Compressor check (rare short circuit, etc.) If defective, replace it] </pre>								
[P29]	<Indication 1> <Indication 2> ○ ◎ ○ ● ○ ◎ ● ◎ ○ ◎ ○ ○	<p>[Position detection circuit failure]</p> <p>Check outdoor control board If defective, replace it</p>								

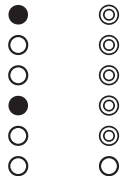
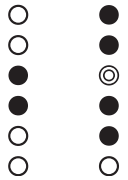
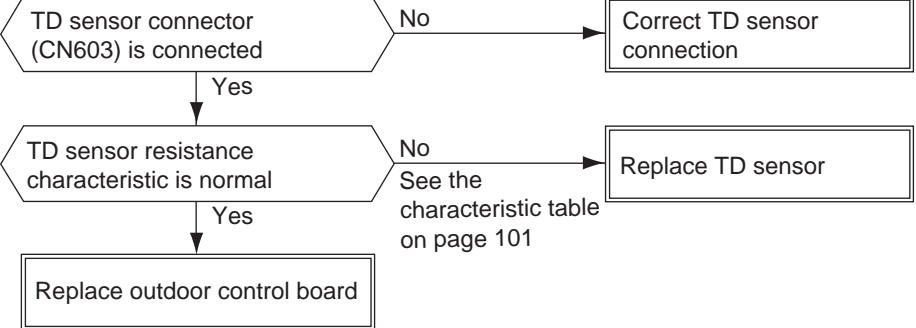
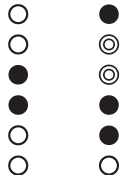
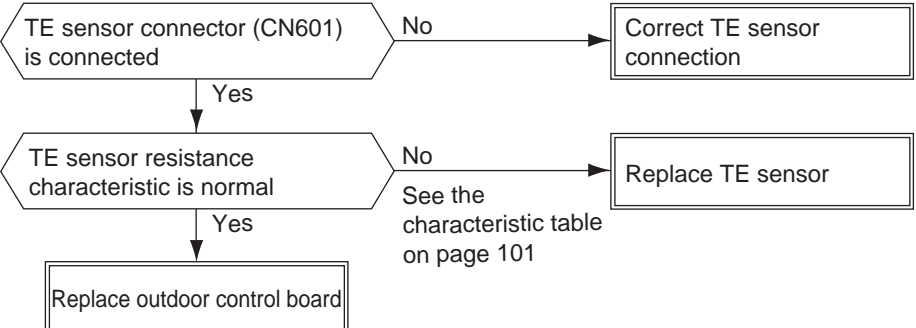
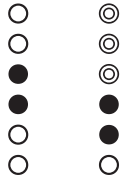
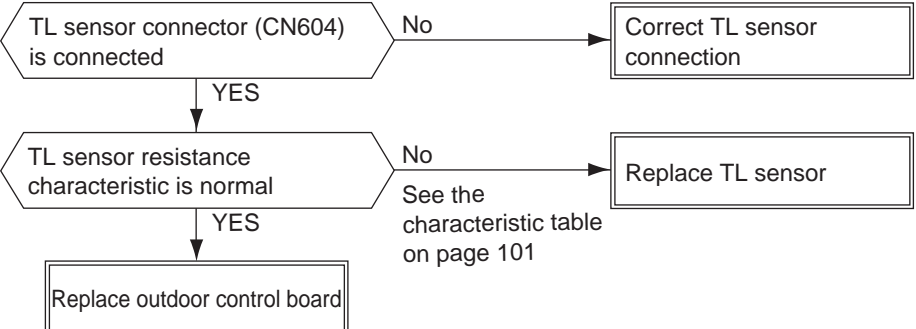
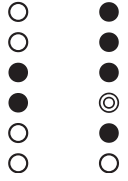
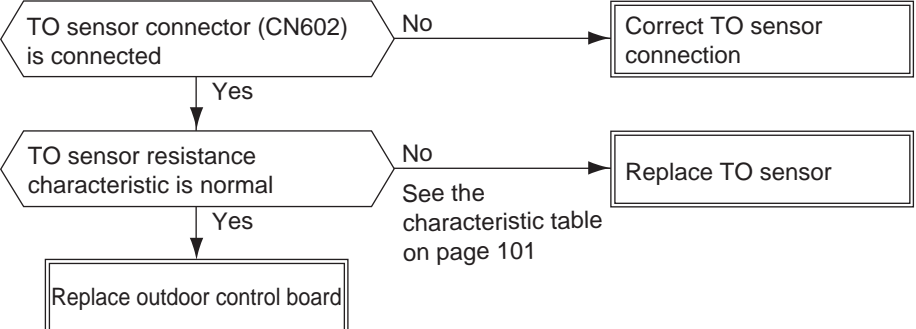
Check code	Outdoor LED indication	Check and Action procedure (No specific description indicates outdoor unit parts.)
No code	<Indication 1> <Indication 2> 	[Discharge abnormality] Compressor's loss of synchronism due to rapid load change, etc. * Although the outdoor LED indicates abnormality, the compressor restarts and no abnormality is confirmed. * This may occur due to the open phase of the compressor or wiring detach.
[F04]	<Indication 1> <Indication 2> 	[Discharge temperature sensor (TD) failure] 
[F06]	<Indication 1> <Indication 2> 	[Heat exchanger temperature sensor (TE) failure] 
[F07]	<Indication 1> <Indication 2> 	[Heat exchanger temperature sensor (TL) failure] 
[F08]	<Indication 1> <Indication 2> 	[Outside air temperature sensor (TO) failure] 

Check code	Outdoor LED indication	Check and Action procedure (No specific description indicates outdoor unit parts.)
[F12]	<Indication 1> <Indication 2> ○ ● ○ ● ● ◎ ● ◎ ○ ● ○ ◎	[Suction temperature sensor (TS) failure] <pre> graph TD A{TS sensor connector (CN600) is connected} -- No --> B[Correct TS sensor connection] A -- Yes --> C{TS sensor resistance characteristic is normal} C -- No --> D[Replace TS sensor] C -- Yes --> E[Replace outdoor control board] </pre>
[F13]	<Indication 1> <Indication 2> ○ ◎ ○ ● ● ◎ ● ◎ ○ ● ○ ◎	[Heat sink temperature sensor (TH) failure] <div style="border: 1px solid black; padding: 5px; width: fit-content;">Replace outdoor control board</div>
[F15]	<Indication 1> <Indication 2> ○ ◎ ○ ◎ ● ◎ ● ◎ ○ ● ○ ◎	[Heat exchanger sensor (TE, TS) wrong wiring] <pre> graph TD A{TE and TS sensor is attached to the correct position.} -- No --> B[Correct sensor attaching position] A -- Yes --> C{TE sensor resistance characteristic is normal} C -- No --> D[Replace TE sensor] C -- Yes --> E{TS sensor resistance characteristic is normal} E -- No --> F[Replace TS sensor] E -- Yes --> G[Replace outdoor control board] </pre>
[F31]	<Indication 1> <Indication 2> ○ ◎ ○ ◎ ● ◎ ● ◎ ○ ◎ ○ ◎	[EEPROM failure] <div style="border: 1px solid black; padding: 5px; width: fit-content;">Check outdoor control board If defective, replace it</div>

9-4-3. Temperature sensor, temperature-resistance characteristic table

TC, TWI, TWO, TFI, TTW, TE, TS, TO sensors

Typical value

Temperature (°C)	Resistance value (kΩ)		
	(Minimum)	(Standard)	(Maximum)
-10	55.42	55.73	60.04
0	32.33	33.80	35.30
10	19.63	20.35	21.09
20	12.23	12.59	12.95
25	9.75	10.00	10.25
30	7.764	7.990	8.218
40	5.013	5.192	5.375
50	3.312	3.451	3.594
60	2.236	2.343	2.454
70	1.540	1.623	1.709
80	1.082	1.146	1.213
90	0.7740	0.8237	0.8761
100	0.5634	0.6023	0.6434

TD, TL sensors

Typical value

Temperature (°C)	Resistance value (kΩ)		
	(Minimum)	(Standard)	(Maximum)
0	150.5	161.3	172.7
10	92.76	99.05	105.6
20	58.61	62.36	66.26
25	47.01	49.93	52.97
30	37.93	40.22	42.59
40	25.12	26.55	28.03
50	17.00	17.92	18.86
60	11.74	12.34	12.95
70	8.269	8.668	9.074
80	5.925	6.195	6.470
90	4.321	4.507	4.696
100	3.205	3.336	3.468

TC, TWI, TWO, TFI, TTW, TE, TS, TO sensors

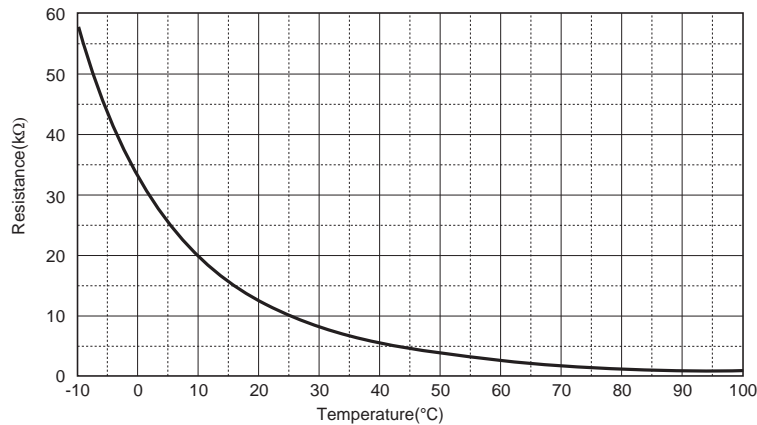

TD, TL sensors

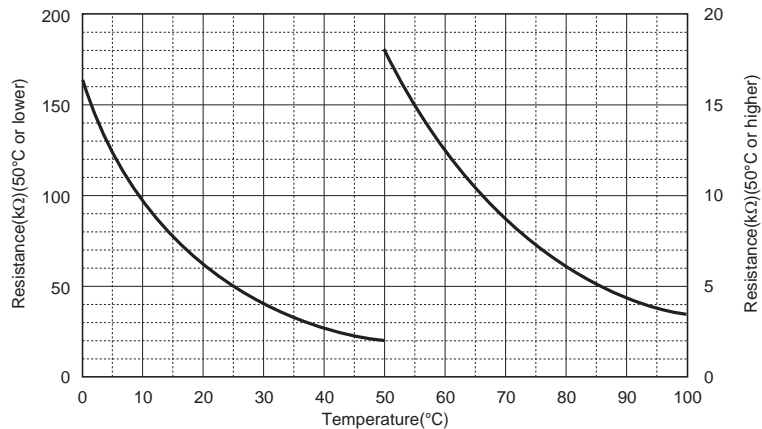

* Since the TH sensor (outdoor unit heat-sink temperature sensor) is built in the outdoor control board, the resistance value cannot be measured.

9-5. Operation check by PC board switch

9-5-1. Operation check mode

This mode allows to check the operations of the water 2-way valve, water 3-way valve, mixing valve, and circulating pump.

Operation check mode

(1) Preparation

- Turn all of the remote controls "OFF" for the hot water supply and heating.
- Turn off the hydro unit and the outdoor unit.
- Remove the front panel of the hydro unit.

(2) Operation check

- 1) Turn on the hydro unit and the outdoor unit.
- 2) Set SW06_2 to "ON".
- 3) Rotate switch SW01 to position "1" and press tactile switch SW07 for 5 sec. or longer.
- 4) Rotating the rotary SW01 allows to check each operation.
- 5) Set the DIP SW06 "OFF" to finish.

Rotary switch	Check contents	Remark
1	None	
2	2WV_W Alive for approx. 2 sec, not alive for 3 sec	
3	3WV_W	
4	Mixing valve Alive for 30 sec in the forward direction Alive for 30 sec in the reverse direction	
5	Built-in AC pump Alive / not alive for 20 sec	
6	Extended AC pump 1 Alive / not alive for 20 sec	
7	(Extended AC pump 2) Alive / not alive for 20 sec	Reserved
8	Water heat exchange backup heater Repeat heater 1, heater 2, and OFF every 20 sec	The built-in AC pump operates.
9	Hot water cylinder heater Alive / not alive for 10 sec	
10	Backup heater Alive / not alive for 10 sec	The built-in AC pump and external AC pump operate.
11	Check the alarm output. Output for 10 sec / no output for 10 sec	
12	Check the boiler output. Output for 10 sec / no output for 10 sec	
13	Check the defrost output. Output for 10 sec / no output for 10 sec	
14	Check the operation output. Output for 10 sec / no output for 10 sec	
15	Built-in AC pump continuous operation Continuously alive	Do not operate the AC pump alive continuously without any water in hydro unit.

9-6. Brief method for checking the key components

9-6-1. Hydro unit

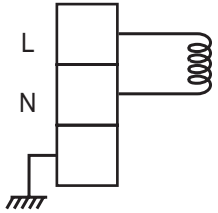
No.	Component name	Check procedure															
1	Water heat exchange temperature (TC) sensor	Remove the connector and measure the resistance value with a tester. (Normal temperature) <table border="1" style="margin-top: 10px;"> <thead> <tr> <th style="text-align: center;">Temperature</th> <th>0°C</th> <th>10°C</th> <th>20°C</th> <th>30°C</th> </tr> </thead> <tbody> <tr> <td>Sensor</td> <td rowspan="5" style="text-align: center; vertical-align: middle;">33.8 kΩ</td> <td rowspan="5" style="text-align: center; vertical-align: middle;">20.35 kΩ</td> <td rowspan="5" style="text-align: center; vertical-align: middle;">12.59 kΩ</td> <td rowspan="5" style="text-align: center; vertical-align: middle;">7.99 kΩ</td> </tr> <tr> <td>Water heat exchange temperature (TC) sensor</td> </tr> <tr> <td>Water inlet temperature (TWI) sensor</td> </tr> <tr> <td>Water outlet (TWO) sensor</td> </tr> <tr> <td>Hot water cylinder temperature (TTW) sensor</td> </tr> <tr> <td>Floor inlet temperature (TFI) sensor</td> </tr> </tbody> </table>	Temperature	0°C	10°C	20°C	30°C	Sensor	33.8 kΩ	20.35 kΩ	12.59 kΩ	7.99 kΩ	Water heat exchange temperature (TC) sensor	Water inlet temperature (TWI) sensor	Water outlet (TWO) sensor	Hot water cylinder temperature (TTW) sensor	Floor inlet temperature (TFI) sensor
	Temperature		0°C	10°C	20°C	30°C											
	Sensor		33.8 kΩ	20.35 kΩ	12.59 kΩ	7.99 kΩ											
	Water heat exchange temperature (TC) sensor																
	Water inlet temperature (TWI) sensor																
	Water outlet (TWO) sensor																
	Hot water cylinder temperature (TTW) sensor																
Floor inlet temperature (TFI) sensor																	
Water inlet temperature (TWI) sensor																	
Water outlet temperature (TWO) sensor																	
Hot water cylinder temperature (TTW) sensor																	
Floor inlet temperature (TFI) sensor																	
2	Circulating pump AC pump Type	Remove the connection cover of the pump, and measure the resistance with a tester. <div style="display: flex; align-items: center; margin-top: 10px;">  <table border="1" style="margin-left: 20px;"> <thead> <tr> <th>Location</th> <th>Resistance value</th> </tr> </thead> <tbody> <tr> <td>L-N</td> <td>100-200 Ω</td> </tr> </tbody> </table> </div>	Location	Resistance value	L-N	100-200 Ω											
	Location		Resistance value														
L-N	100-200 Ω																
UPS025-65K 130 (802XWH**-E) UPS25-80 130 (1402XWH**-E)																	

9-6-2. Outdoor unit

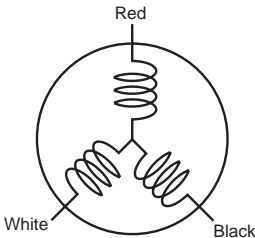
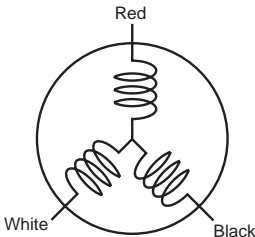
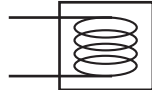
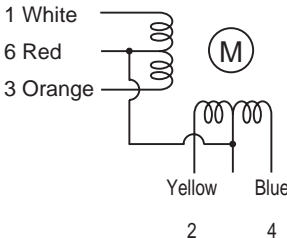
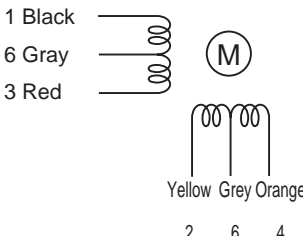
No.	Component name	Check procedure																
1	Compressor Type DA220A2F-22L (802H-E) DA422A3F-25M (1102,1402H-E)	<p>Measure the resistance value of each winding with a tester.</p>  <table border="1" data-bbox="893 392 1260 582"> <thead> <tr> <th>Location</th> <th>Resistance value</th> </tr> </thead> <tbody> <tr> <td>Red – White</td> <td>1.04-1.16 Ω</td> </tr> <tr> <td>White – Black</td> <td>1.04-1.16 Ω</td> </tr> <tr> <td>Black – Red</td> <td>1.04-1.16 Ω</td> </tr> </tbody> </table> <p>At 20°C</p>	Location	Resistance value	Red – White	1.04-1.16 Ω	White – Black	1.04-1.16 Ω	Black – Red	1.04-1.16 Ω								
Location	Resistance value																	
Red – White	1.04-1.16 Ω																	
White – Black	1.04-1.16 Ω																	
Black – Red	1.04-1.16 Ω																	
2	Outdoor fan motor Type ICF-280-A60-1 (802H-E) ICF-280-A100-1 (1102,1402H-E)	<p>Measure the resistance value of each winding with a tester.</p>  <table border="1" data-bbox="893 683 1444 918"> <thead> <tr> <th></th> <th>Location</th> <th>Resistance value</th> </tr> </thead> <tbody> <tr> <td rowspan="3">802H-E</td> <td>Red – White</td> <td rowspan="3">32.6 ± 3.3 Ω</td> </tr> <tr> <td>White – Black</td> </tr> <tr> <td>Black – Red</td> </tr> <tr> <td rowspan="3">1102,1402H-E</td> <td>Red – White</td> <td rowspan="3">14.8 ± 1.5 Ω</td> </tr> <tr> <td>White – Black</td> </tr> <tr> <td>Black – Red</td> </tr> </tbody> </table>		Location	Resistance value	802H-E	Red – White	32.6 ± 3.3 Ω	White – Black	Black – Red	1102,1402H-E	Red – White	14.8 ± 1.5 Ω	White – Black	Black – Red			
	Location	Resistance value																
802H-E	Red – White	32.6 ± 3.3 Ω																
	White – Black																	
	Black – Red																	
1102,1402H-E	Red – White	14.8 ± 1.5 Ω																
	White – Black																	
	Black – Red																	
3	4-way valve coil Type VHV-01AP552B1	<p>Measure the resistance value. 1473 Ω ± 103 Ω</p> 																
4	Pulse motor valve coil Type CAM-MD12TF-15 (802H-E)	<p>Measure the resistance value.</p> <p>1 White 6 Red 3 Orange</p>  <table border="1" data-bbox="893 1108 1268 1254"> <thead> <tr> <th>Location</th> <th>Resistance value</th> </tr> </thead> <tbody> <tr> <td>Red – White, Orange</td> <td>42-50 Ω</td> </tr> <tr> <td>Red – Yellow, Blue</td> <td>42-50 Ω</td> </tr> </tbody> </table> <p>Condition 20°C</p>	Location	Resistance value	Red – White, Orange	42-50 Ω	Red – Yellow, Blue	42-50 Ω										
	Location	Resistance value																
Red – White, Orange	42-50 Ω																	
Red – Yellow, Blue	42-50 Ω																	
	Type UKV-A038 (1102,1402H-E)	<p>1 Black 6 Gray 3 Red</p>  <table border="1" data-bbox="893 1400 1268 1545"> <thead> <tr> <th>Location</th> <th>Resistance value</th> </tr> </thead> <tbody> <tr> <td>Grey – Black, Red</td> <td>43-49 Ω</td> </tr> <tr> <td>Grey – Yellow, Orange</td> <td>43-49 Ω</td> </tr> </tbody> </table> <p>Condition 20°C</p>	Location	Resistance value	Grey – Black, Red	43-49 Ω	Grey – Yellow, Orange	43-49 Ω										
Location	Resistance value																	
Grey – Black, Red	43-49 Ω																	
Grey – Yellow, Orange	43-49 Ω																	
5	Suction temperature (TS) sensor Heat exchange temperature (TE) sensor Outdoor temperature (TO) sensor	<p>Remove the connector and measure the resistance value with a tester. 10-20 kΩ (Normal temperature)</p> <table border="1" data-bbox="542 1713 1428 1870"> <thead> <tr> <th></th> <th colspan="4">Temperature</th> </tr> <tr> <th>Sensor (kΩ)</th> <th>0°C</th> <th>10°C</th> <th>20°C</th> <th>30°C</th> </tr> </thead> <tbody> <tr> <td>Outdoor heat exchange temperature sensor (TE)</td> <td rowspan="2">33.8</td> <td rowspan="2">20.4</td> <td rowspan="2">12.6</td> <td rowspan="2">8.0</td> </tr> <tr> <td>Suction temperature sensor (TS)</td> </tr> </tbody> </table>		Temperature				Sensor (kΩ)	0°C	10°C	20°C	30°C	Outdoor heat exchange temperature sensor (TE)	33.8	20.4	12.6	8.0	Suction temperature sensor (TS)
	Temperature																	
Sensor (kΩ)	0°C	10°C	20°C	30°C														
Outdoor heat exchange temperature sensor (TE)	33.8	20.4	12.6	8.0														
Suction temperature sensor (TS)																		
6	Discharge temperature (TD) sensor	<p>Remove the connector and measure the resistance value with a tester.</p> <table border="1" data-bbox="542 1948 1428 2060"> <thead> <tr> <th></th> <th colspan="4">Temperature</th> </tr> <tr> <th>Sensor (kΩ)</th> <th>0°C</th> <th>10°C</th> <th>20°C</th> <th>30°C</th> </tr> </thead> <tbody> <tr> <td>Discharge temperature sensor (TD)</td> <td>161.3</td> <td>99.0</td> <td>62.4</td> <td>40.2</td> </tr> </tbody> </table>		Temperature				Sensor (kΩ)	0°C	10°C	20°C	30°C	Discharge temperature sensor (TD)	161.3	99.0	62.4	40.2	
	Temperature																	
Sensor (kΩ)	0°C	10°C	20°C	30°C														
Discharge temperature sensor (TD)	161.3	99.0	62.4	40.2														

10 Hydro unit and Outdoor Unit Settings

Hydro unit

1. Hydro unit Setting

1-1. Setting switch names and positions

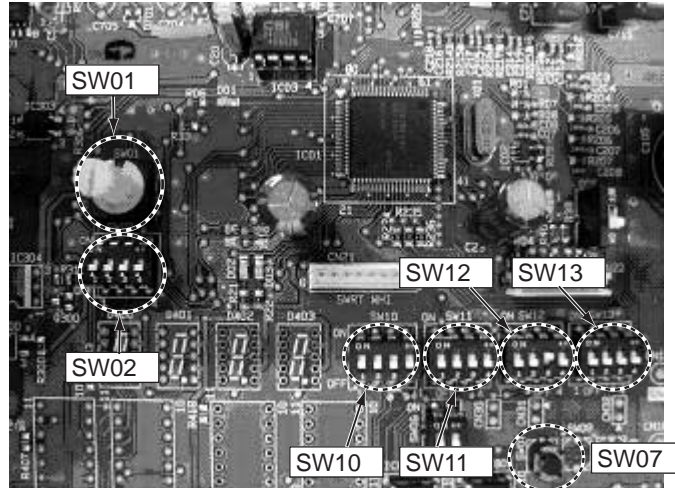

1-2. SW02 (System switching 1)

SW02	Switching details	Factory setting		Remarks
02_1	–	–	OFF	
02_2	–	–	OFF	
02_3	–	–	OFF	
02_4	Room thermostat	No	OFF	

1-3. SW10 (Pump switching)

SW10	Switching details	Factory setting		Remarks
10_1	–	–	OFF	
10_2	–	–	OFF	
10_3	Enhanced pump2 Interlock Yes/No	Yes	OFF	
10_4	–	–	OFF	

1-4. SW11 (Heater Yes/No switching)

SW11	Switching details	Factory setting		Remarks
11_1	Internal backup heater Energized Yes/No	Energized	OFF	
11_2	Hot water cylinder heater Energized Yes/No	Energized	OFF	
11_3	Booster heater Energized Yes/No	Energized	OFF	
11_4	–	–	OFF	

1-5. SW12 (System switching 2)

SW12	Switching details	Factory setting		Remarks
12_1	Hot water supply	Yes	OFF	
12_2	ZONE1	Yes	OFF	
12_3	ZONE2	No	OFF	
12_4	–	–	OFF	











1-6. SW13 (System switching 3)

SW13	Switching details	Factory setting		Remarks
13_1	3WV SPST/SPSD Specification switching	SPST	OFF	
13_2	Boiler placement	No	OFF	
13_3	Auto Restart of power outage	Yes	OFF	
13_4	–	–	OFF	

2. Hydro unit Function Code Setting

2-1. How to set function code

<Procedure> Perform the following when no operation is in progress.



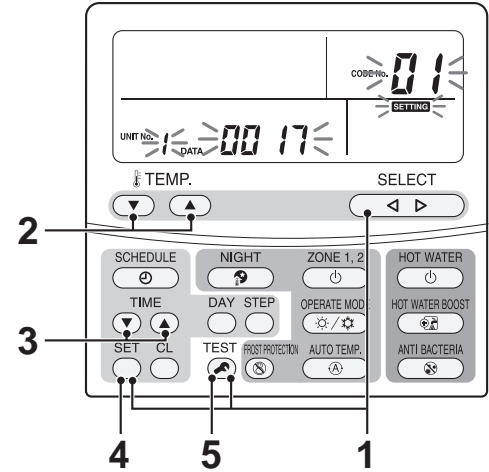







- 1 Press the SET  and TEST  and SELECT  buttons at the same time for 4 seconds or longer.
(See display )
- 2 Specify CODE NO. (FC) with the TEMP.   button for temperature setting.
- 3 Select a setting data with the TIME   button for timer setting.
The value in the DATA item changes.
- 4 Press the SET  button. (If  lights, the status is confirmed)
To change the item to be set, go to 2.
- 5 Pressing the TEST  button moves the unit to the normal stop state.



2-2. How to set remote controller function code

This operation can set the start and end time of the nighttime low noise, anti bacteria, night set back, or other functions.

<Procedure> Perform the following when no operation is in progress.

- 1 Press the TEST  and CL  and TEMP.  buttons at the same time for 4 seconds or longer. (See display )
 appears on the left.
- 2 Specify CODE NO. (FC) with the TEMP.   button for temperature setting.
- 3 Select a setting data with the TIME   button for timer setting.
The value in the DATA item changes.
- 4 Press the SET  button. (If the blinking changes to lit, the status is normal)
To change the item to be set, go to 2.
- 5 Pressing the TEST  button moves the unit to the normal stop state.

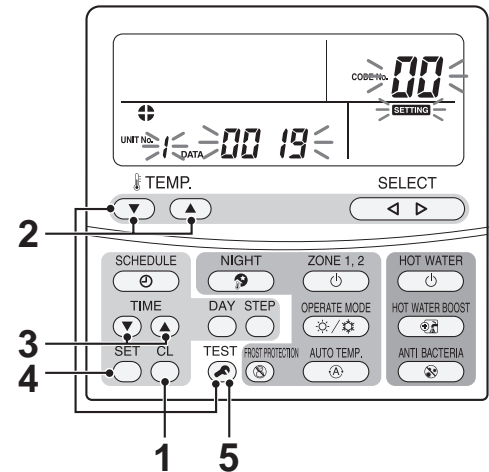

Function code table

FC	Item	Details		First shipment
01	Water heat exchanger capacity	0012: 802XWH**-E 0017: 1402XWH**-E		Depends on type
02	Cooling/Non-cooling switching	0000: Cooling	0001: No cooling	0001: No cooling
07	Hot water HP operation mode upper time limit	0000: 0 mins	- 0120: 120 mins	0030: 30 mins
08	Hot Water Boost operation time	0003: 30 mins	- 0018: 180 mins	0006: 60 mins
09	Hot Water Boost set temperature	0040: 40°C	- 0080: 80°C	0075: 75°C
0A	Anti bacteria set temperature	0070: 70°C	- 0080: 80°C	0075: 75°C
0B	Anti bacteria holding time	0000: 0 mins	- 0060: 60 mins	0030: 30 mins
0C	Mixing valve drive time	0003: 30 secs	- 0024: 240 secs	0006: 60 secs
18	Upper limit of cooling set temperature	0018: 18°C	- 0030: 30°C	0025: 25°C
19	Lower limit of cooling set temperature	0010: 10°C	- 0018: 18°C	0010: 10°C
1A	Upper limit of heating (ZONE1) set temperature	0037: 37°C	- 0055: 55°C	0055: 55°C
1B	Lower limit of heating (ZONE1) set temperature	0020: 20°C	- 0037: 37°C	0020: 20°C
1C	Upper limit of heating (ZONE2) set temperature	0037: 37°C	- 0055: 55°C	0055: 55°C
1D	Lower limit of heating (ZONE2) set temperature	0020: 20°C	- 0037: 37°C	0020: 20°C
1E	Upper limit of hot water set temperature	0060: 60°C	- 0080: 80°C	0075: 75°C
1F	Lower limit of hot water set temperature	0040: 40°C	- 0060: 60°C	0040: 40°C
20	Hot water HP start temperature	0020: 20°C	- 0045: 45°C	0038: 38°C
21	Hot water HP stop temperature	0040: 40°C	- 0050: 50°C	0045: 45°C
22	Priority mode Hot water supply/Heating switching temperature	-0020: -20°C	- 0020: 20°C	0000: 0°C
23	Priority mode Boiler/Heat pump switching temperature	-0020: -20°C	- 0020: 20°C	-0010: -10°C
24	Outside air temperature for hot water temperature correction start	-0020: -20°C	- 0010: 10°C	0000: 0°C
25	Hot water temperature correction value	0000: 0K	- 0015: 15K	0003: 3K
26	Night set back change temperature range	0003: 3K	- 0020: 20K	0005: 5K
27	Set temperature shift with heating Auto	-0005: -5K	- 0005: 5K	0000: 0K
29	Outside air temperature T1 temperature	-0015: -15°C	- 0000: 0°C	-0010: -10°C
2B	Outside air temperature T3 temperature	0000: 0°C	- 0015: 15°C	0010: 10°C
2C	Set temperature A with outside air temperature of -20°C	0020: 20°C	- 0055: 55°C	0040: 40°C
2D	Set temperature B with outside air temperature of T1	0020: 20°C	- 0055: 55°C	0035: 35°C
2E	Set temperature C with outside air temperature of 0°C	0020: 20°C	- 0055: 55°C	0030: 30°C
2F	Set temperature D with outside air temperature of T3	0020: 20°C	- 0055: 55°C	0025: 25°C
30	Set temperature E with outside air temperature of 20°C	0020: 20°C	- 0055: 55°C	0020: 20°C
31	Zone2 ratio with Zone1 as Auto	0000: 0%	- 0100: 100%	0080: 80°C
33	Heater control down time	0000: 5 mins 0002: 15 mins	0001: 10 mins 0003: 20 mins	0001: 10 mins
34	Heater control up time	0000: 10 mins 0002: 30 mins	0001: 20 mins 0003: 40 mins	0000: 10 mins
3A	Frost protection function Yes/No	0000: No	0001: Yes	0001: Yes
3B	Frost protection set temperature	0010: 10°C	- 0020: 20°C	0015: 15°C
3C	Water 2-way energization (logical reverse) control	0000: No	0001: Yes (Reverse)	0000: No
3E	Heating HP/Boiler priority switching when using boiler	0000: Priority on HP	0001: Priority on boiler	0000: Priority on HP

Remote controller function code table

FC	Item	Details	Fist shipment
05	24H/12H display switching	0: 24H display 1: 12H (AM/PM) display	0: 24H display
09	Nighttime low-noise mode	0: Disabled 1: Enabled	0: Disabled
0A	Nighttime low-noise start time	0 - 23 (0:00 to 23:00)	22: 22:00
0B	Nighttime low-noise end time	0 - 23 (0:00 to 23:00)	06: 06:00
0C	Anti bacteria start time	0 - 23 (0:00 to 23:00)	22: 22:00
0D	Anti bacteria start cycle	1 - 10 (Every day to 10-day cycle)	07: 7-day cycle
0E	Night operation start time	0 - 23 (0:00 to 23:00)	22: 22:00
0F	Night operation end time	0 - 23 (0:00 to 23:00)	06: 06:00
11	Remote control Alarm Tone.	0: Alarm Tone OFF 1: Alarm Tone ON	1: Alarm Tone ON



3. Trial Operation

<Procedure>

A trial operation is available with an actual operation in progress or stopped. A trial operation is available in any of the hot water supply, heating, or cooling mode. The compressor starts according to the trial operation frequency. A trial operation automatically stops after 30 minutes at the longest if not stopped with the remote controller.

- 1 Press the remote controller TEST  button for 4 seconds or longer to display "TEST" on the LCD screen.

<For hot water supply trial operation>

- 2 Press the HOT WATER  button, and a hot water supply operation starts after 3 minutes. (See display )
(The pump immediately starts.)
- 3 Pressing the HOT WATER  button again stops the hot water supply operation.

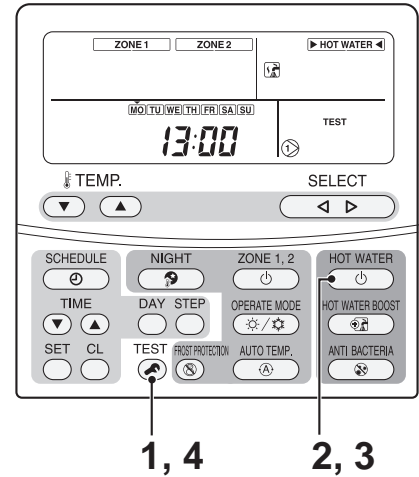



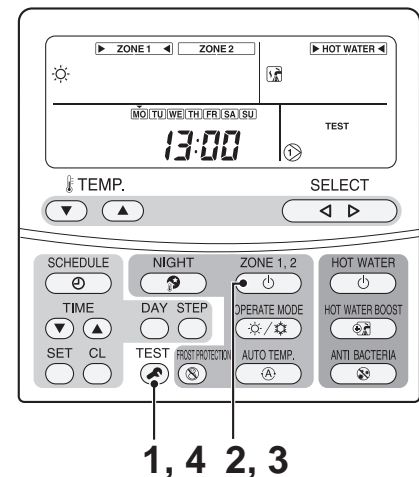

<For heating trial operation>

- 1 Press the ZONE1,2  button, and a heating operation starts after 3 minutes. (See display )
(The pump immediately starts.)
- 2 Pressing the ZONE1,2  button again stops the heating operation.



<For cooling trial operation>

- 2 Press the ZONE1,2  button and then OPERATE MODE , and a cooling operation starts after 3 minutes. (The pump immediately starts.) (See display )
- 3 Pressing the ZONE1,2  button again stops the cooling operation.

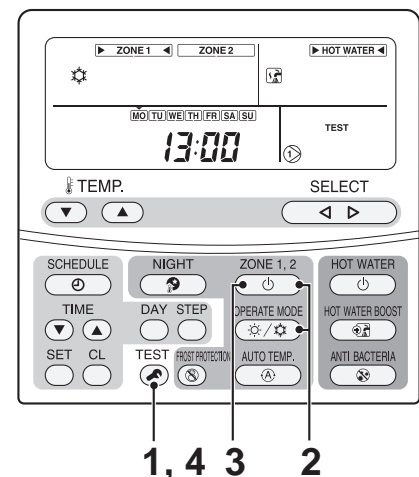

- 4 Press TEST  on the remote controller to exit the trial operation mode.

4. Auto Curve Setting

FC code setting can make flexible Auto-Curve settings.

<Preparation>

- 1 Press the **TEST** (👉) and **SET** (○) and **SELECT** (◀▶) buttons at the same time for 4 seconds or longer. (See display 👉)
(Make sure that no operation is in progress.)
- 2 Specify an item code (FC) from among 29 to 2F with the **TEMP.** (▼) (▲) button for temperature setting.
- 3 Set data with the **TIME** (▼) (▲) button for timer setting.
- 4 Press the **SET** (○) button. (If **OK** lights, the status is confirmed)
- 5 Repeat 2 through 4 for each item.
- 6 Pressing the **TEST** (👉) button moves the unit to the normal stop state.

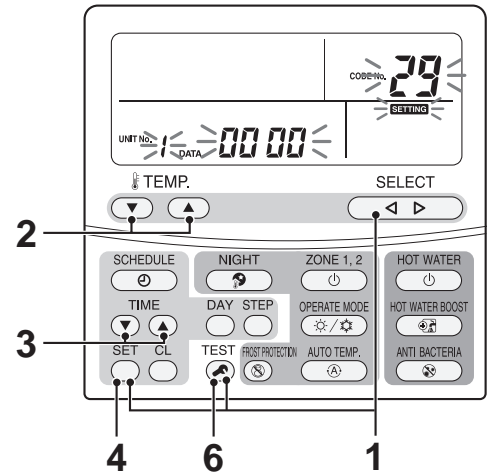

FC	Item	Details	Fist shipment
29	Outside air temperature T1 temperature	-0015: -15°C	-0010: -10°C
2B	Outside air temperature T3 temperature	0000: 0°C	0010: 10°C
2C	Set temperature A with outside air temperature of -20°C	0020: 20°C	0040: 40°C
2D	Set temperature B with outside air temperature of T1	0020: 20°C	0035: 35°C
2E	Set temperature C with outside air temperature of 0°C	0020: 20°C	0030: 30°C
2F	Set temperature D with outside air temperature of T3	0020: 20°C	0025: 25°C
30	Set temperature E with outside air temperature of 20°C	0020: 20°C	0020: 20°C
31	Zone2 ratio with Zone1 as Auto	0000: 0%	0080: 80%

TSC-F

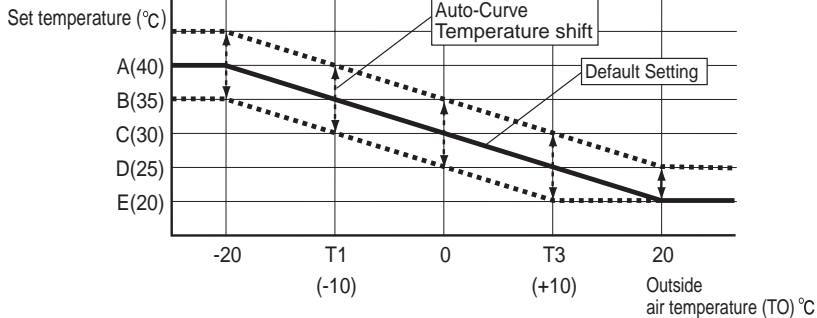







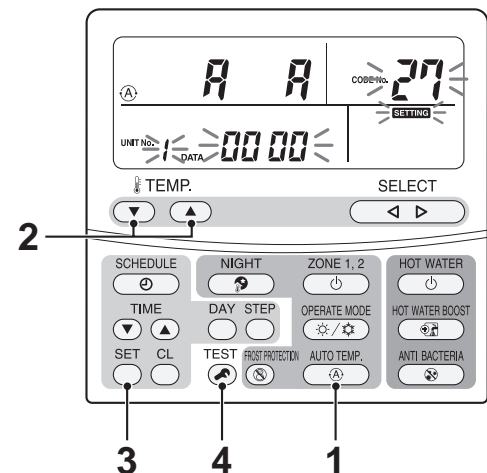



• Auto-Curve temperature shift

Without Auto-Curve individually set, the set temperature can be shifted in the range of $\pm 5k$ of the current setting. (The set temperature is valid only when Auto operation is in progress.)

- 1 Press the **AUTO TEMP** (A) button for 4 seconds or longer. (See display 👉)
(The remote controller FC setting screen appears.)
- 2 Set a temperature shift range with the **TEMP.** (▼) (▲) button for temperature setting. (-5k to 5k)
- 3 Press the **SET** (○) button. (If **OK** lights, the status is confirmed)
- 4 Pressing the **TEST** (👉) button moves the unit to the normal stop state.



5. Time Setting

- 1 Press the TIME  button for 4 seconds or longer. (The screen moves to the time setting mode.) (See display )**
Day, time, , and **SETTING** indications blink.
(Time setting is available during an operation.)
- 2 Specify a day to be set.**
Press the DAY  button to select the current day.
The  symbol moves along above the days. ( moves by each button press from MO through SU.)
- 3 Set time.**
Use the TIME   button to set time. Long press changes time display by 10 minutes.
- 4 Pressing the SET  button ends the time setting. Ending the time setting changes the days and time to the lit state and returns to the normal display.**
 and **SETTING** indications go out.)

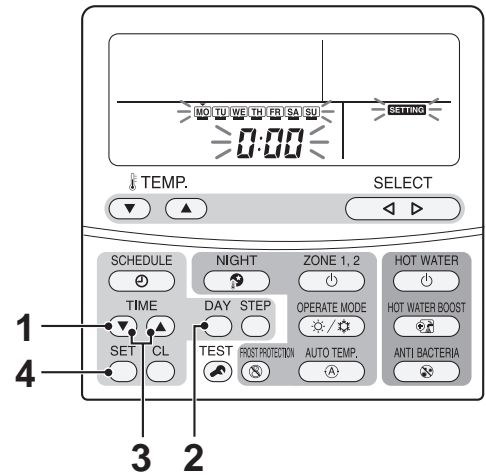

6. Scheduled Operation Setting

Schedule setting makes the following modes to be flexibly set: hot water supply, heating, cooling, hot water supply and heating, hot water supply and cooling, and stop, and set temperature.

6-1. How to set scheduled operation

<Preparation>



Set the remote controller time.

1 Press the remote controller SCHEDULE button for 4 seconds or longer. (See display)

(Moves to the schedule setting mode)

The following blink: **SETTING**, , and P1 indications, items to be set, the set temperature of ZONE1/2 and HOT WATER (previous set temperature), **STEP** / day (**MO**|**TU**|**WE**|**TH**|**FR**|**SA**|**SU**), and time **0:00**.

2 Specify a day to be set.

Press the DAY  button to move day  to the day to be set. ( moves by each button press from MO through SU. From SU, the symbol moves to MO through SU (Every day).

Press the SET  button to confirm the day to be set.

3 Specify a step from among steps 1 to 8.

Press the STEP  button to specify a step to be set.

(The selection moves by each STEP  button press among 1 to 8, C, and L.)









Selecting "C" copies the day details already set. Go to **7**.

Selection "L" clears the setting details.

Press the SET  button to confirm the step to be set.

4 Specify set time, operation mode, and set temperature.

Time setting: Use the TIME  button to set time.

Operation mode: Press HOT WATER  for hot water supply, ZONE1,2  for heating, or ZONE1,2  for cooling, and then press OPERATE MODE . Pressing HOT WATER  or ZONE1,2  again displays "---", indicating stop. When an operation mode is set, "" appears for heating, "" for cooling, or "" for hot water supply, and also the temperature set last time is displayed.

Temperature setting: Use the SELECT  button to select a mode  and set temperature with the TEMP.  button.

Press the SET  button to confirm the set time, operation mode, and set temperature to be set.



5 Repeat 2 through 4.

(If only one schedule is set, the setting applies to all the time period after the set time. Two schedule settings are recommended.)

6 Pressing the SCHEDULE button ends the schedule setting. Ending the schedule setting blinks the light . Pressing the SET button during the 5-second blinking changes to lit, and the schedule operation starts.

7 How to copy program

Select "C" in **3** and press the SET  button. (Copy source is determined.)



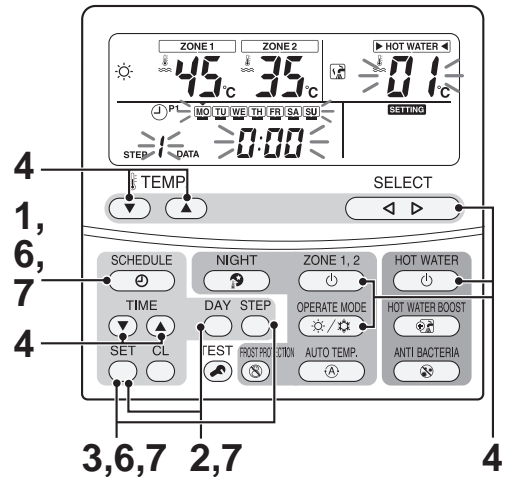

Press the DAY  button to move  to the day of copy target. Pressing the SET  button overwrites the program setting to the copy target.

To set more, repeat step **2** through **4**. Pressing the SCHEDULE  button ends the schedule setting.







6-2. How to start and cancel schedule operation

<Operation start>







Without schedule operation set, press the remote controller SCHEDULE  button.  blinks.
Pressing the SET  button during the 5-second blinking changes  to lit, and the schedule operation starts.

<Operation cancel>

With schedule operation set, press the remote controller SCHEDULE  button.  blinks.
Pressing the CL  button during the 5-second blinking causes  to put out, and the schedule operation is cancelled.

7. Frost Protection Setting





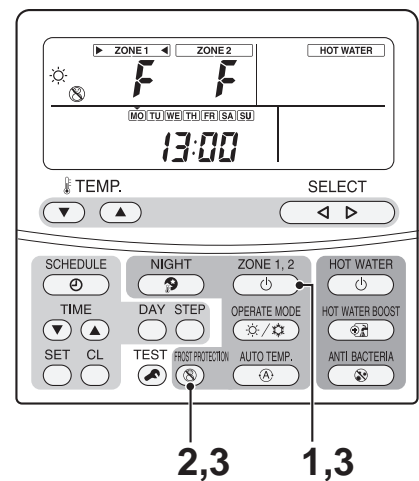

This setting keeps a room with weak heating when users are not home for long hours.

- 1 Press the ZONE1,2  button to start a heating operation.**
(This is available only for a normal heating operation.)
(No frost protection setting is provided to hot water supply and cooling.)
- 2 Pressing the FORST PROTECTION  button displays the  symbol and "F" for temperature setting. (See display )**
The heating operation of 15°C is set. In FC_3B in 2-2 section, the set temperature can be changed in the range of 10 to 55°C.
- 3 Pressing the FORST PROTECTION  button makes  disappear, and the set temperature returns to the normal heating temperature. (Pressing the ZONE1,2  button ends both the frost protection and the heating operation.)**









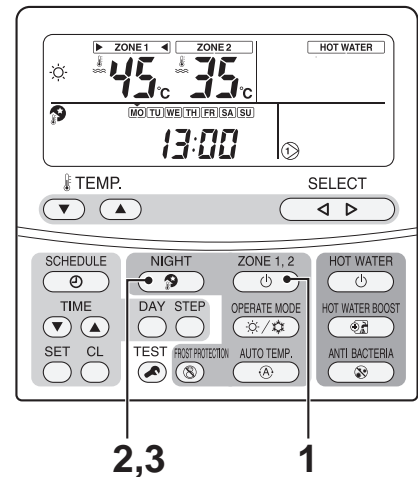



8. NIGHT Operation Setting

For nighttime hours, this setting changes set temperature of heating or cooling by 5k as save operation.

- 1 Press the ZONE1,2  button to start a heating or a cooling operation. (See display )
(Nighttime operation is not available for hot water supply. Use the schedule operation.)
- 2 Pressing the NIGHT  button displays the  symbol.
A nighttime operation lowers the set temperature by 5K for heating and raises 5K for cooling during the set time period (*1) from 22:00 to 6:00 (Default).
- 3 Pressing the NIGHT  button again makes  disappear, and the normal operation starts.







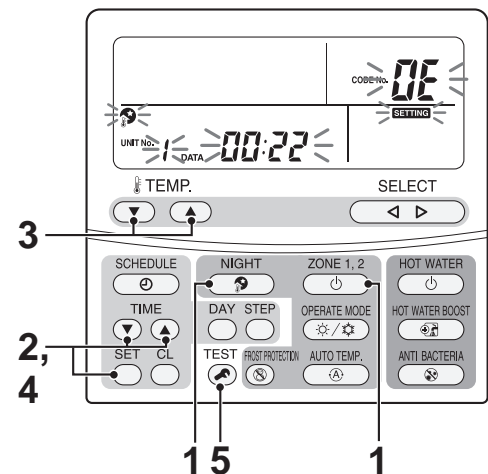

<How to set NIGHT operation start and end time>

- 1 Press the NIGHT  button for 4 seconds or longer.
(Moves to the NIGHT time setting mode) (See display )
"0E" in the Code No. field and the current time displayed blink.
- 2 Press the TIME   button to set a desired start time.
Pressing SET  changes the time to be lit and the setting is confirmed.
- 3 Press the TEMP.   button to change Code No.
(The codes "0E" and "0F" only can be changed.)
- 4 Press the TIME   button to set a desired end time.
Pressing SET  changes the time to be lit and the setting is confirmed.
- 5 Press the TEST  button to exit the NIGHT time setting mode.



9. Anti Bacteria Setting

This setting regularly raises the hot water cylinder temperature to prevent bacteria from growing.

- 1 Press the **HOT WATER**  button to start a hot water supply operation.
(Normal hot water supply operation)
(No anti bacteria setting is provided to heating and cooling.)
- 2 Pressing the **ANTI BACTERIA**  button displays the  symbol. (See display )
(The set temperature does not change) The hot water supply operation of 75°C starts.
The anti bacteria operation raises water temperature to 75°C with the heat pump and heater, and automatically ends after 30 minutes.
- 3 After that, an anti bacteria operation automatically starts at the set time and cycle.
- 4 Pressing the **ANTI BACTERIA**  button makes  disappear, and the anti bacteria operation does not start.

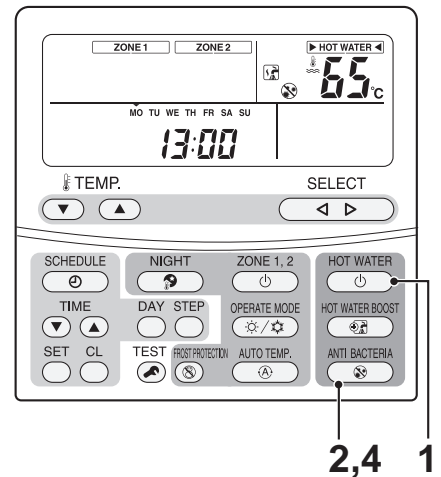













<How to set anti bacteria temperature and holding time>

In FC_0A or 0B (See 2-2), the set temperature and holding time can be changed.

FC_0A: Set temperature change range 70 to 80°C (75°C: default)

FC_0B: Holding time change range 0 to 60 minutes (30 minutes: default)



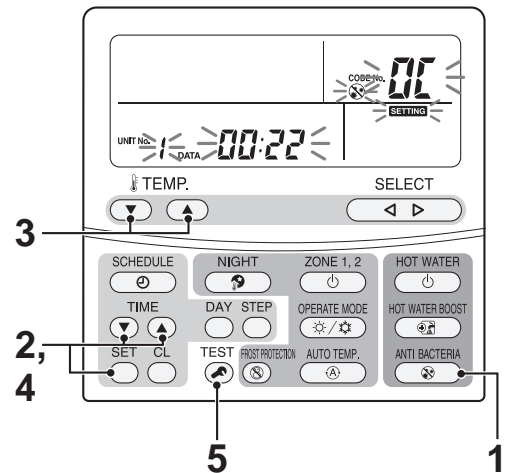

<How to set anti bacteria start time and cycle>

- 1 Press the **ANTI BACTERIA**  button for 4 seconds or longer. (See display )
(Moves to the anti bacteria time setting mode)
"0C" in the Code No. field and the currently set  and **SETTING** indication blink.
- 2 Press the **TIME**   button to set a desired start time.
Pressing SET  changes DATE (set time) 0C, and **SETTING** indication to be lit and the setting is confirmed.
- 3 Press the **TEMP.**   button to change Code No. to "0d".
The "0d" and **SETTING** indication blink.
- 4 Press the **TIME**   button to set a desired cycle.
Pressing SET  changes DATE (set time) 0d, and **SETTING** indication to be lit and the setting is confirmed.
- 5 Press the **TEST**  button to exit the anti bacteria time setting mode.



10. Hot Water Boost Setting

This setting heats the water whenever necessary by using the heat pump and hot water cylinder heater.

- 1 Press the **HOT WATER**  button to start a hot water supply operation.
(Normal hot water supply operation)
- 2 Pressing the **HOT WATER BOOST**  button displays the  symbol. (See display )
(The set temperature does not change) The hot water supply operation of 75°C starts.

HOT WATER BOOST operation with the heat pump and heater ends when the water temperature reaches 75°C; however, the normal hot water supply operation automatically starts after 60 minutes even if the temperature is not as high as 75°C.

- 3 Pressing the **HOT WATER BOOST**  button again makes  disappear, and the **HOT WATER BOOST** ends.

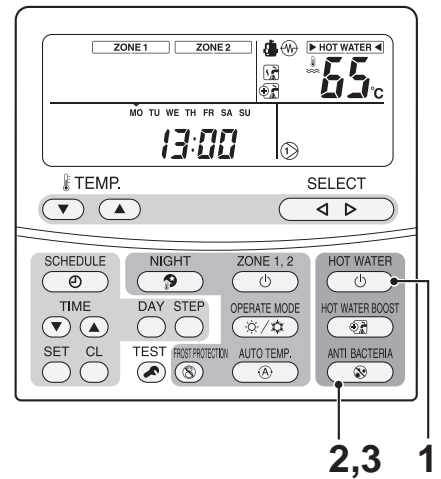

<How to set HOT WATER BOOST operation time and temperature>

In FC_08 or 09 (See 2-2), the operation time and set temperature can be changed.



















FC_08: Operation time change range 30 to 120 minutes (60 minutes: default)

FC_09: Set temperature change range 40 to 80°C (75°C: default)

11. Nighttime Low-noise Setting

- This setting is used to reduce noise output, from the outdoor unit, during nighttime for neighbours. Nighttime low-noise operates with lower operation frequency and fan tap than usual only for the set time period.
- The operation is the same as usual hot water supply, heating, or cooling.
- Adjust the unit time before making the settings.

<How to enable, set start time and end time of nighttime low-noise>



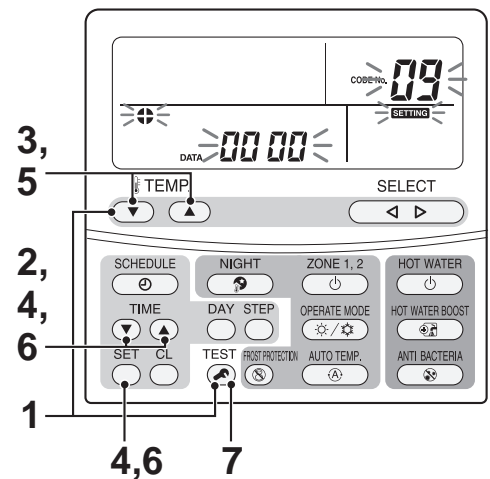







- 1 Press the **TEST**  and **TEMP.**  button at the same time for 4 seconds or longer. (See display )
(Moves to the nighttime low-noise setting mode)
"09" displayed in the Code No. field and the DATA currently displayed, **SETTING**, and  blink.
- 2 Press **TIME**   to set enabled "1" or disabled "0".
Pressing **SET**  changes DATA and **SETTING** indication to be lit and the setting is confirmed. (For DATA, only 1 or 0 can be selected.)
- 3 Press the **TEMP.**   button to change Code No. to "0A". DATA and **SETTING** indication again blink.
- 4 Press the **TIME**   button to set start time. Pressing **SET**  changes DATA and **SETTING** indication to be lit and the setting is confirmed.
- 5 Press the **TEMP.**   button to change Code No. to "0B". DATA and **SETTING** indication again blink.
- 6 Press the **TIME**   button to set end time. Pressing **SET**  changes DATA and **SETTING** indication to be lit and the setting is confirmed.
- 7 Press **TEST**  to exit the nighttime low-noise time setting mode. **SETTING** and  indications go out.



12. Forced Defrosting Setting

The FC code setting (See 2-2) can activate the forced defrosting mode for the outdoor unit operation.

(Preparation)

- 1** Press the remote controller buttons, TEST , SET , and SELECT , at the same time for 4 seconds or longer. (Make sure that no operation is in progress.)
- 2** Specify CODE NO. (FC) 46 with the TEMP.   button for temperature setting.
- 3** Set DATA to 0001 with the TIME   button for timer setting. (See display )
(Factory setting is 0000)
- 4** Press the SET  button. (If OK  lights, the status is normal)
- 5** Pressing the TEST  button moves the unit to the normal stop state.

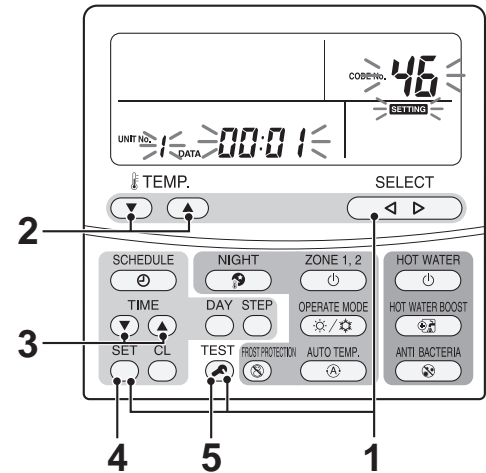











(Operation)

- Press the ZONE1,2  button.
- Set the operation to the heating mode.
- After a while, forced defrosting signals are transmitted to the outdoor unit, and the unit starts defrosting. (Forced defrosting lasts for up to 10 minutes.)
- After the defrosting, the heating operation starts.
- To perform defrosting again, start with **1** above.
(Performing the forced defrosting once cancels the forced defrosting setting above described.)

13. Rated Operation Setting

The FC code setting (See 2-2) can activate the rated operation mode during a heating operation.

(Preparation)

- 1** Press the remote controller buttons TEST , SET , and SELECT , at the same time for 4 seconds or longer. (Make sure that no operation is in progress.)
- 2** Specify CODE NO. (FC) 91 with the TEMP.   button for temperature setting.
- 3** Set DATA to 0001 with the TIME   button for timer setting. (See display )
(Factory setting is 0000)
- 4** Press the SET  button. (If OK  lights, the status is confirmed)
- 5** Pressing the TEST  button moves the unit to the normal stop state.

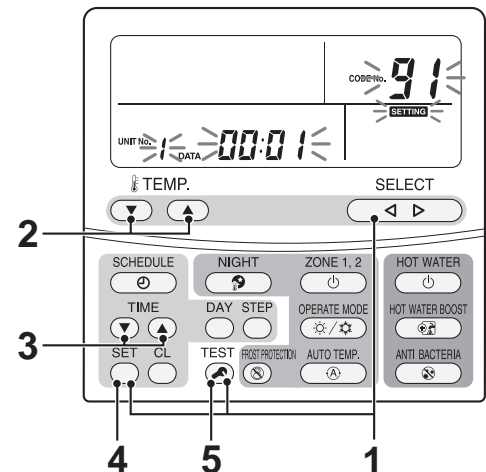

(Operation)

- Press the ZONE1,2  button.
- Set the operation to the heating mode.
- After a while the outdoor unit starts an operation with the rated operation frequency.
 - 3 horsepower: HWS-802XWH**-E/HWS-802H-E 66.0Hz
 - 4 horsepower: HWS-1402XWH**-E/HWS-1102H-E 44.4Hz
 - 5 horsepower: HWS-1402XWH**-E/HWS-1402H-E 56.4Hz





14. Display Function of Set Temperature and Other Settings

■ Sensor temperature display calling

<Details>

This function calls the service monitor mode from the remote controller, the hydro unit, and outdoor unit to show the data of the remote controller, the hydro unit, and outdoor unit.

<Procedure>

- 1 Press the TEST  and CL  buttons at the same time for 4 seconds or longer to call the service monitor mode. The service monitor lights up, and the temperature of CODE No. "00" displays at first. (See display )
- 2 Press the TEMP.   button for temperature setting to change the item code to one to be monitored. The following table shows the item codes.

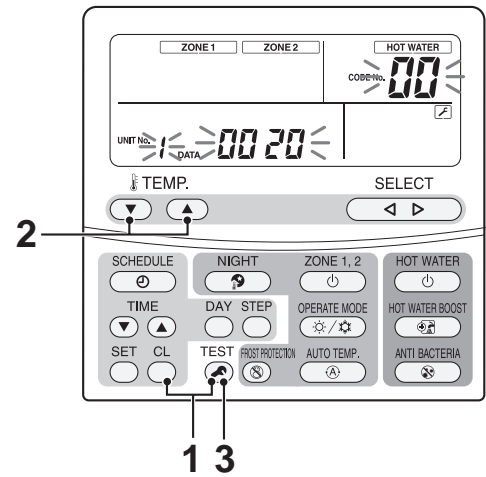

Hydro unit data	Item code	Data name	Unit
	00	Control temperature (Hot water cylinder)	°C
	01	Control temperature (Zone1)	°C
	02	Control temperature (Zone2)	°C
	03	Remote controller sensor temperature	°C
	04	Condensed temperature (TC)	°C
	06	Water inlet temperature (TWI)	°C
	07	Water outlet temperature (TWO)	°C
	08	Water heater outlet temperature (THO)	°C
	09	Floor inlet temperature (TFI)	°C
	0A	Hot water cylinder temperature (TTW)	°C
	0B	Mixing valve position	step
	0E	Lo pressure (Ps) × 100	MPa

Outdoor unit data	Item code	Data name	Unit
	60	Heat exchange temperature (TE)	°C
	61	Outside air temperature (TO)	°C
	62	Discharge temperature (TD)	°C
	63	Suction temperature (TS)	°C
	65	Heat sink temperature (THS)	°C
	6A	Current	A
	6D	Heat exchanger coil temperature (TL)	°C
	70	Compressor operation Hz	Hz
	72	Number of revolutions of outdoor fan (lower)	rpm
	73	Number of revolutions of outdoor fan (upper)	rpm
	74	Outdoor PMV position × 1/10	pls

Service data	Item code	Data name	Unit
	F0	Micro computer energized accumulation time	× 100h
	F1	Hot water compressor ON accumulation time	× 100h
	F2	Cooling compressor ON accumulation time	× 100h
	F3	Heating compressor ON accumulation time	× 100h
	F4	Built-in AC pump operation accumulation time	× 100h
	F5	Hot water cylinder heater operation accumulation time	× 100h
	F6	Backup heater operation accumulation time	× 100h
F7	Booster heater operation accumulation time	× 100h	

- 3 Pressing the TEST  button returns to the usual display.

15. Failure History Calling Function



<Details>

This function calls the previous failure details.

<Procedure>

- 1 Press the TEST  and SET  buttons at the same time for 4 seconds or longer to call the service check mode.**

The service check lights up with CODE No. "01" displayed at first, and the latest warning detail is displayed. The warning details of the current warning is displayed. (See display )

- 2 To monitor other failure history, press the TEMP.   button for temperature setting to change the failure history number (item code).**

Item code "01" (Latest) ---> Item code "01" (Old)

Note: The failure history contains the last 4 failures.

- 3 Pressing the TEST  button returns to the normal display.**

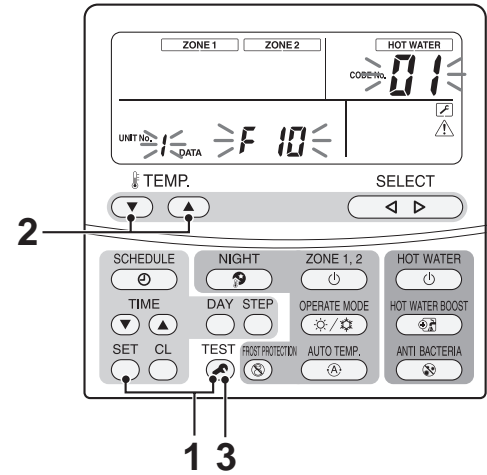

<Notes>

Do not press the CL  button. Pressing the button deletes all the failure history of the hydro unit.

If the button is pressed and the history is deleted, perform power cycle.

If the current failure is the same as the one occurred last time before deleted, the history may not record the current failure.

Outdoor unit

16 Outdoor Unit Setting

16-1. Refrigerant recovery control

Although HFC refrigerant is "Ozone depletion potential = 0", emission control is applied to it as a greenhouse effect gas.

This model has a switch for the outdoor unit to perform an environment-friendly refrigerant recovery operation (pump down) when the model is replaced or discarded.

[How to operate]

- 1 Remove the water in the hydro unit.**
(With the water remained in the hydro unit, performing refrigerant recovery may freeze the water and burst the unit.)
- 2 Set all the SW804 dip switches to OFF (initial status), and press the push-button switch SW801 for approx. 1 second.**
A cooling operation starts. (During the operation, D805 (green LED) blinks.
Note that this operation lasts for 10 minutes.
- 3 After 3 minutes has passed, close the liquid-side valve.**
- 4 After the refrigerant recovery is completed, close the gas-side valve.**
- 5 Press again the push-button switch SW801 for approx. 1 second. The outdoor unit stops operation (cooling).**

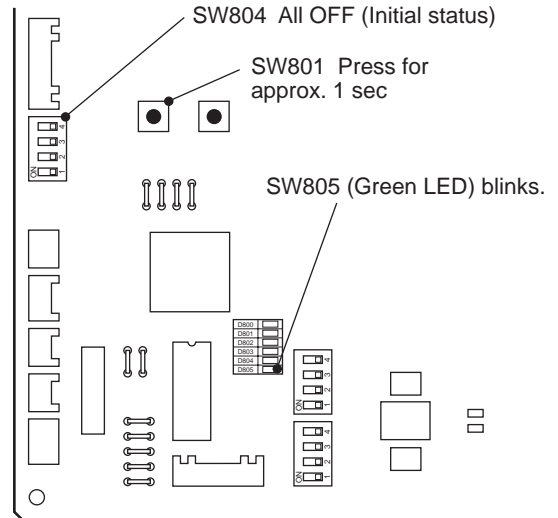

16-2. Outdoor unit settings (Existing piping, Power save, etc.)

The following settings are available with dip switch setting and jumper wire setting.

Function	Where to set	Control details																											
Existing piping setting	SW802 <input type="checkbox"/> --- OFF <input checked="" type="checkbox"/> --- Existing piping setting <input checked="" type="checkbox"/> --- Power save setting <input checked="" type="checkbox"/> --- Snow prevention fan control * All OFF position at factory setting	When using a Ø19.1 pipe for the existing piping, set the switch to ON. This case may decrease heating capacity depending on the outside air temperature when heating or on a room temperature.																											
Power save setting		When using the power save function, set the switch to ON. This setting controls the compressor frequency lowering (about 10%) according to the heat exchange temperature of the hydro unit during a heating or hot water supply operation.																											
Snow prevention fan control		This control enables the function that prevents snow from entering the draft air duct through the fan guard or a heat exchanger gap and causing moter lock. If the outside air temperature is 0°C below, this control operates the outdoor fan in W5 even if the compressor is not in operation.																											
Defrosting time change	J805, J806	If the defrosting interval is shorter than the standard, the jumper wire is cut. For the control details or how to cut the jumper wire, see defrosting control.																											
Maximum frequency change	J807	If the maximum value of compressor frequency need to be lowered, cut the jumper wire shown on the left. This control lowers the maximum frequency when hot water supply, heating, or cooling is in operation. (HWS-802H-E only) In this case, the maximum capacity decreases. Maximum frequency of compressor <table border="1" style="width: 100%; text-align: center;"> <thead> <tr> <th rowspan="2">Model</th> <th colspan="2">HWS-802H-E</th> <th colspan="2">HWS-1102H-E</th> <th colspan="2">HWS-1402H-E</th> </tr> <tr> <th>Cooling</th> <th>Heating</th> <th>Cooling</th> <th>Heating</th> <th>Cooling</th> <th>Heating</th> </tr> </thead> <tbody> <tr> <td>Standard</td> <td>70.2</td> <td>70.2</td> <td>60.0</td> <td>60.0</td> <td>70.2</td> <td>70.2</td> </tr> <tr> <td>J807 cut</td> <td>53.4</td> <td>64.2</td> <td>60.0</td> <td>60.0</td> <td>70.2</td> <td>70.2</td> </tr> </tbody> </table>	Model	HWS-802H-E		HWS-1102H-E		HWS-1402H-E		Cooling	Heating	Cooling	Heating	Cooling	Heating	Standard	70.2	70.2	60.0	60.0	70.2	70.2	J807 cut	53.4	64.2	60.0	60.0	70.2	70.2
Model	HWS-802H-E			HWS-1102H-E		HWS-1402H-E																							
	Cooling	Heating	Cooling	Heating	Cooling	Heating																							
Standard	70.2	70.2	60.0	60.0	70.2	70.2																							
J807 cut	53.4	64.2	60.0	60.0	70.2	70.2																							

16-3. Service support functions (LED indication, Switch operation method)

The following settings are available with dip switches.

(1) Overview

Using 3 dip switches (SW802, SW803, SW804) and 2 push-button switches (SW800, SW801) can make settings available and confirm operations.

For operation

Part number	Specification	Operation details
SW800	Press button switch	This switch switches the indications of LED (D800 to D804) on the outdoor control board.
SW803	Dip switch	
SW801	Press button switch	This switch enables users to perform a special operation for maintenance and inspection.
SW804	Dip switch	
SW802	Dip switch	This switch performs initial settings. (See 8-4-6)

For display

Part number	Specification	Operation details
D502	Amber LED	Signal display (signals from the hydro unit) of communication between hydro unit and outdoor unit (serial communication)
D503	Green LED	Signal display (signals from the outdoor unit) of communication between hydro unit and outdoor unit (serial communication)
D800 to D804	Yellow LED	Abnormality indication All OFF of SW803 or the lit status of any of D800 to D804 indicates that the outdoor control unit detects an abnormality. Setting SW803 to other than OFF shows details with LED indication.
D805	Green LED	Energization indication This LED lights when the outdoor unit is energized. During a special operation with the SW801 or SW804 operation, this LED blinks.

Note: All the LEDs have no color when off.

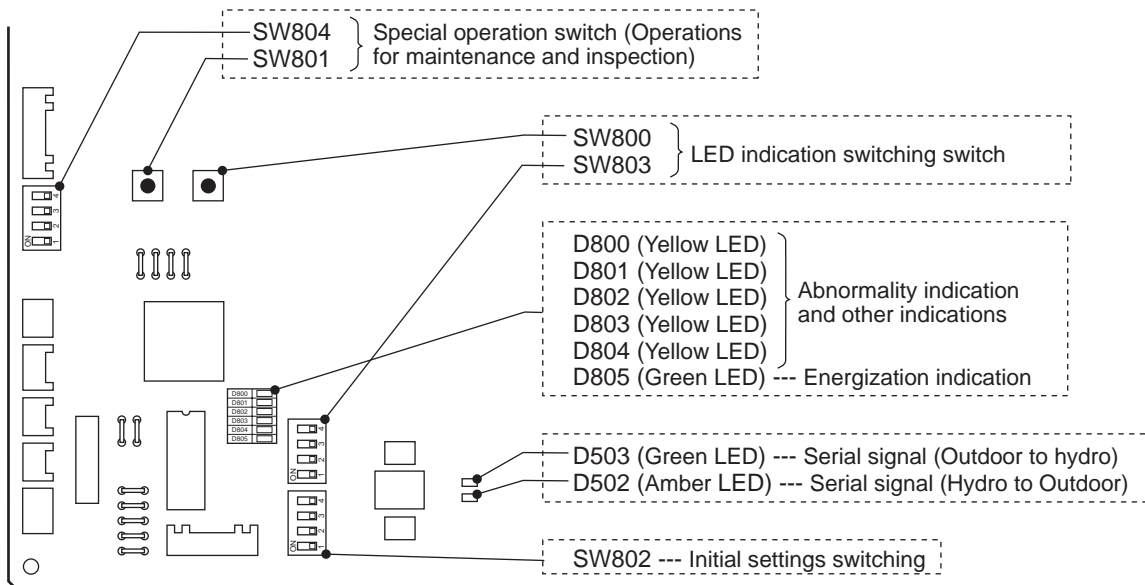

(2) LED indication switching (SW800, SW803 operation)

(2) -1. Indication switching list

Operating SW803 can switch the indications of LED D800 to D804 on the outdoor control board.

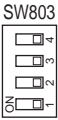
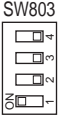
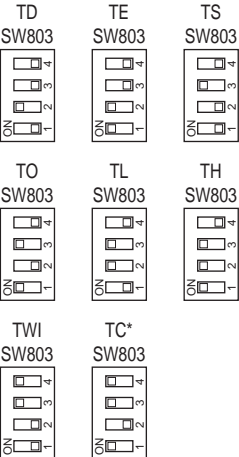
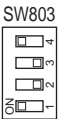
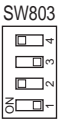
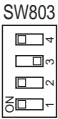
Switch	Function and details
	<p>Abnormality indication (Current abnormality) This switch indicates the current abnormality. Without an abnormality, the lights are off.</p> <p style="text-align: right;">(See (2)-2)</p>
	<p>Abnormal indication (Latest abnormality: Latest abnormality including the current one) After the abnormality status is released, this setting enables users to see the previous abnormalities. (Previous abnormality can be checked even if the power is once turned off.) * If there is an abnormality now, the abnormality details of the current one is displayed. * This setting does not display a TO sensor failure. (Check for the failure with the setting for current abnormality.)</p> <p style="text-align: right;">(See (2)-2)</p>
	<p>Temperature sensor indication These switches indicate the temperature sensor detecting value. * TC=TWO+2 (heating, hot water supply) TC=TWO (cooling)</p> <p style="text-align: right;">(See (2)-3)</p>
	<p>Current indication This switch indicates the current value in the outdoor unit.</p> <p style="text-align: right;">(See (2)-3)</p>
	<p>Compressor operation frequency indication This switch indicates the compressor operation frequency.</p> <p style="text-align: right;">(See (2)-3)</p>
	<p>PMV Openness indication This switch indicates PMV (Pulse motor valve) position.</p> <p style="text-align: right;">(See (2)-3)</p>

(2) -2. Abnormality indication

The current abnormality and the latest abnormality (including the current one) can be identified by the LED D800 to D804 on the outdoor control board.

- 1) Setting all the SW803 dip switches to OFF indicates the current abnormality status.
- 2) Setting SW803 dip switch <1> only to ON indicates the previous abnormality (including the current one).
- 3) An abnormality lights any of the LEDs from D800 to D804. (Indication 1)
- 4) Pressing the push-button switch SW800 for approx. 1 second switches indication. (Indication 2)
- 5) When SW800 is again pressed or 2 minutes has passed, the indication 1 status returns.

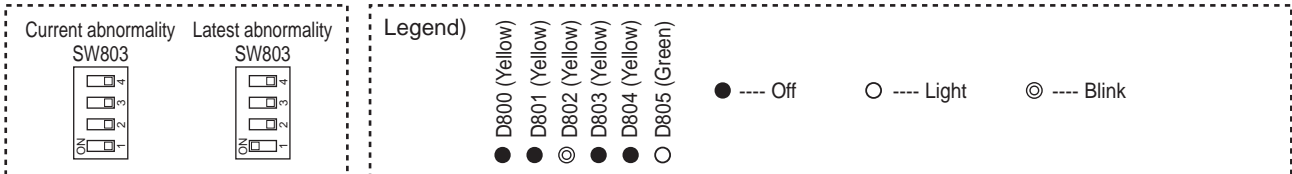









Indication 1 (Initial indication)	Indication 2 (SW800 operation)	Abnormality details	Remote controller Abnormality code
●●●●●○	●●●●●○	Normal	---
○○●●○○	●●◎●●○	Discharge temperature sensor (TD) failure	F04
	●◎◎●●○	Heat exchanger temperature sensor (TE) failure	F06
	◎◎◎●●○	Heat exchanger temperature sensor (TL) failure	F07, F06
	●●◎●●○	Outside air temperature sensor (TO) failure	F08
	●●◎◎●○	Suction temperature sensor (TS) failure	F12, F06
	◎●◎◎●○	Heat sink temperature sensor (TH) failure	F13, L29
	◎◎◎◎●○	Heat exchanger, suction sensor (TE, TS) wrong wiring	F15, F06
	◎◎◎◎◎○	EEPROM failure	F31, L29
●●○○●○○	◎●●●●○	Compressor break down	H01
	●◎●●●○	Compressor lock	H02
	◎◎●●●○	Current detection circuit failure	H03
	●●◎●●○	Faulty compressor case thermostat	H04, P04
●○○●○○	●◎●◎●○	Not set up the capacity	L10, L29
	◎●◎◎◎○	Communication failure between MCUs	L29
	◎◎◎◎◎○	Other abnormality (e.g. Compressor's loss of synchronism)	No abnormality confirmation
○○○●○○	◎◎●●●○	Abnormal discharge temperature	P03
	◎●◎●●○	Power failure	P05, H03, P04
	◎◎◎●●○	Heat sink overheat failure	P07, L29
	◎◎◎◎●○	Gas leakage detection	P15, L29
	◎◎●●◎○	4-way valve reverse failure	P19, L29
	●●◎◎◎○	Hi pressure protection operation	P20, P04
	●◎◎◎◎○	Fan drive system failure	P22
	●◎●◎◎○	Compressor drive	P26
	◎●◎◎◎○	Compressor rotor position failure	P29

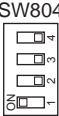





(3) Special operation for maintenance and inspection (SW801, SW804)

SW801 and SW804 can perform the following special operations for maintenance and inspection.

- 1) Switches the dip switch SW804. (See the table below)
- 2) Presses the push-button switch SW801 for approx. 1 second.
- 3) Starts the functions shown below. During the start processing of each function, LED D805 (Green) blinks.
- 4) When the push-button switch SW801 is pressed for approx. 1 second, or the dip switch SW804 is switched, or the defined time for each function has passed, the each function stops and LED D805 (Green) returns to continuous lit.

<Special operation>

SW804	Operation when press button switch SW801 is pressed	
	<p>Refrigerant recovery operation The outdoor unit operates cooling. The hydro unit may freeze with this operation alone. Remove beforehand the water in the hydro unit. (See 16-1)</p>	
	<p>Hydro unit cooling request Performs a trial cooling operation. (See Note1)</p>	
	<p>Hydro unit heating request Performs a trial heating operation.(See Note1)</p>	
	<p>Fan motor forcible operation Forcibly performs a fan motor operation. When SW801 is pressed again or after 2 minutes, the operation returns to the normal control.</p>	<p>Caution: Although these controls are available during an operation, basically perform them when no operation is in progress. Performing these controls during an operation may cause dangerously rapid pressure change.</p>
	<p>(No operation particularly)</p>	
	<p>PMV full open operation Fully opens PMV (Pulse motor valve). When SW801 is pressed again or after 2 minutes, the operation returns to the normal control.</p>	
	<p>PMV full close operation Fully closes PMV (Pulse motor valve). When SW801 is pressed again or after 2 minutes, the operation returns to the normal control.</p>	
	<p>PMV half open operation Half opens (250 pulses) PMV (Pulse motor valve). When SW801 is pressed again or after 2 minutes, the operation returns to the normal control.</p>	
	<p>4-way valve relay operation (RY700, CN700 for check) Sets 4-way valve energization relay (RY700) to ON. When SW801 is pressed again or after 2 minutes, the operation returns to the normal control.</p> <p>Caution: Do not connect the coil into the body when perform this operation.</p>	

SW804	Operation when press button switch SW801 is pressed	
SW804 	Self-holding valve vacuum operation (Switch to heating cycle) (RY700, RY701, RY705, CN701 for check) Sets relay RY700, RY701, and RY705 to ON. (CN701 Between 1 to 4 Voltage = Approx. 325V) This function operates for 10 seconds. After that it becomes OFF.	Caution: Although these controls are available during an operation, basically perform them when no operation is in progress. Performing these controls during an operation may cause dangerously rapid pressure change.
SW804 	Self-holding valve release operation (Switch to cooling cycle) Sets relay RY700 to ON. (CN701 Between 1 to 4 Voltage = Approx. 325V) This function operates for 10 seconds. After that it becomes OFF.	
SW804 	SV valve relay operation (RY702, CN702 for check) Sets SV valve relay (RY702) to ON. When SW801 is pressed again or after 2 minutes, the operation returns to the normal control. * HWS-1102 and 1402H-E do not have the parts mounted, so this operation is unavailable.	
SW804 	Heater output relay operation (RY703, CN703 for check) Sets relay for optional heater (RY703) to ON. When SW801 is pressed again or after 2 minutes, the operation returns to the normal control.	
SW804 	External output relay operation (RY704, CN704 for check) Sets relay for external output (RY704) to ON. When SW801 is pressed again or after 2 minutes, the operation returns to the normal control.	
SW804 	(No operation particularly)	
SW804 	External output relay operation change Note: Do not use this setting.	

(Note 1) The forced trial operation with this setting cannot be cancelled by the remote controller in the hydro unit. Be sure to cancel the operation from the outdoor unit. (Press again SW801 for 1 second)

11 How to Exchange Main Parts

⚠ WARNING

<Turn off the power breaker>

Because the electrical components are energized with high voltage, always turn off the power breaker before starting to work.

<Check>

After a repair is complete, perform a trial operation (after attaching the front panel, upper and lower cabinets, and side cabinet) and check that no abnormality including smoke or abnormal noise occurs. Failure to do so may cause a fire or an electric shock. Place the cabinets before making a trial operation.

<Watch out for fire>

Observe the following instructions when repairing the refrigerant cycle.

- (1) Watch out for surrounding fire. Always put out the fire of stove burner or other devices before starting the repair.
Should the fire fail to be put out, the oil mixed with refrigerant gas could catch fire.
- (2) Do not use a welder in a closed room.
A room with no ventilation may cause carbon monoxide poisoning.
- (3) Keep away flammable materials.
The materials may catch the fire of a welder.

⚠ CAUTION

<Wear gloves>

Wear gloves (*) when performing repair.

Failure to do so may cause an injury when accidentally contacting the parts.

*: Thick gloves such as cotton work gloves

1. Hydro Unit

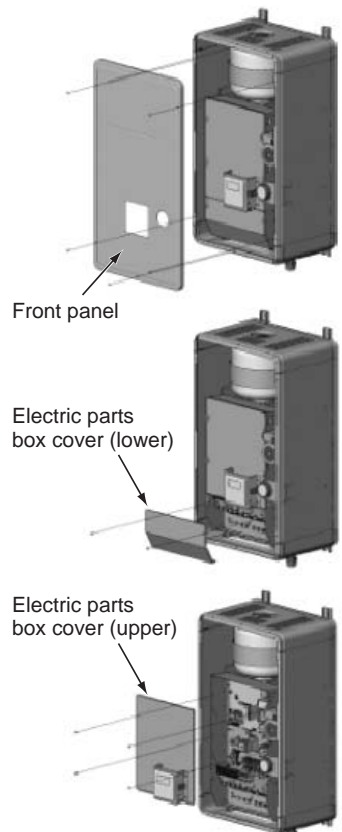
No.	Exchange parts name	Work procedure	Remarks
1	Common procedure Front panel Electric parts box cover (lower) Electric parts box cover (upper)	<div style="border: 1px solid black; padding: 5px; margin-bottom: 10px;">Wear gloves when performing the work. Failure to do so may cause an injury when accidentally contacting the parts.</div> <p>1. How to remove</p> <ol style="list-style-type: none"> 1) Stop the hydro unit operation, and turn off the power breaker. 2) Remove the front panel. (ST1T Ø4 × 10 6 screws) 3) After unscrew the screws, remove the front panel by pulling it toward you. 4) Remove the electric parts box cover (lower). (ST2T Ø4 × 8 2 screws) 5) Disconnect the power source cable and outdoor unit connecting cable from the terminal block. 6) Remove the electric parts box cover (upper). (ST2T Ø4 × 8 4 screws) 7) Disconnect the remote controller connecting cable from the CN41 connector of the water heat exchange board. <p>2. How to attach</p> <ol style="list-style-type: none"> 1) Connect the remote controller connecting cable to the water heat exchange board. 2) Attach the electric parts box cover (upper). 3) Connect the power source cable and outdoor unit connecting cable to the terminal block, and fix with the cord clamp. 4) Attach the electric parts box cover (lower). 5) Attach the front panel. 	 <p>The diagrams illustrate the three steps of the procedure: 1) Removing the front panel, 2) Removing the lower electric parts box cover, and 3) Removing the upper electric parts box cover. Each diagram shows the part being removed from the hydro unit with arrows indicating the direction of removal.</p>

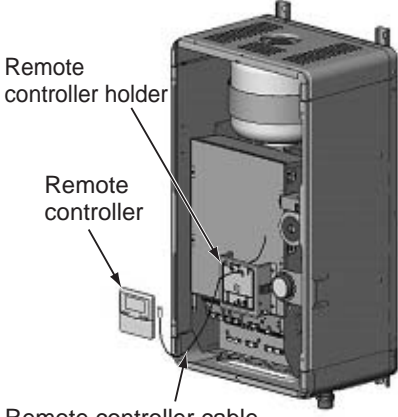
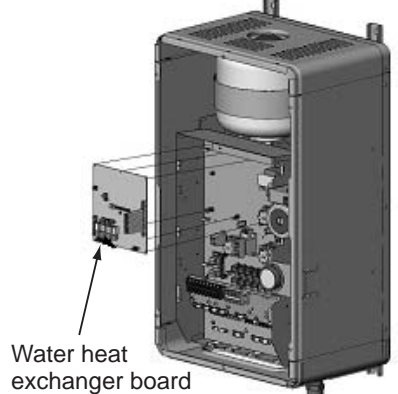
No.	Exchange parts name	Work procedure	Remarks
2	Remote controller	<p>1.How to remove</p> <ol style="list-style-type: none"> 1)Perform the step 1-1. 2)Remove the remote controller from the holder using a flat-blade screwdriver. (Release the stopper.) 3)Disconnect the remote controller cable from the terminal block on the back side of the remote controller. <p>2.How to attach</p> <ol style="list-style-type: none"> 1)Attach it in the reverse order of the removal. 	 <p>Remote controller holder</p> <p>Remote controller</p> <p>Remote controller cable</p>
3	Water heat exchanger board MCC-1511	<p>1. How to remove</p> <ol style="list-style-type: none"> 1)Perform the step 1-1. 2)Disconnect the connectors and lead cables connected to other parts from the water heat exchanger board. <p>1. Connector</p> <ul style="list-style-type: none"> CN100: TB 01 3P Connector (5P: White) CN101: Trans (3P: White) CN102: Trans (6P: White) CN200: Float switch (3P: Red) CN201: Pressure switch (2P: White) CN202: Bimetal thermostat (3P: Yellow) CN203: TC sensor (2P: Yellow) CN204: TWI sensor (3P: Brown) CN205: TWO sensor (2P: Red) CN206: THO sensor (3P: White) CN207: Lo pressure sensor (2P: Blue) CN212: Lo pressure sensor (4P: White) CN213: TB 06 4P Terminal block (3P: White) CN214: TB 06 4P Terminal block (2P: White) CN305: TB 01 3P Terminal block (3P: Green) CN501: Relay board (6P: Yellow) CN601: Relay 05 (3P: Red) CN602: TB 04 6P Terminal block (7P: White) CN603: Pump (3P: Yellow) CN604: Relay 06, TB 04 4P Terminal block (7P: Blue) CN605: Relay 01, Relay 02 (3P: Yellow) CN606: Relay 03, Relay 04 (3P: Blue) <p>2. Round-shape terminal</p> <ul style="list-style-type: none"> 100: Ground (ST2T Ø4 × 8 1 wire) <p>Note</p> <p>When removing the connector, release the safety lock of the housing.</p> <p>3)Release the 6 stoppers of the water heat exchanger board to remove the board.</p>	 <p>Water heat exchanger board</p>

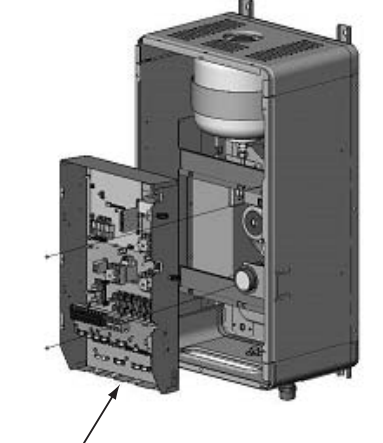
No.	Exchange parts name	Work procedure	Remarks
4	Relay board MCC-1431	<p>1. How to remove</p> <ol style="list-style-type: none"> 1) Perform the step 1-1. 2) Disconnect the connectors and lead cables connected to other parts from the relay board. <p>1. Connector CN01: TB 01 3P Terminal block (3P: White) CN02: Water heat exchanger board (5P: White) CN10: TB 05 9P Terminal block (9P: White)</p> <p>Note When removing the connector, release the safety lock of the housing.</p> <ol style="list-style-type: none"> 3) Release the 3 stoppers of the relay board to remove the board. 	 <p>Relay board</p>
5	Electric parts assembly	<p>1. How to remove</p> <ol style="list-style-type: none"> 1) Perform the step 1-1. 2) Disconnect the connectors and lead cables connected to other parts from the water heat exchanger board. <p>1. Connector CN200: Float switch (3P: Red) CN201: Pressure switch (2P: White) CN202: Bimetal thermostat (3P: Yellow) CN203: TC sensor (2P: Yellow) CN204: TWI sensor (3P: Brown) CN205: TWO sensor (2P: Red) CN206 THO sensor (3P: White) CN207: Lo pressure sensor (2P: Blue) CN212: Lo pressure sensor (4P: White) CN603: Pump (3P: Yellow) Disconnect the heater power source cable (For backup heater and hot water cylinder heater) from the MgSW.</p> <p>Note When removing the connector, release the safety lock of the housing.</p> <ol style="list-style-type: none"> 3) Remove the fixed screws. (ST2T Ø4 × 8, 2 screws) 4) Remove the electric parts assembly by pulling it toward you while pulling it upward because the assembly back side has a hook holding structure. 	 <p>Electric parts assembly</p>

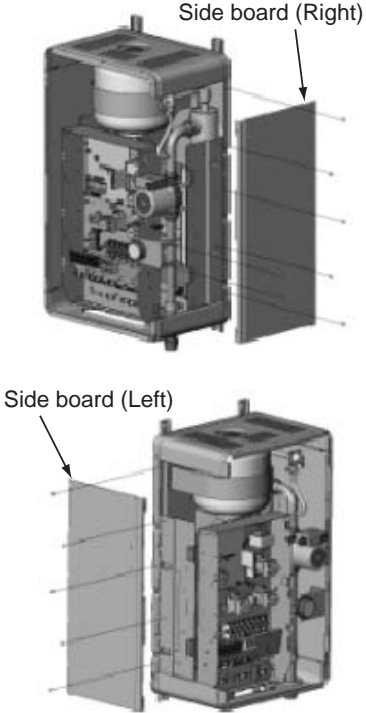
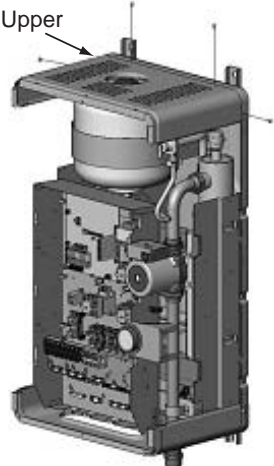
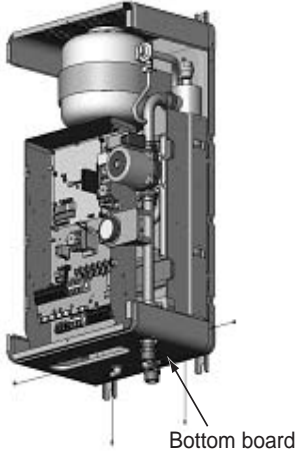
No.	Exchange parts name	Work procedure	Remarks
6	Side board	<p>1. Side board (Right)</p> <p>1) Perform the step 1-1.</p> <p>2) Remove the fixed screws of the side board (Right). (ST1T Ø4 × 10, 5 screws)</p> <p>3) Remove the fixed screws of the side board (Right) and the manometer fixing board. (ST1T Ø4 × 10, 2 screws)</p> <p>2. Side board (Left)</p> <p>1) Remove the fixed screws of the side board (Left). (ST1T Ø4 × 10, 5 screws)</p>	
7	Upper board	<p>1) Perform the step 1-1 and step 6.</p> <p>2) Remove the fixed screws of the upper board. (ST1T Ø4 × 10, 4 screws)</p>	
8	Bottom board	<p>1) Perform the step 1-1 and step 6.</p> <p>2) Remove the fixed screws of the bottom board. (ST1T Ø4 × 10, 4 screws)</p>	

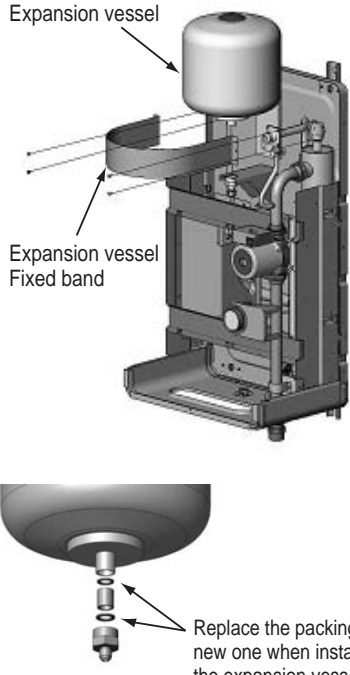
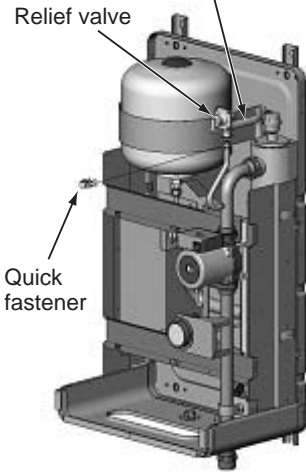
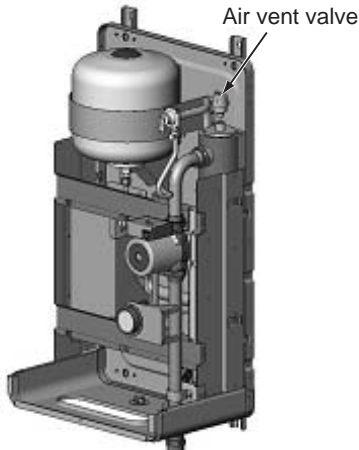
No.	Exchange parts name	Work procedure	Remarks				
9	Expansion vessel	<p>To replace a water circuit part, first close the water supply source valve and the valve of water pipe connected to the hydro unit.</p> <ol style="list-style-type: none"> 1) Perform the step 1-1, step 5, 6, and 7. 2) Remove the fixed band of the expansion vessel. (ST1T Ø4 × 8, 4 screws) 3) Remove the expansion vessel connection (three-piece flare nut). <p>Replace the packing to new one when installing the expansion vessel.</p> <table border="1" data-bbox="491 658 986 725"> <tr> <td>Part code</td> <td>Service parts</td> </tr> <tr> <td>37595721</td> <td>Service packing assembly</td> </tr> </table> <p>After the expansion vessel replacement repair, open the water supply source valve and water piping valve to pass water through the hydro unit, and check that the expansion vessel connection has no water leakage.</p>	Part code	Service parts	37595721	Service packing assembly	
Part code	Service parts						
37595721	Service packing assembly						
10	Relief valve	<p>To replace a water circuit part, first close the water supply source valve and the valve of water pipe connected to the hydro unit.</p> <ol style="list-style-type: none"> 1) Perform the step 1-1, step 5, 6, and 7. 2) Remove the quick fastener. 3) Remove the relief valve by pulling it upward. <p>The relief valve connection uses an O ring for water seal. Be careful not to scratch the O ring; otherwise, water leakage may occur.</p> <p>After the relief valve replacement repair, open the water supply source valve and water piping valve to pass water through the hydro unit, and check that the relief valve connection has no water leakage.</p>	<p>Relief valve connecting hose Internal diameter: 15mm, Length: 850L</p> 				
11	Air vent valve	<p>To replace a water circuit part, first close the water supply source valve and the valve of water pipe connected to the hydro unit.</p> <ol style="list-style-type: none"> 1) Perform the step 1-1, step 5, 6, and 7. 2) Remove the air vent valve. <p>After the air vent valve replacement repair, open the water supply source valve and water piping valve to pass water through the hydro unit, and check that the air vent valve connection has no water leakage.</p>					

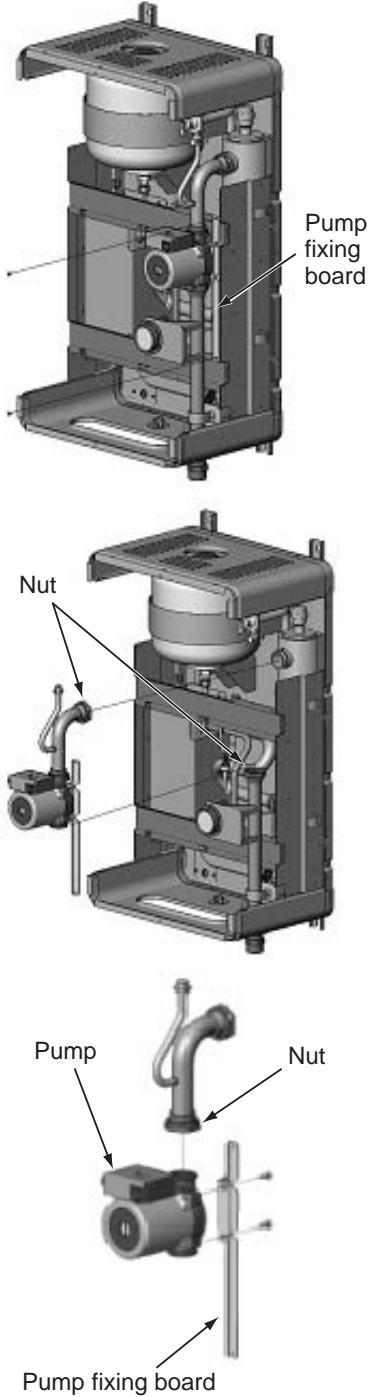
No.	Exchange parts name	Work procedure	Remarks						
12	Pump	<p data-bbox="456 293 983 383">To replace a water circuit part, first close the water supply source valve and the valve of water pipe connected to the hydro unit.</p> <p data-bbox="440 409 616 432">1. How to remove</p> <ol data-bbox="456 439 999 663" style="list-style-type: none"> 1) Perform the step 1-1, step 5, 6, and 10. 2) Remove the fixed screws of the pump fixing board. (ST1T Ø4 × 8, 2 screws) 3) Remove the 2 nuts of the heater connection and the lower side of the pump. 4) Remove the pump fixing board. (ST3T Ø6 × 16, 2 screws) 5) Remove the nut of the upper part of the pump. <p data-bbox="440 692 600 714">2. How to attach</p> <p data-bbox="456 736 983 826">The pump connection uses a liquid packing for water seal. When replacing the pump, use a packing which was slathered with the liquid gasket.</p> <table border="1" data-bbox="456 837 983 949"> <thead> <tr> <th>Part code</th> <th>Service parts</th> </tr> </thead> <tbody> <tr> <td>37595721</td> <td>Packing</td> </tr> <tr> <td>37595722</td> <td>Liquid gasket</td> </tr> </tbody> </table> <p data-bbox="456 972 951 1028">1) Attach a new pump in the reverse order of the removal.</p> <p data-bbox="456 1055 983 1167">After the pump replacement repair, open the water supply source valve and water piping valve to pass water through the hydro unit, and check that the pump connection has no water leakage.</p>	Part code	Service parts	37595721	Packing	37595722	Liquid gasket	 <p data-bbox="1358 512 1430 591">Pump fixing board</p> <p data-bbox="1070 875 1126 898">Nut</p> <p data-bbox="1086 1341 1158 1364">Pump</p> <p data-bbox="1342 1346 1398 1368">Nut</p> <p data-bbox="1070 1666 1270 1688">Pump fixing board</p>
Part code	Service parts								
37595721	Packing								
37595722	Liquid gasket								

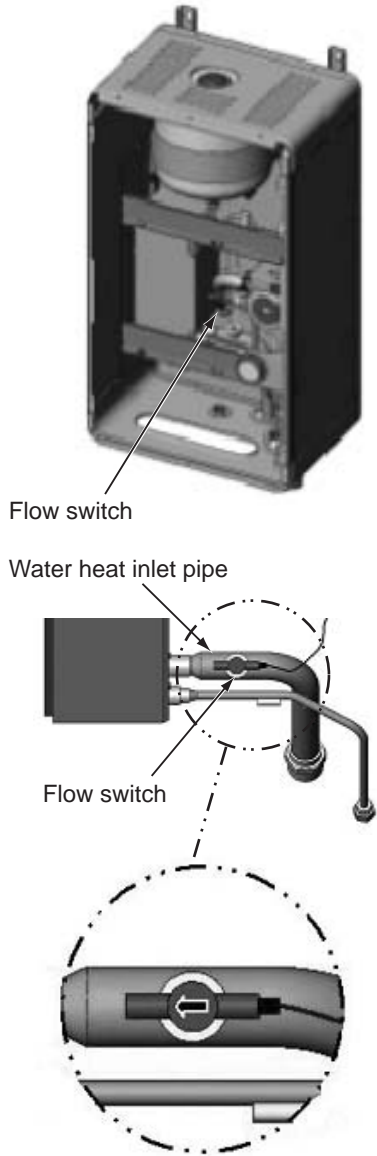
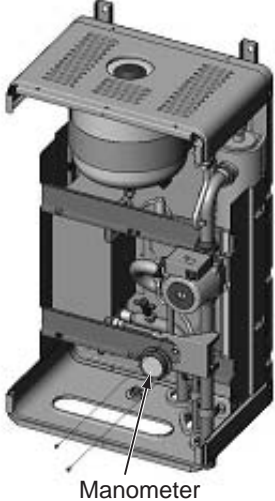

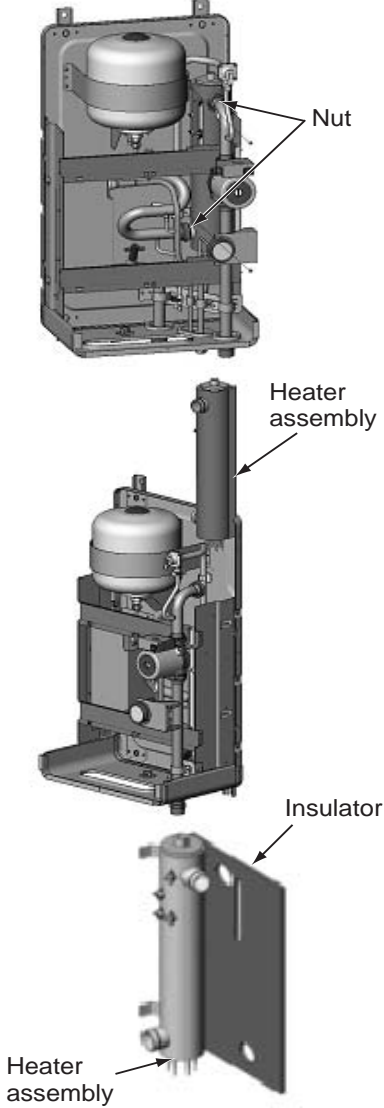
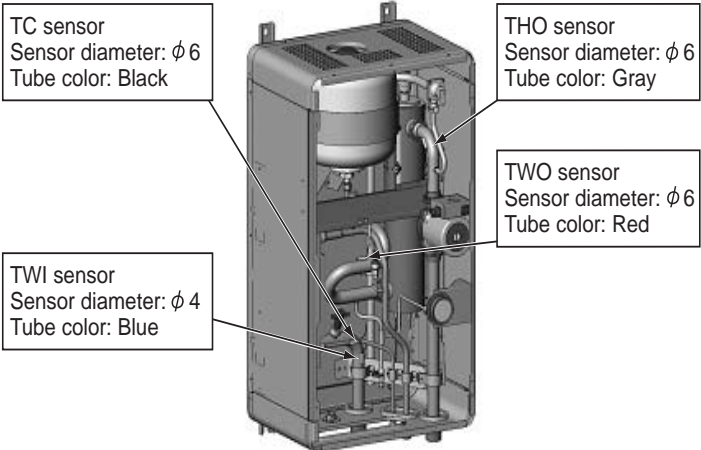
No.	Exchange parts name	Work procedure	Remarks
13	Flow switch	<p>To replace a water circuit part, first close the water supply source valve and the valve of water pipe connected to the hydro unit.</p> <p>1. How to remove 1) Perform the step 1-1 and step 5. 2) Remove the flow switch.</p> <p>The flow switch connection uses an O ring for water seal. Be careful not to scratch the O ring; otherwise, water leakage may occur.</p> <p>2. How to attach 1) Attach a new flow switch in the reverse order of the removal.</p> <p>Note1) As shown on the right, place a flow sensor parallel to the water heat exchanger inlet pipe so that the wire is place on the right side from the front view.</p> <p>After the flow switch replacement repair, open the water supply source valve and water piping valve to pass water through the hydro unit, and check that the flow switch connection has no water leakage.</p>	 <p>The diagram illustrates the internal components of a hydro unit. An arrow points to the flow switch located near the water heat inlet pipe. Below, a detailed view shows the flow switch being installed on the pipe, with the sensor wire positioned on the right side of the front view.</p>
14	Manometer	<p>To replace a water circuit part, first close the water supply source valve and the valve of water pipe connected to the hydro unit.</p> <p>1. How to remove 1) Perform the step 1-1 and step 5 and 6. 2) Remove the manometer.</p> <p>After the manometer replacement repair, open the water supply source valve and water piping valve to pass water through the hydro unit, and check that the manometer connection has no water leakage.</p>	 <p>The diagram shows the internal components of a hydro unit with an arrow pointing to the manometer located at the bottom of the unit.</p>

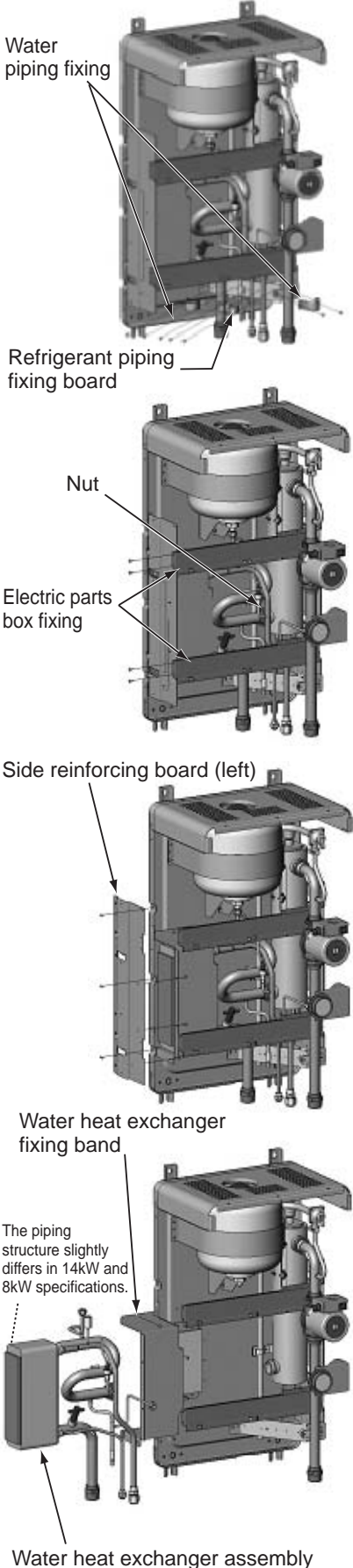
No.	Exchange parts name	Work procedure	Remarks						
15	Heater assembly	<p>To replace a water circuit part, first close the water supply source valve and the valve of water pipe connected to the hydro unit.</p> <p>1. How to remove 1) Perform the step 1-1, step 5, 6, 7, and 11. 2) Remove the nut of the heater connection. 3) Remove the 2 fixed screws of the heater. 4) Pull the heater out upward. 5) Remove the insulator from the heater.</p> <p>2. How to attach</p> <p>The heater connection uses a liquid packing for water seal. When replacing the heater, use a packing which was slathered with the liquid gasket.</p> <table border="1" data-bbox="453 752 986 866"> <thead> <tr> <th>Part code</th> <th>Service parts</th> </tr> </thead> <tbody> <tr> <td>37595721</td> <td>Packing</td> </tr> <tr> <td>37595722</td> <td>Liquid gasket</td> </tr> </tbody> </table> <p>1) Attach a new heater in the reverse order of the removal.</p> <p>After the heater assembly replacement repair, open the water supply source valve and water piping valve to pass water through the hydro unit, and check that the heater connection has no water leakage.</p>	Part code	Service parts	37595721	Packing	37595722	Liquid gasket	
Part code	Service parts								
37595721	Packing								
37595722	Liquid gasket								
16	TC sensor TWI sensor TWO sensor THO sensor	<p>1. How to remove</p> <p>1) Perform the step 1-1 and step 5. 2) Take the sensor out.</p>	 <p>TC sensor Sensor diameter: $\phi 6$ Tube color: Black</p> <p>TWI sensor Sensor diameter: $\phi 4$ Tube color: Blue</p> <p>TWO sensor Sensor diameter: $\phi 6$ Tube color: Red</p> <p>THO sensor Sensor diameter: $\phi 6$ Tube color: Gray</p>						

No.	Exchange parts name	Work procedure	Remarks
17	Water heat exchanger assembly	<ul style="list-style-type: none"> • Close the water piping source valve and the valve of water pipe connected to the hydro unit, and then remove the refrigerant and water piping. • Perform refrigerant recovery with the outdoor unit. • Disconnect all the power source cable, outdoor unit connection cable, and cylinder connection cable. <p>1. How to remove</p> <ol style="list-style-type: none"> 1) Perform the step 1-1, step 5, 6, and 8. 2) Remove the water pipe fixing board. (ST2T Ø4 × 8, 2 screws) 3) Remove the refrigerant piping fixing board. (ST2T Ø4 × 8, 3 screws) 4) Remove the nut of the heater connection. 5) Remove the fixed screws of the electric parts box fixing board. (ST2T Ø4 × 8, 4 screws) 6) Remove the side reinforcing board (left). (ST2T Ø4 × 8, 6 screws) 3 for inside, 3 for outside 7) Remove the water heat exchanger fixing band. (ST2T Ø4 × 8, 6 screws) 8) Remove the water heat exchanger assembly. <div style="border: 1px solid black; padding: 5px; margin: 10px 0;"> <p>The heater connection uses a packing for water seal. Be careful not to scratch the packing; otherwise, water leakage may occur.</p> </div> <p>2. How to attach</p> <ol style="list-style-type: none"> 1) Attach a new water heat exchanger assembly in the reverse order of the removal. 2) Restore all piping and wiring as in the original state, and check that there is no water or refrigerant leakage. <ul style="list-style-type: none"> • After the water heat exchanger assembly replacement repair, open the water supply source valve and water piping source valve to pass water through the hydro unit, and check that the connection has no water leakage. • After connecting the refrigerant pipe, check that the connection has no refrigerant leakage. 	

2. Outdoor Unit

2-1. HWS-802H-E

No.	Exchange parts name	Work procedure	Remarks
1	Common procedure	<p>Note Wear gloves when performing the work. Failure to do so may cause an injury when accidentally contacting the parts.</p> <p>1. How to remove</p> <ol style="list-style-type: none"> 1) Stop the operation by remote controller and turn off the breaker. 2) Remove the front panel. (Hex Ø4 × 10, 2 screws) <ul style="list-style-type: none"> • After unscrewing the screws, remove the front panel while pulling it downward. 3) Disconnect the power source cable and connecting cables between hydro and outdoor from the cord plank and terminals. 4) Remove the top board. (Hex Ø4 × 10, 5 screws) <p>2. How to attach</p> <ol style="list-style-type: none"> 1) Attach the top board. (Hex Ø4 × 10, 5 screws) At this time, insert the back side fin guard between the top board and the water heat exchanger (back side). 2) Connect the power source cable and connecting cables between indoor and outdoor to the terminal, and fix them with the cord clamp. <p>Note The power source cable and connecting cable between hydro and outdoor units must be fixed along the connecting piping by using a cable tie so that the cables do not contact the compressor, gas side valve, gas side piping and outlet pipe.</p> <ol style="list-style-type: none"> 3) Attach the front panel. (Hex Ø4 × 10, 2 screws) 	<p style="text-align: center;">Front panel</p>  <p style="text-align: center;">Top board</p>  <p style="text-align: center;">Insert the back side fin guard between the top board and the heat exchanger (back side).</p> 

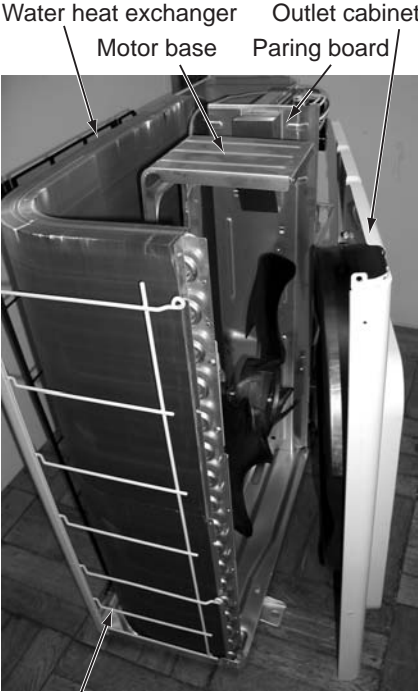
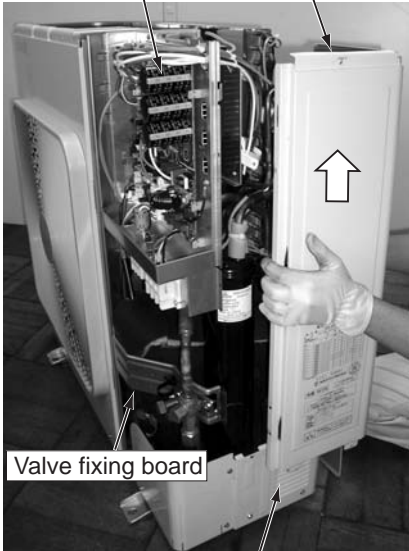
No.	Exchange parts name	Work procedure	Remarks
2	Outlet cabinet	<p>How to remove</p> <ol style="list-style-type: none"> 1) Perform the step 1-1. 2) Remove the screws of the outlet cabinet and parting board. (ST1T Ø4 × 8, 3 screws) 3) Remove the screws of the outlet cabinet and bottom board. (Hex Ø4 × 10, 2 screws) 4) Remove the screws of the outlet cabinet and motor base. (ST1T Ø4 × 8, 2 screws) 5) Remove the screws of the outlet cabinet and water heat exchanger. (ST1T Ø4 × 8, 1 screw) 6) Remove the screws of the outlet cabinet and fin guard. (Hex Ø4 × 10, 2 screws) 	 <p>Water heat exchanger Outlet cabinet Motor base Parting board</p> <p>Fin guard</p>
3	Side cabinet	<ol style="list-style-type: none"> 1) Perform the step 1-1. 2) Remove the screws that fixes the inverter assembly and the side cabinet. (ST1T Ø4 × 8, 2 screws) 3) Remove the screws of the side cabinet and valve fixing board. (ST1T Ø4 × 8, 2 screws) 4) Remove the screws of the side cabinet and piping panel (back). (Hex Ø4 × 10, 2 screws) 5) Remove the screws of the side cabinet and bottom board. (Hex Ø4 × 10, 1 screw) 6) Remove the screws of the side cabinet and water heat exchanger. (Hex Ø4 × 10, 3 screws) 7) Remove the side cabinet while shifting it upward. (Inverter hook) 	 <p>Inverter assembly Side cabinet</p> <p>Valve fixing board</p> <p>Piping panel (back)</p>

No.	Exchange parts name	Work procedure	Remarks
4	Electric parts replacement	<p>1. Control board 1) Perform the step 1-1.</p> <p>WARNING For 1 minute after the power is turned off, do not disassemble the inverter to prevent an electric shock.</p> <p>2) Remove the connector connected to the control board. (Hydro power source, temperature sensor, electric control valve coil, 4-way valve coil, compressor case thermostat, fan motor) * Remove the connector by releasing the lock in the housing.</p> <p>3) Remove the lead cable connected to the control board. (Torque at tightening is 1.47 ±0.1N•m) Compressor lead U: CN200 Red V: CN201 White W: CN202 Black</p> <p>Remove the power source cable from the power source terminal block. (Torque at tightening is 2.5 ±0.1N•m)</p> <p>4) Remove the ground wire of the control board. (Truss B tight screw Ø4 × 6, 1 screw)</p> <p>5) Remove the fixed screws of the control board. (Collar screw for fixing element Ø3 × 16, 7 screws, Pan S-tight screw for fixing the board Ø3 × 20, 1 screw)</p> <p>6) Remove the control board. (Supporter 5 positions) Note) Removing the control board may be difficult due to the heat release grease for the heat sink.</p> <p>7) Attach a new control board. Note) • Be careful for not taking the compressor lead V: CN201 White for the reactor lead CN05 or 06 White. (The compressor lead has a transparent sleeve at its ring terminal. The reactor lead ring terminal does not have sleeve.) • Be sure to attach the aluminium board (Q201) and the insulating sheet (Q300). (Applying beforehand a bit of heat release grease to the back side of the insulating sheet can easily paste the sheet to the heat sink.)</p>	

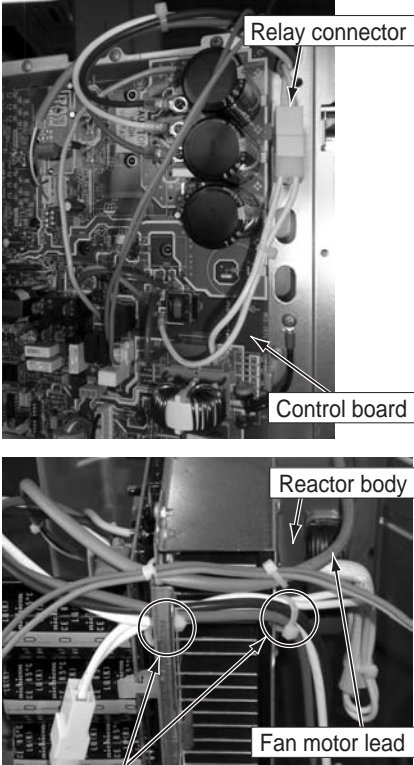
No.	Exchange parts name	Work procedure	Remarks
4	Electric parts replacement	<p>2. Reactor</p> <ol style="list-style-type: none"> 1) Perform the step 1-1. 2) Remove the relay connector connected to the control board. 3) Cut the binding tie that binds the compressor leads and relay connectors. 4) Remove the reactor. (Truss B tight screw $\varnothing 4 \times 6$, 2 screws) 5) Attach a new reactor. <p>Note)</p> <p>Be sure to bind the removed binding tie by using the commercially available binding tie. Make sure that the fan motor lead and the reactor body do not contact each other.</p>	 <p>Relay connector</p> <p>Control board</p> <p>Reactor body</p> <p>Fan motor lead</p> <p>Binding tie (Compressor lead, Relay connector)</p>

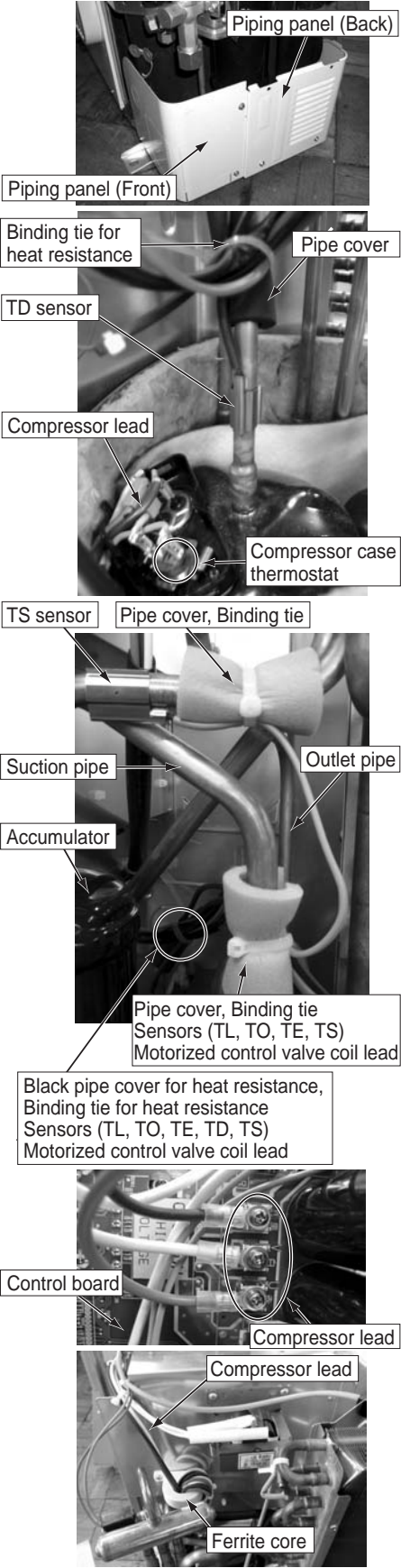

No.	Exchange parts name	Work procedure	Remarks
5	Fan motor	<p>1) Perform the step 1-1 and step 2.</p> <p>2) Remove the fan motor and the flange nut that fixes the propeller fan.</p> <ul style="list-style-type: none"> • To loosen the flange nut, turn it clockwise. (Turn it counterclockwise for tightening.) <p>3) Remove the propeller fan.</p> <p>4) Remove the connector for fan motor from the inverter. (control board)</p> <p>5) Remove the fan motor lead from the fan motor lead fixing rubber on the through hole of the parting board.</p> <p>6) Remove the fixed screws (4 for each) while holding the fan motor so that it does not drop.</p> <p>* Notes in assembling fan motor</p> <ul style="list-style-type: none"> • Tighten the flange nut in 4.95 N·m (50kgf·cm) • To prevent the fan motor lead from contacting the propeller fan, adjust the length of fan motor lead fixing rubber so that it does not slack. Attach the fan motor lead fixing rubber to the parting board so that the projection part is placed on the refrigerant cycle side. • Make sure that the reactor body and the fan motor lead do not contact each other. • Be sure to bind the removed binding tie by using the commercially available binding tie. <p>Note Fix the fan motor lead to the motor base using a metal tie so that the fan motor lead does not contact the propeller fan.</p>	

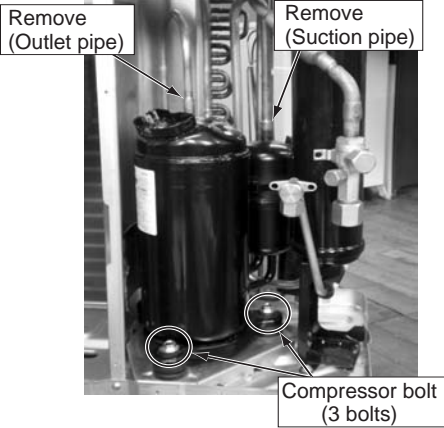
No.	Exchange parts name	Work procedure	Remarks
6	Compressor Compressor lead	<p>1. Remove defective compressor 1) Perform refrigerant gas recovery.</p> <p>2) Perform the step 1-1 and step 2 and 3.</p> <p>3) Remove the piping panel (Front). Remove screws of the piping panel (Front) and bottom board. (Hex Ø4 × 10, 2 screws) Remove screws of the piping panel (Front and Back). (Hex Ø4 × 10, 1 screw)</p> <p>4) Remove the piping panel (Back). Remove screws of the piping panel (Back) and bottom board. (Hex Ø4 × 10, 2 screws)</p> <p>5) Remove the valve fixing board. Remove the bolt of the valve. (Hex head bolt Ø6 × 15, 4 bolts) Remove the screws of the valve fixing board and parting board. (ST1T Ø4 × 8, 1 screw) Remove the screws of the valve fixing board and accumulator. (ST1T Ø4 × 8, 1 screw) Cut the binding tie of the discharge pipe and suction pipe to remove each sensor and the pulse motor valve coil lead.</p> <p>6) Remove the soundproofing board. (Upper, Inward winding, Outward winding)</p> <p>7) Remove the compressor terminal cover, and then remove the compressor lead and compressor case thermostat.</p> <p>8) Remove the TD sensor fixed to the discharge pipe.</p> <p>9) Remove the compressor lead. (Leave the ferrite core attached to the electric parts box.) Control board U: CN200 Red V: CN201 White W: CN202 Black (Torque at tightening is 1.47 ±0.1N·m)</p>	 <p>Piping panel (Back)</p> <p>Piping panel (Front)</p> <p>Binding tie for heat resistance</p> <p>Pipe cover</p> <p>TD sensor</p> <p>Compressor lead</p> <p>Compressor case thermostat</p> <p>TS sensor</p> <p>Pipe cover, Binding tie</p> <p>Suction pipe</p> <p>Outlet pipe</p> <p>Accumulator</p> <p>Pipe cover, Binding tie Sensors (TL, TO, TE, TS) Motorized control valve coil lead</p> <p>Black pipe cover for heat resistance, Binding tie for heat resistance Sensors (TL, TO, TE, TD, TS) Motorized control valve coil lead</p> <p>Control board</p> <p>Compressor lead</p> <p>Compressor lead</p> <p>Ferrite core</p>

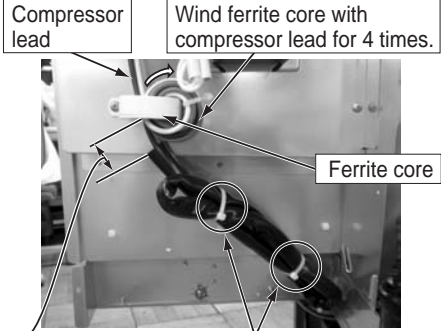
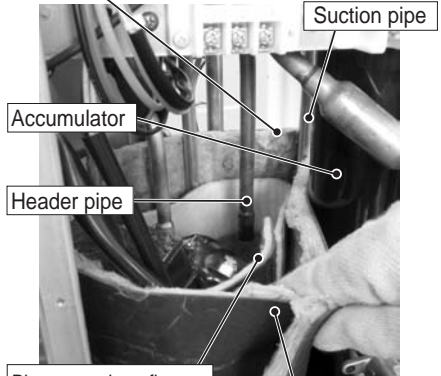
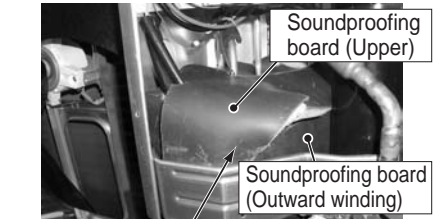
No.	Exchange parts name	Work procedure	Remarks
6	Compressor Compressor lead	<p>10) Remove the discharge and suction pipes connected to the compressor by using a burner.</p> <p>WARNING When removing the piping by burning the solder, take enough care for a fire going off at the moment the wax melts if oil remains inside the piping.</p> <p>Note) Do not make fire flame contact with the 4-way valve and pulse motor valve. (This may cause an operation failure.)</p> <p>11) Pull out the discharge and suction pipes of the refrigerant cycle upward.</p> <p>12) Remove the compressor bolts that fix the compressor to the bottom board. (3 bolts)</p> <p>13) Pull the compressor out toward you.</p> <p>Note) The compressor weighs 15 kg or more. Two people should be required to handle it.</p>	

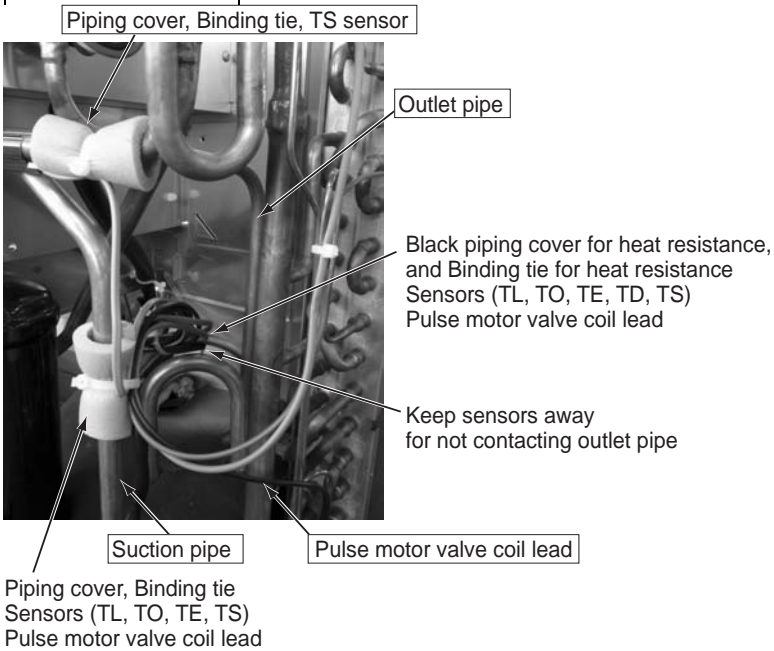

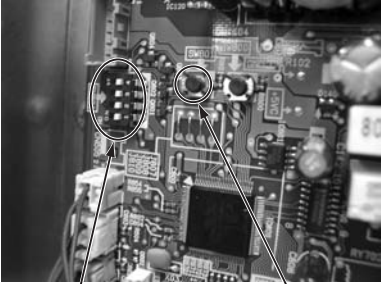
No.	Exchange parts name	Work procedure	Remarks
6	Compressor Compressor lead	<p>2. Attach the compressor</p> <p>1) Attach the compressor in the reverse order of the removal.</p> <p>Note)</p> <ul style="list-style-type: none"> • Be sure to replace the compressor lead after the compressor replacement. (Compressor lead spare parts code: 43160591) At this time, wind the ferrite core with the compressor lead for 4 times. Bind the compressor lead that is long with a commercially available binding tie. When doing this, be careful for the compressor lead not to contact the discharge pipe. • Fix the removed sensors and pulse motor valve coil lead to the outlet and suction pipes through the piping cover by using a binding tie. At this time, be careful for the sensors and pulse motor valve coil lead not to contact the discharge pipe. (To fix the sensors and leads, use the black piping cover for heat resistance and a commercially available binding tie for heat resistance.) • Attach the soundproofing board (Inward winding, Outward winding), as shown in the right figure, through between the compressor and between the piping and parting board. • Place the compressor lead and the compressor case thermostat so that they fall into between the inward winding and outward winding of the soundproofing board. 	 <p>Compressor lead</p> <p>Wind ferrite core with compressor lead for 4 times.</p> <p>Ferrite core</p> <p>0 to 50 (Compressor lead positioning standard)</p> <p>Bind the lead at 2 positions with a commercially available binding tie</p> <p>Place soundproofing board (Outward winding) through between suction pipe and accumulator</p>  <p>Suction pipe</p> <p>Accumulator</p> <p>Header pipe</p> <p>Place soundproofing board (Inward winding) through between suction pipe and header pipe</p> <p>Overlap soundproofing board (Outward winding) at this position</p>  <p>Soundproofing board (Upper)</p> <p>Soundproofing board (Outward winding)</p> <p>Do not make gap between soundproofing boards (Upper and Outward winding)</p>



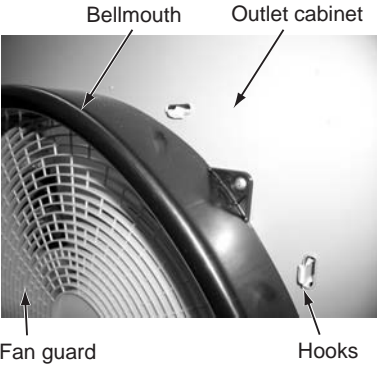

No.	Exchange parts name	Work procedure	Remarks
6	Compressor Compressor lead	<p>3. Vacuuming</p> <ol style="list-style-type: none"> 1) Connect the vacuum pump to the charge port of the gas piping valve to operate the vacuum pump. 2) Perform vacuuming until the vacuum low pressure gauge shows 1(mmHg). <p>Note)</p> <p>Open fully the pulse motor valve before vacuuming. With the valve closed, vacuuming between the outdoor unit liquid valve and the pulse motor valve may fail.</p> <p>How to make pulse motor valve forcible full open</p> <ul style="list-style-type: none"> • Turn on the electric leakage breaker. • Set the SW804 dip switch 1 and 3 on the outdoor unit control board to ON. • Press SW801 on the outdoor unit control board for 1 second or longer. • After pressing SW801 for 1 second or longer, turn off the electric leakage breaker within 2 minutes. <p>4. Charge refrigerant</p> <ol style="list-style-type: none"> 1) Add refrigerant whose amount is defined according to the piping length from the valve charge port. (HWS-802H : 1.8kg) 	 <p>SW804 SW801</p>
7	Pulse motor valve coil	<ol style="list-style-type: none"> 1. How to remove <ol style="list-style-type: none"> 1) Perform the step 1-1 and step 3. 2) Remove the coil from the pulse motor valve body while pulling the coil upward to release the spring holding the copper pipe. 2. How to attach <ol style="list-style-type: none"> 1) Fix the spring to the copper pipe. 	 <p>Pulse motor valve coil</p> <p>Spring Pulse motor valve body</p>

No.	Exchange parts name	Work procedure	Remarks
8	Fan guard	<p>1. How to remove</p> <p>1) Perform the step 1-1 and step 2.</p> <p>Note Perform a replacement work on cardboard or cloth to prevent the product from being damaged.</p> <p>2) Remove the outlet cabinet and put with the fan guard side down.</p> <p>3) Release the hooks (8 positions) of the fan guard.</p> <p>2. How to attach</p> <p>1) Press the hooks (8 positions) with hands from the front side to fix them.</p> <p>Note Check that all the hooks are fixed to the given positions.</p>	

2-2. HWS-1102H-E, 1402H-E

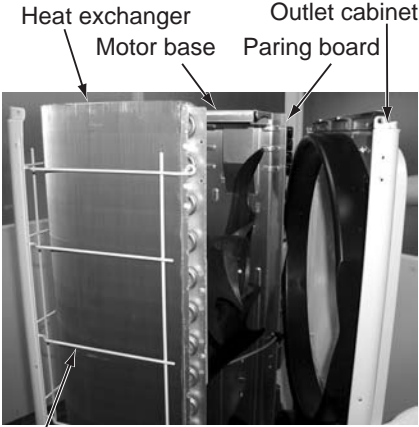
No.	Exchange parts name	Work procedure	Remarks
1	Common procedure	<p>Note Wear gloves when performing the work. Failure to do so may cause an injury when accidentally contacting the parts.</p> <p>1. How to remove 1) Stop the operation by remote controller and turn off the breaker. 2) Remove the front panel. (Hex Ø4 × 10, 2 screws) • After unscrewing the screws, remove the front panel while pulling it downward. 3) Disconnect the power source cable and connecting cables between hydro and outdoor from the cord clamp and terminals. 4) Remove the top board. (Hex Ø4 × 10, 5 screws)</p> <p>2. How to attach 1) Attach the top board. (Hex Ø4 × 10, 5 screws) 2) Connect the power source cable and connecting cables between indoor and outdoor to the terminal, and fix them with the cord clamp.</p> <p>Note The power source cable and connecting cable between hydro and outdoor units must be fixed along the connecting piping by using a cable tie so that the cables do not contact the compressor, gas side valve, gas side piping and outlet pipe.</p> <p>3) Attach the front panel. (Hex Ø4 × 10, 2 screws)</p>	<p>Front panel</p>  <p>Top board</p> 

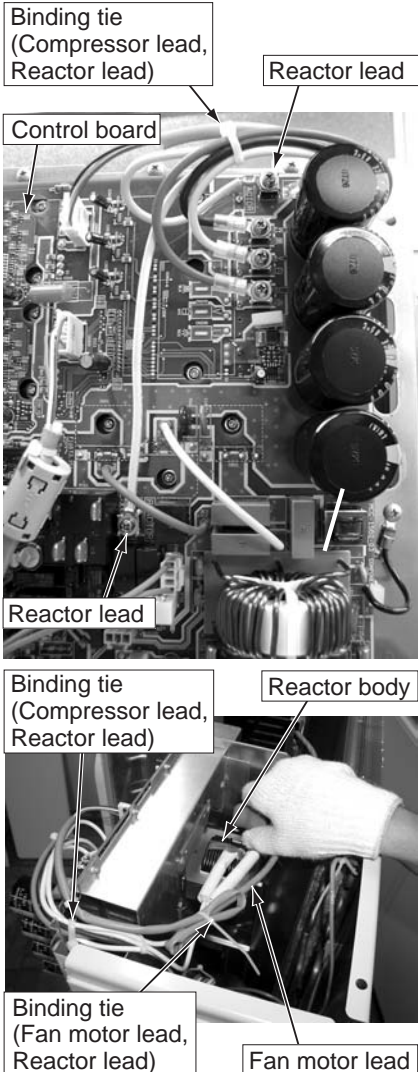

No.	Exchange parts name	Work procedure	Remarks
2	Outlet cabinet	<p>How to remove</p> <ol style="list-style-type: none"> 1) Perform the step 1-1. 2) Remove the screws of the outlet cabinet and parting board. (ST1T Ø4 × 8, 4 screws) 3) Remove the screws of the outlet cabinet and bottom board. (Hex Ø4 × 10, 2 screws) 4) Remove the screws of the outlet cabinet and motor base. (ST1T Ø4 × 8, 2 screws) 5) Remove the screws of the outlet cabinet and heat exchanger. (ST1T Ø4 × 8, 1 screws) 6) Remove the screws of the outlet cabinet and fin guard. (Hex Ø4 × 10, 2 screws) 	 <p>Heat exchanger Motor base Parting board Outlet cabinet Fin guard</p>
3	Side cabinet	<ol style="list-style-type: none"> 1) Perform the step 1-1. 2) Remove the screws that fixes the inverter assembly and the side cabinet. (ST1T Ø4 × 8, 2 screws) 3) Remove the screws of the side cabinet and valve fixing board. (ST1T Ø4 × 8, 2 screws) 4) Remove the screws of the side cabinet and piping panel (back). (Hex Ø4 × 10, 2 screws) 5) Remove the screws of the side cabinet and bottom board. (Hex Ø4 × 10, 1 screws) 6) Remove the screws of the side cabinet and fin guard (heat exchanger). (Hex Ø4 × 10, 5 screws) 7) Remove the side cabinet while shifting it upward (inverter hook). 	 <p>Inverter assembly Side cabinet Valve fixing board</p>

No.	Exchange parts name	Work procedure	Remarks
4	Electric parts replacement	<p>2. Reactor</p> <p>1) Perform the step 1-1.</p> <p>2) Remove the reactor lead connected to the control board. CN05 White, CN06 White</p> <p>3) Cut the binding tie that binds the compressor leads and fan motor leads.</p> <p>4) Remove the reactor. (Truss B tight screw $\varnothing 4 \times 6$, 2 screw)</p> <p>5) Attach a new reactor.</p> <p>Note) Be sure to bind the removed binding tie by using the commercially available binding tie. Make sure that the fan motor lead and the reactor body do not contact each other.</p>	 <p>The top photograph shows the internal wiring of the control board. A white binding tie is used to secure the compressor leads and reactor leads. Labels point to the 'Binding tie (Compressor lead, Reactor lead)', a 'Reactor lead', and the 'Control board'.</p> <p>The bottom photograph shows a person's hand, wearing a white glove, removing the reactor body. Labels indicate the 'Binding tie (Compressor lead, Reactor lead)', the 'Reactor body', another 'Binding tie (Fan motor lead, Reactor lead)', and the 'Fan motor lead'.</p>

No.	Exchange parts name	Work procedure	Remarks
5	Fan motor	<p>1) Perform the step 1-1 and step 2.</p> <p>2) Remove the fan motor and the flange nut that fixes the propeller fan.</p> <ul style="list-style-type: none"> • To loosen the flange nut, turn it clockwise. (Turn it counterclockwise for tightening.) <p>3) Remove the propeller fan.</p> <p>4) Remove the connector for fan motor from the inverter. (control board) (Remove the ferrite core of the lower fan motor to use it again for a new fan motor.)</p> <p>5) Remove the fan motor lead from the fan motor lead fixing rubber on the through hole of the parting board.</p> <p>6) Remove the fixed screws (4 for each) while holding the fan motor so that it does not drop.</p> <p>* Notes in assembling fan motor</p> <ul style="list-style-type: none"> • Tighten the flange nut in 4.95 N•m (50kgf•cm). • To prevent the fan motor lead from contacting the propeller fan, adjust the length of fan motor lead fixing rubber so that it does not slack. Attach the fan motor lead fixing rubber to the parting board so that the projection part is placed on the refrigerant cycle side. • Make sure that the reactor body and the fan motor lead do not contact each other. • Be sure to bind the removed binding tie by using the commercially available binding tie. • Be sure to re-attach the ferrite core of the lower fan motor. (Fix this with a commercially available binding tie.) <p>Note Fix the fan motor lead to the motor base using a metal tie so that the fan motor lead does not contact the propeller fan.</p>	

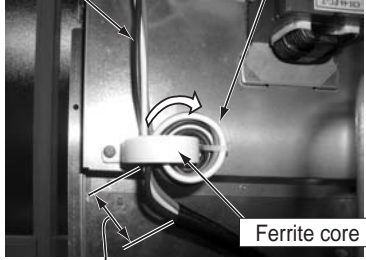
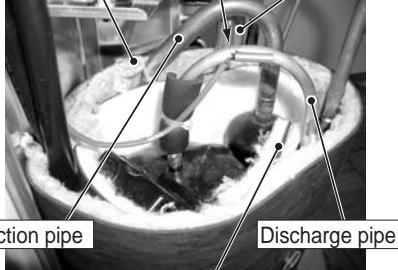
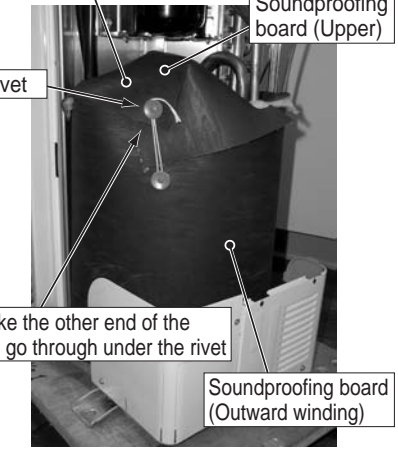
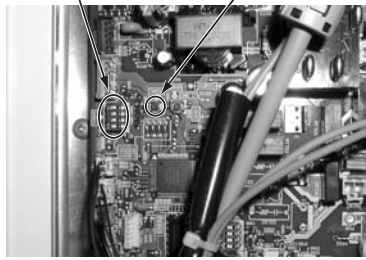
No.	Exchange parts name	Work procedure	Remarks
6	Compressor Compressor lead	<p>1. Remove defective compressor</p> <ol style="list-style-type: none"> 1) Perform refrigerant gas recovery. 2) Perform the step 1-1 and step 3. 3) Remove the piping panel (Front). Remove screws of the piping panel (Front) and bottom board. (Hex Ø4 × 10, 2 screws) Remove screws of the piping panel (Front and Back). (Hex Ø4 × 10, 1 screws) 4) Remove the piping panel (Back). Remove screws of the piping panel (Back) and bottom board. (Hex Ø4 × 10, 2 screws) 5) Remove the soundproofing board. (Upper, Inward winding, Outward winding) 6) Remove the compressor terminal cover, and then remove the compressor lead and compressor case thermostat. 7) Remove the TD sensor fixed to the discharge piping. 8) Remove the compressor lead. (Leave the ferrite core attached to the electric parts box.) Control board U: CN200 Red V: CN201 White W: CN202 Black 9) Remove the outlet and suction pipes connected to the compressor by using a burner. <p>WARNING When removing the piping by burning the solder, take enough care for a fire going off at the moment the wax melts if oil remains inside the piping.</p> <p>Note) Do not make fire flame contact with the 4-way valve and pulse motor valve. (This may cause an operation failure.)</p> <ol style="list-style-type: none"> 10) Pull out the discharge and suction pipes of the refrigerant cycle upward. 11) Remove the compressor nuts that fix the compressor to the bottom board. (3 nuts) 12) Pull the compressor out toward you. <p>Note) The compressor weighs 20 kg or more. Two people should be required to handle it.</p>	<p>Piping panel (Front)</p> <p>Piping panel (Back)</p> <p>Piping cover</p> <p>TD sensor</p> <p>Binding tie (for heat resistance)</p> <p>Compressor lead</p> <p>Compressor case thermostat</p> <p>Control board</p> <p>Compressor lead</p> <p>Compressor lead</p> <p>Ferrite core</p> <p>Remove (Outlet pipe)</p> <p>Remove (Suction pipe)</p> <p>450</p> <p>Compressor nut (3 nuts)</p>

No.	Exchange parts name	Work procedure	Remarks
6	Compressor Compressor lead	<p>2. Attach the compressor</p> <p>1) Attach the compressor in the reverse order of the removal.</p> <p>Note)</p> <ul style="list-style-type: none"> • Be sure to replace the compressor lead after the compressor replacement. (Compressor lead spare parts code: 43160591) At this time, wind the ferrite core with the compressor lead for 4 times. • Attach the soundproofing board (Inward winding, Outward winding), as shown in the right figure, through between the compressor and between the piping and parting board. • Fix the TD sensor with a commercially available heat resistant binding tie through the piping cover so that the sensor do not contact the discharge pipe. <p>3) Vacuuming</p> <p>1) Connect the vacuum pump to the charge port and check joint of the gas piping valve to operate the vacuum pump.</p> <p>2) Perform vacuuming until the vacuum low pressure gauge shows 1(mmHg).</p> <p>Note)</p> <p>Open fully the pulse motor valve before vacuuming. With the valve closed, vacuuming between the outdoor unit liquid valve and the pulse motor valve may fail.</p> <p>How to make pulse motor valve forcible full open</p> <ul style="list-style-type: none"> • Turn on the electric leakage breaker. • Set the SW804 dip switch 1 and 3 on the outdoor unit control board to ON. • Press SW801 on the outdoor unit control board for 1 second or longer. • After pressing SW801 for 1 second or longer, turn off the electric leakage breaker within 2 minutes. <p>4. Charge refrigerant</p> <p>1) Add refrigerant whose amount is defined according to the piping length from the valve charge port. (HWS-1102H, 1402H : 2.7kg)</p>	<p>Wind ferrite core with compressor lead for 4 times</p>  <p>0 to 50 (Compressor lead positioning standard)</p> <p>Place soundproofing board (Outward winding) through between suction pipe and header pipe</p> <p>Overlap soundproofing board (Outward winding) at this position</p>  <p>Overlap soundproofing board (Inward winding) at this position through between compressor, outlet pipe, and suction pipe</p> <p>Do not make space between soundproofing boards (Upper and Outward winding)</p>  <p>Make the other end of the line go through under the rivet</p> 

No.	Exchange parts name	Work procedure	Remarks
7	Pulse motor valve coil	<p>1. How to remove</p> <ol style="list-style-type: none"> 1) Perform the step 1-1. 2) Remove the coil from the pulse motor valve body by pulling upward while rotating the coil. <p>2. How to attach</p> <ol style="list-style-type: none"> 1) Fix the coil by exactly adjusting the coil positioning projection to the recess of the pulse motor valve body. 	<p>Recess Pulse motor valve body</p>  <p>Positioning projection Motorized control valve coil</p>
8	Fan guard	<p>1. How to remove</p> <ol style="list-style-type: none"> 1) Perform the step 1-1 and step 2. <p>Note Perform a replacement work on cardboard or cloth to prevent the product from being damaged.</p> <ol style="list-style-type: none"> 2) Remove the outlet cabinet and put with the fan guard side down. 3) Release the hooks (8 positions) of the fan guard. <p>2. How to attach</p> <ol style="list-style-type: none"> 1) Press the hooks (8 positions) with hands from the front side to fix them. <p>Note Check that all the hooks are fixed to the given positions.</p>	<p>Fan guard Bellmouth Outlet cabinet</p>  <p>Hooks</p>

12 Periodic Inspection Items

For a long-term safe operation of this equipment, perform periodic inspection and parts replacement.

<Inspection items>

Hydro unit (HWS-802**-E, 1402**-E)	Frequency	Periodic inspection details
1. Insulation measurement (Power source circuit/ Heater circuit)	Annually	Insulation measurement with a mega tester
2. Power source measurement (No-load voltage)	Annually	Electronic voltage measurement: 230V ±23V
3. Operation check	Annually	Hot water supply/ Heating/ Cooling operation check with remote controller
4. Refrigerant leakage/ Water leakage inspection	Annually	Visual inspection and check with a leak tester: No leakage must be found
5. Water heat exchanger inspection (Internal dirt and clogging)	Annually	Checking for water dirtiness in a closed cycle, Cleaning
6. Inlet/ Outlet water temperature measurement	Annually	Temperature measurement: Temperature measurement during an operation
7. Circulation pump inspection	Annually	No leakage or abnormal noise must be found (Replacement every 10 years: Charged)
8. Air vent valve inspection	Annually	Water leakage, Air vent
9. Expansion vessel	Annually	Visual check for charge pressure abnormality, water leakage, or corrosion
10. Heater assembly	Annually	Check for appearance damage, deformation, or loose terminal
11. Flow switch	Annually	Operation check while running
12. Manometer	Annually	Water leakage, water pressure check
13. Safety valve	Annually	Water leakage, Appearance check, Drainage check
14. Water heat exchanger control board, Terminal block	Annually	Check for loose connector and connecting terminal

Outdoor unit (HWS-802H-E, 1102H-E, 1402H-E)	Frequency	Periodic inspection details
1. Insulation measurement (Power source circuit/ Compressor)	Annually	Insulation measurement with a mega tester
2. Power source measurement (No-load voltage/ Rated operation)	Annually	Electronic voltage measurement: 230V ±23V
3. Operation frequency (Outdoor unit operation check)	Annually	Frequency check by rated operation (See 10-13)
4. Refrigerant leakage inspection	Annually	Visual inspection and check connection with a leak tester: No leakage must be found
5. Air heat exchanger inspection (Dirt and clogging)	Annually	Visual inspection, Clear clogging
6. Fan inspection (Scratch, damage)	Annually	Check for scratches or damages to the fan or abnormal motor sound
7. Cycle parts (Compressor, 4-way valve, Pulse motor valve)	Annually Annually	Operation check by trial run
8. Inverter control board, Terminal block	Annually	Check for loose connector and connecting terminal

Hot water cylinder (HWS-150CSHM3-E(-UK), 210CSHM3-E(-UK), 300CSHM3-E(-UK))	Frequency	Periodic inspection details
1. Insulation measurement (Power source circuit)	Annually	Insulation measurement with a mega tester
2. Power source measurement (No-load voltage)	Annually	Electronic voltage measurement: 230V ±23V
3. Water leakage inspection	Annually	Visual inspection for leakage: No leakage must be found
4. Terminal block	Annually	Check for loose connector and connecting terminal
5. Heater assembly	Annually	Check for appearance damage, deformation, or loose terminal
6. Temperature, Pressure relief valve (Specification for UK only)	Annually	Drainage check

13 Part Exploded View, Part List

Hydro Unit

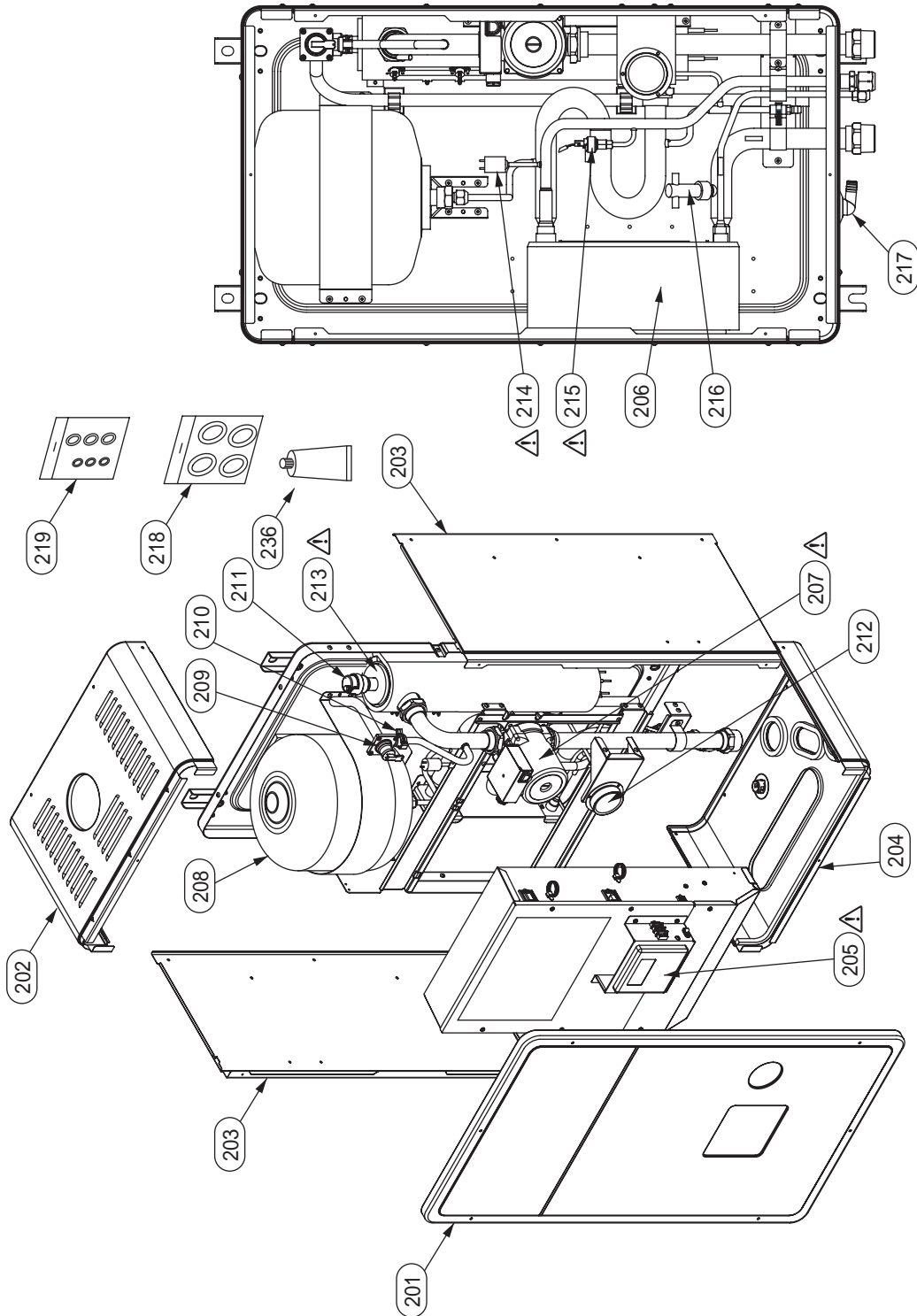

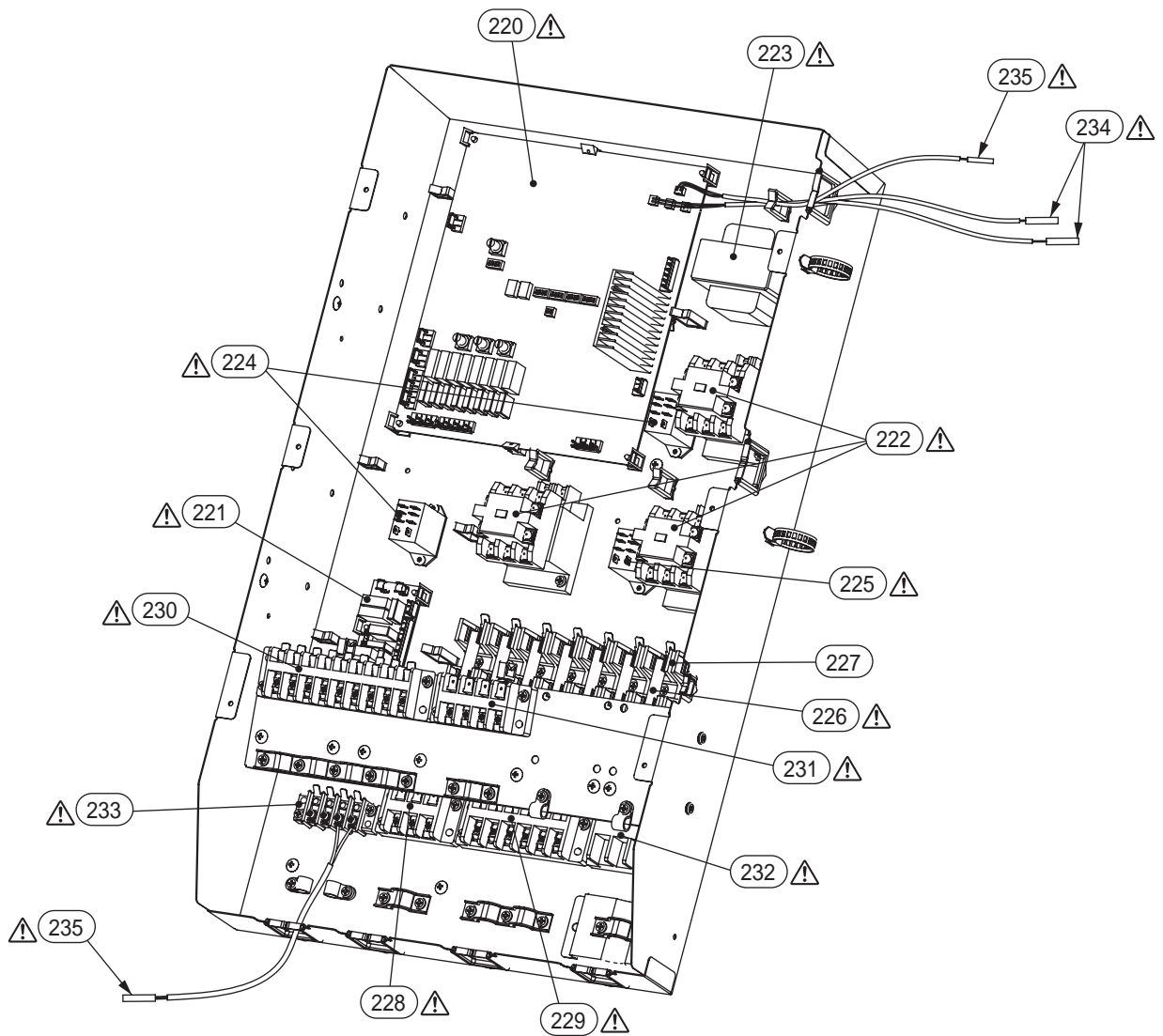

Safety ⚠	Location No.	Part No.	Description	Number of pieces per unit				
				HWS- 1402XW HM3-E	HWS- 1402XW HT6-E	HWS- 1402XW HT9-E	HWS- 802XWH M3-E	HWS- 802XWH T6-E
	201	37500802	CABINET, FRONT	1	1	1	1	1
	202	37500800	PLATE, UP	1	1	1	1	1
	203	37500801	PLATE, SIDE	2	2	2	2	2
	204	37500803	PLATE, DN, ASSY	1	1	1	1	1
⚠	205	37566705	REMOTE CONTROLLER	1	1	1	1	1
	206	37546861	PIPE ASSY, WATER HEAT EXCHANGER	1	1	1		
	206	37546862	PIPE ASSY, WATER HEAT EXCHANGER				1	1
⚠	207	37541733	PUMP, WATER, ASSY				1	1
⚠	207	37541734	PUMP, WATER, ASSY	1	1	1		
	208	37542708	VESSEL, EXPANSION	1	1	1	1	1
	209	37547757	VALVE, PRESSURE RELIEF	1	1	1	1	1
	210	37519776	FASTENER, QUICK	1	1	1	1	1
	211	37547756	VALVE, AIR VENT	1	1	1	1	1
	212	37543706	METER, PRESSURE	1	1	1	1	1
⚠	213	37545713	HEATER ASSY	1			1	
⚠	213	37545714	HEATER ASSY		1			1
⚠	213	37545715	HEATER ASSY			1		
⚠	214	43151273	SWITCH, PRESSURE	1	1	1	1	1
⚠	215	37551736	SENSOR, LOW PRESSURE	1	1	1	1	1
	216	37551735	SWITCH, FLOW	1	1	1	1	1
	217	43032441	NIPPLE, DRAIN	1	1	1	1	1
	218	37595721	PACKING, ASSY	1	1	1	1	1
	219	37595720	RING, O, ASSY	1	1	1	1	1
⚠	220	4306V226	PC BOARD ASSY	1	1	1	1	1
⚠	221	4316V338	PC BOARD ASSY	1	1	1	1	1
⚠	222	43152401	CONTACTOR, MAGNETIC	2	3	3	2	3
⚠	223	43158187	TRANSFORMER	1	1	1	1	1
⚠	224	43154156	RELAY, LY-1F	1	2	2	1	2
⚠	225	43054107	RELAY, LY1F	1	1	1	1	1
⚠	226	43160297	FUSE	4	6	8	4	6
	227	43060059	FUSE, HOLDER	4	6	8	4	6
⚠	228	43160565	TERMINAL BLOCK, 3P, 20A	1	1	1	1	1
⚠	229	43160566	TERMINAL BLOCK, 6P, 20A	1	1	1	1	1
⚠	230	4306A130	TERMINAL BLOCK, 9P, 20A	1	1	1	1	1
⚠	231	43160576	TERMINAL BLOCK, 4P, 20A	1	1	1	1	1
⚠	232	43160579	TERMINAL	1	1	1	1	1
⚠	233	43160561	TERMINAL, 4P	1	1	1	1	1
⚠	234	43050425	SENSOR ASSY, SERVICE	3	3	3	3	3
⚠	235	43150320	SENSOR ASSY, SERVICE	2	2	2	2	2
	236	37595722	GASKET, LIQUID	1	1	1	1	1

Outdoor Unit (HWS-802H-E)

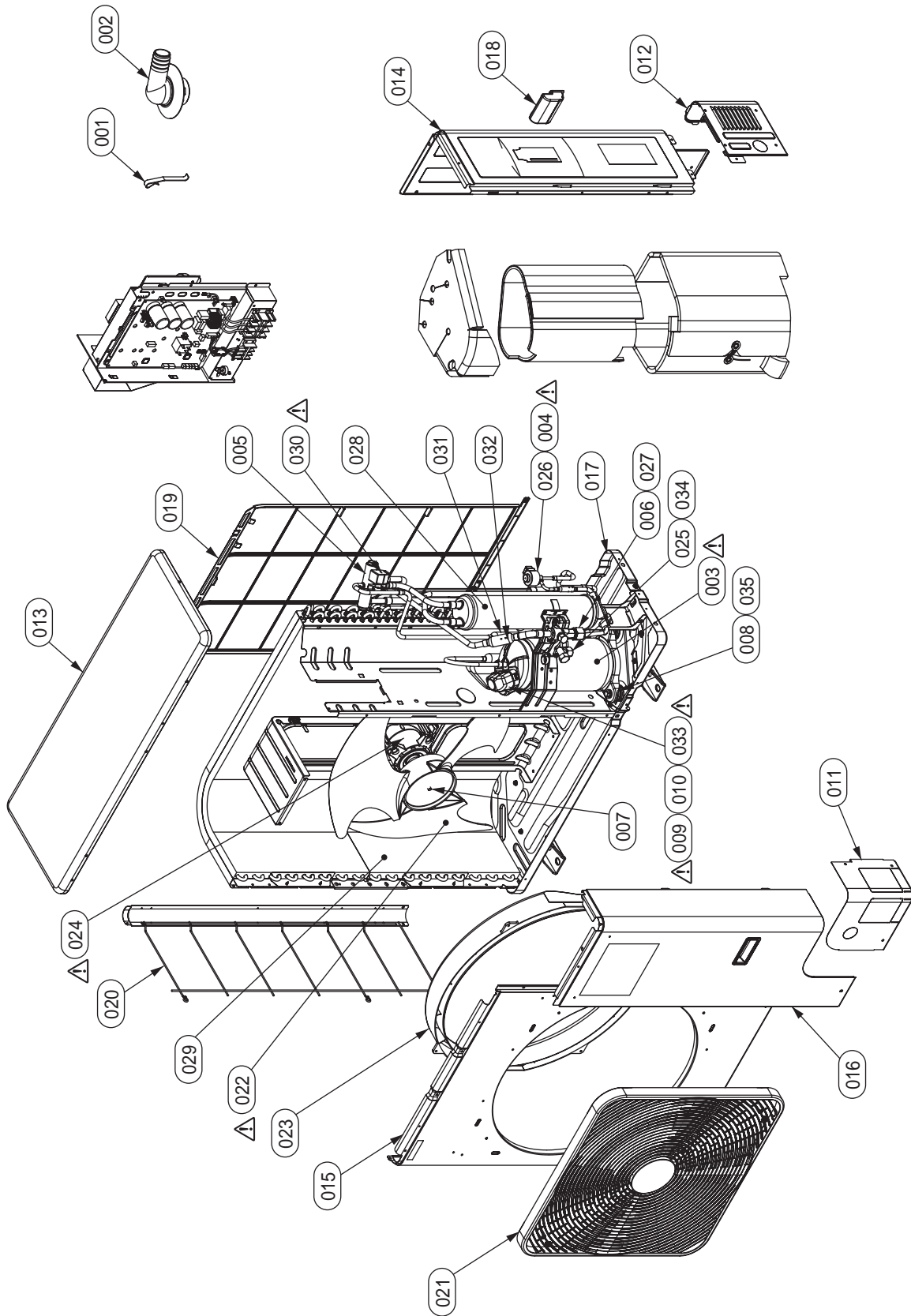

Safety ⚠	Location No.	Part No.	Description	Number of pieces per unit
				HWS-802H-E
	001	43019904	HOLDER, SENSOR	1
	002	43032441	NIPPLE, DRAIN	1
⚠	003	43041798	COMPRESSOR, DA220A2F-22L	1
⚠	004	43046493	COIL, PMV	1
	005	43046451	VALVE, 4-WAY, STF-0218G	1
	006	43047246	BONNET, 3/8 IN	1
	007	43047669	NUT, FLANGE	1
	008	43049739	CUSHION, RUBBER	3
⚠	009	43050407	THERMOSTAT, BIMETAL	1
	010	43063317	HOLDER, THERMOSTAT	1
	011	43100437	PANEL, FRONT, PIPING	1
	012	43100438	PANEL, BACK, PIPING	1
	013	43100440	PLATE, ROOF	1
	014	43100452	PANEL, SIDE	1
	015	43100453	PANEL, AIR OUTLET	1
	016	43100454	PANEL, FRONT	1
	017	43100455	BASE ASSY	1
	018	43107276	HANGER	2
	019	43107277	GUARD, FIN, BACK	1
	020	43107278	GUARD, FIN, SIDE	1
	021	43109422	GUARD, FAN	1
⚠	022	43120244	FAN, PROPELLER, PB521	1
	023	43122113	BELL MOUTH	1
⚠	024	4312C042	MOTOR, FAN, ICF-280-A60-1	1
	025	43146686	VALVE, PACKED, 9.52	1
	026	43146695	VALVE, PULSE, MODULATING	1
	027	43146724	VALVE, BALL, SBV-JA5GTC-1, R0HS	1
	028	43148232	ACCUMULATOR, ASSY	1
	029	4314G278	CONDENSER ASSY	1
⚠	030	4314N024	COIL, VALVE, 4WAY, VHV-01AP552B1	1
	031	4314Q031	STRAINER	1
	032	4314Q056	STRAINER	1
⚠	033	43160591	LEAD ASSY, COMPRESSOR	1
	034	43194029	BONNET	1
	035	43197183	BOLT, COMPRESSOR	3

Inverter Assembly (HWS-802H-E)

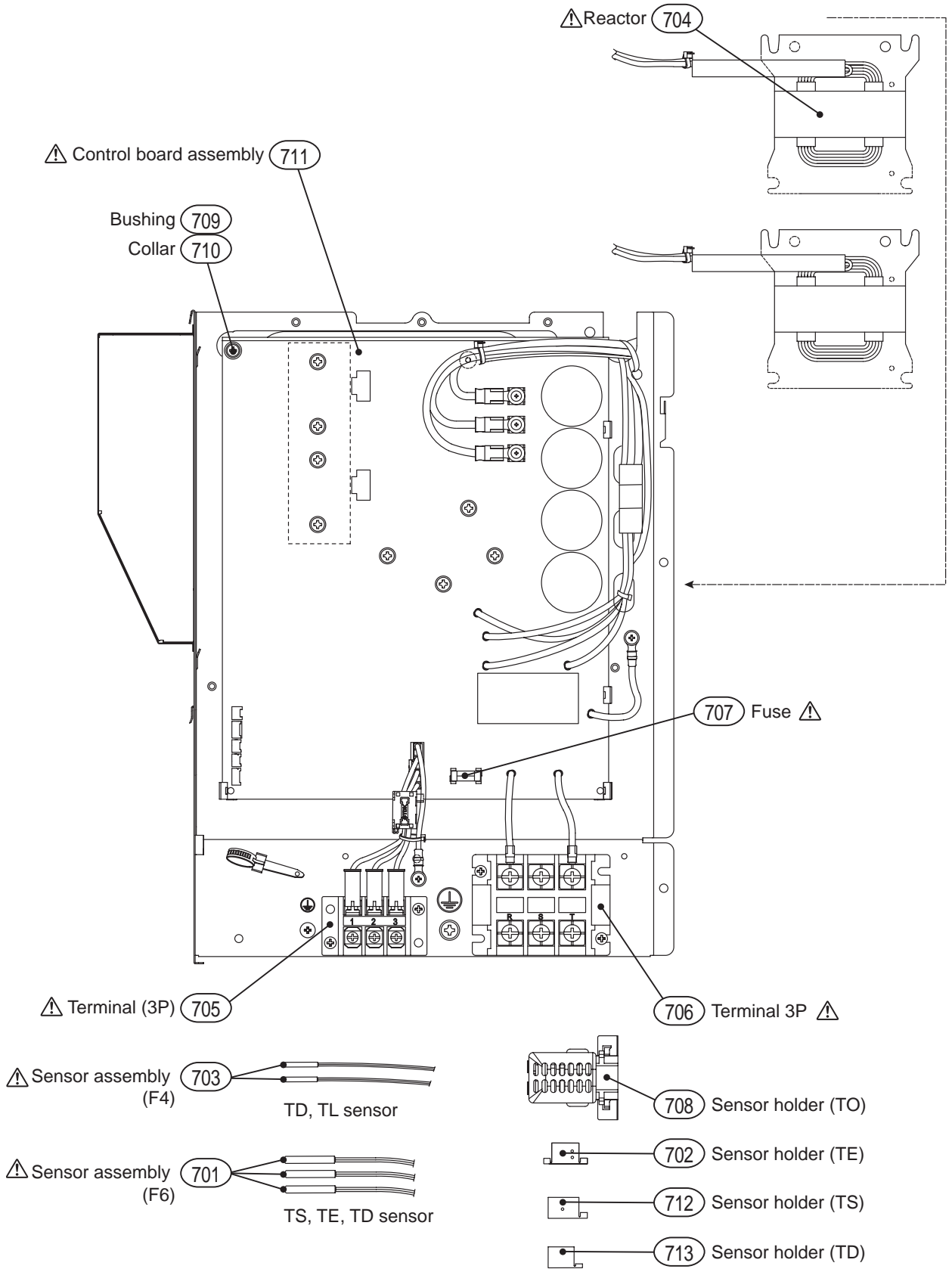

Safety ⚠	Location No.	Part No.	Description	Number of pieces per unit
				HWS-802H-E
⚠	701	43050425	SENSOR ASSY, SERVICE	3
	702	43063325	HOLDER, SENSOR	1
⚠	703	43150319	SENSOR ASSY, SERVICE	2
⚠	704	43155188	REACTOR, CH-56-2Z-T	2
⚠	705	43160565	TERMINAL BLOCK, 3P, 20A	1
⚠	706	43160581	TERMINAL	1
⚠	707	43160589	FUSE	1
	708	43163055	HOLDER, SENSOR	1
	709	43163059	SPACER, BUSH	1
	710	43163060	SPACER, COLLAR	1
⚠	711	4316V387	PC BOARD ASSY, MCC-1571	1
	712	43063322	HOLDER,SENSOR	1
	713	43063321	HOLDER,SENSOR	1

Outdoor Unit (HWS-1102H-E, 1402H-E)

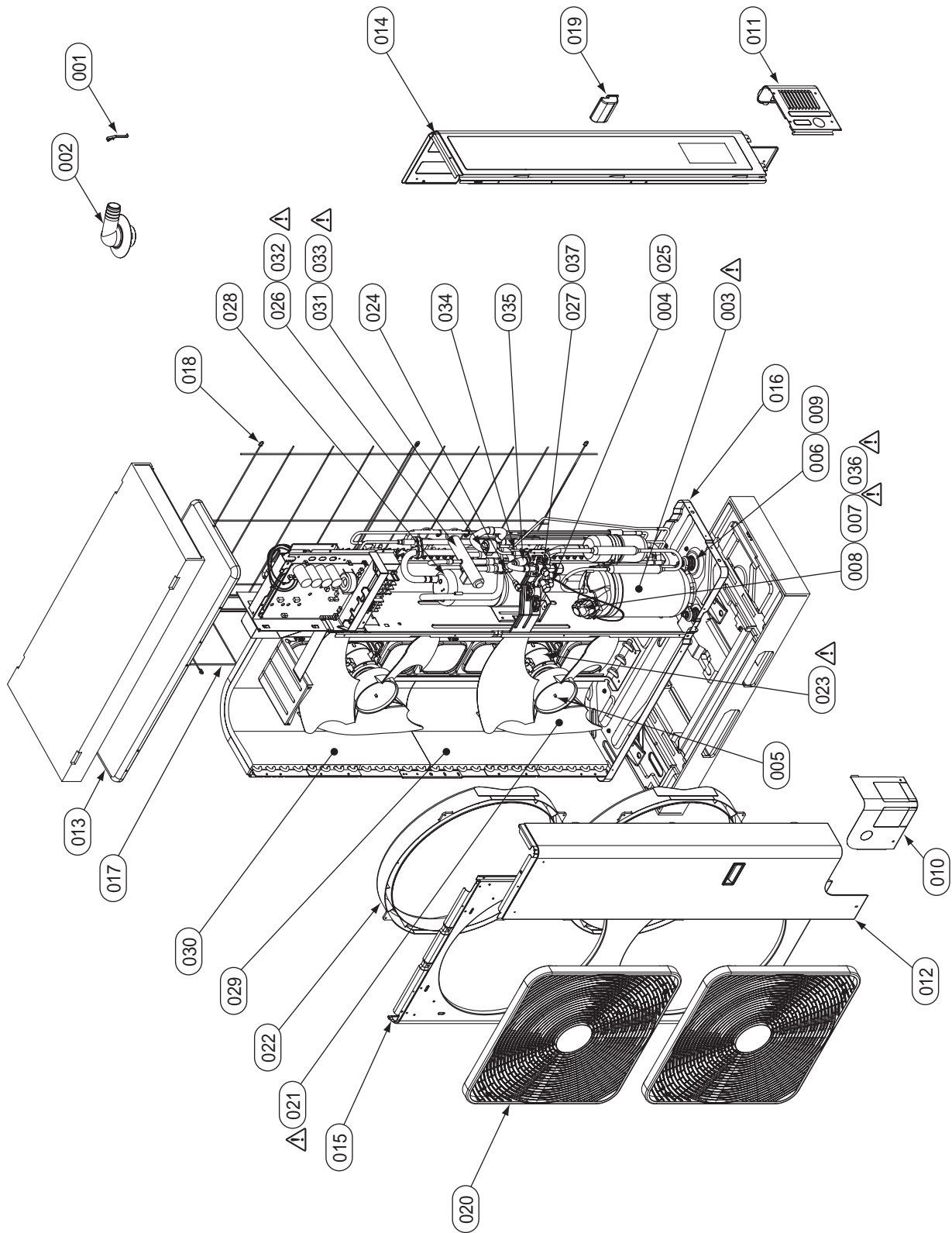

Safety ⚠	Location No.	Part No.	Description	Number of pieces per unit	
				HWS-1102H-E	HWS-1402H-E
	001	43019904	HOLDER, SENSOR	3	3
	002	43032441	NIPPLE, DRAIN	1	1
⚠	003	43041794	COMPRESSOR, DA422A3F-25M	1	1
	004	43047246	BONNET, 3/8 IN	1	1
	005	43047669	NUT, FLANGE	2	2
	006	43049739	CUSHION, RUBBER	3	3
⚠	007	43050407	THERMOSTAT,BIMETAL	1	1
	008	43063317	HOLDER,THERMOSTAT	1	1
	009	43097212	NUT	3	3
	010	43100437	PANEL, FRONT, PIPING	1	1
	011	43100438	PANEL, BACK, PIPING	1	1
	012	43100439	PANEL, FRONT	1	1
	013	43100440	PLATE, ROOF	1	1
	014	43100441	PANEL, SIDE	1	1
	015	43100442	PANEL, AIR OUTLET	1	1
	016	43100443	BASE ASSY	1	1
	017	43107274	GUARD, FIN, SIDE	1	1
	018	43107275	GUARD, FIN, BACK	1	1
	019	43107276	HANGER	3	3
	020	43109422	GUARD, FAN	2	2
⚠	021	43120244	FAN, PROPELLER, PB521	2	2
	022	43122113	BELL MOUTH	2	2
⚠	023	4312C037	MOTOR, FAN, ICF-280-A100-1	2	2
	024	43146676	JOINT,CHECK	1	1
	025	43146686	VALVE, PACKED, 9.52	1	1
	026	43146687	VALVE, 4-WAY, STF-0401G	1	1
	027	43146724	VALVE, BALL, SBV-JA5GTC-1, R0HS	1	1
	028	43148170	ACCUMULATOR ASS'Y	1	1
	029	4314G266	CONDENSER ASSY, DOWN	1	1
	030	4314G269	CONDENSER ASSY, UP	1	1
	031	4314N023	VALVE, PLUS, MODULAING, UKV-25D100	1	1
⚠	032	4314N024	COIL, VALVE, 4WAY, VHV-01AP552B1	1	1
⚠	033	4314N025	COIL, PMV, UKV-A038	1	1
	034	4314Q031	STRAINER	1	1
	035	4314Q032	STRAINER	1	1
⚠	036	43160591	LEAD ASSY, COMPRESSOR	1	1
	037	43194029	BONNET	1	1

Inverter Assembly (HWS-1102H-E, 1402H-E)

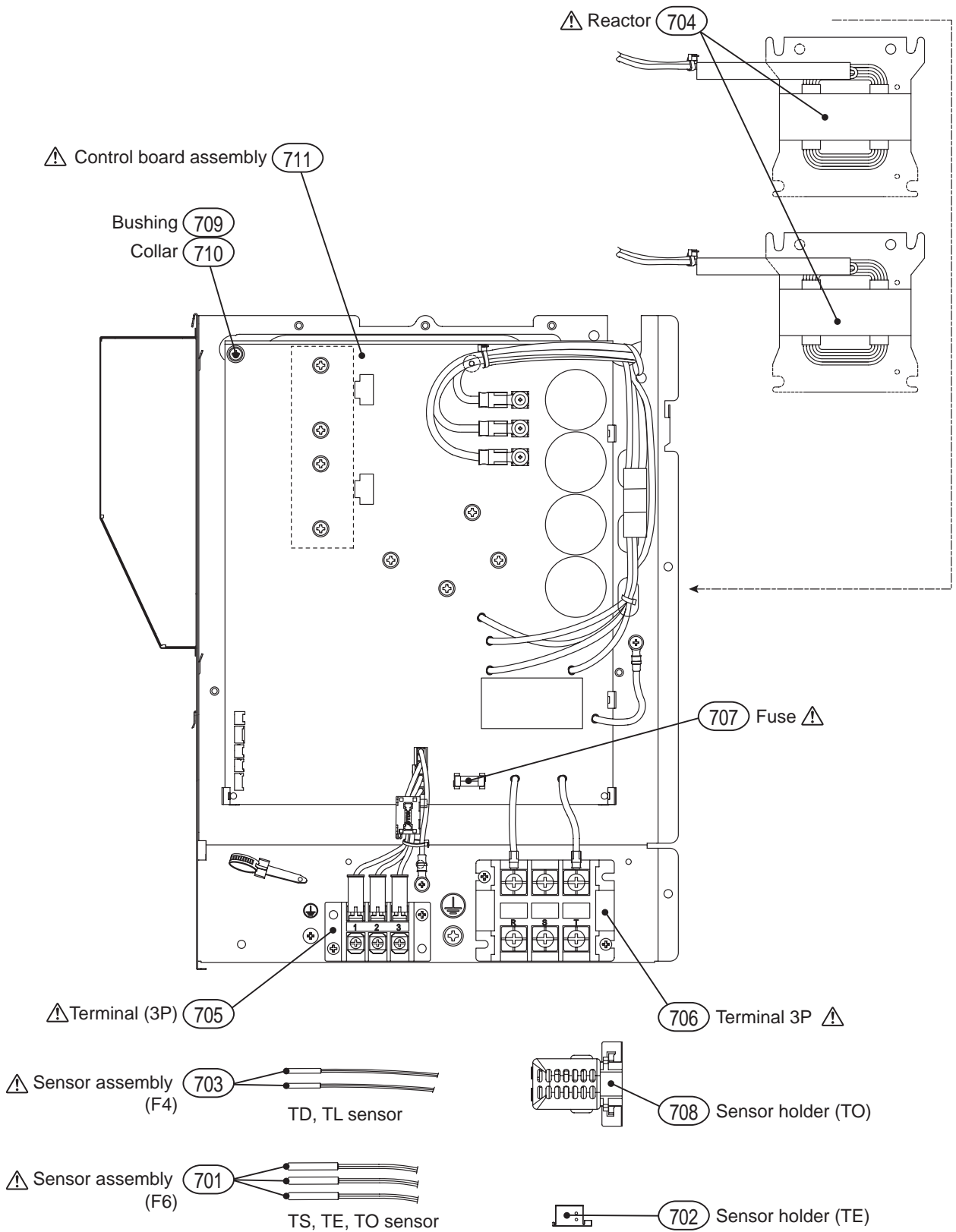

Safety ⚠	Location No.	Part No.	Description	Number of pieces per unit	
				HWS-1102H-E	HWS-1402H-E
⚠	701	43050425	SENSOR ASSY, SERVICE	3	3
	702	43063325	HOLDER, SENSOR	1	1
⚠	703	43150319	SENSOR ASSY, SERVICE	2	2
⚠	704	43158190	REACTOR	2	2
⚠	705	43160565	TERMINAL BLOCK, 3P, 20A	1	1
⚠	706	43160581	TERMINAL	1	1
⚠	707	43160589	FUSE	1	1
	708	43163055	HOLDER, SENSOR	1	1
	709	43163059	SPACER, BUSH	1	1
	710	43163060	SPACER, COLLAR	1	1
⚠	711	4316V357	PC BOARD ASSY, MCC-1571	1	1

TOSHIBA CARRIER CORPORATION
23-17, TAKANAWA 3-CHOME, MINATOKU, TOKYO 108-0074, JAPAN