

# GPS Tracking Watch Manual



## 1. Products Summary

### 1.1 Foreword

Welcome to use our GPS tracking watch, in order to help you know this products and operate the devices professional as soon as possible,we provide this detailed instruction manual with products,which include products introduction,usage method and notice,so that you can use the products function better.

### 1.2 GPS tracking watch functions

➤ GPS satellite and LBS location	➤ History playback
➤ SOS emergency call	➤ remote monitoring
➤ Family number speedy dialing	➤ SMS tracking location
➤ PC web real-time tracking	➤ Geo-fence

## 2. Technical specifications

Name	Parameter
Item	GPS tracking device
Battery Volt	3.7V
Charging Volt	DC5V
Watch Size	32.5*23 12.3mm
Working Temperature	-20℃~+70℃
Working frequency	GSM 850/900/1800/1900 MH
Sensitivity	GSM -165dBm /GPRS CS4 -102dBm
Location query mode	PC platform, SMS, etc

## 3. Attention

Before using this GPS device, please notice the instructions as below:

- Make sure the SIM card is standard GSM network format, currently we don't support 3G network
- Make sure the SIM card opened GPRS function, we suggest to use a GPRS packages (saving cost)
- Make sure the account of SIM card has enough money;
- Make sure the SIM card does not set a password (PIN1, etc.);
- Please check the SIM card SMS inbox, if full, we suggest to delete some, otherwise the SIM card can not receive GPS tracking SMS;
- Please make sure the SIM card opened the caller ID display function;
- Please contact your telecom operator for APN information and setting the APN on the device. The factory default APN setting is CMNET.
- Before tracking on the PC-WEB platform, please use the cell phone to set up the SOS phone number and related instructions.

## 4. Introduction Of Products

### 4.1 Product appearance and key descriptions

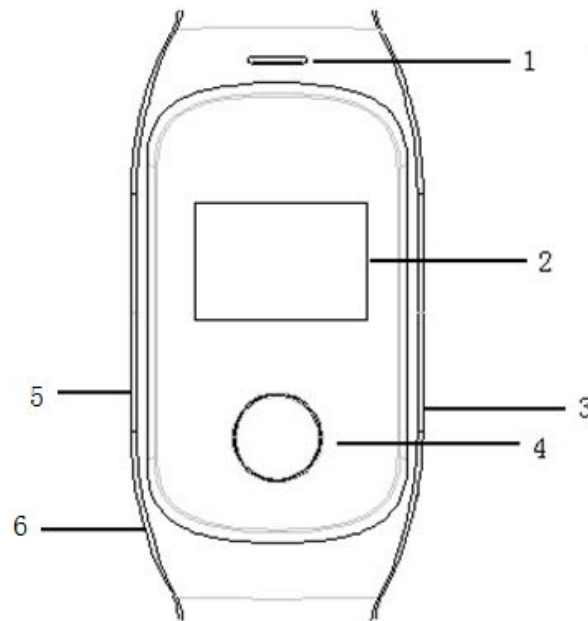



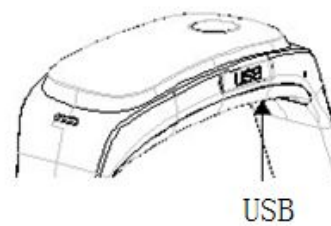
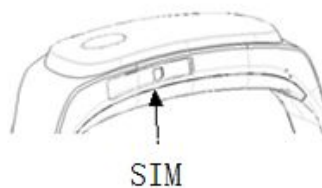

- 1: Speaker
- 2: Screen display
- 3: Sim card slot
- 4: SOS/power on/off

- 5: USB port
- 6: Mic



### 4.2 Screen Icon Descriptions

-  Battery charge status
-  Network signal strength

-  22:20 Display Time
-  GPS working

### 4.3 operating method

Power on:

Long press the Switch key for 3 seconds then relaxed , the watch will power on

**Power off:**

1: If not insert the sim card,Long press the Switch key for 3 seconds then relaxed , the watch will power off.

2:If have insert the sim card, use admin/sos phone send SMS: “ 00” to the watch to power off.

**SOS call:** After insert the sim card, long press SOS button, will call SOS phone .

## 5. Set Command

There are two ways to set the commands.

Method 1: Set SMS to set the watch.

Method 2: Download and install APK software in the android smart mobile phone, use software to set the watch.

Note: Only need choose one method, cannot use both method at same time.

### Method 1: SMS Settings

#### (5.1) Setting SOS phone numbers

Format: **1SOS#0000#phone number**

**2SOS#0000#phone number**

**3SOS#0000#phone number**

Total can set three SOS phone numbers. "0000" is the default password of the watch. This password is very important, can change the SOS phone number in any normal phone when have this password. ( Change the password please see below: " 5.8 Change password".)

For example:

**Use the normal phone send SMS to the watch:**



**1SOS#0000#13800138000**

The watch will reply SMS: set 1SOS ok, then phone number 13800138000 will become the watch's 1SOS(admin)number.

**2SOS#0000#13800138001**

The watch will reply SMS : set 2SOS ok, then phone number 13800138001 will become the watch's 2SOS(guardian 1)number.

**3SOS#0000#13800138002**

The watch will reply SMS : set 3SOS ok, then phone number 13800138002 will become the watch's 3SOS(guardian 2)number.

**Also you can just set 1 or 2 SOS numbers.**

This SMS also can change the SOS phone number. Fox example:

**Use the normal phone send SMS to the watch:**

**1SOS#0000#13800138003**

**The 1SOS phone number of the watch will update to be 13800138003.**

After setting SOS phone numbers successfully, long time press SOS button of the tracking watch, it will auto call 1SOS phone number, when the 1SOS does not answer or refused to answer the calling, the tracking watch will auto call 2SOS, when 2SOS not answer or refused to answer the calling, the watch will auto call 3SOS. It will loop calling 3 times. After press SOS button, the watch will auto send a SMS : "SOS+detail address" to the 1SOS phone.

Note: **Below all this SMS command must send by SOS phone number**

**(5.2) Get tracking link of position**

Use any SOS phone number send this SMS to the watch:

**SMS format: 01**

This command need the watch outside and can get the GPS signal.

If have GPS signal will reply a map link SMS to SOS phone NO.



If not have GPS signal, the watch will auto use LBS model for tracking, reply LBS detail address SMS.

**LBS:** Location Based Service, tracking by base station via GRPS.

### (5.3) Call back function

Use any SOS phone number send this SMS to the watch:

**SMS format: 02**

the watch will auto call back to this sos phone number to have a two-way conversation(can talk with each other).

### (5.4) Listen function

Use any SOS phone number send this SMS to the watch:

**SMS format: 03**

After send out this SMS, the watch will call back to this SOS phone number automatically to have a one-way conversation. This SOS phone can monitor the sound around the watch, but the watch can not hear any sound. The watch is auto locked (all buttons and screen failure and no response.)

### (5.5) Low battery automatic alarm

Use any SOS phone number send this SMS to the watch:

**SMS format: 04**

**Feedback message: set low battery ok!**

When the watch show low battery, there will be a message sent to **1SOS phone number** automatically.

### (5.6) Single time get watch's position

After APN set successful, you can use any SOS phone number send this SMS to the watch:

**SMS format: 05**

The Watch will reply the detail position with street name to this SOS phone number by SMS.

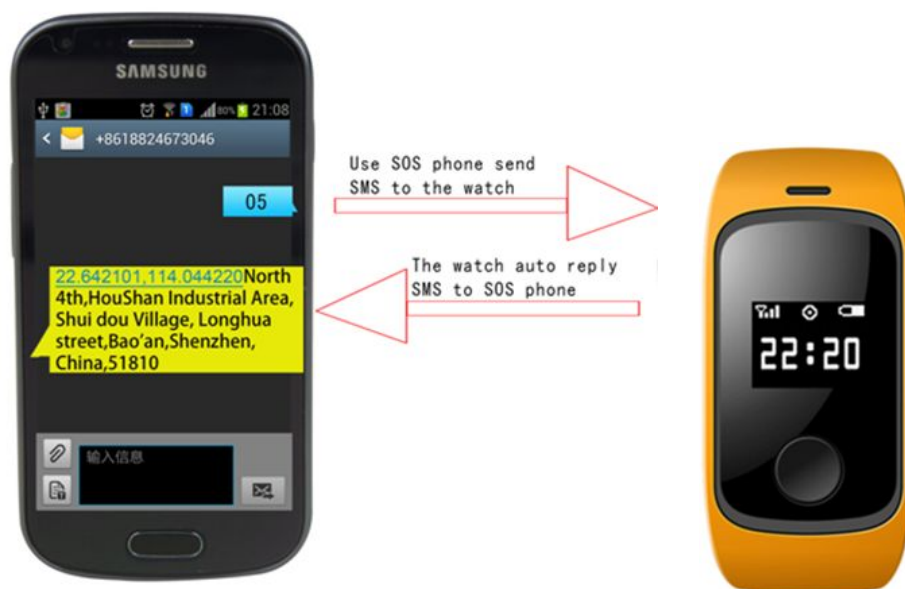

**(5.7) Set tracking on website in real time**

Use any SOS phone number send this SMS to the watch:

**SMS format: 08# interval time(seconds)**

For example:Send the SMS to the watch: **08#60**

Feedback message: set 08 OK

60 is the interval time, means every 60 seconds the watch will update the position data on website.

This SMS command will let the GPS always working, the battery will running fast, if no need see the website tracking in real time, please shut off this function to save the battery.

**Send this SMS to shut off this function: 08#0**

Feedback message : set off

**And every time turn off the watch, need resend this SMS to get real time tracking if need this function(to save battery purpose)**

**(5.8) Password change**

Format: 066#old password#new password

**SOS Number send SMS to watch, for example: 066#0000#1234**

Feedback: set psw ok!

Password changed to:1234. Default password is 0000. Only 1SOS can set and change this command

**(5.9) Set APN** (No need to set APN in china, But in HK , Taiwan, foreign country should set the local service APN)

Format:06#0000#account name#Access Point Name#user name#user password

**1SOS send SMS to the watch, for example:**

**06#0000#chana wap#cmwap#hhh#123**

Feedback:: set apn ok!

Only 1SOS can set and change this command

#### **(5.10) Call Management**

SOS numbers send SMS to watch for example: **77**

When the watch receive this command, any other numbers cannot call except the three SOS numbers can call the watch

SOS numbers send SMS to watch for example: **99**

Allow all the normal phone numbers call the watch

#### **(5.11) Power off the watch**

SOS numbers send SMS to watch for example: **00**

When the watch get this SMS, it's will auto power off.

#### **(5.12) Check IMEI code**

SOS numbers send SMS to watch for example: **IMEI**

When the watch get this SMS, it's will auto reply SMS( watch's IMEI code) to sos phone.

#### **(5.13) Set time zone (Default time zone set is +8)**

SMS command: **z,time zone#**

For example: z,+8#

#### **(5.14) Restore factory setting**

1SOS send sms to the watch, for example: 77#99#0000

Then clean all setting include user information and so on

### **Method 2, mobile phone APK settings**

**(5.15) Android os smart mobile phone----- Settings--Security-- "Unknown Sources",allow it .**



<  Security

## Set up SIM card lock

### Passwords

**Make passwords visible**



### Device administration

## Device administrators

View or disable device administrators.

## Unknown sources

Allow installation of apps from sources other than the Play Store



### Credential storage

## Trusted credentials

Display trusted CA certificates.

## Install from device storage

Install certificates from storage.

## Clear credentials

Remove all certificates.

(5.16) APK software web,download from the web: [www.gps1166.com](http://www.gps1166.com)  
Or scan it from RQ Code.



(5.15) Add Device Management

## WatchInformation



Add

Click "ADD"

 **Adddevice**

Name

1GPS

SIM

18824673047

Watch Password

0000

**Confirm**

**Cancle**

For example:

Fill in the watch name " 1GPS", If you watch the phone number is 18824673047, default password is 0000 and press OK.

As showing:

## WatchInformation













1GPS



Add

Open “1GPS”

(5.16) SOS Setting

	Send instruction set	Set
	Positioning queries	
	Back to the dial	
	SOS Set the number	
	Monitoring function	
	A single location	
	Computer location platform tracking monitoring watch position	
	Low battery alarm automatically	
	The electricity management	
	Speed dial Tel key Settings	

The watch can set up three SOS numbers, 1SOS is admin number.  
 Eg: SOS number is 13800138000, direct input 13800138000 will be OK.

When the watch set up SOS numbers well, long press the SOS button will automatically dial 1SOS number. If 1SOS numbers do not answer the phone or reject a call, the watch will automatically give a call 2SOS number when 2SOS numbers do not answer the phone or reject phone, the watch will automatically give 3SOS number to call, this cycle three times. When the SOS number is not answered or the call is completed, the watch will automatically send: "SOS + current watch the latest location information" to SOS1 phone number.

(5.17) Online platform tracking the watch's location

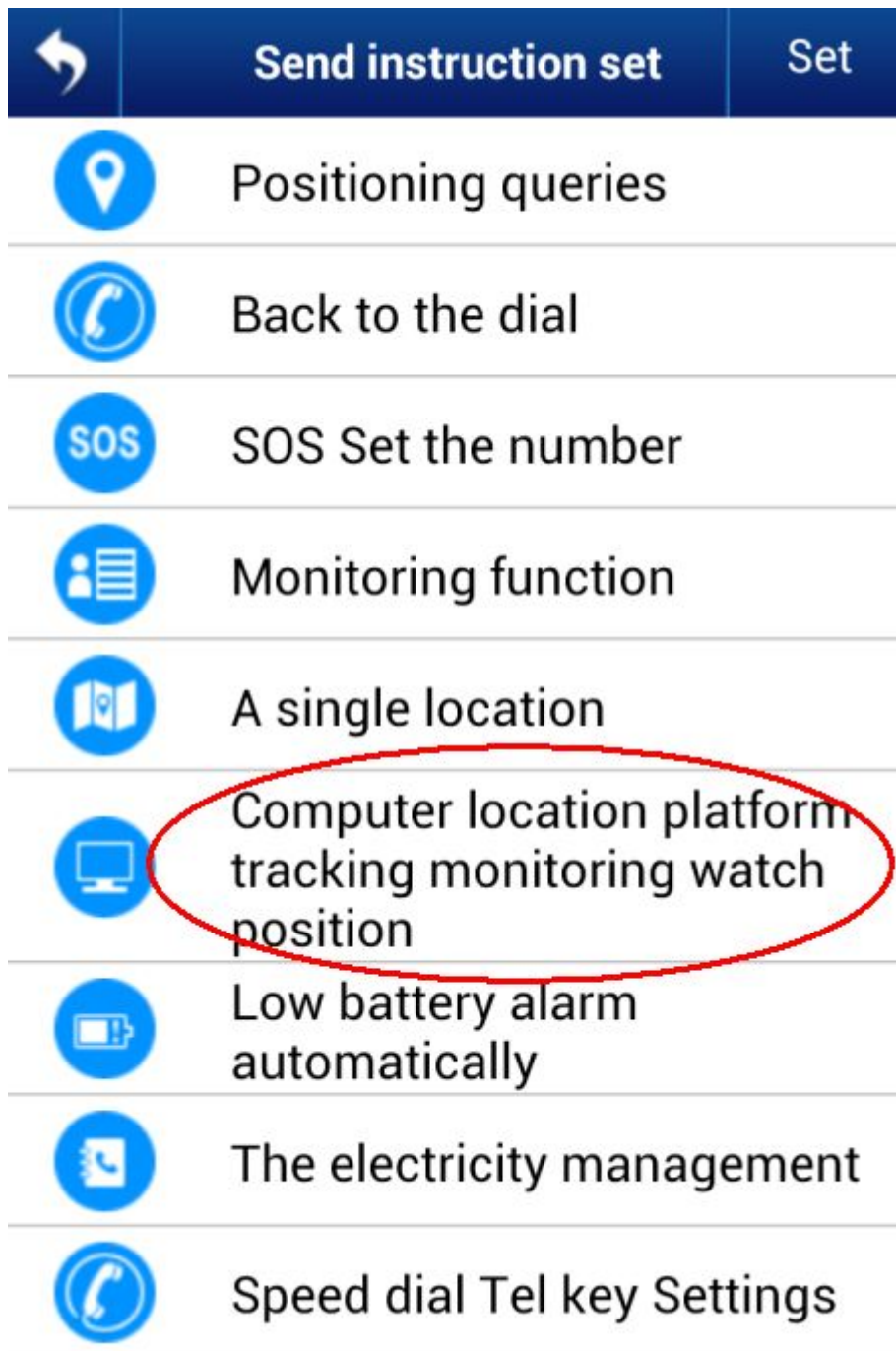

Update directly enter numbers can be, for example: 60 or 0, and then press OK.

track 60seconds per time, 0 means turn off online platform tracking .

To save power, turn off the PC platform if no need this function.

If watch is "power off" and then "power on " ,PC platform tracing is disabled by default.

Open the PC platform computer, platforms tracking URL [www.gps1166.com](http://www.gps1166.com)

Enter the login name: the same as watch's IMEI numbers.

How to know right IMEI number:

1: there is a IMEI sticker on the watch.

2: SOS numbers send SMS to watch: **IMEI** (read 5.12)

Default password : 123456



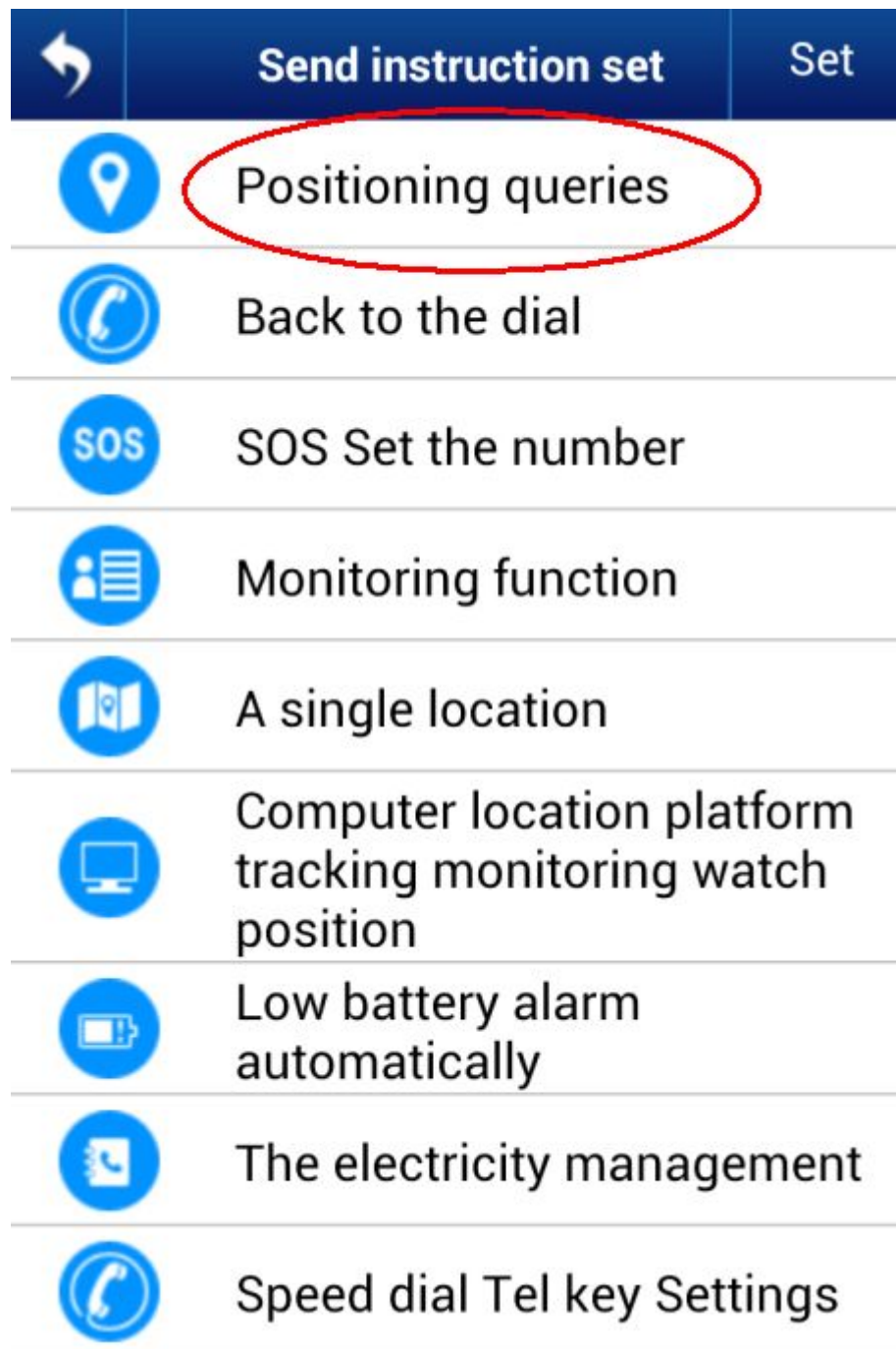







(5.18) Positioning query function (map link, need base on good GPS signals environment)



When watch get GPS signal, will reply a map link to SOS numbers,if no GPS signal will be LBS reply with text message.









(5.19) Call-back



	Send instruction set	Set
	Positioning queries	
	Back to the dial	
	SOS Set the number	
	Monitoring function	
	A single location	
	Computer location platform tracking monitoring watch position	
	Low battery alarm automatically	
	The electricity management	
	Speed dial Tel key Settings	









Watch automatically dials the number currently send SOS message, double-talk and call back after the watch.

**(5.20) Monitoring function**

←	Send instruction set	Set
	Positioning queries	
	Back to the dial	
	SOS Set the number	
	Monitoring function	
	A single location	
	Computer location platform tracking monitoring watch position	
	Low battery alarm automatically	
	The electricity management	
	Speed dial Tel key Settings	









Guardians can use this function to listen to the voice of nearby ward, but if the watch is locked, nothing happens.

**(5.21) Single Location**











←	Send instruction set	Set
	Positioning queries	
	Back to the dial	
	SOS Set the number	
	Monitoring function	
	A single location	
	Computer location platform tracking monitoring watch position	
	Low battery alarm automatically	
	The electricity management	
	Speed dial Tel key Settings	

Positioning watch will send SMS reply location information about current ward's to SOS numbers automatically.

(5.22) Low battery alarm

←	Send instruction set	Set
	Positioning queries	
	Back to the dial	
	SOS Set the number	
	Monitoring function	
	A single location	
	Computer location platform tracking monitoring watch position	
	Low battery alarm automatically	
	The electricity management	
	Speed dial Tel key Settings	

When the watch is low battery, it will reply a SMS: low battery to 1SOS numbers.  
**(5.23) Call Management**

	Send instruction set	Set
	Positioning queries	
	Back to the dial	
	SOS Set the number	
	Monitoring function	
	A single location	
	Computer location platform tracking monitoring watch position	
	Low battery alarm automatically	
	The electricity management	
	Speed dial Tel key Settings	











On:

When get this command, Except Three SOS numbers can call the watch, any other numbers are impossible.

Off:

Allow all phone numbers call the watch.

**(5.25) Advanced Settings**

	Send instruction set	<b>Set</b>
	Positioning queries	
	Back to the dial	
	SOS Set the number	
	Monitoring function	
	A single location	
	Computer location platform tracking monitoring watch position	
	Low battery alarm automatically	
	The electricity management	
	Speed dial Tel key Settings	

Open "Settings"

(5.26) **Change watch's Password**

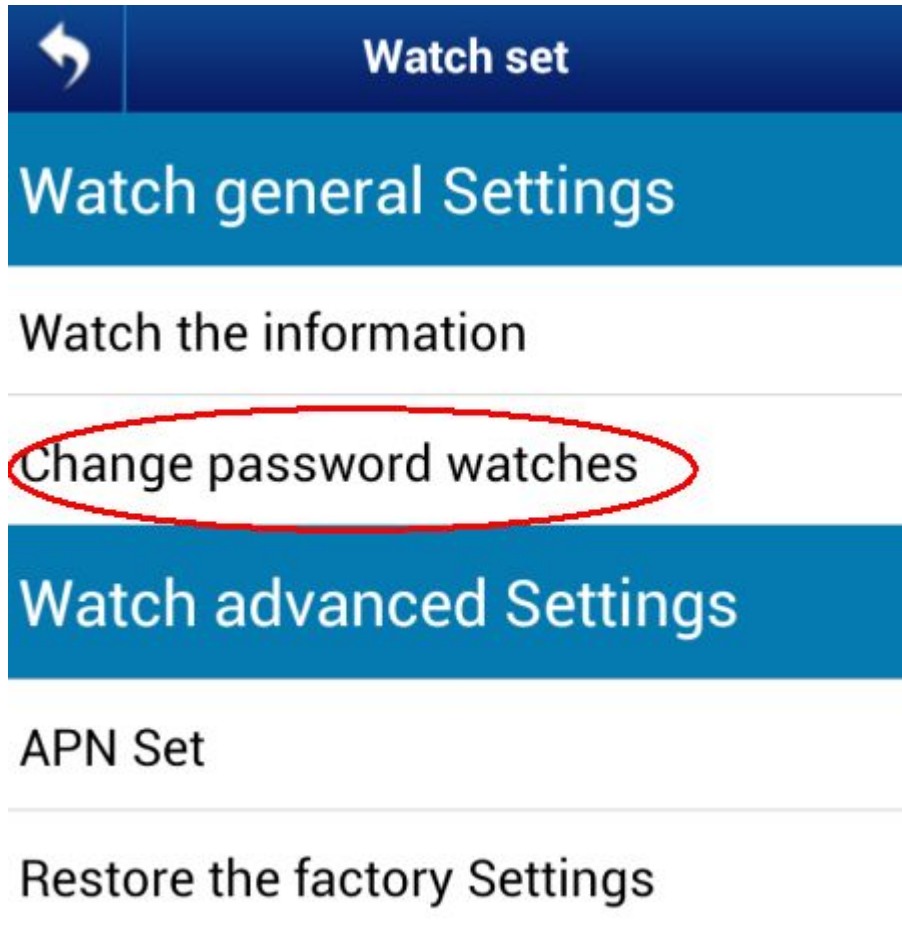

For example:

Click change watch's Password, write down new password: 1234, click ok.

Feedback : set psw ok!

The watch's password have amend to 1234. The default password is :0000,  
Only 1SOS phone NO. can change this password.

## (5.27) **Set APN**

**Set APN is for the watch can send data to the platform by GPRS.**

China usually no need set apn, but many other countries and regions need Set APN.

About APN info the user can ask the telecom provider of the sim card in the watch.



## APN Set

Note: please do not arbitrarily change watch APN Settings, just try to use this feature when watch abnormal network connection.

Note: your current mobile phone number must be number send instructions will only be effective for administrator.

account:

connection:

username:

password:

For example:

On this software, choose APN set, write down the correct APN info.

feedback: set apn ok!

Only 1SOS phone NO. can set and change this APN.



(5.28) Restore factory settings

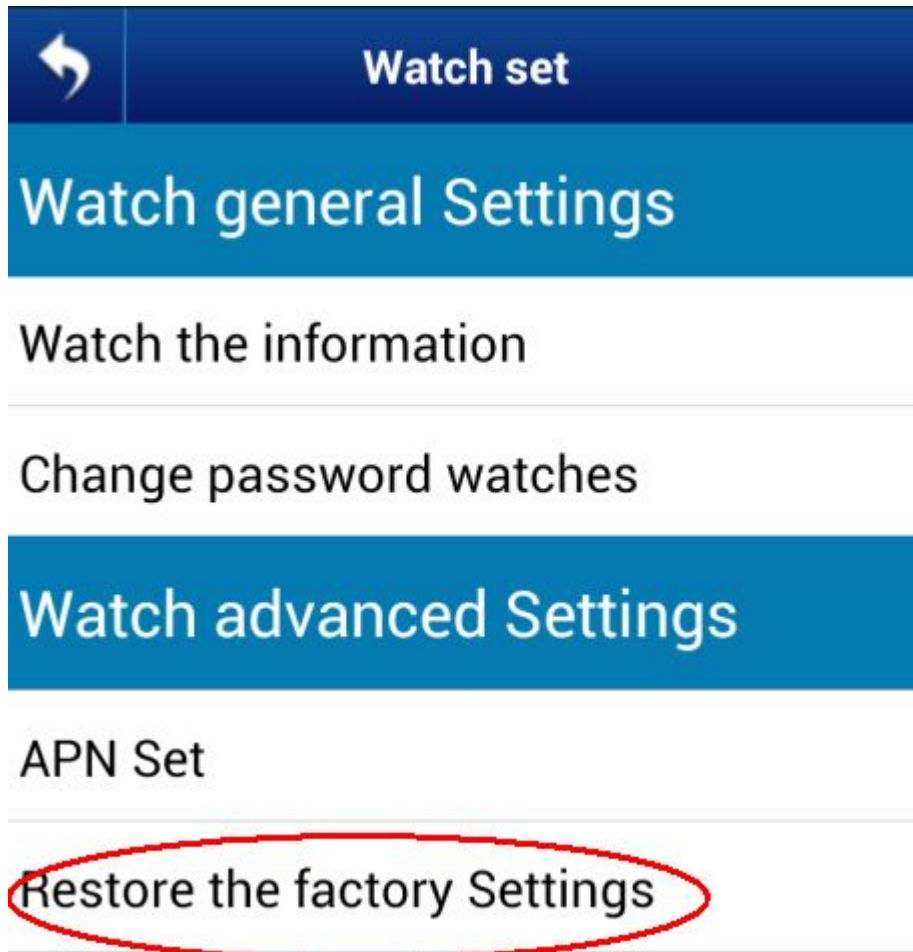

This set will clear watch' s all settings, including user information, and so on.

**If you cannot use this apK software, please use the above message instruction to set the watch.**

## 6. PC-WEB service platform

### 6.1 Login

Login the WEB of the service platform---- [www.gps1166.com](http://www.gps1166.com) with a user name, password, click "GO" to enter the platform interface.

The user name is the IMEI code of the watch

- 1: watch IMEI number is attached to the watch behind with 15 digitals, Method
  - 2: Send SMS "IMEI" to the watch. The watch will reply SMS about it's IMEI.
- Default password: 123456, you can change it on website.

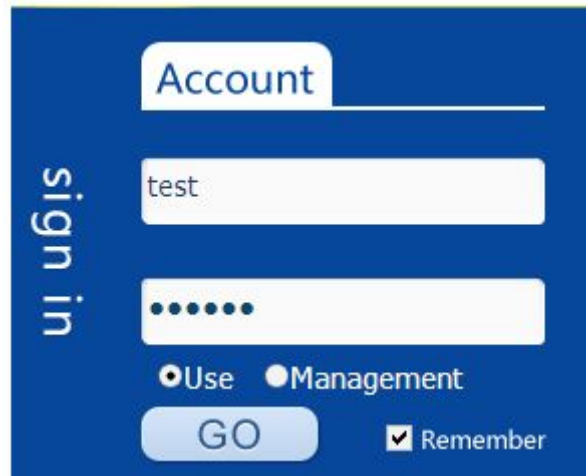

## 6.2 Current location(need to set the SOS number and platform tracking function)

Search the tracker name in the left equipment list, it will list the target updating position.



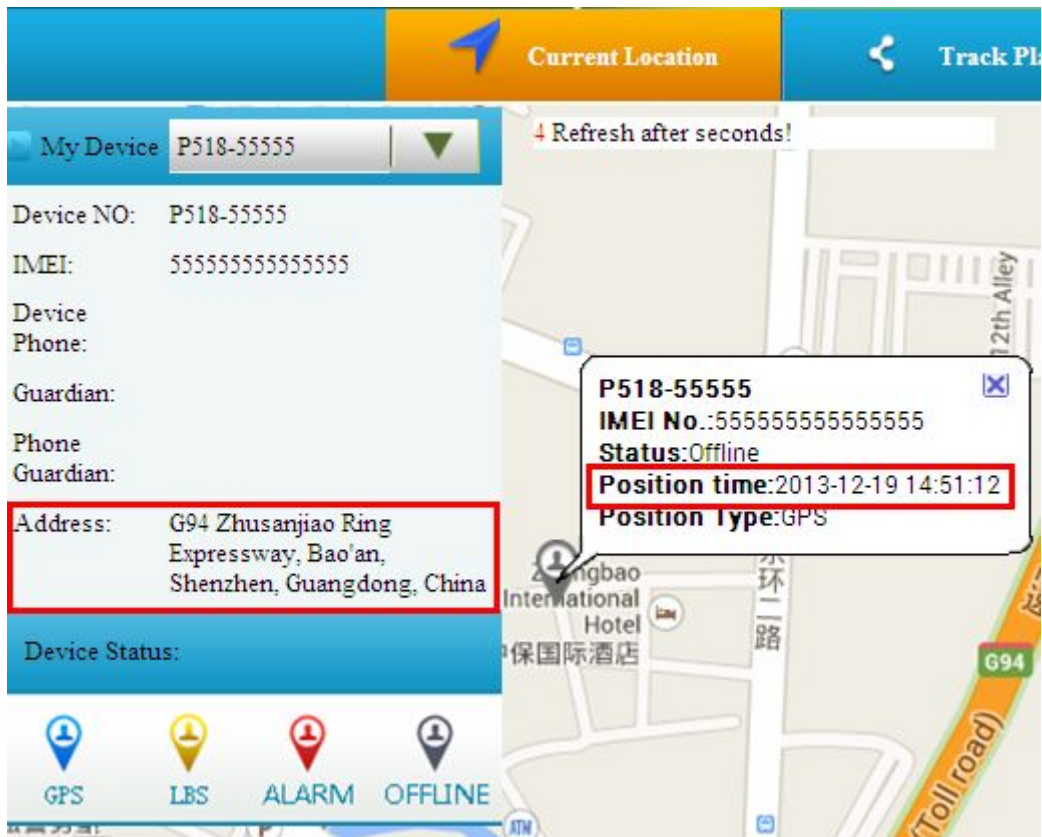

Tracking online

### 6.3 Historical track playback

Click the icon to view the detailed position and tracking time

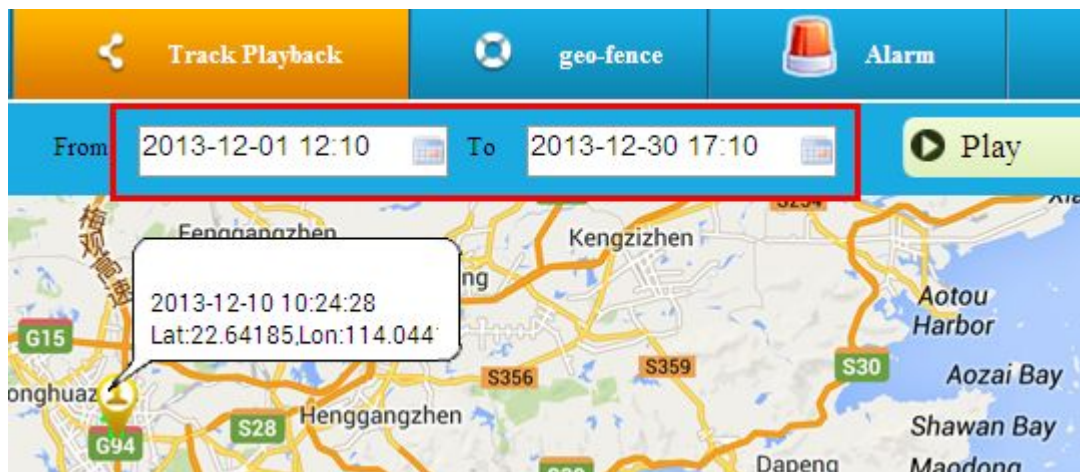

Track Play back

## 6.4. GEO-FENCE

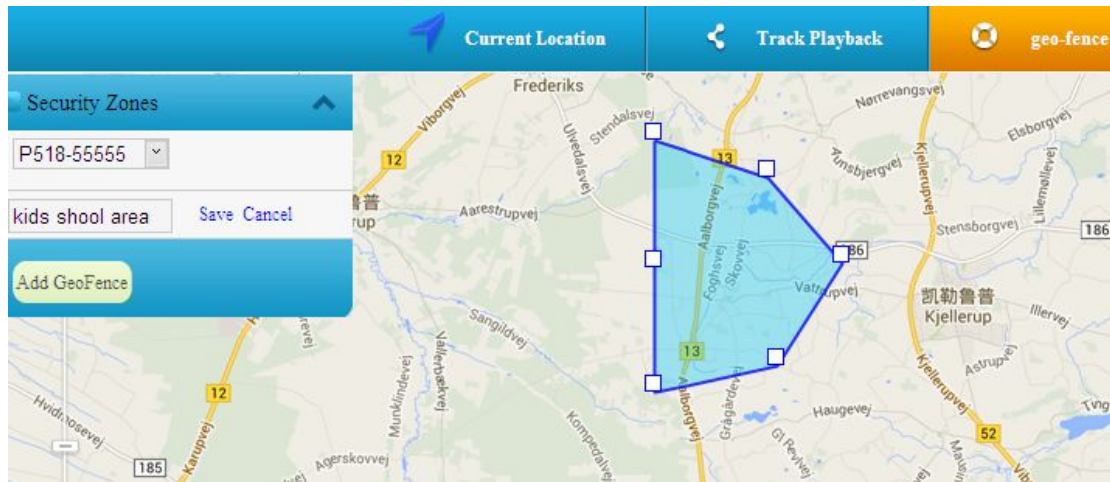

Click the "new electronic fence" button on the top left corner. There will be a circular fence area display as the figure, the size range of electronic fence can be selected by dragging edge of any shape region, platform will alarm when watch is beyond the fence area.

## 6.5. Platform alarms

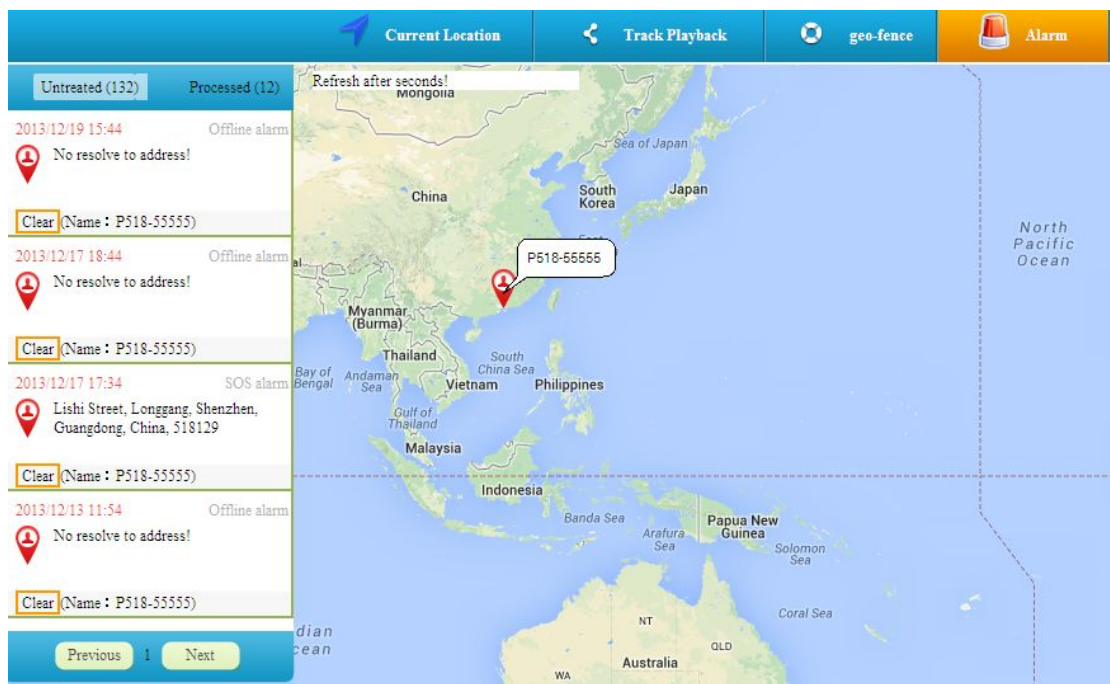

Click "message" menu on the top right corner of map to check all alarms.

## 7. Phone tracking platform

(7.1) Select Android smart phone “Unknown sources”

<  Security

## Set up SIM card lock

### Passwords

**Make passwords visible**



### Device administration

## Device administrators

View or disable device administrators.

## Unknown sources

Allow installation of apps from sources other than the Play Store



### Credential storage

## Trusted credentials

Display trusted CA certificates.

## Install from device storage

Install certificates from storage.

## Clear credentials

Remove all certificates.

In the android smart phone—setting—security— “Unknown sources” , shown as the picture

(7.2) Software download address : [www.gps1166.com](http://www.gps1166.com) into the website and click the watch mobile terminal to download and install, or scan the QR code to download to the phone

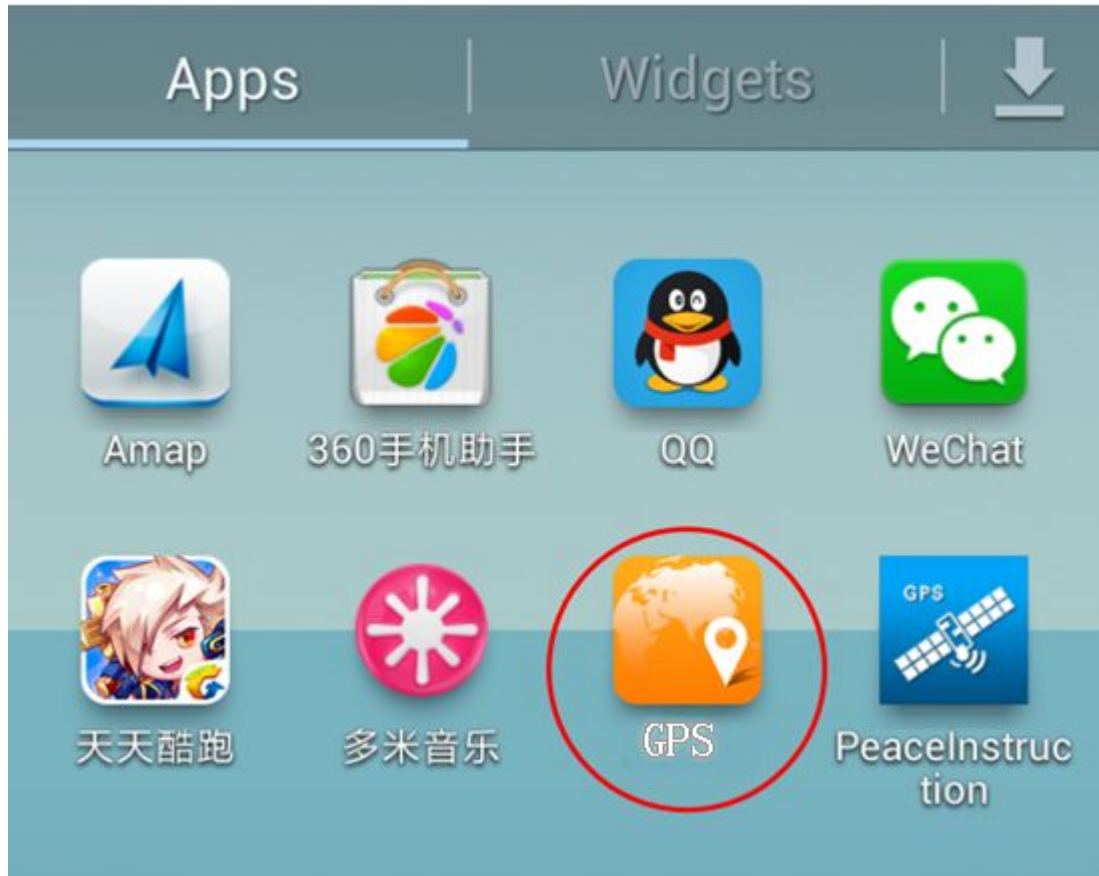

(7.3) Open and login into the platform in smart phone

The image shows a login interface on a blue background. At the top, there are two input fields: the first is labeled '账号:' (Account) and contains the text 'test'; the second is labeled '密码:' (Password) and contains six dots. Below these fields is a checkbox labeled 'Remember username and password'. At the bottom of the form is a large blue button with the text 'Login in'. At the very bottom of the page, there are two icons: an orange person icon on the left and a white smartphone icon on the right.

Insert the Account and password to login

The user name is the IMEI code of the watch (Method 1: watch IMEI number is attached to the watch behind with 15 digits, Method 2: Send SMS "IMEI" to the watch. The watch will reply SMS about its IMEI.) Default password: 123456, you can change it on website.

#### **(7.4) Tracking list**

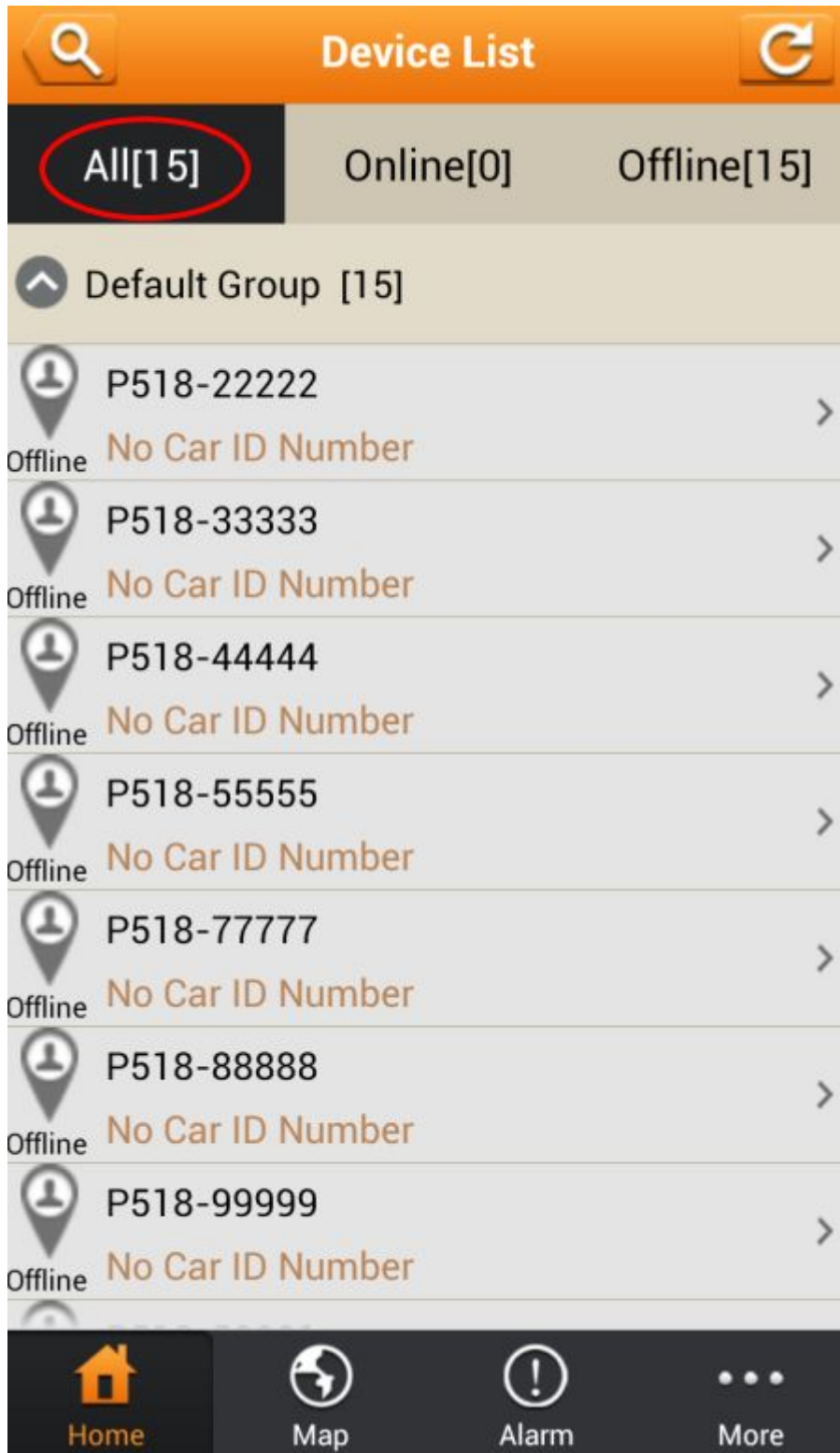

Check the watch status “all ” “online” “offline”

(7.5) Real –time tracking (Set SOS number and platform tracking function)





(7.6) Playback list

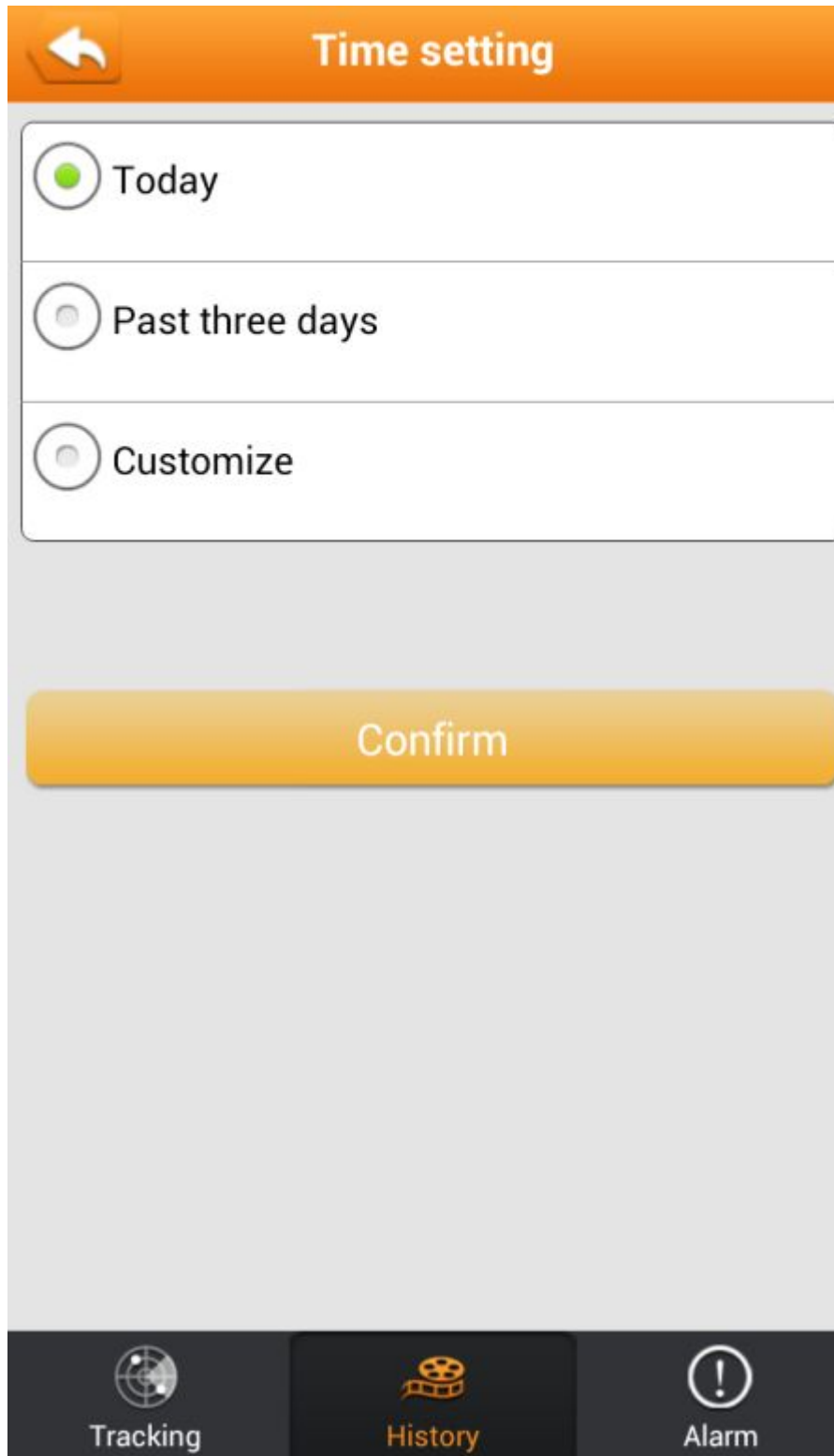

(7.7) Alarm message

 **Alarm List** 

Device name : P518-55555	Device type : P518
<b>Alarm type : Offline alarm</b>	
Positioning time : 2013/12/19 14:51	
Alarm time : 2013/12/19 15:44	
Device name : P518-55555	Device type : P518
<b>Alarm type : Offline alarm</b>	
Positioning time : 2013/12/17 17:46	
Alarm time : 2013/12/17 18:44	
Device name : P518-55555	Device type : P518
<b>Alarm type : SOS alarm</b>	
Positioning time : 2013/12/17 17:34	
Alarm time : 2013/12/17 17:34	
Device name : P518-55555	Device type : P518
<b>Alarm type : Offline alarm</b>	
Positioning time : 2013/12/13 11:02	
Alarm time : 2013/12/13 11:54	
Device name : P518-55555	Device type : P518
<b>Alarm type : Offline alarm</b>	
Positioning time : 2013/12/13 08:21	
Alarm time : 2013/12/13 09:14	
Device name : P518-55555	Device type : P518
<b>Alarm type : Offline alarm</b>	
Positioning time : 2013/12/10 14:54	
Alarm time : 2013/12/10 15:47	

 Tracking  History  Alarm

## 8. FAQ

Question	Solution
Tracking Watch shows no services after Starting-up	Please check the SIM card if inserted.
Watch cannot calling	Make sure the host SIM card whether open caller ID display
The watch cannot send the location information to the service platform	Please check the account of SIM card
Cannot get online information of Tracking Watch on service platform	Please check the watch operating mode
Send SMS command but without confirmation by SMS	Confirm the SMS Editorial content format is correct, and if the sender is SOS number
Single time location just with latitude and longitude coordinates, no more details description	Make sure if the GPRS transmission failure due to SIM card arrears



QR code for smartphone tracking platform, scan and download



GPS watch command software, scan and download