

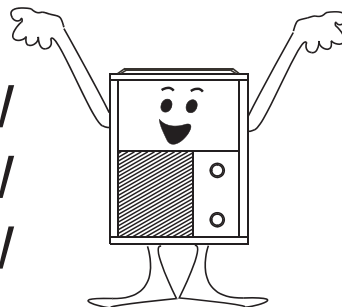

AS-H40Y - 12kW

AS-H50Y - 15kW

AS-H60Y - 18kW



ALTO HEAT PUMP INSTALLATION MANUAL

F1-F7

CUSTOMER NAME.....

POOL DEALER.....

DATE INSTALLED.....

SERIAL NO.....

MODEL.....

SAFETY INSTRUCTIONS

Please read this safety instruction carefully before operation.

Heat pump must remain upright at all times.

Do not place objects on to heat pump

Do not disconnect/connect power supply during operation as this may cause serious damage.

Do not insert objects into the air inlet/air outlet grilles.

All electrical connections should be made by a qualified electrician. Do not connect heater to an electrical supply using a 13 amp plug.

When cleaning the heater unit switch off power supply.

Do not operate electrical switches with wet hands.

Repair or relocation should be carried out by a specialist contractor.

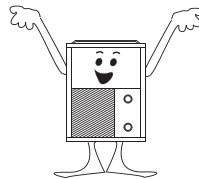

INDEX

Page 4	Installation and Siting
Page 5	Plumbing
Page 9	Electrical Connection & Circuit Diagram
Page 10	Control Panel Functions F1-F7
Page 13	Refrigerant/Flow Meter
Page 14	Control Panel Error Display E1-E4
Page 15	Auto Restart and Defrosting Function
Page 15	FAQ
Page 16	Water Chemistry / Winterising & Start-up Procedure
Page 17	Warranty Policy
Page 18	Heat pump Service & Breakdown
Page 19	Alto Heat Pump Specification

HEAT PUMP- AS-H40Y 12kW

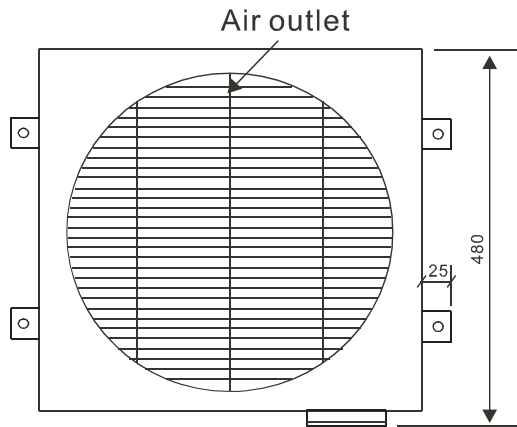
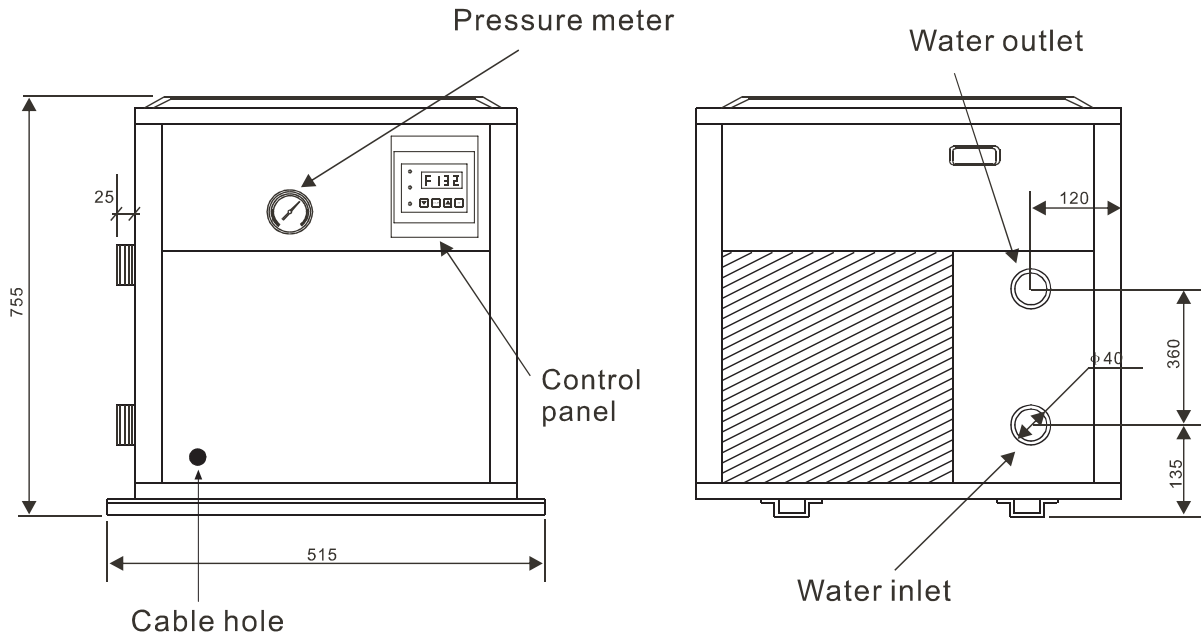

● Control panel

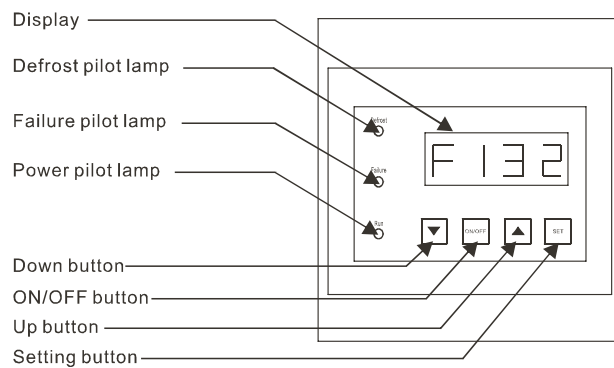

HEAT PUMP- AS-H50Y (15kW) & AS-H60 (18kW)

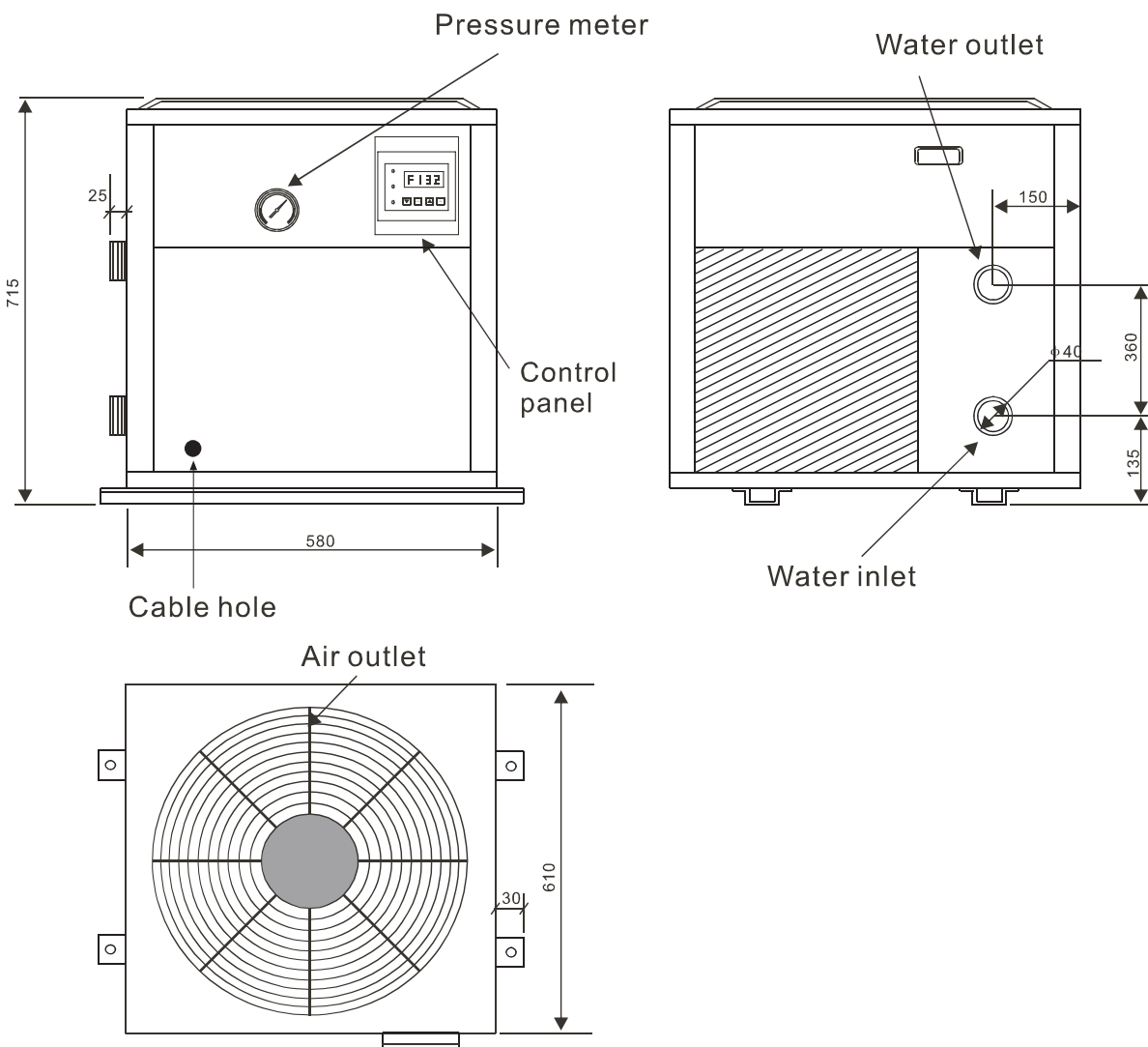

● Control panel

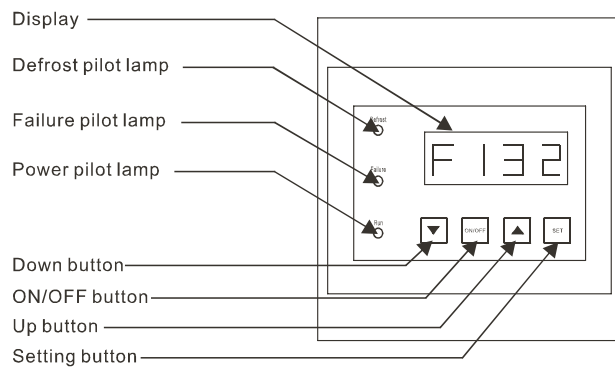

INSTALLATION AND SITING



Prior to installing your heat pump:-

All heat pumps are factory assembled and tested prior to delivery. Please check for any external damage especially to the evaporator fins, please diagram below. Do not be concerned about minor damage or indentations to the fins (especially where the fan unit is mounted) as it will not affect performance. If severe damage has occurred please contact your supplier immediately and do not attempt to install heater unit.

IF HEAT PUMP HAS BEEN PLACED ON IT'S SIDE IN TRANSIT THEN HEATER MUST BE LEFT IN AN UPRIGHT POSITION FOR A MINIMUM PERIOD OF 24HRS PRIOR TO OPERATION (failing the above may cause damage to the heat pump and invalidate your warranty).

Siting

As the air flow is discharged from the top of the heat pump all units are designed to be installed outside. If unit is to be installed inside the filtration/plant room adequate ducting and ventilation must be installed. Please contact your dealer for advice.

Heater unit **must be installed using plastic anti vibration pads (provided)** on a solid LEVEL foundation i.e. concrete base or paving slabs. Using the plastic pads reduces vibration noise and prevents corrosion to the base of the heat pump. **DO NOT PLACE ONTO SOFT GROUND I.E. GRASS.** Please Note: the heat pump collects condensation from the evaporator fins and will continually discharge small amounts of condensate (water) out of the base of the unit via a drain tube. Therefore, it is recommended that the drain tube is directed to an area with adequate drainage.

Make sure that heat pump remains free of any obstructions, foliage etc. A minimum clearance is required around heater unit, please see drawing below. Make sure that easy access can be gained to service panel and plumbing connections. Do not obstruct access panel with plumbing pipework.

Multiple connections- install heat pumps 500mm apart and independently protect each unit by 20amp MCB - see also page 8, Drw.4 for plumbing detail. Make sure that heat pump grilles are not blocked by loose debris such as leaves, grass cuttings, garden furniture etc.

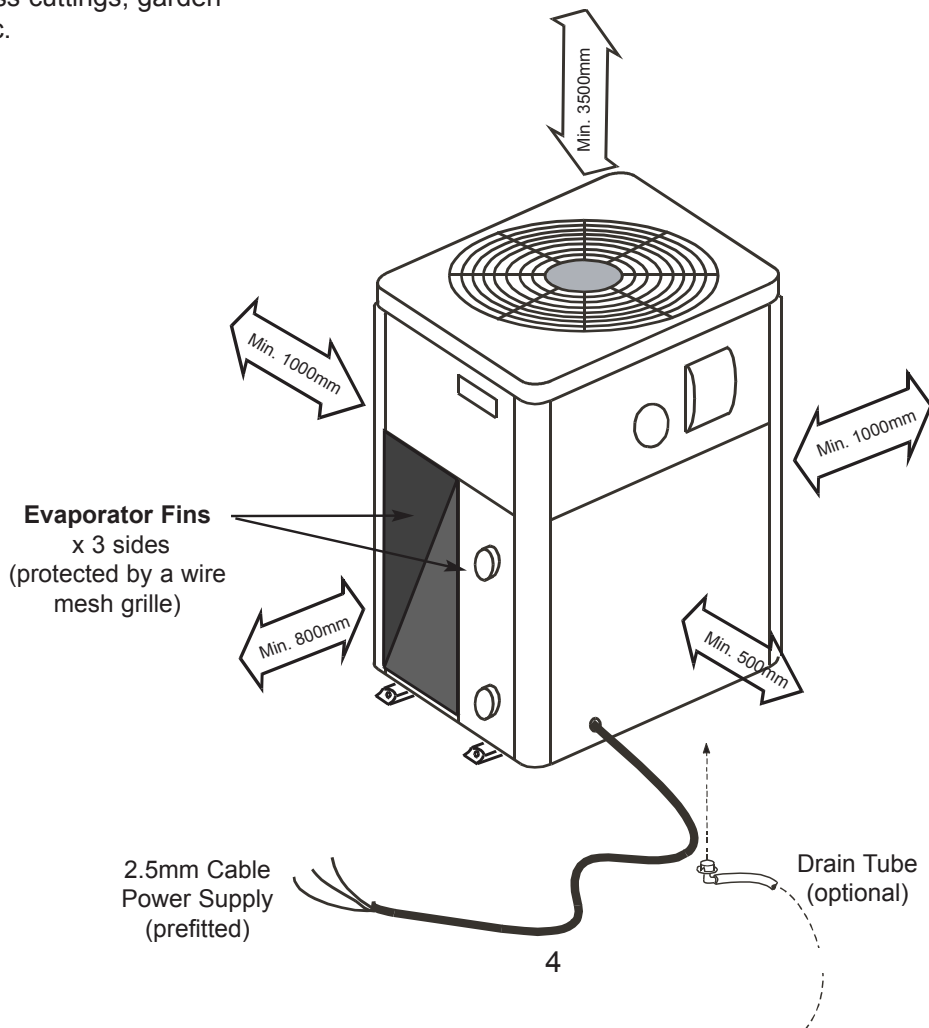

PLUMBING

Alto heat pumps are supplied with 1.5" BSP parallel threads, male. We strongly recommend a 1.5" female socket union is applied to inlet/outlets for future draining and servicing of the appliance.

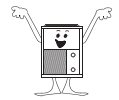
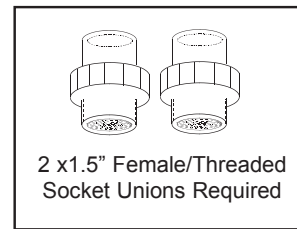

Alto heat pumps must be installed in the return line after the filter. If an existing heater or back-up heater has been installed then the heat pump should be installed between the filter and the other heater. If solar heating has been installed, the heat pump should be installed after the solar heating system. See Drw.2 page7.

If the heat pump is to be installed at a lower level than the pool then isolation valves or non-return valves should be installed.

Do not route any plumbing lines across heater inlet panels. All plumbing should be adequately supported.

Once all plumbing connections have been completed the filtration should be turned on and the systems tested for leaks. A refrigerant/flow meter is located next to the control panel. Alto heat pumps will generally take the full flow of the filtration pump. In some instances if there is too much flow (see page 12 re refrigerant/ flow meter) a by-pass may be required. If there is insufficient flow an auxiliary booster pump may be required. Please contact your dealer for advice.

Important - (applicable for stainless steel/copper heat exchangers) Standard unit. If your pool has an automatic chemical dosing appliance the heat pump should be installed prior to the dosing system. See applicable drawings (1-4) on pages 7-8.

FLOW SWITCH (Optional)

Alto heat pumps have the option of installing a flow switch. A flow switch will deactivate the heater if there is a loss of water flow i.e. in the event that the circulation pump deprimed (no flow) the heater will switch off.

We recommend that the heat pump should be interlock wired with the circulation pump i.e. heat pump only functions when pool circulation pump is running. A flow switch (provided) can also be installed **as an extra precaution** in the event that there is a loss of water flow (i.e. circulation pump deprimed).

It is our recommendation that the flow switch is installed for added protection on a pool installation that is **below ground**. If the heater is to be installed on an above ground pool, the circulation pump is normally under flooded suction therefore, heater and filtration pump could be wired together.

In the event that there is no flow 'E3' will be displayed on the control panel and heater will stop functioning.

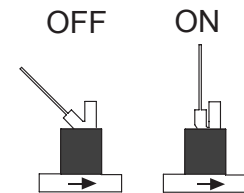

ELECTRICIAN NOTE - PLEASE CHECK CONTINUITY OF FLOW SWITCH BEFORE INSTALLING.

PLEASE ALSO SEE PAGE 15 - FILTRATION & FAQ

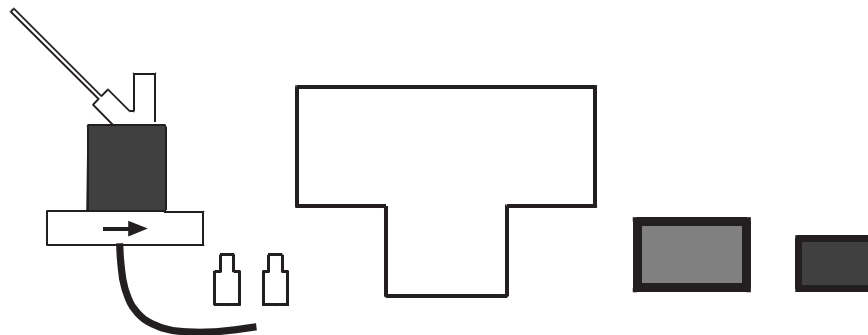

- 1 X FLOW SWITCH
- 1 X CRIMP -ON CONNECTIONS
- 1 X 1.5"- 0.75" PLN RED. BUSH
- 1 X 0.75" PLAIN - 0.5" FEMALE THR. RED. BUSH

FLOW SWITCH INSTALLATION GUIDE (optional)

1. Insert reducing bushes (provided) into 1.5" Tee using suitable adhesive.
2. Connect 1.5" Tee to socket union adjacent to Inlet on heat pump. Tee can be installed horizontally or vertically!
3. Using PTFE tape insert flow switch into Tee **making sure that the arrow on the flow switch points towards the heater.**
4. Turn off electrical supply to heat pump. Run the wire lead from the flow switch and make connection to No. 1 & 2 on the electric terminal block - see diagram below (wire extension may be required). Note:- you will have to **remove a pre-fitted loop** that is already connected to No.1 & 2 see dia. below.

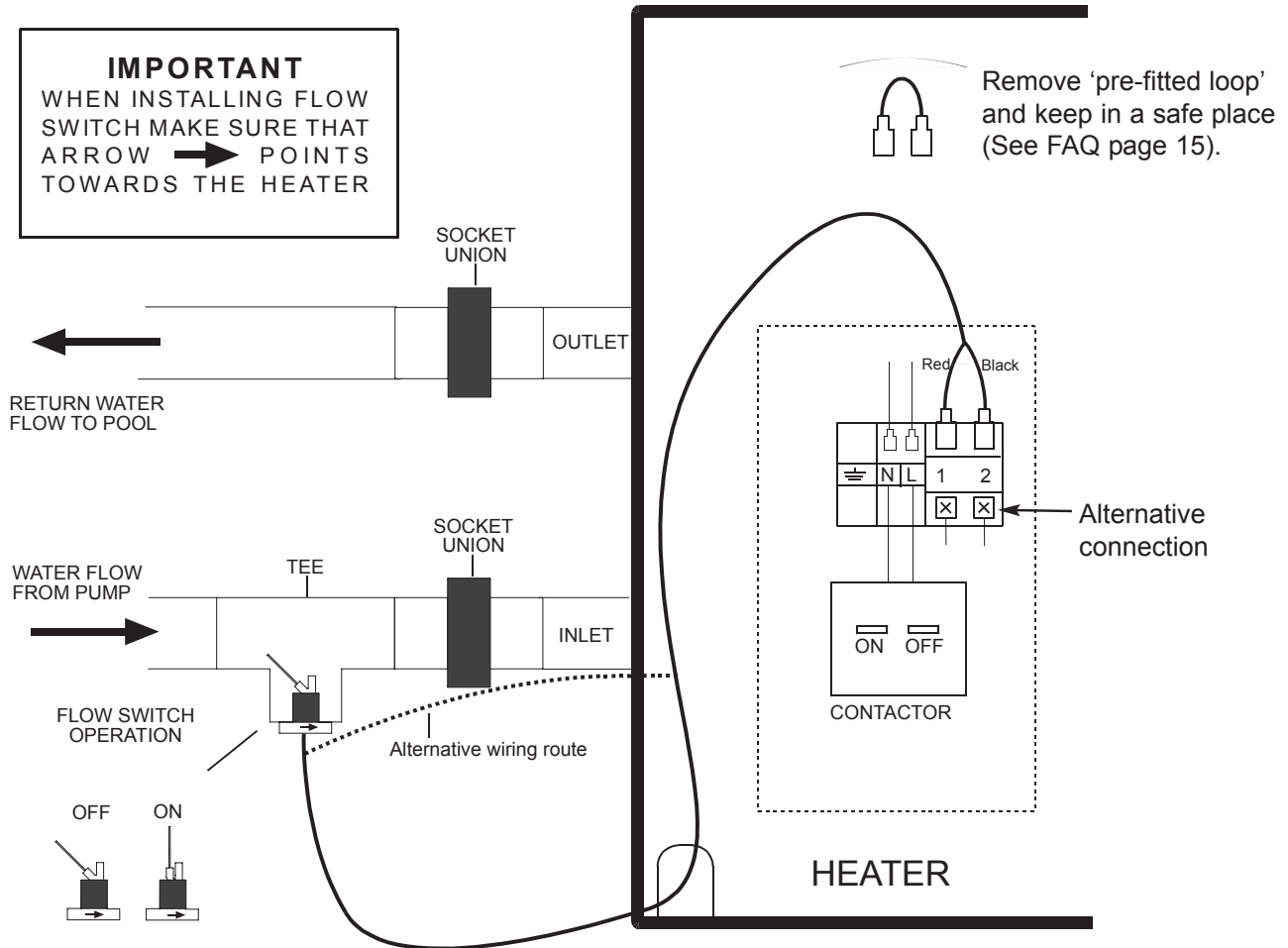

ANTI VIBRATION PADS AND DRAIN TUBE

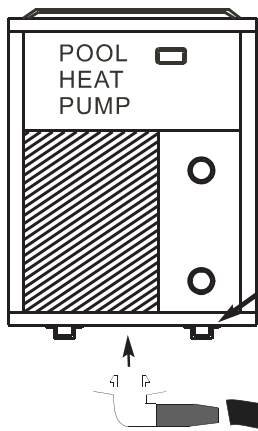

The following parts should be installed prior to connecting pipework. **Drain tube will not fit if vibration pads are not installed on the 12kW model!**

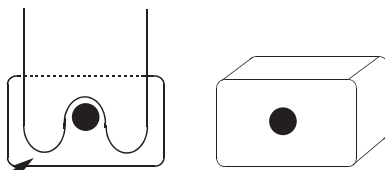

X 4 ANTI VIBRATION PADS (PLASTIC)
Install on underside of heater. It is recommended that Stainless Steel screws & plugs are used when securing to floor. **Installing anti vibration feet will also help prevent corrosion to the base of the heat pump.**

1 X DRAIN VALVE (RUBBER) 1 X 2m FLEXIBLE DRAINAGE TUBE
Insert drain valve into drainage hole located on underside of heater and push fit the drainage tube onto valve (**Tip-you will find it much easier to insert drain valve if it is immersed in hot water or sprayed with silicone spray prior to fitting**). Drain valve installation is optional.

PLUMBING LAYOUT

Drw.1 Recommended plumbing layout for a standard heat pump installation.

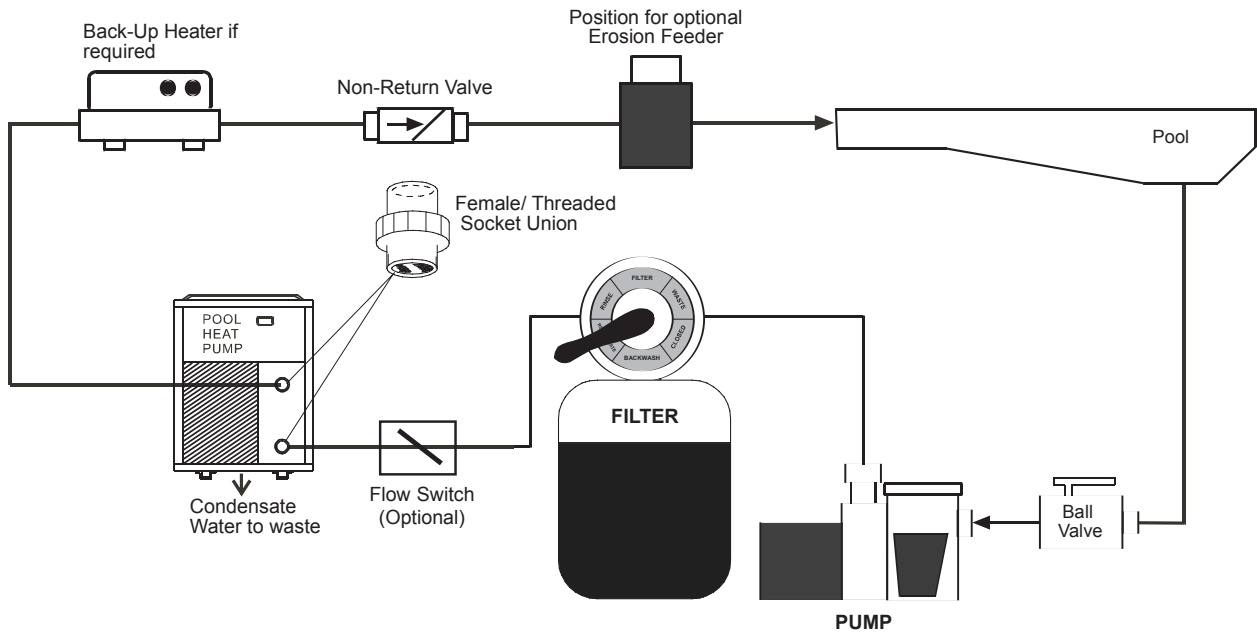

Drw.2 Recommended plumbing layout when incorporating Solar Heating. *If an increased flow rate is required instal a booster pump as per drw.4 below.*

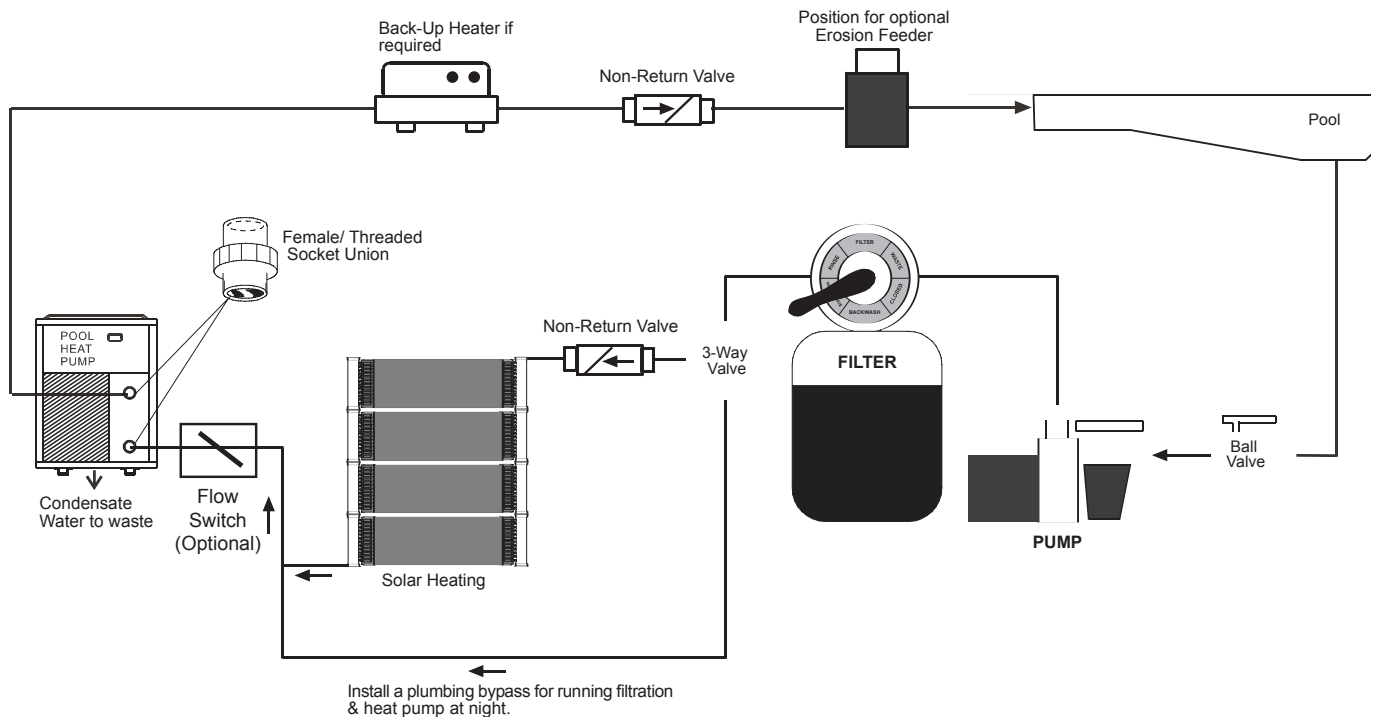

Drw.3 Recommended plumbing layout when incorporating Solar Heating & Booster Pump

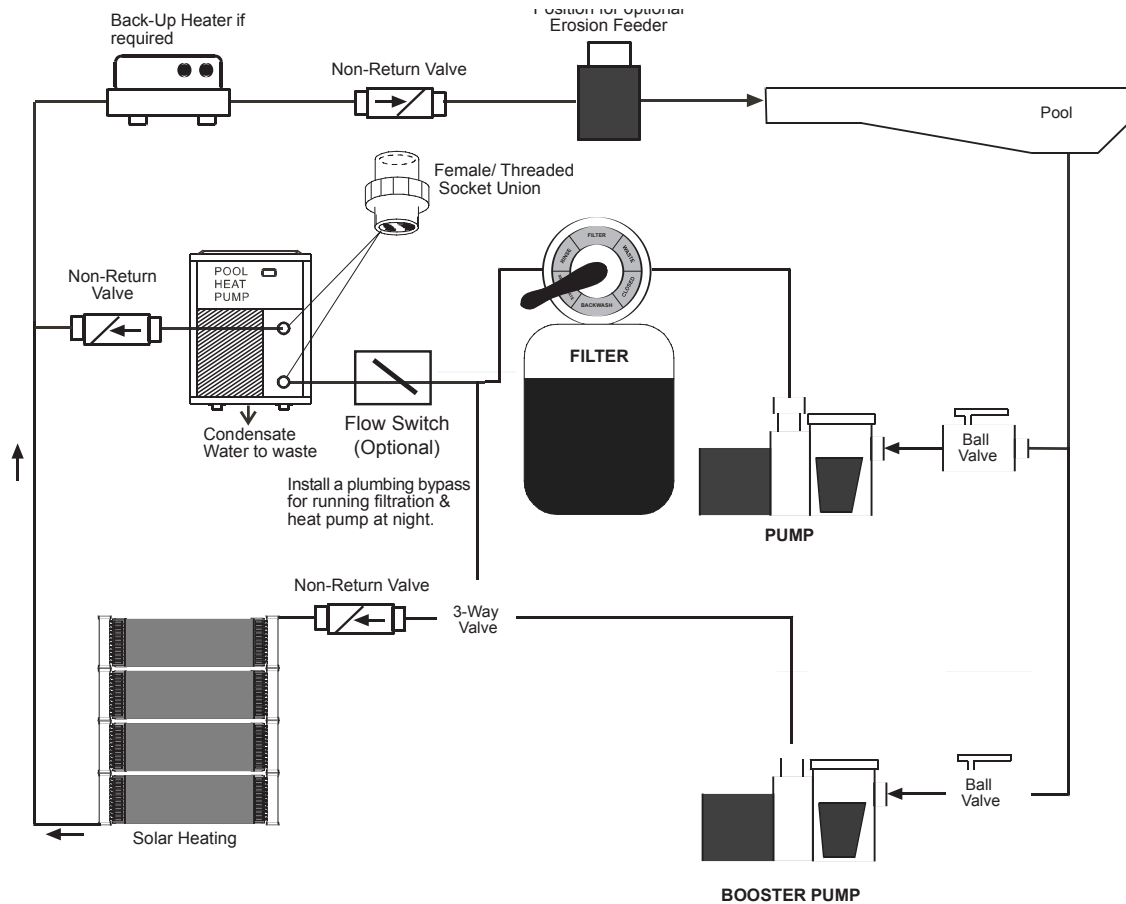

Drw.4 Recommended plumbing layout when incorporating two heat pump units. *IMPORTANT* Minimum flow rate required to use this system is 3000 Litres / 660 Gallons (imperial) per hour.

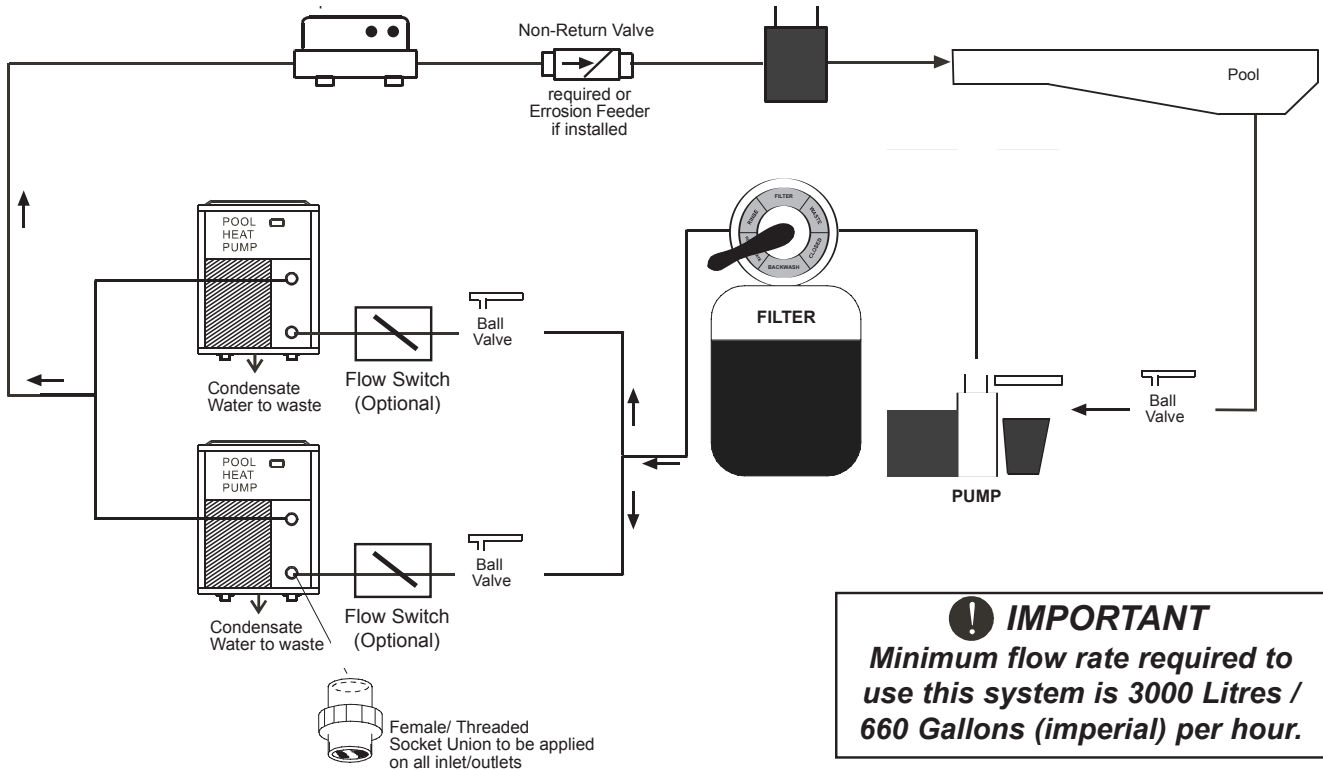

ELECTRICAL CONNECTION & CIRCUIT DIAGRAM



IMPORTANT. It is recommended that all electrical supplies and connections are carried out **by a qualified electrician**, in accordance with I.E.E. standards, latest issue, or local codes of practice as applicable.

Also recommended is a protected supply to incorporate fuses or motor type circuit breaker (**Type C**) to specified rating (see Data Sheet page 19).

An earth leakage trip (R.C.D) of the current operating type (30mA) is recommended to be fitted to all pool electric's.

Minimum/Maximum Voltage requirements.:

Single phase machines 50Hz 207v 253v

Three phase machines 50Hz 360v 440v

Cycle Frequency 50Hz 47.5Hz 52.5Hz

N.B. This voltage must be available at the heat pump whilst running.

A 40 AMP / 2 Pole Contactor is required to interlock heat pump and circulation pump i.e. heat pump only functions when pool circulation pump is running. A flow switch (provided & optional - see page 5) can also be installed as an extra precaution in the event that there is a loss of water flow (i.e. circulation pump deprimes).

NOTE - PLEASE CHECK CONTINUITY OF FLOW SWITCH BEFORE INSTALLING.

AS-H40Y (12KW) AS-H50Y (15KW) AS-H60Y (18KW) SINGLE PHASE (1-N 50HZ)

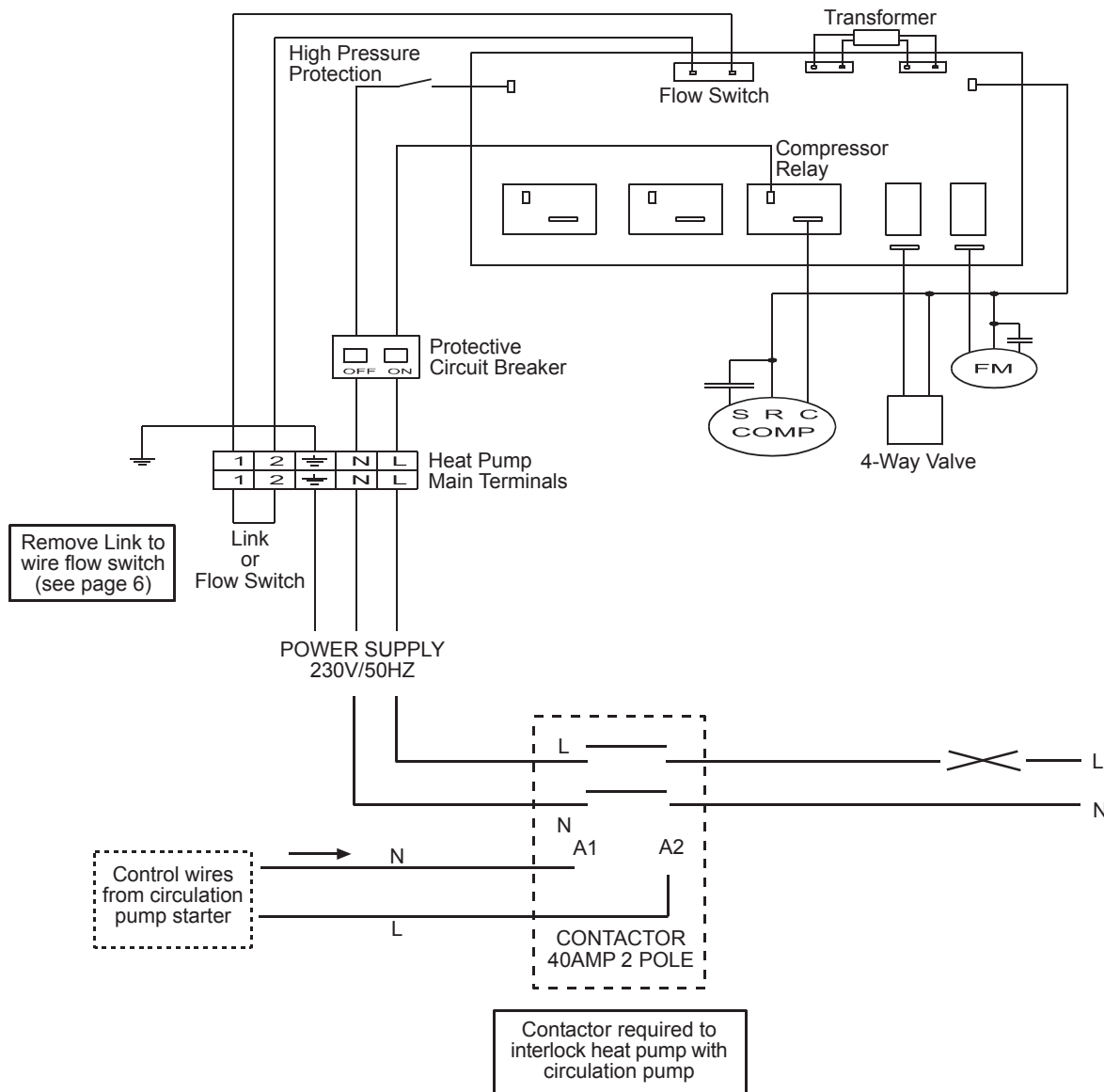

CONTROL PANEL FUNCTIONS

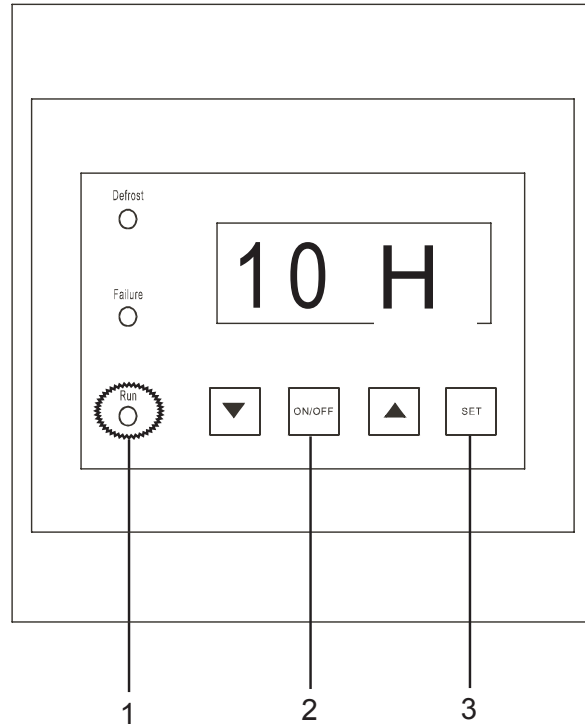

1. When electric supply is connected the 'Run' power light will be on and the display panel will display the current water temperature. ie. 10 H = 10°C.
2. On/OFF button to turn heater on and off.
3. The 'set' button is used to set the F1-6 functions ie. water temperature, defrosting cycle and defrosting time etc. see pages 11-12

**PLEASE READ THE CONTROL
FUNCTIONS CAREFULLY AND MAKE THE
NECESSARY ADJUSTMENTS BEFORE
USING YOUR HEATER**

CONTROL PANEL FUNCTIONS 1-3

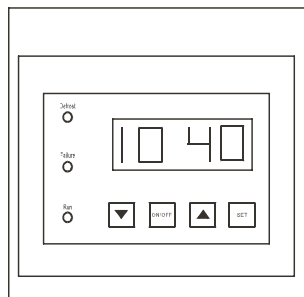

When the ON/OFF buttons is pressed for the first time, the display panel will display the current water temperature and the desired pool temperature.

eg. the display may read 10 40 ----- 10 is the current water temperature 10°C and 40 is the desired water temperature 40°C.

ADJUSTING THE POOL WATER TEMPERATURE

Using the up and down buttons, you can set the swimming pool water to the desired temperature between +15°C up to + 65°C.

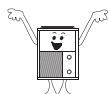

NOTE. WHEN PROCESSING FUNCTIONS F1-F5 IF NO ADJUSTMENTS ARE MADE FOR 5 SECONDS THE DISPLAY WILL REVERT BACK TO THE CURRENT & DESIRED WATER TEMPERATURE AS ABOVE

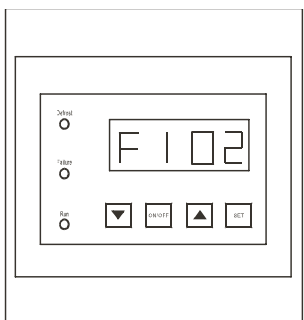

When the SET button is used for the first time, the display panel will display **F1-this is to set the temperature differential**. The recommended setting is 2°C. To adjust setting **YOU MUST PRESS THE ON/OFF BUTTON FIRST**. Then use the UP and DOWN button to set the differential temperature range between 0 °C ~ 5°. Press on/off button again to take you back to the normal display. The unit will now stop working when the swimming pool water temperature reaches the setting temperature. The unit will automatically restart when the swimming pool water temperature drops below the setting temperature.

Eg. If current pool water temperature is 20°C, F1 has been set to 02 (heating mode) when the temperature reaches 20°C the heater will stop and restart when the water temperature is below 18°C.

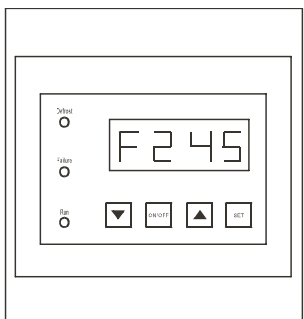

When the SET button is pressed twice, the display panel will display **F2- the defrosting cycle**. The recommended setting is 30 minutes. To adjust setting **YOU MUST PRESS THE ON/OFF BUTTON FIRST**. Then use the UP and DOWN buttons to adjust defrosting period between 30 minutes up to 99 minutes. Press on/off button again to take you back to the normal display. The unit will now start to defrost after the setting period when the defrosting sensor reaches the frosting condition.

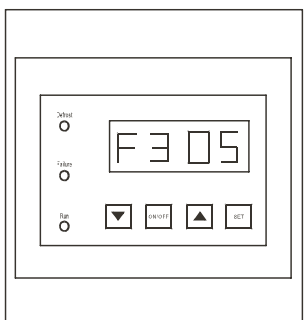

When the SET button is pressed for the third time, the display panel will display **F3 - the defrosting time**. The recommended setting is 5 minutes. To adjust setting **YOU MUST PRESS THE ON/OFF BUTTON FIRST**. Use the UP and DOWN buttons to adjust defrosting time between 3 to 15 minutes. Press on/off button again to take you back to the normal display.

CONTROL PANEL FUNCTIONS 4-7

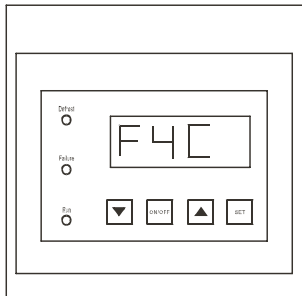
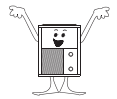

When the SET button is pressed for the fourth time, the display panel will display:-

F4 : Operation Mode.

F4C : Cooling Mode.

F4H : Heating Mode

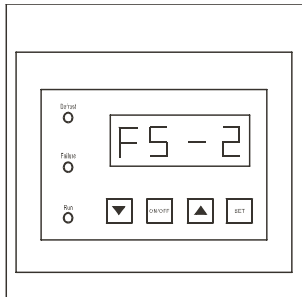

When the SET button is pressed for the fifth time, the display panel will display:-

F5 : The defrosting temperature of the evaporator pipe. The recommended temperature setting for the UK should be set to 0°C. To adjust setting **YOU MUST PRESS THE ON/OFF BUTTON FIRST**. The temperature can be adjusted using the UP and DOWN buttons between -10°C and 0°C Press on/off button again to take you back to the normal display.

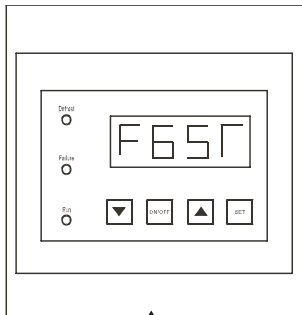

When the SET button is pressed for the sixth time, the display panel will display:-

F6 : EC (Economy) OR ST (Standard) This function is designed for saving energy.

EC: Heat pump will stop working at an ambient temperature of 5°C and will automatically restart when the ambient temperature rises above 10°C

Example. When the heat pump is set in Economy mode, the unit will stop working during the night (when temperature drops below 5°C) and will restart automatically when the temperature rises throughout the day.

ST: (may be shown as **57**) The heat pump will work continuously until the desired temperatures are reached.

To adjust setting **YOU MUST PRESS THE ON/OFF BUTTON FIRST**.



F7 IS ONLY DISPLAYED IF AN ELECTRIC BACK-UP HEATER HAS BEEN INSTALLED

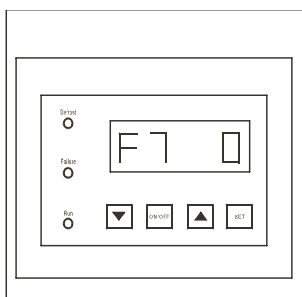

When the SET button is pressed for the seventh time, the display panel will display:- This function is used only in conjunction with a back-up electrical heater.

F7 : ON/OFF Function. 0= turns off heater. 1= turns on electrical heater.

POOL WATER AND GAS REFRIGERANT FLOW METER

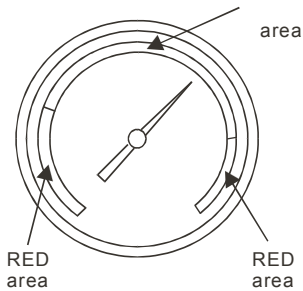
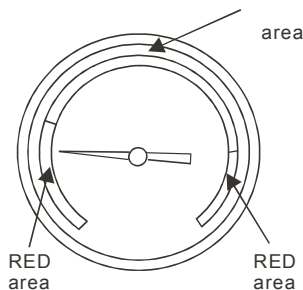

diagram 1

After the water heater has been running for more than 24 hrs, it should be running at full capacity. The PSI reading should be in the region 150 -200. If you want to make the heat pump run more efficiently the water flow should be adjusted by checking the pressure meter display.

If the meter index is in the green area, the water heater is running in the most efficient way and **you do not need to adjust anything**.

If the meter reading is in the red area but you have good water flow from the circulation pump, it may be as a result of low refrigerant gas (see below).



A

diagram 2

In the event that the pressure reading is in the red area 'A' (dia.2) it means there may be insufficient water flow. Prior to any adjustments make sure your filter is clean by using the 'backwashing and rinse procedure (refer to your pool hand book for guidance). Check there are no obstructions in the suction lines i.e. Main Drain or Skimmer(s).

If you are unable to increase the flow rate, please contact your pool dealer as you may need to increase the size of the filtration pump **or there is a lack of gas refrigerant**. Loss of refrigerant gas is normally attributed to transit damage or the heater being manhandled incorrectly. In the unlikely event that there is a refrigerant loss a replacement heater maybe required.

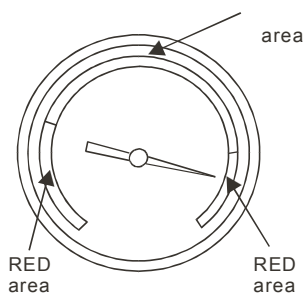

B

diagram 3

In the event that the pressure reading is in the red area 'B' (dia.3) it means the water flow is too high. You may need to install a bypass to decrease the water flow until pressure meter enters the green area. Please contact you dealer for advice.

CONTROL PANEL FUNCTION - ERROR DISPLAY 1-4



IF THE HEATER STOPS WORKING ONE OF THE FOUR ERRORS WILL BE DISPLAYED
THE FAILURE LIGHT WILL BE ON AND THE RELEVANT CODE WILL START TO FLASH

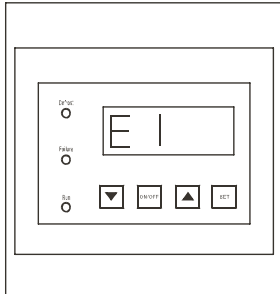

E1: the water temperature sensor is not working correctly.

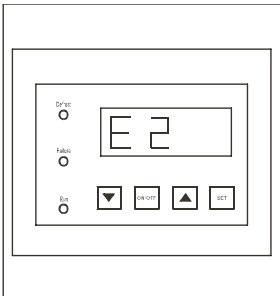

E2 : the tube sensor is not working correctly. Please contact your dealer.

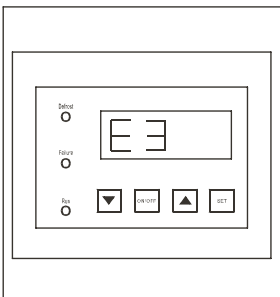

E3 : Pool filtration is running but water flow is not sensed. 'Flow Switch' may not be working properly or there is a lack of water flow. Backwash filter and check suction lines (Skimmer(s) & Main Drain(s) for obstruction.

PLEASE ALSO SEE PAGE 15 - FILTRATION & FAQ

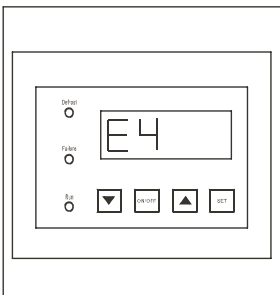

E4 : Indicates high water/refrigerant pressure. High limit pressure switch has activated and turned off power supply.

AUTO RESTART AND DEFROSTING FUNCTION



AUTO RESTART FUNCTION

The Alto water heat pump has an auto restart function. When the power supply is switched off accidentally, it will automatically save the operation mode.

When the power supply is restored, the unit will automatically restart after five minutes and operate in the same working mode.

REVERSE CYCLE DEFROST FUNCTION

When the ambient air temperature is too cold, the evaporator will start to freeze and frost will appear on the evaporator fins. If this happens the heater will automatically enter a defrosting mode (Reverse Cycle Defrost) and the defrost light will show in the control panel.

This function will make the unit run as it would if it were a normal cooling unit by heating the outdoor coil using hot gas to melt any frost / ice. Once the evaporator temperature has reached over 23C or the set defrosting time, the defrost function is over and reverts back to heating the pool water.

FILTRATION -

BACKWASHING (FILTER) - ONLY APPLICABLE IF FLOW SWITCH HAS NOT BEEN INSTALLED

The Alto water heat pump will continue to run when the filter is being backwashed. Although there is no water flow through the heat pump it will automatically cut out after a short period of time. Heat pump will automatically restart when filter is put back to normal operation.

WASTE - ONLY APPLICABLE IF FLOW SWITCH HAS NOT BEEN INSTALLED

If the pool is to be emptied or cleaned through the waste cycle for long periods of time we recommend that the heat pump is manually turned off until filter is functioning normally..

FAQ

The flow switch is faulty, is there a way to bypass the flow switch temporarily?

Yes. Re-insert the 'pre-fitted loop (see page 6). Heater will need to be turned on and off manually until a replacement is sent.

How long will it take to heat up my pool?

The answer to this is dependant on a number of factors; the ambient air temperature; heater being sized correctly; solar cover fitted; plumbing configuration etc. As an indication, at the start of the summer season (May) you should be able to obtain a water temperature of 24°C / 75°F allowing for approximately one week heat up time. This is providing that filtration is running 24hrs per day and an average ambient air temperature of 16°C / 61°F is achieved.

When I use a heat pump, should I use a pool cover or solar blanket as well?

Yes. Any reduction in pool heat loss directly translates into savings. 82% of all losses are due to convection. Using a pool cover just at night will save about 40% of the annual heating cost. A thermal pool cover or solar blanket can significantly reduce pool heating loss. The use of a solar or thermal blanket will also help extend your pool season.

What is the minimum ambient operating temperature?

The Alto Water Heat Pump will actually operate down to an ambient air temperature of 0°C. but with minimal heat output. Therefore we recommend that the minimum operating temperature should be 5°C. Other conditions such as wind, shade and physical location will affect the shut-off temperature of the unit.

Will the heat pump require more refrigerant gas?

Unless the Alto Water Heat Pump has a leak in the sealed refrigeration system, the factory charge of Freon should last for the life of the unit. Freon is very stable and should not degrade or breakdown even under severe operating conditions. If your unit needs Freon, then it has a leak, and adding Freon will not solve the problem. The leak must be located and repaired. Fortunately, Freon leaks are very uncommon and usually are due to transit damage.

How Close To Your Pool?

Normally, the pool pump and Heat Pump are installed close together and within 25 feet of the pool. The longer the distance from the pool, the more heat loss from the piping. Since normally most of the piping is buried, the heat loss is minimal for runs of up to 50 feet (50 feet to and from the pump = 100 feet total) unless the ground is wet or the water table is high. A very rough estimate of heat loss per 100 foot is 2500 BTU/hr for every 10° F difference in temperature between the pool water and ground surrounding the pipe, which translates to about 3% to 5% increase in run time.

WATER CHEMISTRY

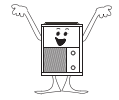

The following water quality must be maintained at all times to prevent premature corrosion. It is recommended that your water balance is checked and balanced by a pool professional. Your warranty does not cover for damaged caused by poor water chemistry and neglect.

pH:	7.2 -7.6
Total Alkalinity:	80 - 120ppm
Total hardness:	Less thab 500ppm
Total Dissolved solids:	1500ppm or lower
Saline Water max:	concentration 6%
Chlorine Free Cl:	5ppm Max. Continuous
Cyanuric level	50ppm Max.
Super chlorination Max:	30ppm for 24hrs
Bromine:	8ppm
Baquacil:	25-50ppm

Surface skimmers (above or inground)

Do not use slow dissolving chemical tablets such as chlorine in the skimmer basket(s). This can lead to high acidic/corrosive pool water affecting the heat exchanger and resulting in a replacement of the whole unit. Therefore, we recommend that diluted chemicals are fed directly to the pool water or use an automatic dosing device.

WINTERISING / START-UP procedure - ALL MODELS

Winterising Procedure

1. Switch off electric supply to heat pump.
2. Turn off circulation pump.
3. Drain water from heat pump by disconnecting pipework to and from heat pump.
Ensure Heat Pump is completely drained.
4. Flush through water circuit in heat pump using clean tap water i.e. a hose into inlet connection - run for 10 minutes minimum.
5. Drain completely - fit plastic bags secured by elastic bands over water connections.
6. If desired, you can protect from the heater by covering with VENTILATED cover through the winter season. Do not use plastic sheet as condensation can occur within unit.

NOTE. If the pool has a 'frost-thermostat' installed to prevent the pool system from being drained in the winter months, it is recommended that a plumbing by-pass is installed to prevent unnecessary water flow through the heater unit.

Start-Up Procedure

1. Remove ventilated cover protection is fitted.
2. Re-connect all plumbing connections to heat pump, filtration etc.
3. Turn on circulation pump and check for leaks.
4. Use control panel to set functions 1-7.
5. Check daily to ensure pool water has the correct pH and the correct chemical balance is being maintained.

ALTO WARRANTY POLICY



This voluntary policy is supplemental to and in no way affects any statutory rights which the customer may have.

1 Warranties

- 1.1 Paramount Pools warrants the Alto Heat Pump for a period of one (1) year from the date installed for both parts and labour.
- 1.2 At the end of the first year the following warranties apply as to parts only; labour is excluded from these warranties:-
 - 1.2.1 The condenser and compressor are warranted for three (3) years;
 - 1.2.2 The stainless steel copper heat exchanger is warranted for three (3) years;
 - 1.2.3 The titanium heat exchanger is warranted for five (5) years.

2 Exclusions - This warranty does not include the following:-

- 2.1 The repair of damage due to negligence; abuse or improper installation;
- 2.1 Incorrect winter de-commissioning;
- 2.3 Improper operation;
- 2.4 Improper use of pool chemicals;
- 2.5 Operation environment;
- 2.6 Failure to provide reasonable and necessary maintenance;
- 2.7 Accident or other conditions beyond the normal intended use of the unit;
- 2.8 Any misuse of the equipment;
- 2.9 The occurrence of superficial corrosion to the external housing cabinet of the heat pump;
- 2.10 The furnishings of refrigerant and other expendable material.

3 Conditions for Warranty

The warranty only applies on the following conditions:-

- 3.1 The customer is to pay for all charges for the Alto Heat Pump in accordance with the original terms of sale.
- 3.2 All repairs, replacements must be carried out by an **authorised service agent** appointed by Paramount Pools.
- 3.3 This warranty extends only to the original consumer who purchased the Alto Heat Pump.
- 3.4 The warranty terminates upon the transfer of ownership or if the heat pump is relocated save with the written permission of Paramount Pools.
- 3.5 The warranty is only applicable to installations in England, Scotland and Wales.

4 Damages

- 4.1 Paramount Pools is not liable for any damages of any sort whatsoever, including incidental and consequential damages.
- 4.2 Parts returned under the terms of this warranty will be repaired or replaced and return transportation charges pre-paid within the UK by the best and most economical means
- 4.3 To the extent permitted by law liability under or in connection with this warranty whether arising in contract or negligence; breach of statutory duty or otherwise, shall not exceed the value of the contract.

5 Miscellaneous

- 5.1 This warranty shall be governed by and construed in accordance with the laws of England and Wales and each party agrees to submit to the jurisdiction of the Courts within England and Wales.
- 5.2 This warranty is in lieu of all other warranties expressed or implied, written or oral save as prescribed by statute.
- 5.3 There are no implied warranties of fitness for a particular purpose that apply to this product.
- 5.4 Any provisions of this contract which is or may be void or unenforceable shall to the extent of such invalidity or unenforceability be deemed severable and shall not affect any other provision of this contract.

HEAT PUMP SERVICE

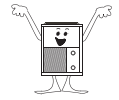

An Alto heat pump should give you many years trouble free service. However, to obtain the maximum efficiency from your heater Alto recommend that your heater is checked and serviced every 12 months. Service & extended warranty packages are available from a UK Service Agent (see contact detail below).

HEAT PUMP BREAKDOWN

If you think there is a problem with your heater and are not able to diagnose the fault please contact your **POOL DEALER** initially to discuss the symptoms.

BEFORE YOU CALL

To help you prevent unnecessary service call outs, please check the following points:-

- Is there an electric supply to the heater?
- Is there a power cut?
- Have you checked all the house fuses, R.C.D trip?
- Has the electrical supply been disconnected?
- If installed is the time clock correct?
- Have checked you the flow metre?
- Is there enough water flow?
Has the filtration been running for a minimum of twelve hours per day?
- Is there any obstruction in the skimmer?
- Is there any obstruction in the pump basket?
- Is the water at the correct operational level?
- Is the filter pump working?
- Is the filter operating pressure correct?
- Does the filter require backwashing?
- Have you checked the diagnostic control panel?

If the fault can not be diagnosed over the phone then your pool dealer will contact **Paramount Pool Products (UK Importer)** who will arrange an appointed UK SERVICE AGENT (Regal Environmental Systems Ltd) to contact you with a suitable date and time to service the heater unit.

Please have the following information available:-

1. Serial number (located on the aluminum plate placed externally on the heat pump casing) and the approximate date the unit was installed. (this information should be on the front cover of this manual)
2. Proof of Installation Date (Bill of sale or original invoice only)
3. Description of the Symptoms.

UK IMPORTER: Paramount Pool Products London Road Hartley Wintney Hook Hants RG27 8HY TEL. 01252 842891 FAX 01252 842388

UK SERVICE AGENT: Regal Environmental Systems Ltd Regal House Upham Street, Upham, Southampton SO32 1JA TEL01489 860966 FAX 01489 860977

ALTO HEAT PUMPS - SPECIFICATION

Model No.	AS-H40Y 12kW	AS-H50Y 15kW	AS-H60Y 18kW
Heating Capacity (Btu)	40000	50000	60000
Cooling Capacity (Btu)	35000	42000	55000
Rated Input (W)			
Heating	2540	3185	3790
Cooling	2465	3020	3900
PTC Power (W)	-----	-----	-----
COP for Heating (w/w) (at 20 °C ambient air temperature)	4.42	4.40	4.44
Refrigerant	R407C	R407C	R407C
Power Supply			
Volt/Phase/Hz	230/1/50	230/1/50	230/1/50
Rated Current (A) -Heating	11.3	14.1	16.8
Cooling	10.9	13.4	17.3
LRA (A) - (Max. Start-up AMPS)	32	36	40
Minimum Flow Rate m3/h (imp.gls)	2.5 (550 gls)	2.5 (550 gls)	2.5 (550 gls)
Maximum Flow Rate m3/h (imp.gls)	10.0 (2200 gls)	13.0 (2850 gls)	18.0 (3975 gls)
Noise Level (whole unit) at 3m	<52	<54	<58
System			
Compressor type	ROTARY	ROTARY	SCROLL
Electric expansion valve	Y	Y	Y
Features			
Electronic Control Panel	Y	Y	Y
Soft Touch Key Pads	Y	Y	Y
LCD Display	Y	Y	Y
Temperature Indicator(°C)	5~45	5~45	5~45
Drain Hose connection	Y	Y	Y
Dimensions WxHxD (mm)			
Net Weight (Kg)	480×755×515 65	580×715×610 74	580×715×610 98
Packing Dim. WxHxD (mm)	540×835×540	630×770×710	630×770×710
Gross Weight (Kg)	70	84	110

USEFUL CONVERSIONS

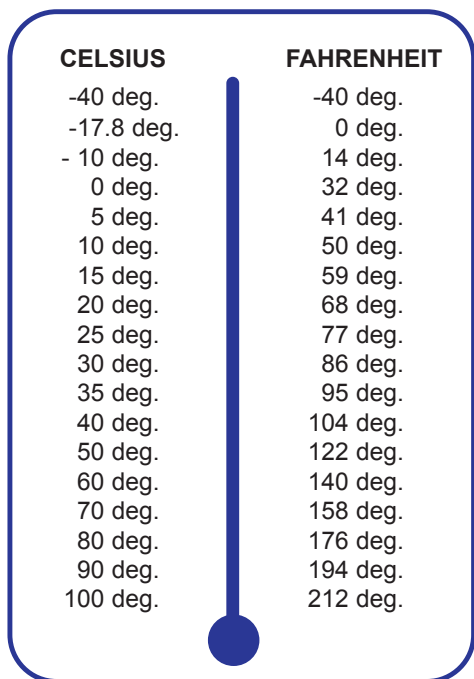

1,000 British Thermal Units (BTU) = 0.293 kilowatt/hour
 10,000 BTU = 1 therm
 1 UK Horsepower = 0.7457 kilowatt

Cubic Yards to Cubic Metres multiply by 0.764555
 Cubic Metres to Cubic Yards multiply by 1.30795
 Cubic Metres to Gallons multiply by 220.717
 Gallons to Cubic Metres divide by 220.717

Gallons to Litres multiply by 4.546
 Litres to Gallons multiply by 0.22

POOL CAPACITY / VOLUME

To calculate pool capacity measure the Length 'L' - Width 'W' - and average water depth 'D'.

SQUARE OR RECTANGULAR POOLS
 CAPACITY = L X W X D X 6.25 gallons (U.K)

ROUND OR OVAL POOLS
 CAPACITY = DIA. X DIA. X DEPTH X 4.90 gallons

PUMP CONVERSION

Horse power to Watts x 746
 Watts to Horse Power x 0.00134

AREA

Surface area of a Circle 3.14 x Radius(squared)
 Perimeter of a circle 3.14 x Dia.