



Ag Leader[®]
Technology

GPS 1500 User Manual
PN 2005906 Rev. E

OVERVIEW

INTRODUCTION

The GPS 1500 is a smart antenna that tracks GPS and SBAS (WAAS and EGNOS) signals.

CABLE CONNECTIONS

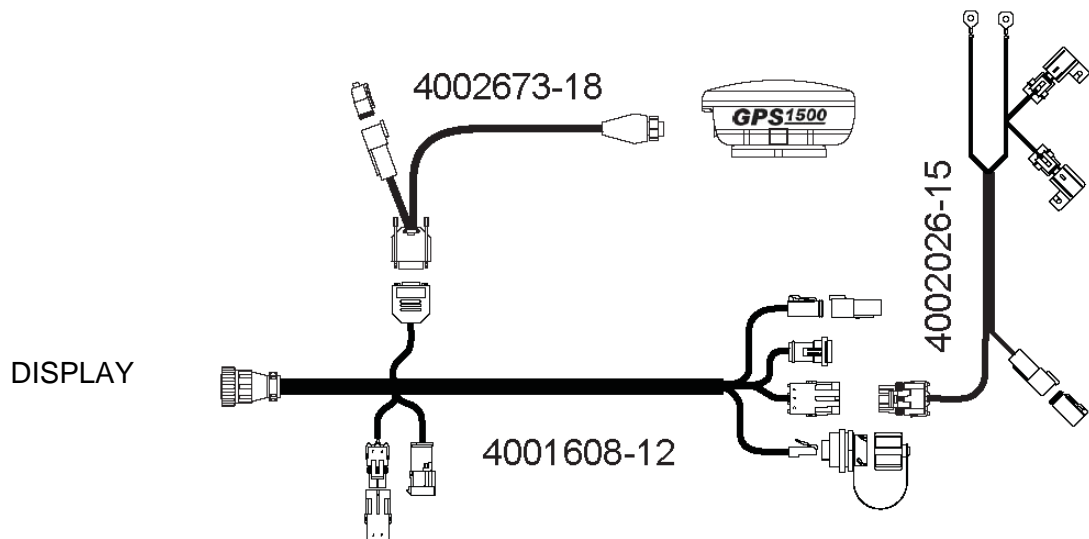

GPS OVERVIEW

The receiver is preconfigured and will work out of the box for most applications. When powered for the first time, the receiver will perform a “cold start,” which involves acquiring the available GPS satellites in view and the SBAS differential service.

GPS OPERATION

The GPS engine is always operating, regardless of the DGPS mode of operation. The GPS engine automatically searches for GPS satellites, acquires the signals, and manages the navigation information required for positioning and tracking.

Receiver Performance

The receiver finds four or more GPS satellites in the visible sky and uses the information provided by those satellites to compute an appropriate position (typically within 2-3 meters). Since there is some error in the GPS data calculations, the receiver also tracks a differential correction. It uses these corrections to improve its position to less than 1 meter (3 feet)

There are two main aspects of receiver performance:

- Positioning
- Satellite acquisition quality

Satellites transmit coded information to the receiver in a specific frequency that allows the receiver to calculate a distance to each satellite. GPS is essentially a timing system. The distance is calculated by timing how long it takes the signal to go from the satellite to receiver.

The receiver uses a complex algorithm incorporating satellite locations and ranges to each satellite to calculate the geographic location. Reception of any four or more of these signals allows a GPS receiver to compute three-dimensional coordinates.

DIFFERENTIAL OPERATION

The Radio Technical Commission of Marine services (RTCM) has a differential service intended for correction services. This includes the Space Based Augmentation Systems (SBAS), such as the Wide Area Augmentation System (WAAS) and the European Geo-stationary Navigation Overlay System (EGNOS). The GPS 1500 is compatible with each of these differential services.

SBAS

A SBAS-enabled receiver operates automatically anywhere within the coverage areas of the WAAS, EGNOS or other SBAS programs.

WAAS and EGNOS explained

- WAAS is a free service of the Federal Aviation Administration (FAA) that allows regular GPS positions to be improved to a DGPS level of accuracy. WAAS is available everywhere in the U.S., including Alaska, Hawaii and Puerto Rico. It can also be picked up in some of the border areas of Mexico and Canada. There are no subscription charges incurred when using WAAS.
- EGNOS is a similar service that is available in Europe and western Russia.

Automatic SBAS tracking

The receiver will automatically scan and track satellite signals. This automatic tracking allows you to focus on other aspects of differential operation without the need to tune the receiver. The GPS 1500 features two-channel SBAS tracking that provides an enhanced ability to maintain a lock on a SBAS satellite when more than one satellite is in view. This redundant tracking approach results in more consistent tracking of a SBAS signal when in an area where signal blockage of a satellite is possible.

e-Dif

A receiver that is equipped with e-Dif capabilities can operate anywhere in the world where normal GPS signals can be viewed. e-Dif can be used anywhere on the globe where a GPS lock can be achieved.

e-Dif is for our customers who are not able to receive other types of differential signals due to location or budget.

Once the receiver computes a differential correction, the user can operate for unlimited time and provide good relative accuracy. Alternatively, the operator can regularly update e-Dif to maintain absolute accuracy (typically less than 1 meter over 40 minutes).

SETUP

UTILITY SETUP PROCEDURE

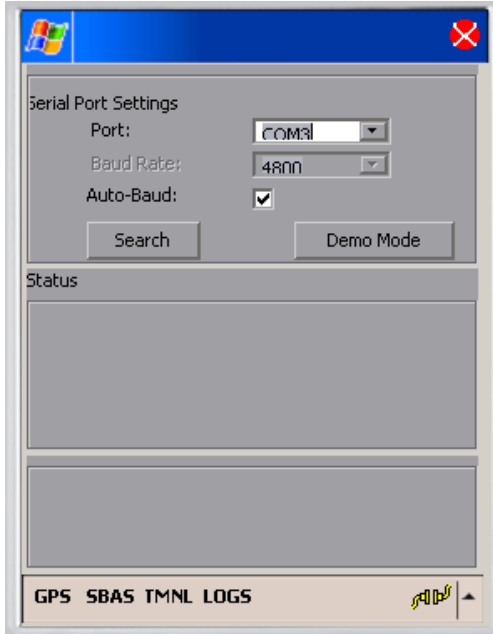

The default GPS settings are 4800 baud, 1 Hz GGA and VTG NMEA strings. These settings will work for all Ag Leader products. However, if the equipment that you are using requires higher baud or Hertz rates, you may need to reconfigure the GPS using the following procedure.

1. Download the Pocket Max PC.exe executable file from Ag Leader's web site:
<http://www.agleader.com/support.php?Page=downloads>
2. Double click on Pocket Max PC.exe.
3. The Pocket Max PC program appears. On the Serial Port setting, select the correct COM Port that the GPS is connected to. Also, check the Auto Baud check box.

Pocket PC with COM Port and Auto-Baud selected

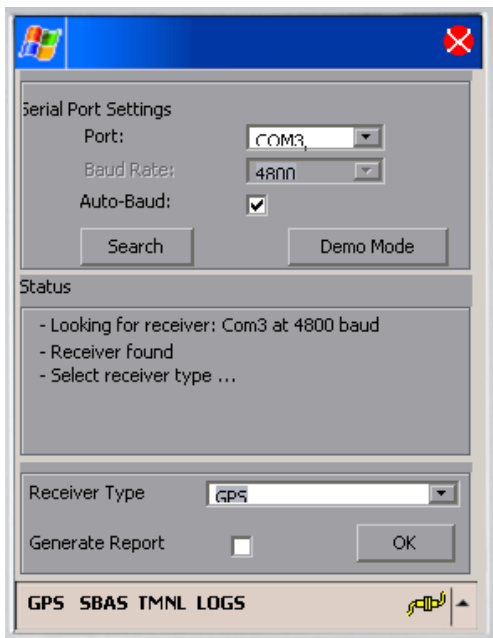

4. Press the Search button. The utility then searches for the correct GPS receiver.

Utility after finding correct GPS receiver with OK button showing



Note: If the utility cannot find the correct GPS receiver, use a different COM port and repeat. Also, make sure that the GPS is powered.

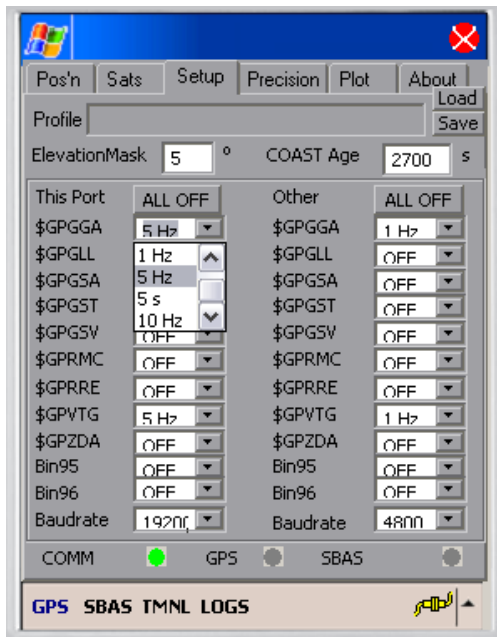

5. Once the utility finds the correct GPS receiver, the OK button appears at the bottom of the window. Press the OK button.
6. When the new window appears, click the Setup tab.
7. Under the “This Port” column, (located on the left-hand side of the window) use the drop-down menu to select the correct Hz rate, such as 5 Hz.

Selecting correct Hz rate on a NMEA string



Note: Ag Leader’s products require the GGA and VTG NMEA strings. To find out the required NMEA strings for other products, check with the manufacturer

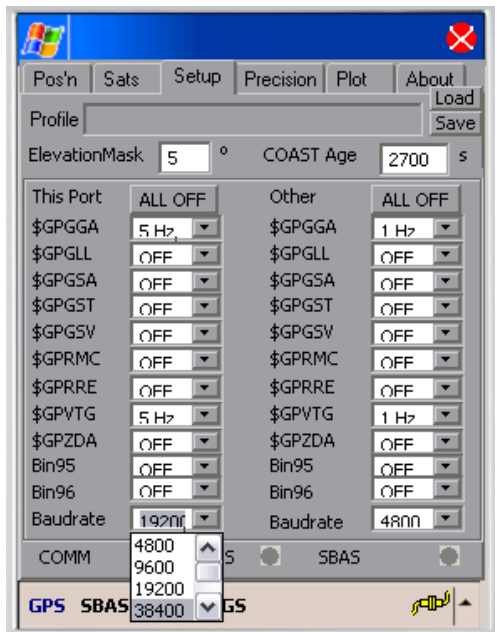



8. At the bottom of the drop-down menu, select the correct baud rate. These range between 4800 and 115,200.
- Ag Leader’s PF series monitors require a 4800 baud rate.
 - Ag Leader’s InSight, EDGE and INTEGRA displays cannot use a baud rate higher than 38400.

Selecting correct baud rate

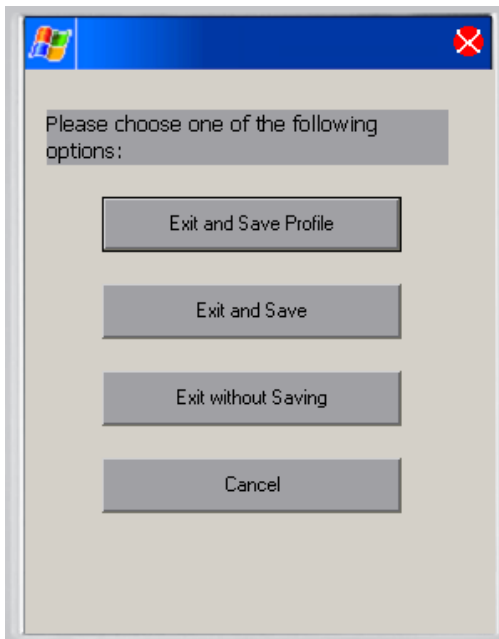

Note: At this time, the 57600 and 115200 baud rates are not supported by Ag Leader displays.



9. When setup is complete, press on the Exit button, which is the red X  located in the right-hand corner of the window.

10. The Exit Options window appears, asking you to choose one of the following options. Always press Exit and Save.

Exit Options window



Note: If you choose a selection other than Exit and Save, your settings will not be saved.

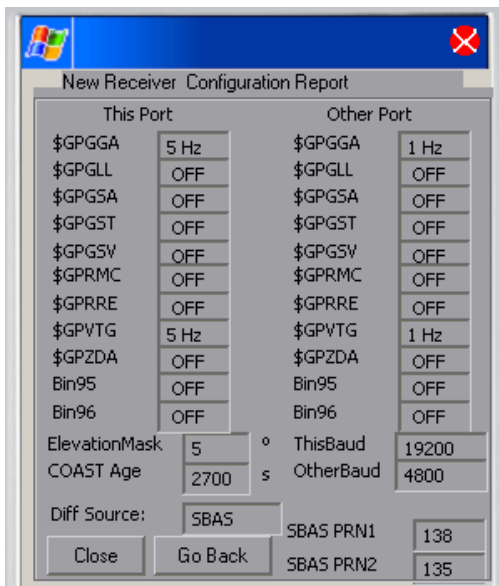

11. A series of messages appears, after which a Configuration Report will appear. At the configuration report, you can view your saved settings. However, you cannot make changes to these settings at this window

12. Press Close to end the utility program

New Receiver Configuration Report

INSTALLATION

The GPS 1500 is a smart antenna that tracks GPS and SBAS (WAAS and EGNOS).

Deutsch Connector Receptacle

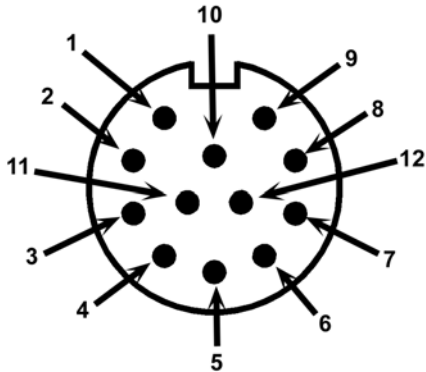

The picture provides a front view of the Deutsch connector receptacle's numbering.

Deutsch connector receptacle numbering

DB-9 CONNECTION TABLES

DB-9 Connection for Cable 4002673-18

Signal	GPS	Wire Color	DB-9	Deutsch Receptacle
Manual Mark In	1	Violet		
TXB	2	White		
RXB	3	Gray		
Can High	4	Pink		
Signal Ground	5	Brown		
TXA	6	Green	3	
One PPS	7	Orange		
RXA	8	Blue	2	
Can Low	9	Tan		
Power In (12V)	10	Red	4	
Power Ground	11	Black	5	2 (Black)
Speed Out	12	Yellow		1 (White)

HDB-15 Connection for Cable 4002674-18

Signal	GPS	Wire Color	HDB 15	Deutsch Receptacle
Manual Mark In	1	Violet		
TXB	2	White		
RXB	3	Gray		
Can High	4	Pink		
Signal Ground	5	Brown		
TXA	6	Green	14	
One PPS	7	Orange		
RXA	8	Blue	13	
Can Low	9	Tan		
Power In (12V)	10	Red	10	
Power Ground	11	Black	11	2 (Black)
Speed Out	12	Yellow		1 (White)

DB-9 Connection for Cable 4002675-18

Signal	GPS	Wire Color	DB-9	Deutsch Receptacle	Cigarette Plug
Manual Mark In	1	Violet			
TXB	2	White			
RXB	3	Gray			
Can High	4	Pink			
Signal Ground	5	Brown			
TXA	6	Green	2		
One PPS	7	Orange			
RXA	8	Blue	3		
Can Low	9	Tan			
Power In (12V)	10	Red			1 (White)
Power Ground	11	Black	5	2 (Black)	2 (Black)
Speed Out	12	Yellow		1 (White)	

CABLE INTERFACE

The cable options include:

- DB9 serial
- Speed
- Power

Additional extension cables may be purchased, as necessary, for other installations. This allows the receiver to be quickly and easily moved from one installation to another. If an extension cable is damaged in the field, it can be replaced without returning the complete system.

EXTENSION POWER/DATA CABLE

The system is quickly installed with one of the various extension cables. Keep in mind that the data connector communication port must reach to connect to a data storage device or guidance system.

When choosing a route for the extension cable:

- Avoid running cables in areas of excessive heat.
- Keep cables away from corrosive chemicals.
- Keep the cables away from rotating machinery.
- Do not bend excessively or crimp the cables.
- Avoid placing tension on the cables.
- Remove unwanted slack from the extension cable at the receiver end.
- Secure along the cable route using plastic wraps.



WARNING: *Improperly-installed cables near machinery can be dangerous*

ROUTING THE CABLE TO THE CAB

Follow these steps to route cable into the cab:

1. Find a place on the right side or bottom of the cab to route cable into cab (the point of entry is up to you).



Note: *The cable can be routed through windows or doors but make sure that there will be no damage to the cable.*

2. Attach the GPS cable from the antenna to Port 1 of the PF3000, Port 1 on the YM 2000, or the GPS port on the InSight, EDGE or INTEGRA display.

- If you are attaching the receiver to a PF Advantage or PF 3000 Pro without GPS, attach the GPS cable to AUX. 1 Port.
- If you are connecting your receiver to an alternative logging or mapping device (i.e. handheld or laptop computer), refer to your Operator's Manual for that particular unit for correct cable connection.

Cable Part Numbers

INTEGRA, EDGE, InSight, PF3000, YM2000: 4002673-18

PF Advantage: 4002674-18

Mobile Logging (Laptop and Handheld): 4002675-18

MOUNTING THE GPS 1500

PLACEMENT ON VEHICLE

Placement is crucial to the system's operation. The GPS engine inside the receiver computes a position based upon measurements from each satellite to the internal GPS antenna unit. Mount the receiver on your point of interest. When choosing a location to mount the antenna, please make certain that there is an unobstructed view of the sky available to the GPS 1500 smart antenna. This will ensure that GPS satellites are not masked by obstructions, which can potentially reduce system performance.

To place the GPS 1500

1. Mount the receiver on, or as close to, the center of your point of measurement.
2. Position the receiver as high as possible.

Below is an illustration of the ideal location to place the receiver on a vehicle.



GPS 1500 placement on a vehicle

RADAR SPEED OUTPUT

The receiver is capable of outputting a simulated radar speed pulse. This simulates a similar pulse output that you would receive from a standard radar gun.

To use the radar speed input you must set the speed input to RADAR under the appropriate setup screen for the monitor/display. Additional cables will also be required to obtain the simulated speed output. Contact Ag Leader's AutoFarm's Technical Support team for these additional cables.

RADAR SPEED COMPATIBILITY

Adaptor cables are available through Ag Leader TechnologyAutoFarm for the following three brands of monitors: Dickey-John, Raven, and Hiniker. These adaptor cables provide the ability to use the GPS 1500 in place of a radar gun. If using the receiver as a stand-alone antenna, you will need to obtain an Auxiliary Power/Data Cable and the appropriate Radar Speed Adaptor Cable.

RADAR SPEED DEFAULT SETTINGS

The default output parameter provided in the receiver is a minimum output speed of .5 miles per hour (.8 kilometers per hour), meaning speed pulses will not be output below this speed. The default radar pulse output rate is 45 Hz per 1 MPH.

Radar Speed Adaptor Cables

Hiniker adaptor cable: 3000478

Raven adaptor cable: 3000479

Dickey John adaptor cable: 3000480

CONNECTIONS TO EXTERNAL DEVICES

The serial ports of the GPS 1500 operate at the RS-232C interface level to communicate with external data loggers, navigation systems and other devices. The serial ports are accessible via the extension cable that features a DB9 female data connector. The serial ports are also used for firmware updates.



Note: For successful communication, the baud rate of the GPS 1500 serial ports must be set to match that of the devices to which they are connected.

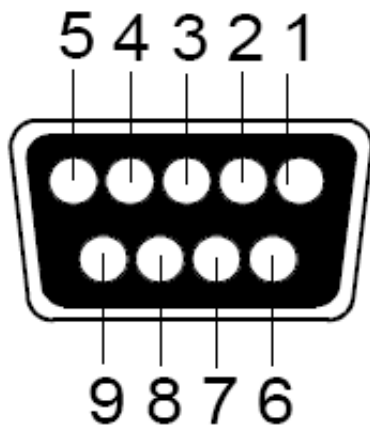

The picture displays the numbering for the extension cable's DB-9 socket connector (female). The associated numbering for the plug connector (male) is a mirror reflection of the scheme shown below.

DB-9 socket numbering

FACTORY PARAMETERS

Serial Port Settings

This table identifies default settings for the GPS 1500 configuration.

Serial Port	Baud Rate	Data Bits	Parity	Stop Bit	Interface Levels	Update Rate
Serial port A	4800 9600 19200 38400	8	None	1	RS-232C	1 to 10 Hz

TROUBLESHOOTING

LED STATUS INDICATORS

The GPS 1500 uses one tri-colored LED, which indicates important status information.

- Red indicates the power is on
- Amber indicates a GPS lock
- Flashing green indicates DGPS is being acquired
- Green indicates a DGPS solution

VERIFYING DIFFERENTIAL GPS SIGNAL

Differential GPS (DGPS) is a data collection technique that uses extra GPS receivers and some complex calculations to increase the accuracy of GPS positions. DGPS is made possible because of an enhancement to the Global Positioning System that uses a network of fixed, ground-based reference stations to broadcast the difference between the positions indicated by satellite systems and other known fixed positions.

You should periodically check the monitor to ensure that you are receiving a Differential GPS signal, as this could affect the quality of the data you are logging. As an example, your GPS receiver must track four or more satellites to get an elevation reading.

TROUBLESHOOTING CHECKLIST

The following is a checklist to troubleshoot common problems and their solutions for the GPS 1500.

Receiver fails to power

- Verify polarity of power leads
- Check integrity of power cable connections
- Check power input voltage (7 - 36 VDC)
- Check current restrictions imposed by power source (maximum is 250 mA)

No data from receiver

- Check receiver power status (LED)

- Check integrity and connectivity of power and data cable connections
- The volume of data requested to be output by the receiver could be higher than what the current baud rate supports. Try using 4800, or higher, as the baud rate for all devices.

No GPS lock

- Check integrity of cable connections
- Verify receiver's unobstructed view of the sky

No SBAS lock

- Check integrity of cable connections
- Verify receiver's unobstructed view of the sky
- Check SBAS visibility map

APPENDIX

SPECIFICATIONS

The following three tables provide the power, mechanical, communication, environmental and DGPS specifications for the GPS 1500.

Power Specifications

- *Input voltage: 7 - 36 VDC*
- *Power consumption: < 2 W @ 12 VDC (typical)*
- *Current Consumption: 150 mA @ 12 VDC (typical)*
- *Power connector: Cable mount environmentally sealed*

Mechanical Specifications

- *Height: 54.7 mm (2.2in)*
- *Width: 129.5 mm (5.1 in)*
- *Weight: 0.66 kg (1.45 lbs)*
- *Mounting Options: Magnetic mount*

Environmental Specifications

- *Operating temperature: -30° C to +70° C (-22° F to + 158° F)*
- *Storage temperature: -40° C to +85° C (-40° F to + 185° F)*
- *Humidity: 100%*
- *Enclosure: Waterproof and dust proof*
- *Compliance: FCC, CE*
- *Shock: IEC 68-2-27*
- *Vibration: ISO 16750-1*
- *EMI certification: FCC part 15, E-Mark*

GPS 1500 ACCESSORIES

- *GPS 1500 Receiver: 4001372*
- *Antenna Bracket - L-shaped: 2000161*

Documentation

- *GPS 1500 User Manual: 2005906*
- *Product Registration: 2002868*

Cables

- *Cable for YM 2000, PF 3000, InSight, EDGE and INTEGRA displays: 4002673-18*
- *Cable for PF Advantage: 4002674-18*

COMPANY WARRANTY STATEMENT

WARRANTY

Ag Leader Technology will repair or replace at no charge any component of the GPS 1500 that fails during normal service, while being used in an approved application, within two years of the warranty start date. Warranty is not provided for damage resulting from abuse, neglect, accidents, vandalism, acts of nature, or any causes that are outside of the normal intended use of the receiver. Ag Leader Technology shall not be liable for indirect, incidental, or consequential damages to the dealer, end user, or third parties arising from the sale, installation, or use of any Ag Leader Technology product.

COPYRIGHT NOTICE

Ag Leader Technology has copyrighted (© 2011) the contents of this manual. No reproductions may be made without first obtaining the consent of Ag Leader Technology.

SERVICE AND SUPPORT

If you have additional questions or feel that you may be having a problem with your system, call your local Ag Leader Technology dealer or call us directly at the phone number below. If we determine you have a hardware failure, we will ship replacement hardware immediately.

Our Technical Support Department can be reached by phone at 515-232-5363, extension #1; or through email at support@agleader.com.

PRODUCT REGISTRATION

Ag Leader Technology stands by all new products with a two-year limited warranty from the warranty start date. The warranty start date will initially be set to the date on which your product is shipped from Ag Leader Technology.

If you return this registration/warranty card within 30 days of purchasing this product from your dealer, the warranty start date will be changed to the date that you purchased the product from your dealer. Ag Leader Technology reserves the right to request proof of the date of purchase stated.

Timely product registration will allow you to receive important product bulletins, upgrade information, and notice regarding product training in your area.

TO REGISTER:

Register On-Line at www.agleader.com. Click on Product Registration from the Quick Links list on the Ag Leader Home Page.

OR

Return this sheet in the enclosed postage-paid envelope; or by FAX: 515-232-3595.

Ag Leader Technology
2202 South Riverside Drive
P.O. Box 2348
Ames, Iowa 50010

Name: _____

Street Address: _____

City, State, ZIP: _____

Phone # (including area code): _____

Mobile Phone #: _____ Fax #: _____

Email address: _____

Ag Leader Dealer: _____

Date Purchased: _____

GPS Antenna Serial #: _____