

**CONTENT**

1.	Manufacturer	1
2.	General safety information's	1
3.	Purpose	2
4.	Product compliance	2
5.	Degree of protection and technical data	2
6.	Types	3
7.	Luminaire characteristics	3
8.	Dimensions	3
9.	Mounting and installation	3
10.	Spare parts and accessories	4
11.	Inspection, maintenance, repair and overhaul	4
12.	Responsibility and authorization	5
13.	Storage and transport	5
14.	Manufacturer's warranty	5
15.	Marking	5

**1. MANUFACTURER**

TEPEX d.o.o.  
Prilaz dr. Franje Tuđmana 6 HR-49210 ZABOK  
Telefon: +385 49 222 900  
Internet: www.tepex.hr

**2. GENERAL SAFETY INFORMATIONS****WARNING!**

The user manual contains basic information about the product. Mounting, installation, usage and maintenance should be carried out under this user manual to provide and ensure safe operation within the nominal characteristics. This user manual complement national Regulation and Standards. The responsible person shall ensure their implementation. Failure off implement this user manual can reduce explosion protection and endanger people, property and the environment. Any improper and illegal actions as well as non-compliance with the provisions of this user manual excludes all responsibility by manufacturer side.

**Before installation/commissioning:**

- Carefully read all instructions,
- Execute proper training of responsible personnel,
- Check that the contents of these instructions is fully understandable by the responsible personnel,
- Make sure that all the requirements and national Regulations as well as all special security measures are applied.

**In lack of understanding:**

- Contact the manufacturer.

**During operation:**

- Ensure that this user manual and other work instructions are available to the responsible staff at all times,
- Check the implementation of these instructions and all other safety user's instructions.

### 3. PURPOSE

Explosion protected LED light fitting type FLX 310 LED, is intended for general lighting in industrial areas with potentially explosive atmosphere Zones 1, 2, 21, 22 in accordance with EN 60079-10-1/-2: 2009. The quality of the materials ensures compliance with standard functionality in standard industrial atmosphere. For special requirements please contact the manufacturer.

### 4. PRODUCT COMPLIENCE



The product complies with the ATEX Directive 94/9 EC and standard:

- EN 60079-0:2012 / A11:2013,
- EN 60079-1:2007,
- EN 60079-7:2007,
- EN 60079-31:2014.

The product has been developed, manufactured and tested according to the existing state of technique accordance with the standards EN 9001:2008 and EN ISO / IEC 80079-34:2011.

- The product is in compliance with the LV Directive 2006/95 EC.
- The product is in compliance with the RoHS Directive 20011/95 EC.
- The product is in compliance with EMC Directive 2004/108 EC
- 

### 5. DEGREE OF PROTECTION AND TECHNICAL DATA

Certificate:	EXA 15 ATEX . . . .
Category and explosion protection:	 II 2G Ex d e IIC T6 Gb II 2D Ex tb IIIC T80°C Db IP66
Ambient temperature:	-20 °C ≥ +50° C
Mechanical protection:	IP66 / IP67
Resistance to shock:	IK 08
Class of protection	I (PE - protective earthing)
Rated voltage	230 V AC
Frequency:	50/60 Hz
Rated power:	25 W
Power factor:	cos φ > 0,99
LED light source:	LED 3 x 8,8 W chip-on-board technology with OVP, OCP, OTP protection
Rated luminous flux:	3300 lm at tamb = 25°C
Light color:	4000 K
Refractive index(CRI):	>80
Estimated service life:	50 000 working hours tamb = 40°C L90/B10
Cable entries:	- two Ex d entries, M20x1,5-6H, according to EN 60079-1:2007, ISO 965-1, ISO 965-3 or - two Ex d entries, 3/4"NPT, according to ANSI/ASME B1.20.1
Terminals:	- screw terminals for L, N, PE, 2,5 mm <sup>2</sup> max per terminal, – sol(r), s(r), f
Ex d e adapter: (type FLX 310 LED / 3)	- tip ADP 23/1, II  2G Ex d e IIC Gb II 2D Ex tb IIIC Db, cable gland ISO 25 for cables Ø <sub>v</sub> 7-15 mm
Terminals inside Ex d e adapter:	- terminals for phase and neutral conductors L1, L2, L3, N; max 2 x 2,5 mm <sup>2</sup> sol(r), sol(s), f - terminal for protective earthing -PE; max 2 x 6 mm <sup>2</sup> sol(s), f - terminal for external grounding, equipotential bounding - max 2 x 6 mm <sup>2</sup> sol(s), f - torque screw for terminals is 1,2 Nm
External PA/PE terminal:	- max 2 x 6 mm <sup>2</sup> sol(r), sol(s), f - torque screw for terminals is 2,2 Nm
Torques:	- body of Ex d e bushings and Ex d plug 3,5 Nm - cable gland of the Ex d adapter 2,5 Nm - screw terminals of the Ex d adapter 1,2 Nm

## 6. TYPES

### FLX 310 LED

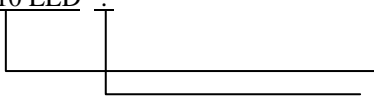

#### Basic type

#### Entry type

- 0 - Ex d cable entry 2 x M20, ISO 965-1, ISO 965-3
- 1 - Ex d cable entry 2 x 3/4"NPT, ANSI/ASME B1.20.1
- 2 - Ex d cable entry 2 x M20, ISO 965-1, ISO 965-3 with one Ex d e adapter type ADP 23/1 and one Ex d plug
- 3 - 2 x Ex d e adapters type ADP 24/1 for through-wiring

## 7. LUMINAIRE CHARACTERISTICS

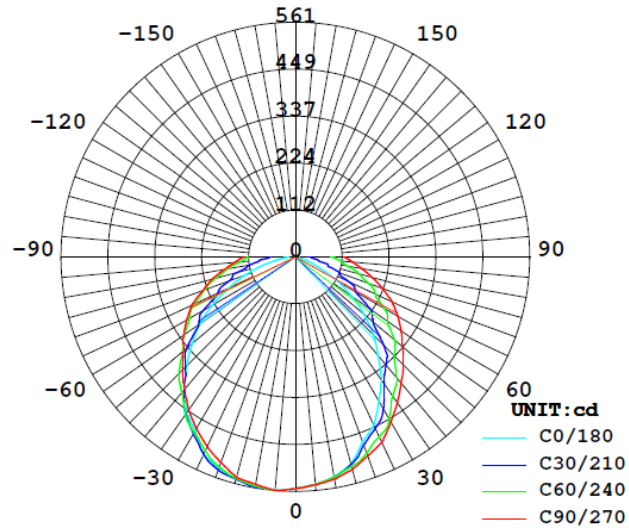

## 8. DIMENSIONS

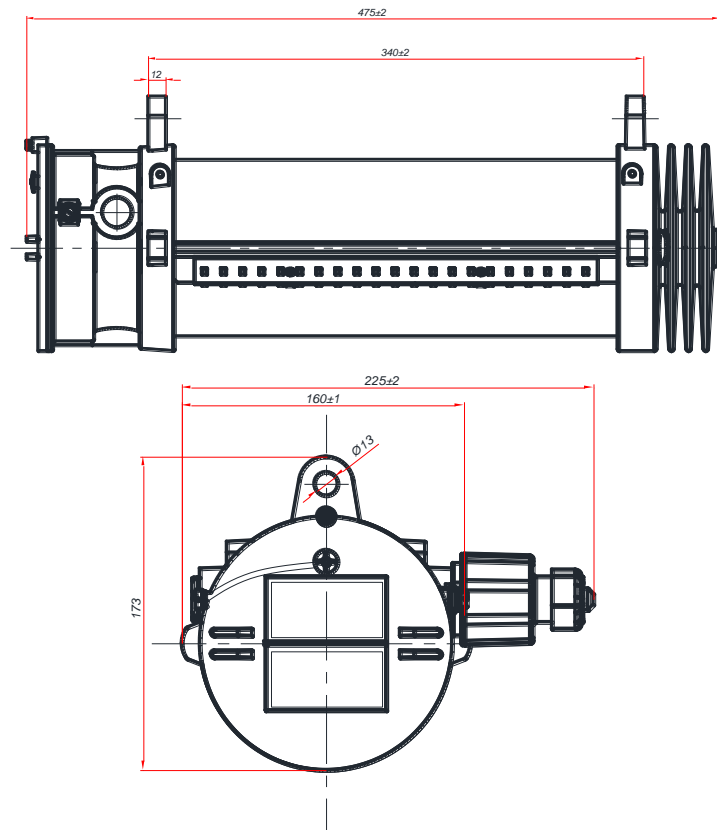

## 9. MOUNTING AND INSTALLATION

Mounting and installation of light fitting is carried out according to the labeled technical data and the additional manufacturer's instructions, national rules and regulations, as well as the generally recognized rules of technique. Only under this conditions the explosion protection that is committed with type certificate will be confirmed.

The quality of the used materials ensures compliance in the "standard" industrial atmosphere. For special requirements please contact the manufacturer.

Standard mounting is performed with suspension or fixing with a screws through an Ø13 mm hole in the housing. Using accessories for quick installation FLXE 20-170 can be directly fixed on the wall or ceiling - screw accessories Ø8 at a distance of 230 mm. Using accessories for quick installation FLXE 20-180 can be directly fixed on the pole with diameter up to 2".

Ex d cable glands and EX d plugs are not part of the standard delivery for the types FLX 310 LED/0 and 310 FLX LED/1, but it's ensured users. Standard design lamps presumed closure introduction with blind introductions to protect volumes. When installing the user should comply with the cable glands manufacturer instructions. If the user requests through-wiring, it is necessary to use two Ex de adapter or two Ex d glands

The light fitting comes with a cover fully twisted in its entirety in the housing and mechanically locked by a screw M5x10 ISO 4027 to protect from self-loosening. After each opening, lamp threat should be protected by protective agent threads.

Checking individual traceability of the quality control plan.







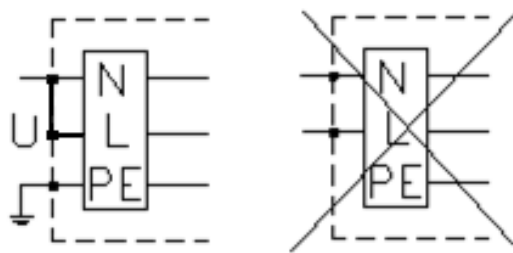



Testing the insulation resistance at 10 MW / 500 V DC.

Testing of mechanical strength of the casing with static pressure  $1,5P_{ref}$  for at least 10s.

Testing dielectric strength between L / N short circuit and  $\perp$  with test voltage (2UN + 1000 V) rms ie. 1500 V r.m.s. for min. 60 or the test voltage of 1.2 (2UN + 1000 V) rms ie. 1800 V r.m.s. for min. 100 ms.

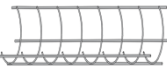

## 10. SPARE PARTS AND ACCESSORIES

PART	DESCRIPTION	CODE	PART	DESCRIPTION	CODE
	Housing cover set.	FLXE 10-110		Ex d cable gland ISO 20	SPUD 20
	Cover gasket	FLXE 10-120		Ex d cable gland 3/4"NPT	SPUD 3/4"NPT
	LED module set	FLX 310 LED		Ex d plug ISO 20	SPCD 20
	Protective grid	FLX 310 LED		Ex d plug 3/4"NPT	SPCD 3/4"NPT
	Adapter Ex d e	ADP 10-160		Wall/ceiling mounting set	FLXE 20-170
				Pipe mounting set	FLXE 20-180

It is not possible to change a single LED source, but only replacement of the entire kit (LED module set. - FLX 310 LED)

## 11. INSPECTION, MAINTENANCE, REPAIR AND OVERHAUL

Inspections are carried out in accordance with IEC 60079-17:2007 general and special conditions of manufacturer and users Regulations and includes inspection of parts on which the explosion protection depends, especially:

- the housing, terminal chamber, glass protective framework, cable gland, plugs, protective glass and seal are without rupture and damage,
- the glands, plugs, terminals, screw and locking bolt on the housing cover are fastened with nominal torque

In to the parts for maintenance and repair belongs all the parts provided by the manufacturer and indicated in the list of spare parts. All other procedures have the character of repair. All the repairs are performed by the manufacturer or the manufacturer's authorized personal and the original parts have to be provided according to the product documentation, all in accordance with EN 60079-19:2011.

Overhaul and modifications are not allowed.

If repair or any other procedure are performed on the product by unauthorized person, all producer responsibility for the product and the warranty and the manufacturer's declaration of conformity becomes invalid.

## 12. RESPONSIBILITY AND AUTHORIZATION

This instruction is the basic information about the product. It is complementing with the corresponding national laws and regulations.

Production, use, certification and supervision are determined at the national level:

- a) Regulations concerning equipment and protective systems intended for use in potentially explosive atmospheres EU directive 94/9 EC (ATEX 94)
- b) Regulations on minimum requirements for safety and health protection of workers and technical inspection of facilities, equipment, installations and equipment in hazardous areas EU directive 1999/92/EC (ATEX 137).

The responsible person shall ensure their implementation at the working facility.

## 13. STORAGE AND TRANSPORT

Transportation and storage of the light fitting is only allowed in the original cardboard box.

## 14. MANUFACTURER'S WARRANTY

The manufacturer provides a Warranty on the product for a period of one year under the provisions of this User manual and the Law. This statement has the force of Warranty sheet.

## 15. MARKING

Explosion protected fluorescent lighting fitting, type FLX 310 LED . is labeled with:

- a warning labels with technical data on the housing

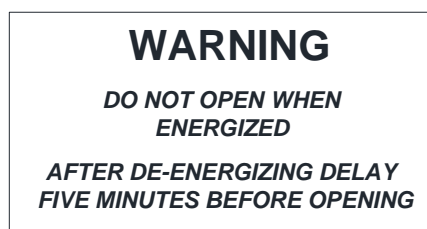

- Marking label with the technical data (outside):

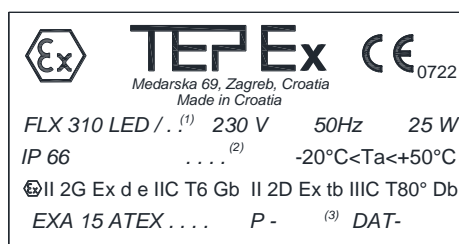

- Marking label with the technical data (inside):

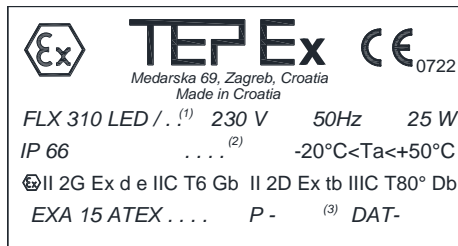

1) Entry type

2) Individual tests number