

SDM320M

Din Rail Smart Energy Meter for Single Phase Electrical Systems



USER MANUAL

2013 V1.0

Important Safety Information is contained in the Maintenance section. Familiarize yourself with this information before attempting installation or other procedures.

Symbols used in this document:



Risk of Danger: These instructions contain important safety information:
Read them before starting installation or servicing of the equipment



Caution: Risk of Electric Shock

1 Introduction

This document provides operating and installation instructions . The SDM320M measures and displays the characteristics of single phase two wires(1p2w) supplies, including voltage, frequency, current, power ,active energy, imported or exported. Energy is measured in terms of kWh.

SDM320M supports max. 100A direct connection,saves the cost and avoid the trouble to connect external CTs,giving the unit a cost-effective and easy operation.Built-in interfaces provides pulse and Rs485 Modbus RTU outputs.

1.1 Unit Characteristics

The Unit can measure and display:

- Line Frequency
- Currents, Current demands
- Power, maximum power demand and power factor
- Active energy imported and exported
- Reactive energy imported and exported

One pulse output indicates real-time energy measurement. An RS485 output allows remote monitoring from another display or a computer.

1.2 RS485 Serial – Modbus RTU

This uses an RS485 serial port with Modbus RTU protocol to provide a means of remotely monitoring and controlling the Unit.Set-up screens are provided for setting up the RS485 port.



1.2.1 RS485 communication

Bus type	RS485
Protocol	MODBUS RTU with 16 bit CRC
Baud rate	2400, 4800,9600(default),19200,38400
Address range	1-247 user settable
Bus Loading	64 meters per bus
Communication distance	1200m
Tariff number	2(default), 4(optional)
Time period	10
Clock accuracy	≤0.5S (every 24 hours)
Battery Voltage	3.6V DC, ≥1.2Ah

1.3 Pulse output

This provides one pulse outputs that clock up measured active energy. The constant of SDM320M for active energy is 1600imp/kWh.

2.Start Up Screens

	<p>The first screen lights up all display segments and can be used as a display check</p>
	<p>The second screen indicates the firmware installed in the unit and its build number.</p>
	<p>The interface perform a self-test and indicate the result if the test passes.</p>

After a short delay, the screen will display active energy measurement.

3.Parameters Screens

After display above three start up screens,the LCD will display and stay on the total kWh screen:

	<p>Total kWh</p>
---	------------------

After two successive pressing the  button,the total kWh screen will transfer to the following screens one by one.(each screen will last for 20seconds,and if there is no further press

on the  button,the screen will back to and stay on the Total kWh screen)

JIAXING EASTRON ELECTRONIC INSTRUMENTS CO.,LTD.

TEL:0086-573-83698881/83698882 FAX: 0086-573-83698883

Web: www.eastrongroup.com Email: sales@eastrongroup.com

Add: No.1369. Chengnan Road, Nanhu District, Jiaxing City, Zhejiang, China 314001.







	Import kWh
	Export kWh
	Total kWh of T1 period
	Total kWh of T2 period
	Active power Voltage Current
	Frequency Power factor

JIAXING EASTRON ELECTRONIC INSTRUMENTS CO.,LTD.

TEL:0086-573-83698881/83698882 FAX: 0086-573-83698883

Web: www.eastrongroup.com Email: sales@eastrongroup.com

Add: No.1369. Chengnan Road, Nanhu District, Jiaxing City, Zhejiang, China 314001.

	<p>Max. demand</p>
	<p>Max. Demand of T1 period</p>
	<p>Max. Demand of T2 period</p>
	<p>Address</p> <p>Default meter ID ranges from 001 to 247,default meter ID is 001.</p>
	<p>Baud rate</p> <p>The default baud is 9600,and 2400,4800,19200 and 38400 are optional.</p>
	<p>Date</p>

JIAXING EASTRON ELECTRONIC INSTRUMENTS CO.,LTD.

TEL:0086-573-83698881/83698882 FAX: 0086-573-83698883

Web: www.eastrongroup.com Email: sales@eastrongroup.com

Add: No.1369. Chengnan Road, Nanhu District, Jiaxing City, Zhejiang, China 314001.

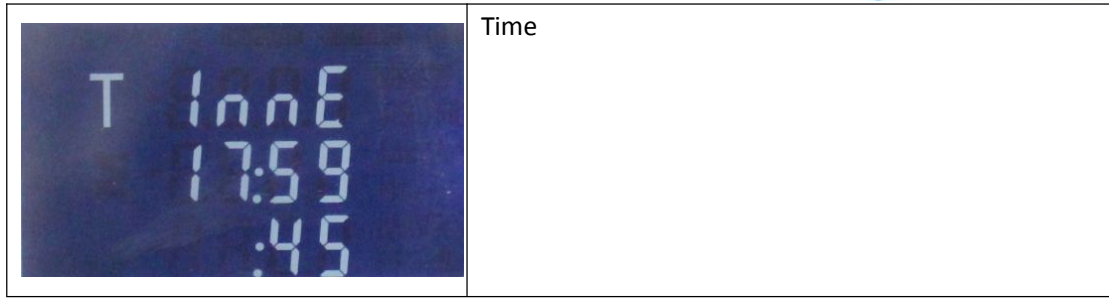

Time

4. Meter set-up

Before the set-up, it needs to set the meter into set-up model. The method is to long

press the  button for 5 seconds till the telephone symbol flash.



Notes: all the set-up need to be done via the Rs485 communication instead of operation on the meter directly

4.1 Set the date

For example

set the date as 2013-07-31 23:58:56

Step 1, modify the date as 2013-07-31

Send order: 01 10 F0 02 00 02 04 31 07 13 20 CRCH CRCL

Sept 2, modify the time as 23:58:56

Send order: 01 10 F0 00 00 02 04 56 58 23 01 CRCH CRCL

4.2 Set 2 tariffs and 10 periods

Register format

address	function code	date starts address	register number	date bit	DATA	CRC hi	CRC lo
XX	10H	0XF700	0X000F	(30)=1EH	XXXX	XX	XX

Notes: the basic date format is NNMMHH (HH is hour, from 0 to 23, MM is minute, from 0 to 59, NN is tariff number, from 1 to 2, all the parameters are BCD code)

JIAXING EASTRON ELECTRONIC INSTRUMENTS CO., LTD.

TEL: 0086-573-83698881/83698882 FAX: 0086-573-83698883

Web: www.eastrongroup.com Email: sales@eastrongroup.com

Add: No.1369, Chengnan Road, Nanhu District, Jiaxing City, Zhejiang, China 314001.

For example

Set 00:00-13:01,14:01-15:01,16:01-17:01,18:01-19:01,20:01-23:50 as **Tariff 1(T1)**

Set 13:01-14:01,15:01-16:01,17:01-18:01,19:01-20:01,23:50-00:00 as **Tariff 2(T2)**

Set order

01 10 F7 00 00 0F 1E 01 00 00 02 01 13 01 01 14 02 01 15 01 01 16 02 01 17 01 01 18
02 01 19 01 01 20 02 50 23

4.3 Set baud rate

Write date format

address	function code	date starts address	register number	date bit	DATA	CRC hi	CRC lo
adr	10H	0XF800	0X0001	2	XX XX	XX	XX

XX XX=0001H: 1200BPS

0002H: 2400BPS

0003H: 4800BPS

0004H: 9600BPS

0005H: 19200BPS

0006H: 38400BPS

Correct reply

date bit	function code	date starts address	register number	CRC16 lo	CRC16 hi
XXH	0X10	0XF800	0X0001	XX	XX

4.4 Set meter ID

Write date format

address	function code	date starts address	register number	date bit	DATA	CRC hi	CRC lo
Old adr	10H	0XF600	0X0001	2	New mete ID hex code	XX	XX

Correct reply

address	function code	date starts address	register number	CRC16 lo	CRC16 hi
XXH	0X10	0XF600	0X0001	XX	XX

5. Dimensions

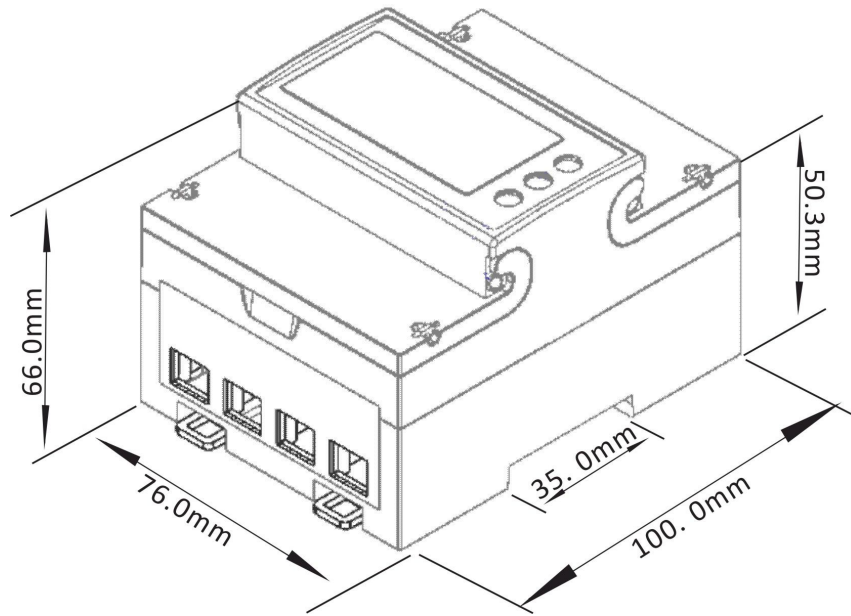

6. Wiring diagram

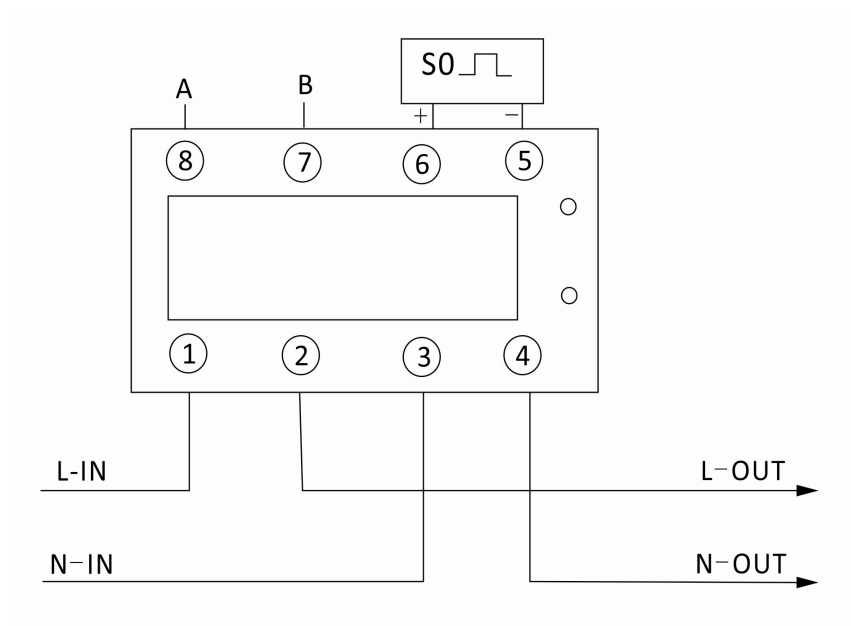

1/2 Phase line IN/OU 3/4 Neutral line IN/OUT
 6/7 Test pulse output contact 9/10 Rs485 communication

7.Register map

Address (hex)	Length (bytes)	Parameter Name	Access (R/W)	Data Format	Units
0x0000	4	Phase 1 line to neutral volts.	R	float	v
0x0006	4	Phase 1 current.	R	float	I
0x000c	4	Phase 1 power.	R	float	KW
0x0012	4	Phase 1 volt amps.	R	float	kva
0x001e	4	Phase 1 power factor	R	float	
0x0024	4	Phase 1 phase angle.	R	float	
0x0046	4	Frequency of voltage.	R	float	HZ
0x0201	12	Total Current Energy(Total、Rate1、Rate2)	R	float	KWh
0x0211	12	Total Last 1 month Energy (Total、 Rate1、 Rate2)	R	float	KWh
0x0221	12	Total Last 2 month Energy (Total、 Rate1、 Rate2)	R	float	KWh
0x0231	12	Total Last 3 month Energy (Total、 Rate1、 Rate2)	R	float	KWh
0x0241	12	Total Last 4 month Energy (Total、 Rate1、 Rate2)	R	float	KWh
0x0251	12	Total Last 5 month Energy (Total、 Rate1、 Rate2)	R	float	KWh
0x0261	12	Total Last 6 month Energy (Total、 Rate1、 Rate2)	R	float	KWh
0x0271	12	Total Last 7 month Energy (Total、 Rate1、 Rate2)	R	float	KWh
0x0281	12	Total Last 8 month Energy (Total、 Rate1、 Rate2)	R	float	KWh
0x0291	12	Total Last 9 month Energy	R	float	KWh

JIAXING EASTRON ELECTRONIC INSTRUMENTS CO.,LTD.

TEL:0086-573-83698881/83698882 FAX: 0086-573-83698883

Web: www.eastrongroup.com Email: sales@eastrongroup.com

Add: No.1369. Chengnan Road, Nanhu District, Jiaxing City, Zhejiang, China 314001.

		(Total、 Rate1、 Rate2)			
0x02A1	12	Total Last 10 month Energy (Total、 Rate1、 Rate2)	R	float	KWh
0x02B1	12	Total Last 11 month Energy (Total、 Rate1、 Rate2)	R	float	KWh
0x02B1	12	Total Last 12 month Energy (Total、 Rate1、 Rate2)	R	float	KWh
0XF000	4	Time	R/W	BCD	s--min-- hour-- 01. Date — Month — Year--20
0xF101	12	Current positive Energy (Total、 Rate1、 Rate2、			
0XF111	12	Last 1 month positive Energy (Total、 Rate1、 Rate2)	R	float	kWh
0XF121	12	Last 2 month positive Energy (Total、 Rate1、 Rate2)	R	float	kWh
0XF131	12	Last 3 month positive Energy (Total、 Rate1、 Rate2)	R	float	kWh
0XF141	12	Last 4 month positive Energy (Total、 Rate1、 Rate2)	R	float	kWh
0XF151	12	Last 5 month positive Energy (Total、 Rate1、 Rate2)	R	float	kWh
0XF161	12	Last 6 month positive Energy	R	float	kWh

JIAXING EASTRON ELECTRONIC INSTRUMENTS CO.,LTD.

TEL:0086-573-83698881/83698882 FAX: 0086-573-83698883

Web: www.eastrongroup.com Email: sales@eastrongroup.com

Add: No.1369. Chengnan Road, Nanhu District, Jiaxing City, Zhejiang, China 314001.

		(Total、Rate1、Rate2)			
OXF171	12	Last 7 month positive Energy (Total、Rate1、Rate2)	R	float	kWh
OXF181	12	Last 8 month positive Energy (Total、Rate1、Rate2)	R	float	kWh
OXF191	12	Last 9 month positive Energy (Total、Rate1、Rate2)	R	float	kWh
OXF1A1	12	Last 10 month positive Energy (Total、Rate1、Rate2)	R	float	kWh
OXF1B1	12	Last 11 month positive Energy (Total、Rate1、Rate2)	R	float	kWh
OXF1C1	12	Last 12 month positive Energy (Total、Rate1、Rate2)	R	float	kWh
OxF201		Current reverse Energy (Total、Rate1、Rate2)		float	
OXF211	12	Last 1 month reverse Energy (Total、Rate1、Rate2)	R	float	kWh
OXF221	12	Last 2 month reverse Energy (Total、Rate1、Rate2)	R	float	kWh
OXF231	12	Last 3 month reverse Energy (Total、Rate1、Rate2)	R	float	kWh
OXF241	12	Last 4 month reverse Energy (Total、Rate1、Rate2)	R	float	kWh

JIAXING EASTRON ELECTRONIC INSTRUMENTS CO.,LTD.

TEL:0086-573-83698881/83698882 FAX: 0086-573-83698883

Web: www.eastrongroup.com Email: sales@eastrongroup.com

Add: No.1369. Chengnan Road, Nanhu District, Jiaxing City, Zhejiang, China 314001.

OXF251	12	Last 5 month reverse Energy (Total、Rate1、Rate2)	R	float	kWh
OXF261	12	Last 6 month reverse Energy (Total、Rate1、Rate2)	R	float	kWh
OXF271	12	Last 7 month reverse Energy (Total、Rate1、Rate2)	R	float	kWh
OXF281	12	Last 8 month reverse Energy (Total、Rate1、Rate2)	R	float	kWh
OXF291	12	Last 9 month reverse Energy (Total、Rate1、Rate2)	R	float	kWh
OXF2A1	12	Last 10 month reverse Energy (Total、Rate1、Rate2)	R	float	kWh
OXF2B1	12	Last 11 month reverse Energy (Total、Rate1、Rate2)	R	float	kWh
OXF2C1	12	Last 12 month reverse Energy (Total、Rate1、Rate2)	R	float	kWh
OXF301	12	Current month positive max Demand (Total、Rate1、Rate2)	R	float	kW
OXF311	12	Last 1 month positive max Demand (Total、Rate1、Rate2)	R	float	kW
OXF321	12	Last 2 month positive max Demand (Total、Rate1、Rate2)	R	float	kW

JIAXING EASTRON ELECTRONIC INSTRUMENTS CO.,LTD.

TEL:0086-573-83698881/83698882 FAX: 0086-573-83698883

Web: www.eastrongroup.com Email: sales@eastrongroup.com

Add: No.1369. Chengnan Road, Nanhu District, Jiaxing City, Zhejiang, China 314001.

OXF331	12	Last 3 month positive max Demand (Total、Rate1、Rate2)	R	float	kW
OXF341	12	Last 4 month positive max Demand (Total、Rate1、Rate2)	R	float	kW
OXF351	12	Last 5 month positive max Demand (Total、Rate1、Rate2)	R	float	kW
OXF361	12	Last 6 month positive max Demand (Total、Rate1、Rate2)	R	float	kW
OXF371	12	Last 7 month positive max Demand (Total、Rate1、Rate2)	R	float	kW
OXF381	12	Last 8 month positive max Demand (Total、Rate1、Rate2)	R	float	kW
OXF391	12	Last 9 month positive max Demand (Total、Rate1、Rate2)	R	float	kW
OXF3A1	12	Last 10 month positive max Demand (Total、Rate1、Rate2)	R	float	kW
OXF3B1	12	Last 11 month positive max Demand (Total、Rate1、Rate2)	R	float	kW
OXF3C1	12	Last 12 month positive max Demand (Total、Rate1、Rate2)	R	float	kW
OXF401	12	Current month reverse max Demand (Total、Rate1、Rate2)	R	float	kW

JIAXING EASTRON ELECTRONIC INSTRUMENTS CO.,LTD.

TEL:0086-573-83698881/83698882 FAX: 0086-573-83698883

Web: www.eastrongroup.com Email: sales@eastrongroup.com

Add: No.1369. Chengnan Road, Nanhu District, Jiaxing City, Zhejiang, China 314001.

OXF411	12	Last 1 month reverse max Demand (Total、Rate1、Rate2)	R	float	kW
OXF421	12	Last 2 month reverse max Demand (Total、Rate1、Rate2)	R	float	kW
OXF431	12	Last 3 month reverse max Demand (Total、Rate1、Rate2)	R	float	kW
OXF441	12	Last 4 month reverse max Demand (Total、Rate1、Rate2)	R	float	kW
OXF451	12	Last 5 month reverse max Demand (Total、Rate1、Rate2)	R	float	kW
OXF461	12	Last 6 month reverse max Demand (Total、Rate1、Rate2)	R	float	kW
OXF471	12	Last 7 month reverse max Demand (Total、Rate1、Rate20)	R	float	kW
OXF481	12	Last 8 month reverse max Demand (Total、Rate1、Rate2)	R	float	kW
OXF491	12	Last 9 month reverse max Demand (Total、Rate1、Rate2)	R	float	kW
OXF4A1	12	Last 10 month reverse max Demand (Total、Rate1、Rate2)	R	float	kW
OXF4B1	12	Last 11 month reverse max Demand (Total、Rate1、Rate2)	R	float	kW

JIAXING EASTRON ELECTRONIC INSTRUMENTS CO.,LTD.

TEL:0086-573-83698881/83698882 FAX: 0086-573-83698883

Web: www.eastrongroup.com Email: sales@eastrongroup.com

Add: No.1369. Chengnan Road, Nanhu District, Jiaxing City, Zhejiang, China 314001.

OXF4C1	12	Last 12 month reverse max Demand (Total、Rate1、Rate2)	R	float	kW
OXF500	4	Demand interval 、 slide time 、 Display time 、 LED time	R/W	BCD	min-min-s-min Display time=0 do not display in turns LED time=0 alway on
OXF511	12	Time of max. demand in current month (Total、Rate1、Rate2)	R	BCD	MM DD.HH:mm
OXF521	12	Time of max. demand in Last 1month (Total、Rate1、Rate2)	R	BCD	MM DD.HH:mm
OXF531	12	Time of max. demand in Last 2month (Total、Rate1、Rate2)	R	BCD	MM DD.HH:mm
OXF541	12	Time of max. demand in Last 3month (Total、Rate1、Rate2)	R	BCD	MM DD.HH:mm
OXF551	12	Time of max. demand in Last 4month (Total、Rate1、Rate2)	R	BCD	MM DD.HH:mm
OXF561	12	Time of max. demand in Last 5month (Total、Rate1、Rate2)	R	BCD	MM DD.HH:mm
OXF571	12	Time of max. demand in Last 6month (Total、Rate1、Rate2)	R	BCD	MM DD.HH:mm

JIAXING EASTRON ELECTRONIC INSTRUMENTS CO.,LTD.

TEL:0086-573-83698881/83698882 FAX: 0086-573-83698883

Web: www.eastrongroup.com Email: sales@eastrongroup.com

Add: No.1369. Chengnan Road, Nanhu District, Jiaxing City, Zhejiang, China 314001.

OXF581	12	Time of max. demand in Last 7month (Total、Rate1、Rate2)	R	BCD	MM DD.HH: mm
OXF591	12	Time of max. demand in Last 8month (Total、Rate1、Rate2)	R	BCD	MM DD.HH: mm
OXF5A1	12	Time of max. demand in Last 9month (Total、Rate1、Rate2)	R	BCD	MM DD.HH: mm
OXF5B1	12	Time of max. demand in Last 10month (Total、Rate1、Rate2)	R	BCD	MM DD.HH: mm
OXF5C1	12	Time of max. demand in Last 11month (Total、Rate1、Rate2)	R	BCD	MM DD.HH: mm
OXF5D1	12	Time of max. demand in Last 12month (Total、Rate1、Rate2)	R	BCD	MM DD.HH: mm
OXF600	2	Meter number	R/W	Hex	
OXF700	30	Tariff	R/W	BCD	Tariff number- Min- Hour
OXF800	2	Baud rate	W	Hex	0001H: 1200bps 0002H: 2400bps 0003H: 4800bps 0004H: 9600bps

JIAXING EASTRON ELECTRONIC INSTRUMENTS CO.,LTD.

TEL:0086-573-83698881/83698882 FAX: 0086-573-83698883

Web: www.eastrongroup.com Email: sales@eastrongroup.com

Add: No.1369. Chengnan Road, Nanhu District, Jiaxing City, Zhejiang, China 314001.

					00 05 : 19200 00 06 : 38400
--	--	--	--	--	--------------------------------------

JIAXING EASTRON ELECTRONIC INSTRUMENTS CO.,LTD.

TEL:0086-573-83698881/83698882 FAX: 0086-573-83698883

Web: www.eastrongroup.com Email: sales@eastrongroup.com

Add: No.1369. Chengnan Road, Nanhu District, Jiaxing City, Zhejiang, China 314001.