



# ROYALKING

*Wellness, auch für Ihr Portemonnaie*



## **Beachside** FAMILY

**Infrared sauna**

**USER'S MANUAL**

**Anschlusswerte siehe Seite 9 von 9**

# Beachside FAMILY

## Infrared sauna

**Sizes: 1980 x 1980 x 2060 mm**

- Color therapy lighting
- 2 person bamboo infrared sauna
- Ground glass door
- Ventilator
- Computer control
- 7 piece redlight heater
- Front infra wires 2 pieces (500W)
- Rear infra wires 4 pieces (300W)
- Leg infra 1 piece (500W)
- 15 minutes start-up time

The informations in the users manual are for valuation only. Wellis Hungary Ltd. doesn't take the responsibility for any typographic errors.

## 710B controller

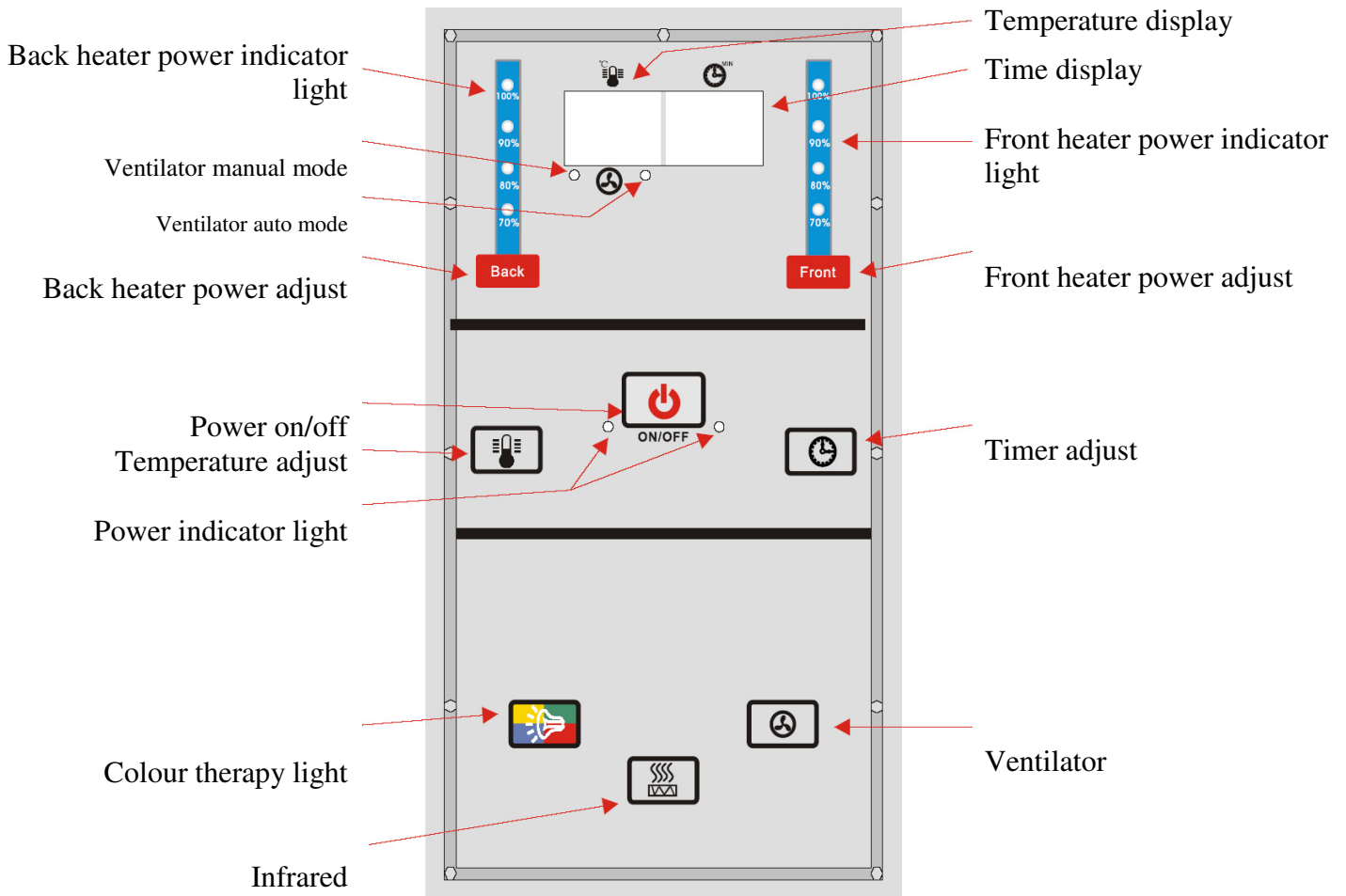

### I. Power on/off:

Plug in the sauna. Power indicator light flashes, press „” to start mode. It indicates colour therapy and ventilator automatic mode and the inside temperature can be seen. When you press it once again to turn down all the functions, power indicator light flashes.

### II. Infrared function

Press „” to start the infrared function. Press „**Back**” or „**Front**” to adjust heater power. The heater value is 100%, when you turn it on. By pressing it each time the value decreases by 10%, and this change can be seen on the indicator light.

### III. Time setting

During the use of infrared mode, by pressing „” you can adjust heater working time. The range of working time is 5-30 minutes. Automatic working time is 30 minutes. On the display the left over time of the heater is to be seen, as a countdown..

### IV. Temperature setting

During the use of infrared mode, by pressing „” you can set heater working temperature. The range of working is 35-60°C. Automatic heating is up to 45°C. When the temperature of the setting value is reached the infrared power automatically turns down to

70%. When the temperature decreases by 2°C than the setting value, infrared automatically recover the power. The change of temperature can be followed on the display.

#### V. Ventilator function

When the setting temperature value has been reached the ventilation automatically starts. The ventilator automatic mode indicator light turns on. By pressing „” manual mode indicator can be turned on.

#### VI. Colour therapy

By pressing „” colour therapy indicates. Among the following colours can be chosen: White, green, yellow, blue, red. The automatic colour: white.

#### Remarks:

- I. User must install short circuit protector and circuit breaker.
- II. Make sure that earth wire is connected to the ground.
- III. When display shows E1 do not turn on heater function, instead make sure to solve temperature detector problem.
  - a. Temperature detector open circuit, flashing display shows E1.
  - b. Temperature has reached maximum. (60°C)
    1. Avoid temperature detector over 60°C in any case
    2. If the temperature detector resistance reduces the detector is incorrect
    3. When temperature unchanges, the temperature detector resistance becomes high, detector is incorrect.

For safety, temperature detector must be replaced as it occurs in 2 and 3.

IV. Electric box has strong electricity. Opening is FORBIDDEN! Only a specialist can help!!

V. See the introduction guide before using..

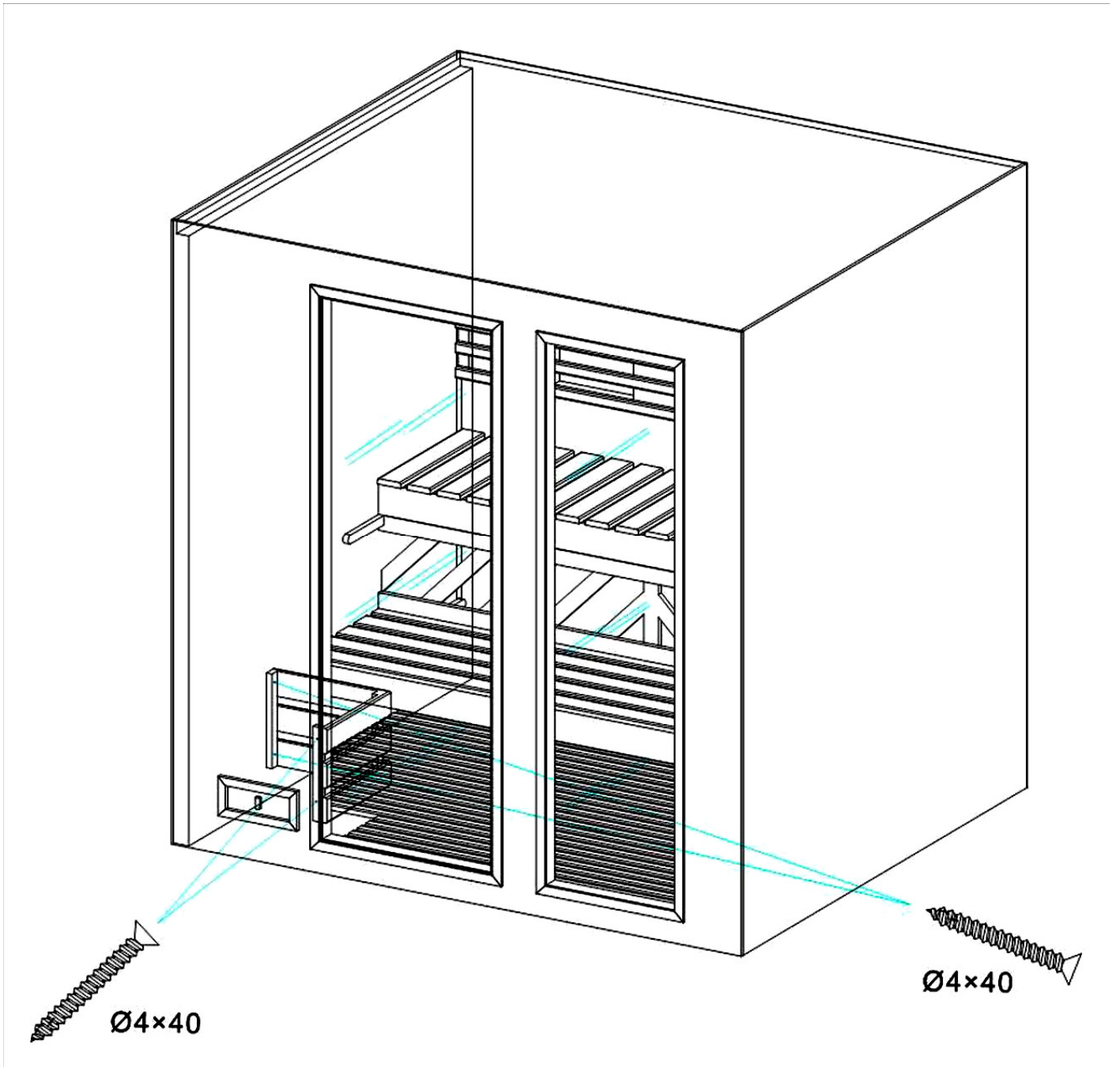

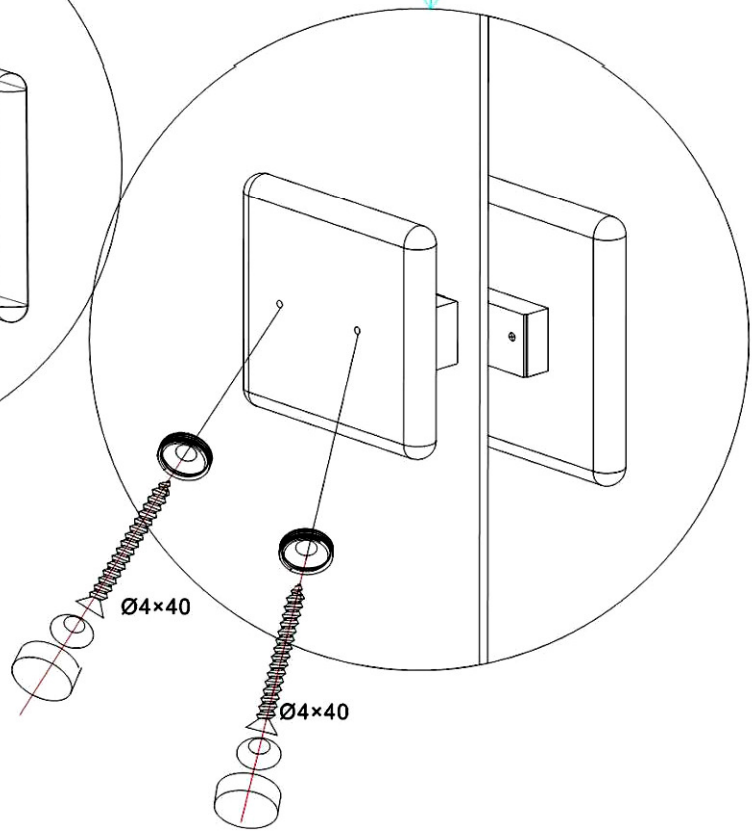
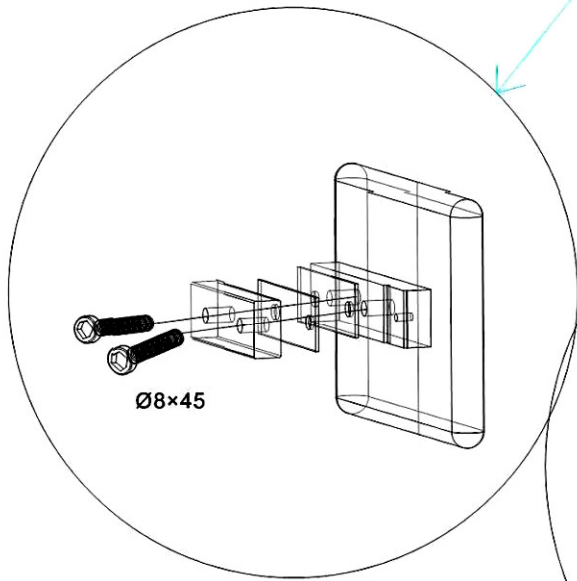
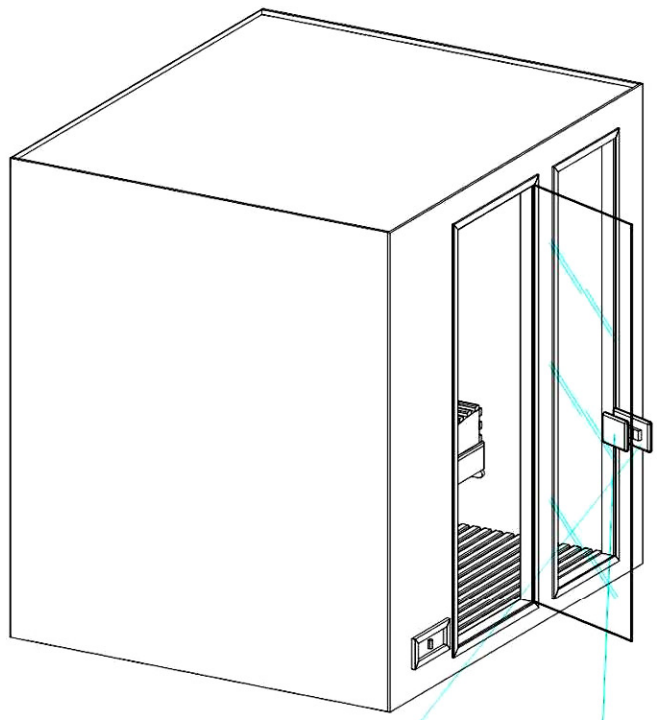

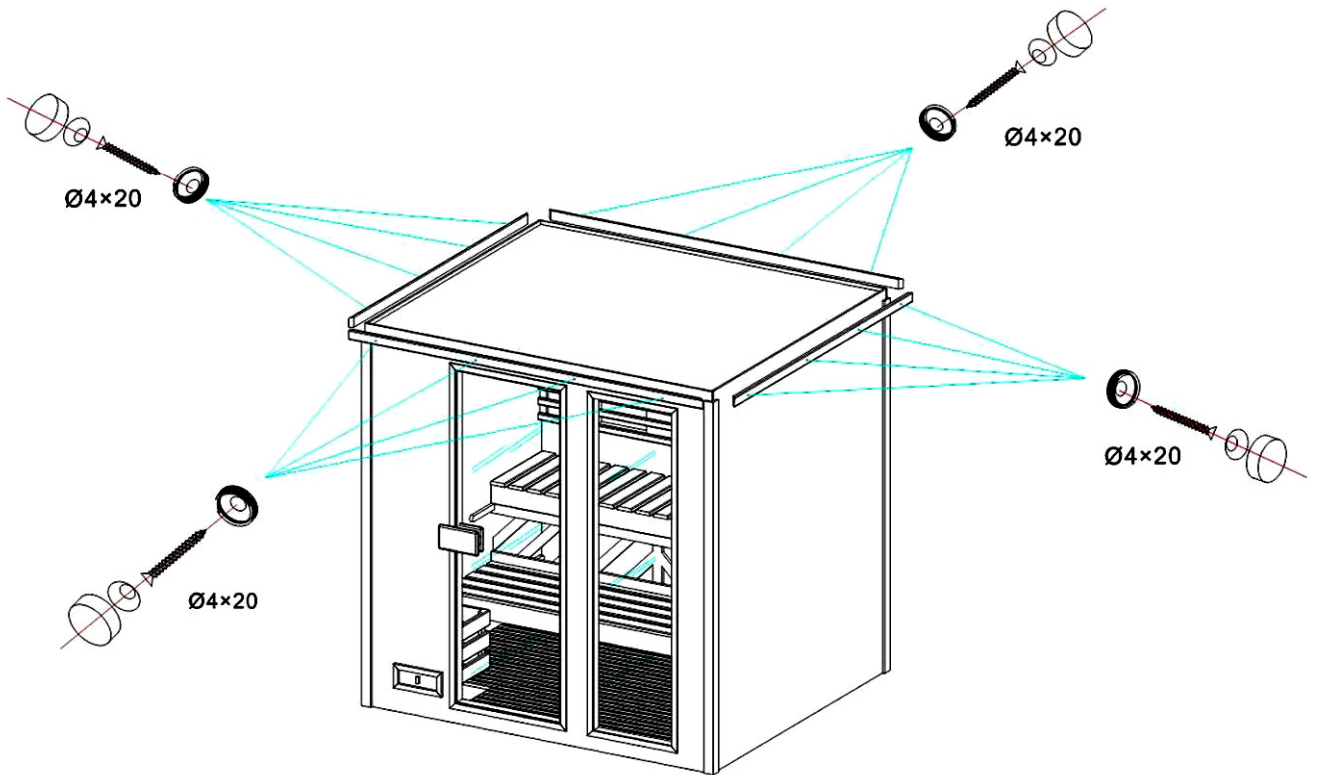
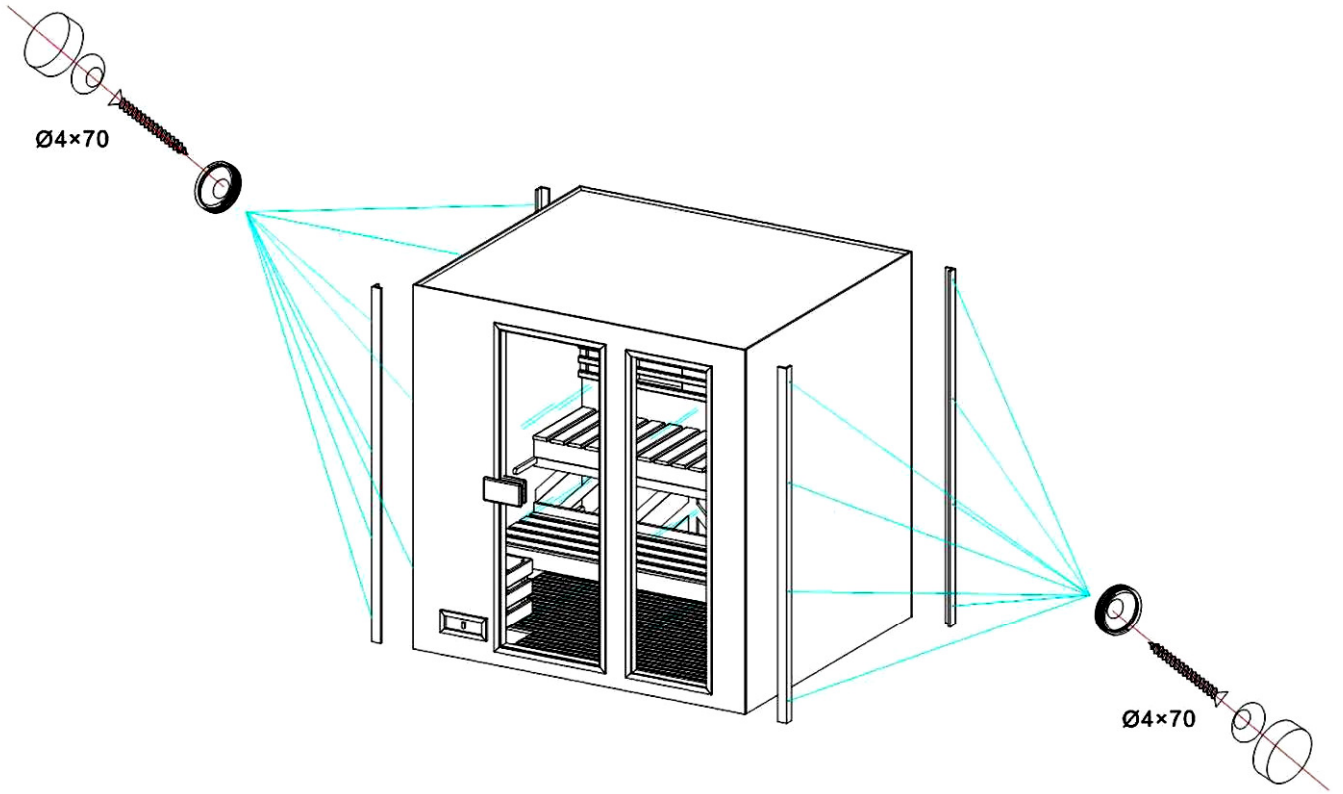

Power switch (European)

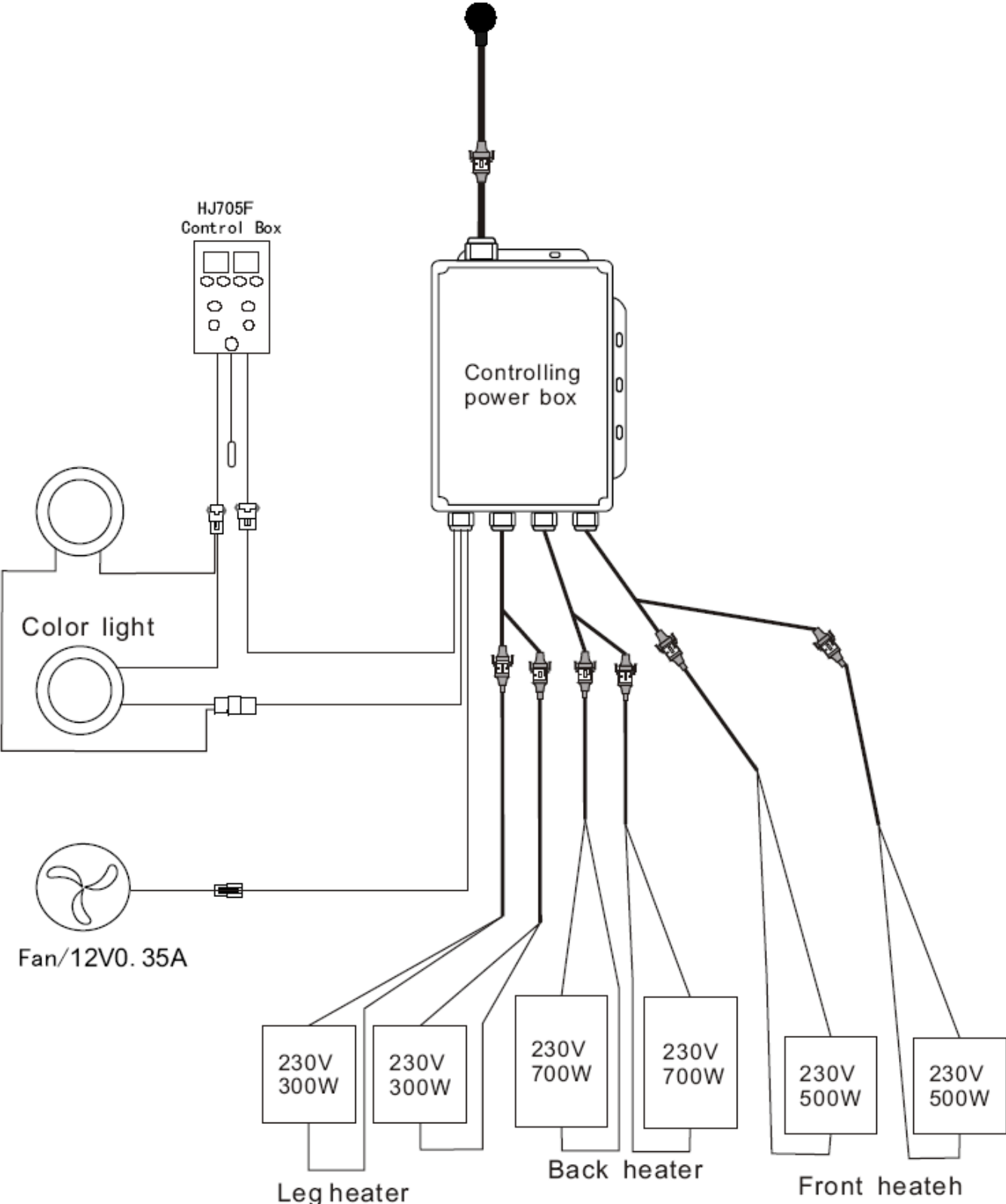



**Infrarot-Sauna Anschlusswert 3.0 KW**  
**Finn-Sauna Anschlusswert 6.0 KW**  
**Elektronik Anschlusswert 0.2 KW**

**Gesamt Anschlusswert 9.2 KW / 400V /**  
**3 Phasen à 16 Amp. abgesichert über FI**

**Stromanschluss: 2 Meter Kabel, (1 Meter von links, 2 Meter ab Fussboden)**  
**Bitte Aufputz-Verteilerdose bereit stellen**

---

# **ROYALKING AG**

Ringstrasse 15 / Stelz  
CH 9500 Wil

T 071 925 40 40

F 071 925 25 41

E-Mail: [info@royalking.ch](mailto:info@royalking.ch)

Homepage: [www.royalking.ch](http://www.royalking.ch)