



Class **HD**™

# Roth™



# ROTH SUB ZERO

TV Soundbar

# ROTH SUB ZERO

## Contents

Key features .....	3
Important safety instructions .....	4-5
Supplied parts and accessories .....	6
Getting started .....	7
Wall mounting .....	8
Setup instructions (hookup guide) .....	9
Controls and functions .....	10-11
Hookup diagram .....	13
Specifications .....	14



## Thank you...

For taking the Roth AV Sub Zero Soundbar home.

We've designed the Sub Zero to look discreet and elegant and, utilising the very best available amplification and driver technology, sound great too. Stand by... your TV is about to sound fabulous.

Turn It Up.

## Key Features

Congratulations on your purchase of the Sub Zero Soundbar.

The Sub Zero is designed to provide higher quality sound from your flat panel television. It is designed to mount either on the desk top with the supplied table stands or on the wall with the supplied wall mount kit.

You will enjoy outstanding audio performance due to use of patented Class HD™ amplifiers and a novel surround processor called FX (Fractal Expansion). The Sub Zero is best used with TV's from 32" up to 42" where its compact size and styling will unobtrusively complement your TV and the room décor.

### Advanced Technologies in the Sub Zero

#### Wider Sound Stage: Vector Firing (VF) Side Drivers

The Vector Firing Side Drivers(4) enhance both stereo and FX surround modes. The sweet spot for listening is wider and the surround effects are more dramatic as a result of the VF side driver design and Fractal Expansion processing.

#### High Efficiency Amplifier Technology: ClassHD

The Sub Zero employs a new class of patented audio amplifier called Class HD™. The Class HD™ amplifier is more efficient at normal listening levels than conventional amplifiers and even more efficient than Class D digital amplifiers. This new technology allows for a very compact audio system design with the performance of a much larger audio system. Another advantage to the Class HD™ amplifier is that there is no need for bulky external power adapters.

#### State-of-the-Art Processing: Fractal Expansion (FX)

Experience a convincing surround sound presentation from the 10-speaker Sub Zero. Fractal Expansion is an advanced audio processing technology that converts the 2 channel stereo into a wide sound stage with virtual center and surround images that will amaze and thrill you. This advanced processing preserves the tonal accuracy of the original sound source to create rich sound. You can enjoy your favorite music using Fractal Expansion or select the high fidelity stereo mode.

# ROTH SUB ZERO

## Important Safety Instructions

### SAFETY POINTS YOU SHOULD KNOW ABOUT YOUR SUB ZERO SOUNDBAR.

To help you operate these products properly, this section illustrates safety tips which will be of benefit to you. Please read it carefully and apply the knowledge you obtain from it to the proper operation of your Roth AV Sub Zero Soundbar.

### READ BEFORE OPERATING EQUIPMENT

Follow all warnings and instructions marked on this Sub Zero Soundbar Audio System.

1. Read these instructions.
2. Keep these instructions.
3. Heed all warnings.
4. Follow all instructions.
5. Do not use this apparatus near water.
6. Clean only with a dry cloth.
7. Do not block any ventilation openings. Install in accordance with the manufacturer's instructions.
8. Do not install near any heat sources such as radiators, heat registers, stoves, or other apparatus (including amplifiers) that produce heat.
9. Do not defeat the safety purpose of the polarized or grounding type plug. A polarized plug has two blades with one wider than the other. A grounding type plug has two blades and a third grounding prong. The wide blade or the third prong are provided for your safety. If the provided plug does not fit into your outlet, consult an electrician for replacement of the obsolete outlet.
10. Protect the power cord from being walked on or pinched particularly at plugs, convenience receptacles, and the point where they exit from the apparatus.
11. Only use the attachments/accessories specified by the manufacturer.
12. Use only with the cart, stand, tripod, bracket, or table specified by the manufacturer, or sold with the apparatus. When a cart is used, use caution when moving the cart/apparatus combination to avoid injury from tip-over.
13. Unplug this apparatus during lightning storms or when unused for long periods of time.
14. Refer all servicing to qualified service personnel. Servicing is required when the apparatus has been damaged in any way, such as power-supply cord or plug is damaged, liquid has been spilled or objects have fallen into the apparatus, the apparatus has been exposed to rain or moisture, does not operate normally, or has been dropped.
15. The system is designed to comply with the recommended safety standards for tilt and stability. Do not apply excessive pulling force to the front, or top, of the cabinet which could cause the product to overturn resulting in product damage and/or personal injury.
16. Follow instructions for wall, shelf or ceiling mounting as recommended by the manufacturer.



### Power Source

This audio system is designed to operate on 230 volts 50 Hz, AC current. Insert the power cords into a 230 volt 50 Hz outlet. The main plugs are used as the disconnect device and shall remain readily accessible.

To prevent electric shock, do not use the audio system's cords with an extension cord, receptacle, or other outlet unless the blades and ground terminal can be fully inserted to prevent blade exposure.

Never connect the audio system to 60 Hz, direct current, or anything other than the specified voltage.

### Disposal



Proper disposal of this product. This label indicates that, in the EU, electronic devices cannot be disposed of with regular household waste. Please use the return or collections systems of your municipality or contact the seller where you purchased this product



Please dispose of batteries environmentally friendly. Do not dispose of batteries with regular household waste. Please use the return or collections systems of your municipality or contact the seller where you purchased this product.

### Caution

Never remove the back covers of the audio system as this can expose you to very high voltages and other hazards. If the system does not operate properly, unplug the audio system and call your authorized dealer or service center. Adjust only those controls that are covered in the instructions.

### Warning

- To reduce the risk of fire or electric shock, do not expose this apparatus to rain or moisture
- The system should not be exposed to dripping or splashing and objects filled with liquids, such as vases, should not be placed on the system.
- This apparatus shall be connected to a mains socket outlet with a protective earthing connection.

### Electrical Information

This system is fitted with a BS1363/A 13 amp plug. If it is not suitable for your supply sockets it must be removed and replaced with an appropriate plug. If the plug becomes damaged and/or needs to be replaced please follow the wiring instructions below. The plug removed must be disposed of immediately. It must not be plugged into a supply socket as this will be an electrical hazard. If the fuse needs to be replaced it must be of the same rating and ASTA approved to BS1362. If the plug is changed, a fuse of the appropriate rating must be fitted in the plug, adapter or at the distribution board. If the fuse in a moulded plug is replaced, the fuse cover must be refitted before the appliance can be used.

### Wiring Instructions

The supply cable will be either 2-core or 3-core. Follow the appropriate wiring instructions given below. In both cases ensure that the outer sheath of the cable is firmly held by the cable clamp.



### Precautions

- Do not place the system on uneven surfaces or near the edge of a cabinet.
- Unplug immediately if any foreign materials falls into the system, or if the system falls down.
- Do not open the system's cabinet.
- Avoid direct sunlight, dust, high humidity and smoky locations.
- Remember to unplug the power cord from the AC outlet before cleaning. Do not use liquid cleaners or aerosol cleaners to clean the system.
- Do not place the system near water, such as a bathtub, shower rooms, kitchen sink, laundry tub or swimming pool.
- Do not place the system in confined spaces or inside a box when the system is operating.
- Make sure to unplug the system when not in use for a long period of time (days).

### Notice for Remote Control

- Avoid dropping the unit.
- Avoid liquids on it.
- Avoid aerosol cleaners.

#### 2- Core plug

 This symbol indicates that this 2-core appliance is Class II and does not require an earth connection.

The wire coloured blue must be connected to the terminal marked with the letter N or coloured black. The wire coloured brown must be connected to the terminal marked with the letter L or coloured red.

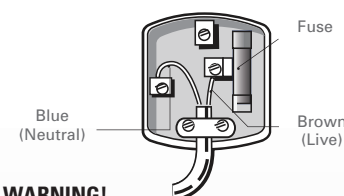

#### WARNING!

Do not connect either wire to the earth terminal. 

#### 3- Core plug

The wire coloured green and yellow must be connected to the terminal marked with the letter E, or by the earth symbol  or coloured green or green and yellow.

The wire coloured blue must be connected to the terminal marked with the letter N or coloured black. The wire coloured brown must be connected to the terminal marked with the letter L or coloured red.

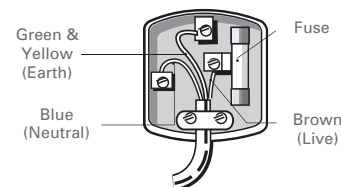

**WARNING!** This appliance must be earthed. 



The exclamation point within an equilateral triangle, is intended to alert the user to the presence of important operating and maintenance (servicing) instructions in the literature accompanying the appliance.



The lightning flash with arrowhead symbol, within an equilateral triangle, is intended to alert the user to the presence of uninsulated "dangerous voltage" within the product's enclosure that may be of a sufficient magnitude to constitute a risk of electric shock to a person.

# ROTH SUB ZERO

## What's In The Box

### Sub Zero Soundbar



### Sub Zero Remote Control



### Sub Zero Table Stands



### Accessories

- RCA Hookup Cable
- 3.5mm Stereo Cable
- Wall Mounting Kit
- User Manual

## Battery Installation

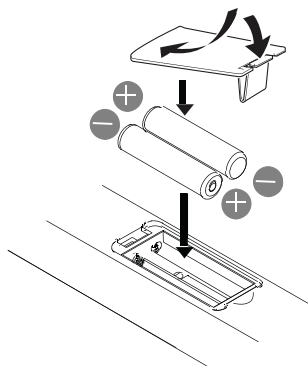

### Caution

- Do not insert battery with '+' and '-' polarities reversed as this may cause the battery to swell or rupture resulting in leakage.
- Remove the battery if the remote control is not going to be used for an extended period of time.
- Do not put the battery in the general household rubbish. Dispose of the battery according to applicable laws.

## Getting Started

### Determine how you want to set up your Sub Zero Soundbar.

The following figures show 2 typical installation styles. One is the Table Top style and the other is the Wall Mount style.



#### Table Top Style

You can mount the Sub Zero on a cabinet that is properly designed for a TV. Please install the supplied stands by following the instructions that are shown on the bottom of this page.

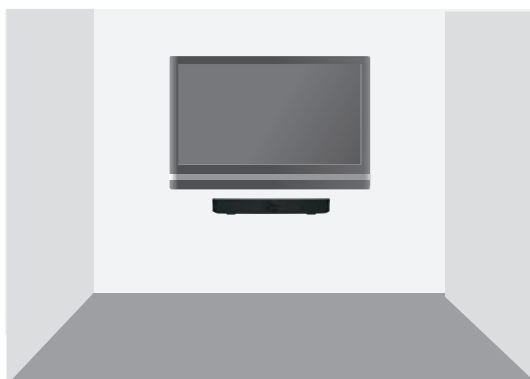

#### Wall Mount Style

You can mount the Sub Zero on a wall by using the supplied hardware kit. The input jacks and power cord are designed to allow a flush mount. Please follow the instructions that are shown on page 8 of this Owners Guide.

### Think About Location

Select an area where sunlight will not fall directly on the products. Also, be sure that the location selected allows a free flow of air to and from the products. In order to prevent an internal temperature increase, maintain the following space requirements.

#### Sub Zero

**Top / Bottom / Back:** No clearance required - can be flush mounted.

**Left / Right:** At least 6" (150 mm) clearance required.

**Front:** Open between the Sub Zero and the listeners.

### Installing the stands

In order to place the Sub Zero on the cabinet or a shelf, you need to install the supplied 2 (two) stands by using the following installation guide. Please make sure that the cabinet or shelf is strong enough and well secured.



#### Step 1

Insert the top tab of the stand into the hole provided for the stand in the back of the Sub Zero

#### Step 2

Make sure that the top tab is fully inserted into the hole.

#### Step 3

Swing down the stand all the way until the stand hits the Soundbar so that the base of the stand will be underneath of the bottom of the Sub Zero. Then push up the stand to fit the Sub Zero.



#### Step 4

Make sure that the both stands are installed as shown in the above picture.

# ROTH SUB ZERO

## Wall Mounting

### Determine how you want to set up your Sub Zero Soundbar.

The Sub Zero Soundbar comes with a wall mounting kit to be used with a wall mounted TV. The input jacks and power cord are designed to allow a flush mount where the Soundbar extends only 89 mm from the wall. Also, the Soundbar is provided with an extra-long power cord so the user may hide the AC line by using a wall track that could be painted to match the wall.

### Follow these steps to mount the Sub Zero Soundbar on a wall:

1. Measure the width of the TV – the Sub Zero should be mounted so it is centered with the TV. Divide the TV width measurement by 2 - that will be the centerline distance from the edges of the TV.
2. If the Sub Zero is to be mounted below the TV, measure from the TV edge to the centerline distance on the open wall below the TV.  
Mark the distance with a pencil 1-1/2" (38 mm) or more below the bottom of the TV.
3. Make a pencil mark 10-7/16" (265 mm) on each side of the centerline. Make sure the mark is the same distance down from the TV on each side.
4. Make another mark 25/32" (20 mm) directly below the 1st mark on each side.
5. Drill a 1/4" hole in the wall at each of the four pencil marks.
6. Hammer the 4 wall mount anchors into the holes - the anchors should be flush with the wall.
7. Now, using a Philips screwdriver, screw the wall brackets in place with the screws going into the anchors.
8. Tilting the bottom of the Sub Zero slightly away from the wall, guide the brackets into the matching holes on the back of the Sub Zero. The Sub Zero is now securely wall mounted.

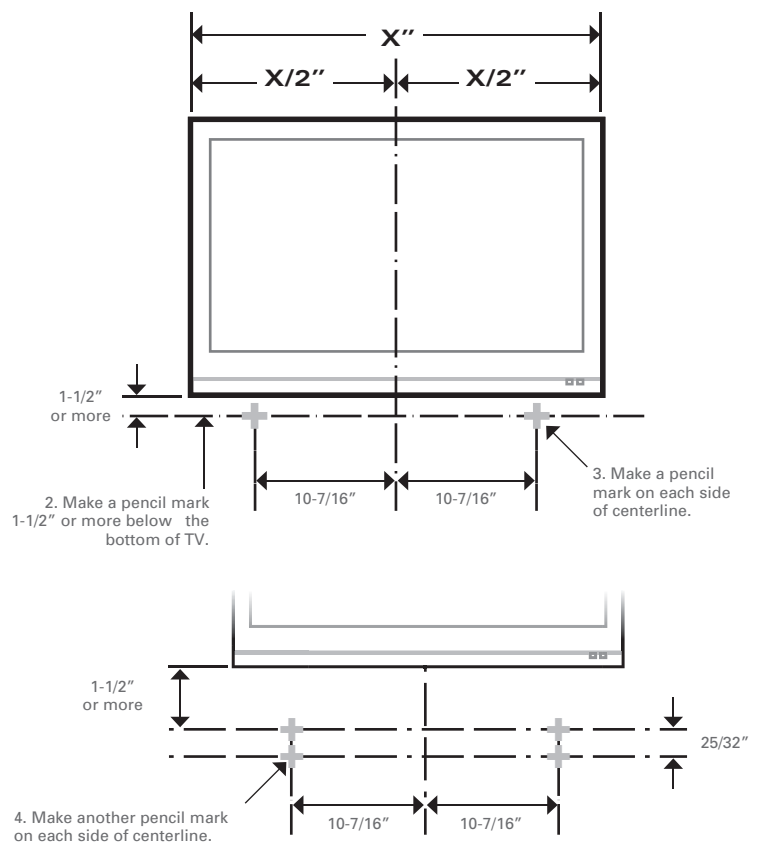

### NOTES

The supplied mounting kit can be used for typical drywall construction. Mounting to wood, concrete, brick or other types of wall construction will require different hardware. Roth AV recommends seeking professional assistance for such installations. The instructions on this page and the supplied wall mount kit are only for the vertical wall mount. Professional assistance is required for other mounting or installation orientations (e.g., horizontal, tilted).



## Setup Instructions

1. Unpack all the parts noted on page 6.
2. If your TV has a headphone output, plug the supplied 3.5 mm mini stereo cable into the headphone jack output of your TV and the other end goes to the Input 3 jack on the back of your Sub Zero (shown below). This method will disable your TV's sound system and allow direct control of the Sub Zero audio with your TV's remote control.

### 3.5 mm Stereo Cable



3. If your TV does not have a headphone output and you are using a set top box, plug one end of the included RCA cable into the audio outputs of your set top box and the other end into Input 2 on the back of your Sub Zero. The Sub Zero remote control and the control buttons on the front panel of the Sub Zero will always function no matter what the audio input source is.

[Note] Some TV's do not have a headphone output but do have Audio outputs with RCA jacks. You can connect them to Input 2 by using the RCA cable. This will also work fine except that the Sub Zero volume must now be adjusted using the Sub Zero remote.

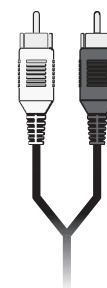
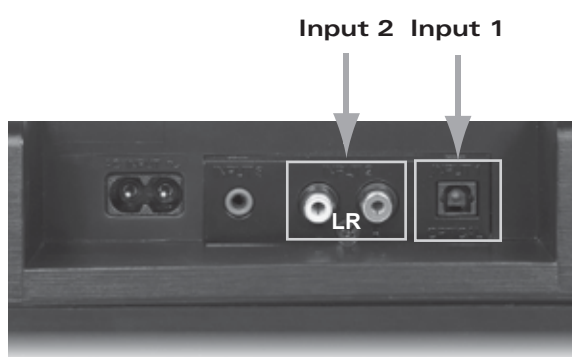

4. Input 2 can be attached to Blu-ray, DVD or CD players or to personal music players. Input 1 is an Optical Input. If your TV does not have a headphone output, use this input to connect with the set-top-box by using an Optical Input cable (not included).
5. Install the table stands and plug the Sub Zero power cord into the wall.

# ROTH SUB ZERO

## Controls and Functions

The controls and functions of the Sub Zero and the Remote Control are explained below.

### Front Panel Controls / LED Indicators

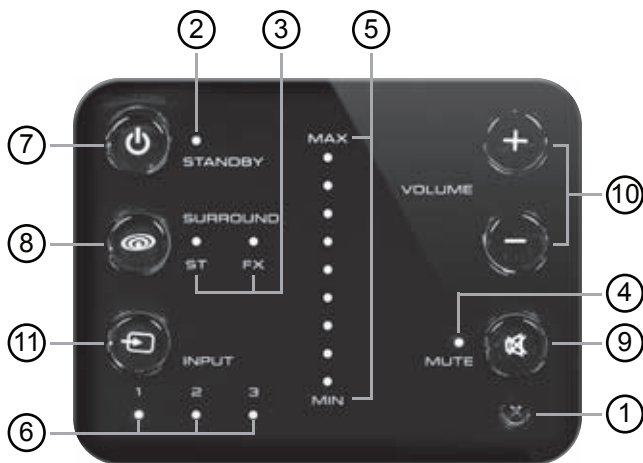

### Rear Panel of Soundbar

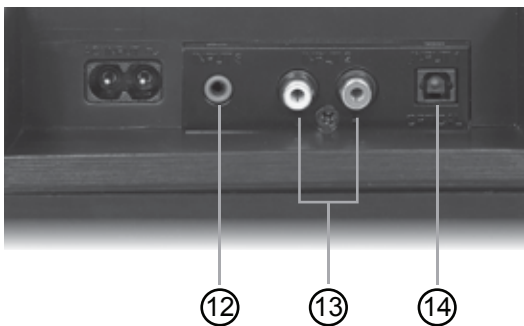

#### 1. REMOTE CONTROL Sensor

Point your remote control at this area when you use the remote control.

#### 2. POWER ON Indicator

Plug the power cord into the AC outlet. The Sub Zero goes to the standby mode, and this indicator is also turned off. Press the POWER button to turn the Sub Zero on, this indicator will illuminate to indicate the Sub Zero is on. This indicator will remain on as long as an input signal is active. If the input becomes inactive the Sub Zero will change to standby mode to conserve power and this indicator will turn off.

#### 3. FX SURROUND (FX) / STEREO (ST) Indicator

The FX indicator lights up when FX Surround is selected. The ST indicator lights up when Stereo Mode is selected. This indicator will turn off after about 3 seconds from selecting the surround setting.

#### 4. MUTE ON Indicator

This indicator lights up when mute is on. This indicator will turn off after about 3 seconds from turning mute on.

#### 5. MAIN VOLUME Level Indicator

This indicator shows the level of the main volume or Soundbar volume when you use the MAIN VOLUME Button respectively. The indicator will turn off after about 3 seconds from adjusting the volume.

#### 6. INPUT SELECTION Indicator

The 1, 2, or 3 indicator lights up when INPUT 1, INPUT 2, or INPUT 3 is selected, respectively, by pressing the INPUT Button. The indicator will turn off after about 3 seconds from selecting the input.

#### 7. POWER Button

Plug the power cord into the AC outlet. The Sub Zero goes to the standby mode. Press this button to turn the Sub Zero on. The POWER indicator will illuminate to indicate the Sub Zero is on. The Sub Zero will remain on as long as an input signal is active. If the input becomes inactive the Sub Zero will change to standby mode to conserve power. To completely turn off the Sub Zero, press this button again.

### 8. SURROUND Button

This button is used to select either the FX SURROUND mode or the STEREO mode.

### 9. MUTE Button

Press this button when you want to activate the audio mute. Press it again to deactivate the mute function. Pressing the VOLUME buttons will also deactivate the mute function.

### 10. MAIN VOLUME Buttons

Press the + or - button to adjust the main volume up or down respectively.

### 11. INPUT SELECTOR Button

Press this button to select INPUT 1, INPUT 2, or INPUT 3.

### 12. INPUT 3

Connection type - 3.5mm stereo cable. If your TV has a headphone output, this is a primary input to use by using the supplied 3.5 mm mini stereo cable.

### 13. INPUT 2

Connection Type - RCA. Use this input to connect with your external devices (Blu-ray Players, DVD Players, CD Players, MP3 Players, or Home Video Game Systems).

### 14. INPUT 1

Connection Type - Optical INPUT. If your TV does not have a headphone output, use the input to connect with the set-top-box by using the Optical INPUT cable (not included)

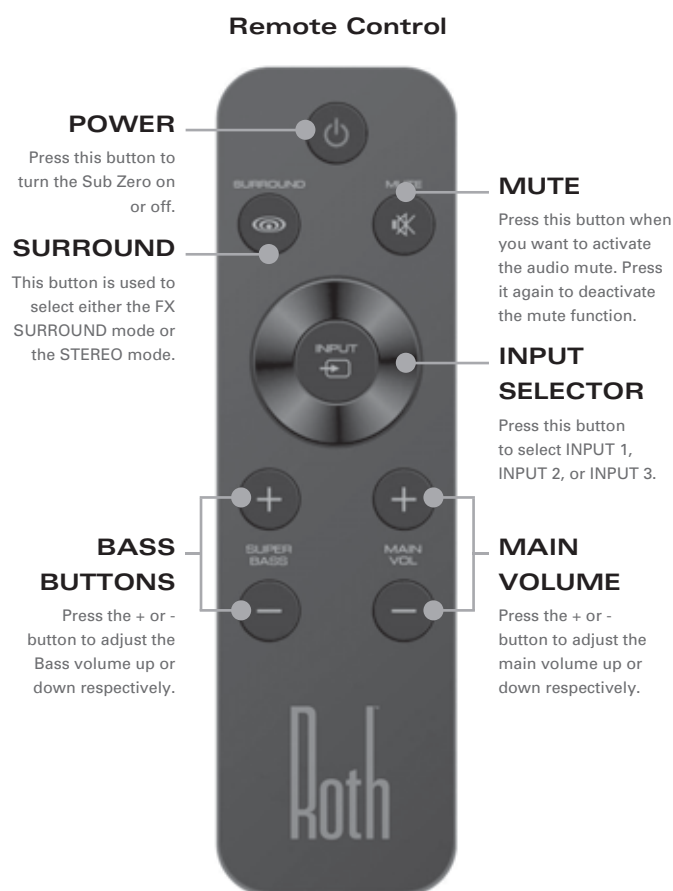

# ROTH SUB ZERO

## Hookup Diagram

### TV Audio Hookup - Case 1

If your TV has a headphone output, plug the supplied 3.5 mm mini stereo cable into the headphone output from your TV and plug the other end to the Input 3 jack on the back of your Sub Zero.

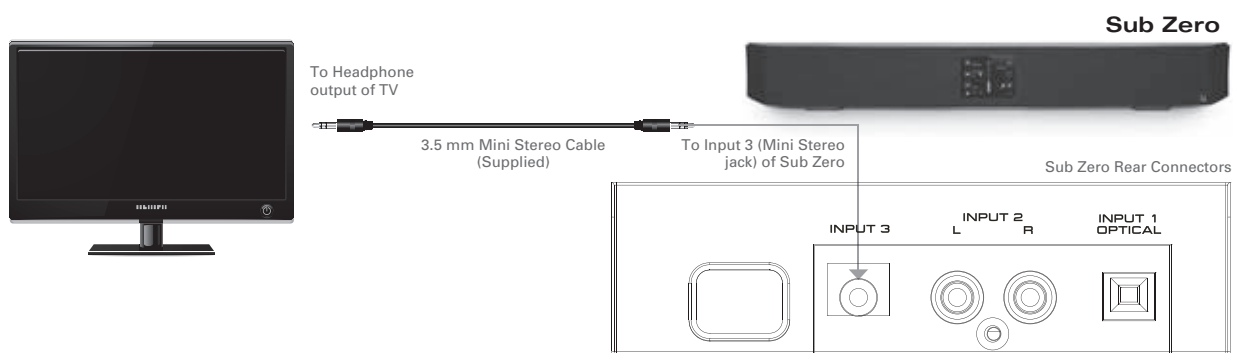

### TV Audio Hookup - Case 2

If your TV does not have a headphone output and you are using a set top box, plug one end of the included RCA cable into the audio outputs from your set top box and plug the other end into Input 2 on the back of your Sub Zero.

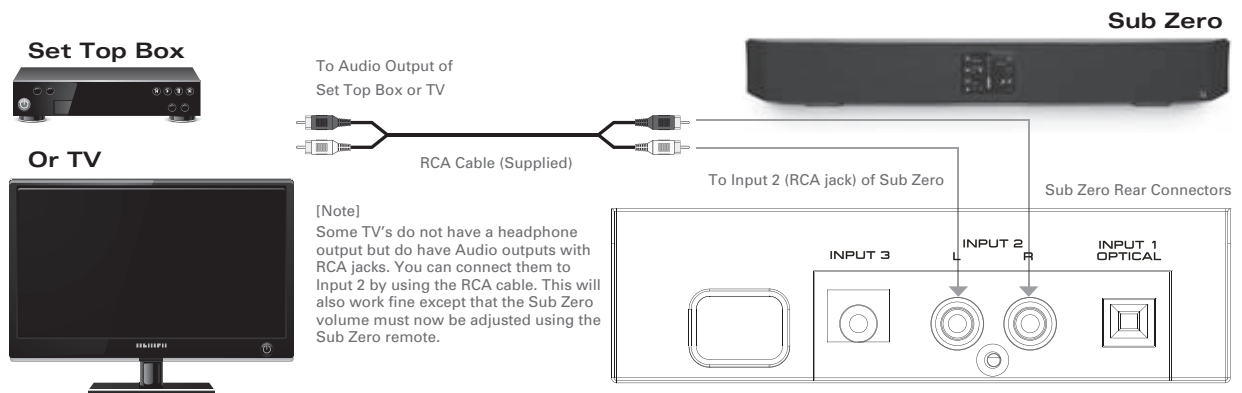

### Audio Hookup - Other Device

The Input 1 can be attached to Blu-ray, DVD or CD players or Home Video Game systems.

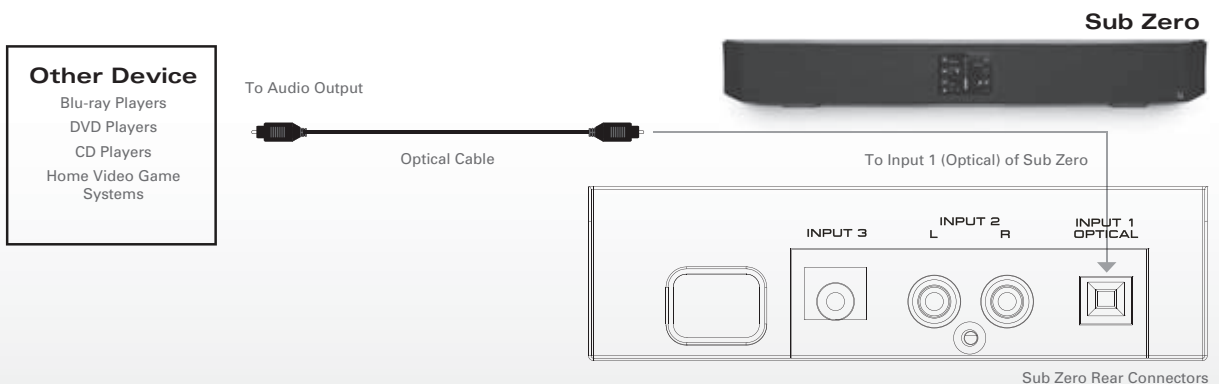

## Trouble Shooting

If you encounter problems when using this Sub Zero Soundbar, check the following points before requesting service.

In order to keep the warranty valid, please DO NOT try to repair the system yourself.

### 1. No power

- 1-1. Make sure power cords are securely connected to the AC outlet.
- 1-2. Make sure that there is power at the AC outlet.
- 1-3. Press the power button on the remote control or the front of the Sub Zero.

### 2. No sound

- 2-1. Press the Volume + (Up) button on the remote control or the front of the Sub Zero.
- 2-2. Make sure that you selected correct input (Input 1, Input 2, or Input 3).
- 2-3. Press MUTE on the remote to make sure the Sub Zero is not muted.
- 2-4. Make sure audio cables are securely connected at the terminals of the Sub Zero and the external devices.

### 3. Buzzing or humming noise

- 3-1. Make sure audio cables are securely connected at the terminals of the Sub Zero and the external devices.
- 3-2. Test on an alternate device or replace the audio cable.
- 3-3. Test the device and cable on an alternate input on the Sub Zero.

### 4. The remote control does not work

- 4-1. Aim the remote control directly at the sensor on the front of the Sub Zero.
- 4-2. Reduce the distance between the remote control and the Sub Zero.
- 4-3. Make sure that the battery is inserted with its polarities (+/- signs) aligned as indicated.
- 4-4. Replace the battery.

### 5. The buttons on both the remote control and front panel do not work

- 5-1. Unplug the power cord from the AC outlet, and plug back in after a few seconds.

# ROTH SUB ZERO

## Sub Zero Specifications

### Design

- 4 Speaker Drivers  
52mm 4 ohm x2, 88mm 4 ohm x2
- Thick Wall Reinforced Polymer Case
- Built-in 2pcs Ultra-bass Passive Woofer
- Wall Mount Capable (Brackets Included)
- Table Stands Included
- LED Display with Auto Dimming  
(Volume, Mute, Surround Mode)

### Performance Features

- Wide Frequency Response 35~20,000Hz
- High Power Class HD Amplifiers
- Low distortion VHR (Voltage Head Room)

### Soundbar

- (8) 40mm Long Throw Full Range Driver
- (2) 19mm Aluminum Dome Tweeter
- 64 Watts Peak (32Wx2)
- 32 Watts RMS (16W x 2)
- Frequency Response 180 ~ 20,000Hz

### Inputs

- (1) RCA Stereo Connectors  
(TV, DVD, DVRs, or Set - Top - Box)
- (1) 3.5 mm Stereo Mini Jack (TV, MP3 Players)
- (1) Optical Input
- Power Input: AC 230-240V, 50Hz

### Dimensions

- 790 mm width
- 105 mm height
- 89 mm depth

### Weight

- 3.1kgs

### General

- Operating Temperature: 5 °C~ 40°C (32°F~ 104°F)
- Power Requirements: AC 230-240V~50Hz
- Power Consumption: 65W

Class HD is a trademark of Audera International Sales Inc.  
All specifications, features and dimensions are subject to  
change without notice.



## Notes:

## Service

Please contact your local authorised dealer or reseller.

Email: [support@rothaudio.co.uk](mailto:support@rothaudio.co.uk)

# Roth™

[www.rothaudio.co.uk](http://www.rothaudio.co.uk)

In accordance with our policy of continuous development, we reserve the right to change specifications without notice. Photographs are for illustration only and actual product may vary. E&OE.

facebook

Find us on Facebook.  
Just search for Roth AV.

