

HEAT CONTROLLER, INC.

# **INSTALLATION MANUAL**

## **Indoor Models:**

B-VCH12FC-1

B-VCH18FC-1

B-VMH09FC-1

B-VMH12FC-1

B-VMH18FC-1

Version C

InverterFlex

Ductless Mini-Split Heat Pumps  
High Wall and Ceiling Cassettes

## **Outdoor Models:**

A-VCH18DC-1

A-VCH27TC-1

A-VMH36QC-1

# CONTENTS

## **SAFETY PRECAUTIONS**

Warning .....	2
Caution .....	2
Nomenclature Combinations.....	4

## **INSTALLATION INSTRUCTIONS**

Selecting installation place.....	3
Wall-mounted type .....	3
Accessories .....	4
Four-way cassette type .....	9
Duct & Ceiling type .....	12
Outdoor unit installation .....	23

## **REFRIGERANT PIPE CONNECTION**

Refrigerant pipe connection .....	24
-----------------------------------	----

## **ELECTRICAL WORK**

Electrical work .....	25
-----------------------	----

## **AIR PURGING**

Air purging with vacuum pump .....	27
Safety and leakage check .....	29

## **TEST RUNNING**

Test running .....	30
--------------------	----

### **Read This Manual**



Inside you will find many helpful hints on how to install and test the air conditioner properly. All the illustrations and specifications in the manual are subject to change without prior notice for product improvement. The actual shape should prevail.

### **CAUTION**

- Contact an authorised service technician for repair or maintenance of this unit.
- Contact an authorised installer for installation of this unit.
- The air conditioner is not intended for use by young children or infirmed persons without supervision.
- Young children should be supervised to ensure that they do not play with the air conditioner.
- If the power cord is to be replaced, replacement work shall be performed by authorised personnel only.
- Installation work must be performed in accordance with the national wiring Standards by authorised personnel only.





## SAFETY PRECAUTIONS

- Read the follow SAFETY PRECAUTIONS carefully before installation.
- Electrical work must be installed by a licensed electrician. Be sure to use the correct rating of the power plug and main circuit for the model to be installed.
- Incorrect installation due to ignoring of the instruction will cause harm or damage.
  - **The seriousness is classified by the following indications.**

 <b>WARNING</b>	This symbol indicates the possibility of death or serious injury.
 <b>CAUTION</b>	This symbol indicates the possibility of injury or damage to property.

- **The items to be followed are classified by the symbols:**

	Symbol with background white denotes item that is PROHIBITED from doing.
---	--

 <b>WARNING</b>	
1) Engage dealer or specialist for installation. If installation done by the user is defective, it will cause water leakage, electrical shock fire.	
2) Install according to this installation instructions strictly. If installation is defective, it will cause water leakage, electrical shock fire.	
3) Use the attached accessories parts and specified parts for installation. otherwise, it will cause the set to fall, water leakage, electrical shock fire.	
4) Install at a strong and firm location which is able to withstand the set's weight. If the strength is not enough or installation is not properly done, the set will drop and cause injury.	
5) For electrical work, follow the local national wiring standard, regulation and this installation instructions. An independent circuit and single outlet must be used. If electrical circuit capacity is not enough or defect found in electrical work, it will cause electrical shock fire.	
6) Use the specified cable and connect tightly and clamp the cable so that no external force will be acted on the terminal. If connection or fixing is not perfect, it will cause heat-up or fire at the connection.	
7) Wiring routing must be properly arranged so that control board cover is fixed properly. If control board cover is not fixed perfectly, it will cause heat-up at connection point of terminal, fire or electrical shock.	
8) When carrying out piping connection, take care not to let air substances other than the specified refrigerant go into refrigeration cycle. Otherwise, it will cause lower capacity, abnormal high pressure in the refrigeration cycle, explosion and injury.	
9) Do not modify the length of the power supply cord or use of extension cord, and do not share the single outlet with other electrical appliances. Otherwise, it will cause fire or electrical shock.	
 <b>CAUTION</b>	
1) This equipment must be earthed and installed with earth leakage current breaker. It may cause electrical shock if grounding is not perfect.	
2) Do not install the unit at place where leakage of flammable gas may occur. In case gas leaks and accumulates at surrounding of the unit, it may cause fire.	
3) Carry out drainage piping as mentioned in installation instructions. If drainage is not perfect, water may enter the room and damage the furniture.	

# NOMENCLATURE

## Outdoor Models:

### A - VMH18DC - 1

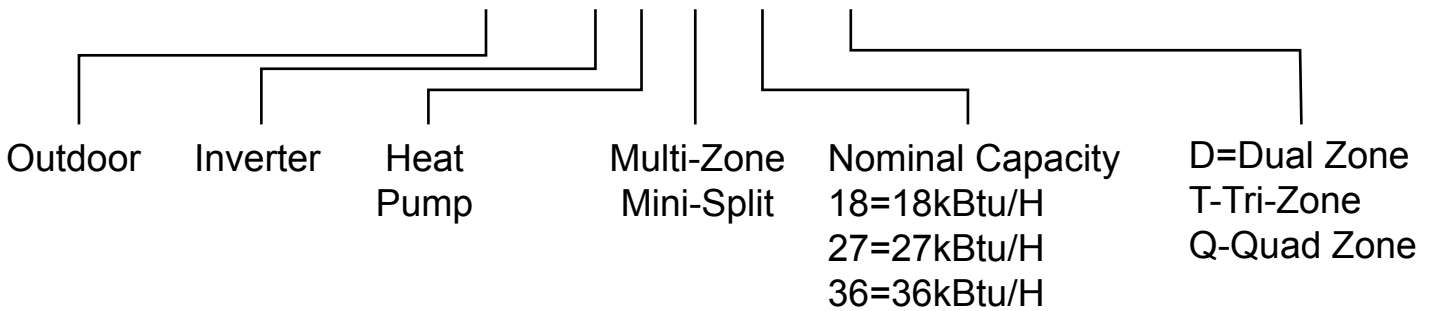

## Indoor Models:

### B - VMH09FC - 1

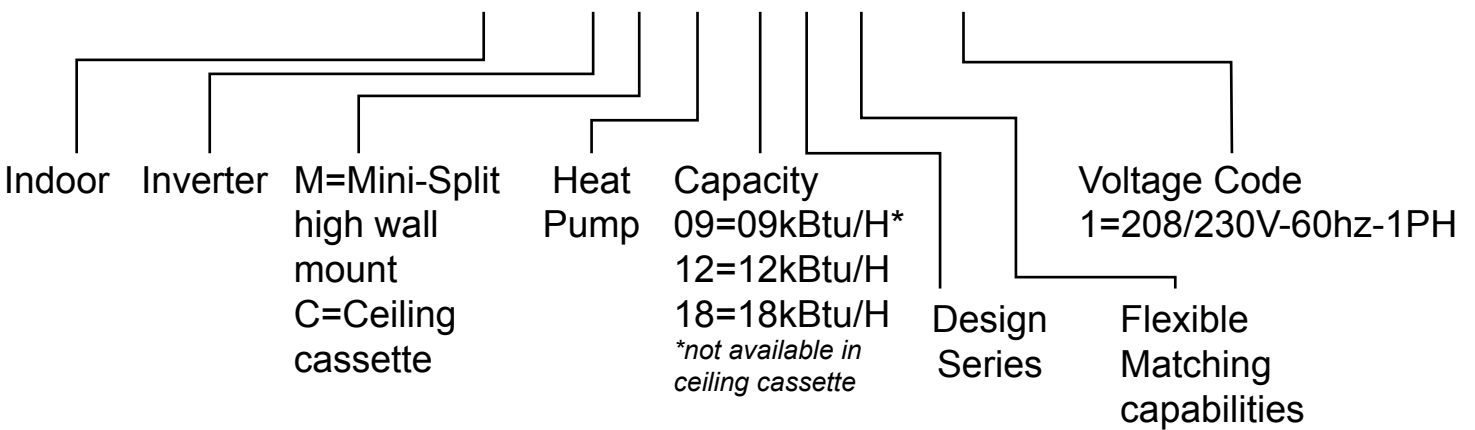

## Unit combinations

**NOTE:** The total capacity of indoor air handlers can not exceed the nominal capacity of the outdoor unit. The minimum quantity of indoor air handlers is one on any outdoor unit, whether it is a dual, tri, or quad zone.

### Indoor unit combinations for A-VMH18DC-1

Comb.	Combinations	
	Unit A	Unit B
Dual(1x1)	9k	—
	12k	—
	18k	—
Dual (1x2)	9k	9k
	9k	12k

### Indoor unit combinations for A-VMH27TC-1

Comb.	Combinations		
	Unit A	Unit B	Unit C
TRI (1x1)	9k	—	—
	12k	—	—
	18k	—	—
TRI (1x2)	9k	9k	—
	9k	12k	—
	9k	18k	—
	12k	12k	—
TRI (1x3)	9k	9k	9k

### Indoor unit combinations for A-VMH36QC-1

Comb.	Combinations			
	Unit A	Unit B	Unit C	Unit D
QUA (1x1)	9k	—	—	—
	12k	—	—	—
	18k	—	—	—
QUA (1x2)	9k	9k	—	—
	9k	12k	—	—
	9k	18k	—	—
	12k	12k	—	—
	12k	18k	—	—
	18k	18k	—	—
QUA (1x3)	9k	9k	9k	—
	9k	9k	12k	—
	9k	9k	18k	—
	9k	12k	12k	—
	12k	12k	12k	—
QUA(1x4)	9k	9k	9k	9k

### Available indoor models:

	High Wall Mount	Ceiling Cassette
9k	B-VMH09FC-1	N/A
12k	B-VMH12FC-1	B-VCH12FC-1
18k	B-VMH18FC-1	B-VCH18FC-1

**INSTALLATION INSTRUCTIONS**

**NOTE: Indoor units shown can be replaced with ceiling cassettes.**

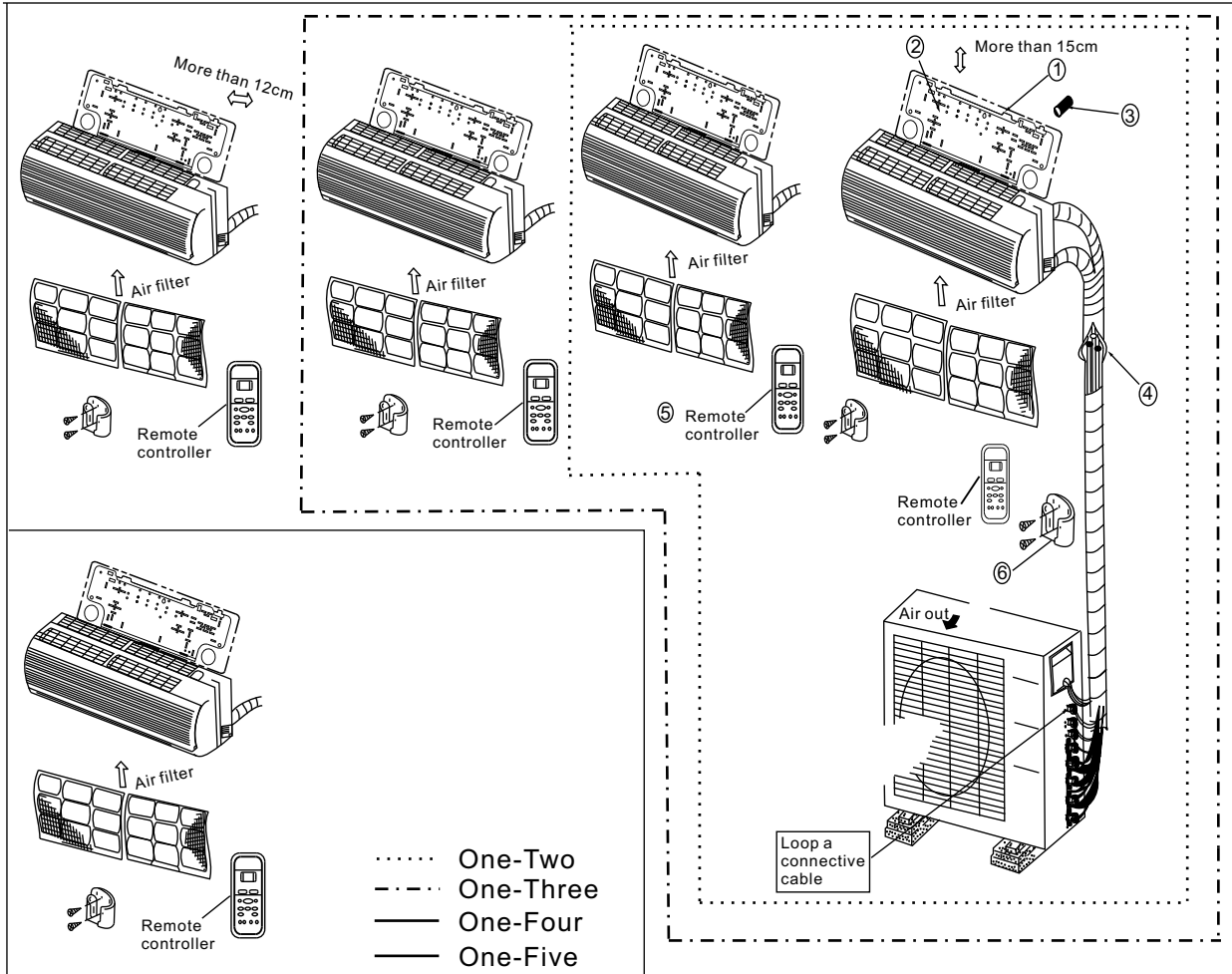

**CAUTIONS**

- This illustration is for explanation purposes only. The actual shape of your air conditioner may be slightly different.
- Copper lines must be insulated independently

**CAUTION**

- NOTE: Ceiling cassettes come with an optional wall mounted wireless thermostat that can take the place of the wireless remote controller.

### Pipe length and elevation

Unit	Pipe size		Standard length (m)	Max. Elevation B (m)	Max. Length A (m)	Additional refrigerant (g/m)
	Gas inch (mm)	Liquid inch (mm)				
9K	3/8" (Φ9.52)	1/4" (Φ6.35)	(5)	(10)	(15)	(20)
12K/18K	1/2" (Φ12.7)	1/4" (Φ6.35)	16.5ft	33ft	50ft	0.2 oz/ft
<b>Max. Total length for all rooms</b>			Dual-zone(m)	Tri-zone(m)	Quad-zone(m)	
			(30)100ft	(45)150ft	(60)200ft	

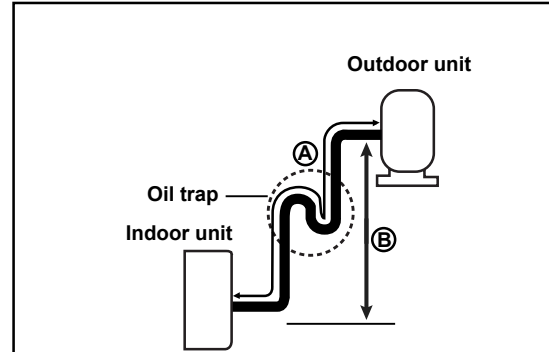
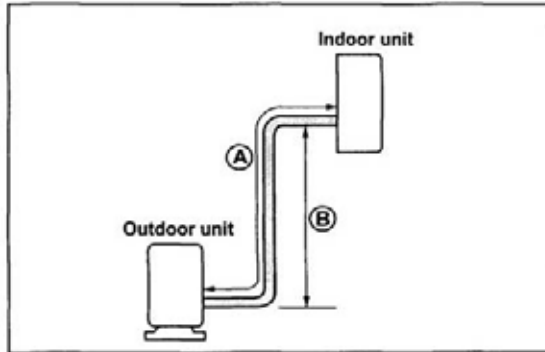

#### NOTES:

- Do not exceed 50 ft. (15m) per each indoor unit.
- Minimum pipe length of 10ft (3m) is required for each indoor unit.
- Oil trap should be installed per (3-5 meters) 10-15 ft., where outdoor unit is located above indoor unit.
- Outdoor connections are 1/4" (Φ6.35 mm) liquid and 3/8" (Φ9.52 mm) gas, therefore a flare nut adapter is provided with all 12/18k indoor sections.

## INSTALLATION INSTRUCTIONS

### 1. Selecting Installation Place

*Read completely, then follow step by step.*

#### Indoor unit

- Do not expose the indoor unit to heat or steam.
- Select a place where there are no obstacles in front or around the unit.
- Make sure that condensation drainage can be conveniently routed away.
- Do not install near a doorway.
- Ensure that the proper clearance is maintained per Fig.1.  
Use a stud finder to locate studs to prevent unnecessary damage to the wall.
- Variations in pipe length may require adjustment to refrigerant charge.
- There should not be any direct sunlight. Otherwise, the sun will fade the plastic cabinet and affect its appearance. If unavoidable, sunlight prevention should be taken into consideration.

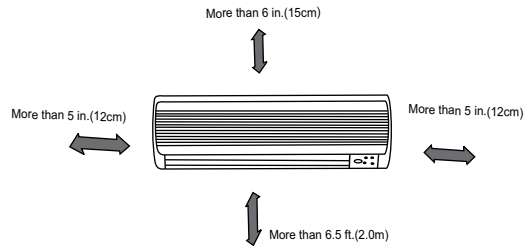

Fig.1

#### Outdoor unit

- If an awning is built over the outdoor unit to prevent direct sunlight or rain exposure, make sure that heat radiation from the condenser is not restricted.
- Ensure that the clearance is maintained per Fig 2.
- Do not place animals and plants in the path of the air inlet or outlet.
- Take the air conditioner weight into account and select a place where noise and vibration will not be an issue.
- Select a place so that the warm air and noise from the air conditioner do not disturb neighbors.

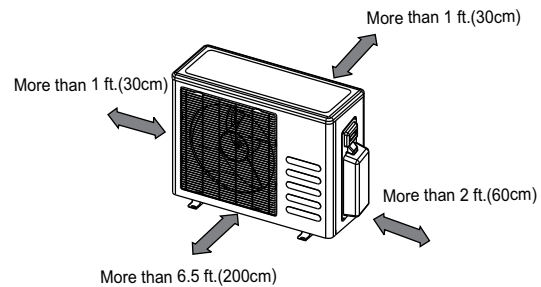

Fig.2

#### Clearance

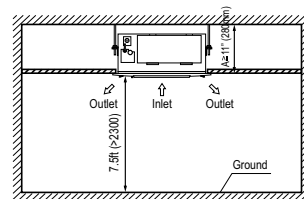

Fig.13

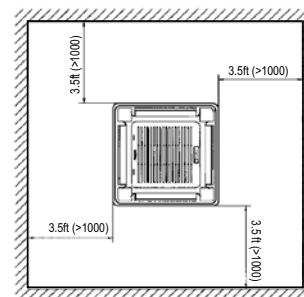

Fig.14



## INSTALLATION INSTRUCTIONS

### Tools needed for installation:

Level gauge  
Screwdriver  
Electric drill, Hole core drill  $\varnothing 1/4"$  (65mm)  
Flaring tool set  
Torque wrench: 1.8kgf.m, 4.2kgf.m,  
Spanner (half union)  
Hexagonal wrench 1-1/2" (4mm)  
Gas-leak detector

Vacuum pump  
Gauge manifold  
Users manual  
Thermometer  
Multimeter  
Pipe cutter  
Measuring tape

### Accessories for mini-split high wall mount installation

Number	Name of Accessories	Qty/one unit
1	Installation Plate	1 (high wall mount only)
2	Dry wall anchors	5-8 (depending on models)
3	Self-tapping Screw A ST3.9X25	5-8 (depending on models)
5	Remote controller	1
6	Self-tapping Screw B ST2.9X10	Optional parts
7	Remote controller holder	
8	Seal (outdoor heat pumps only)	1
9	Drain Joint (outdoor heat pumps only)	1
10	FLARE NUT ADAPTER 3/8" FFL to 1/2" flare nut provided with some indoor models as required to make with the outdoor units line set.	1 (on some models)
11	FERRILE COR FILTER (clip-on) optionally installed on the communication cable between the indoor and outdoor unit to reduce EMI RFI noise.	Optional

**Note:** Except for the above parts provided, any other parts needed during installation you must purchase.

**Note:** The seal and drain connector elbow are only available with some models. Your particular product may not come with these parts factory supplied, however they can be purchased locally. All other parts required for installation must be purchased separately/locally including but not limited to tools, line sets, insulation etc.

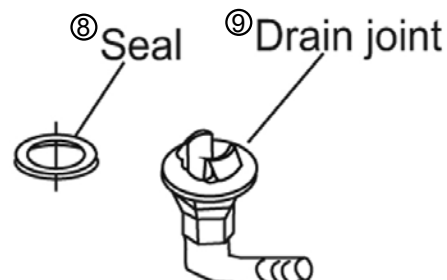

# INSTALLATION INSTRUCTIONS

## Indoor unit installation(wall-mounted type)

### 1. Fit the Installation Plate

1. Fit the installation plate horizontally on structural parts (studs) of the wall with spaces around the installation plate.
2. If the wall is made of brick, concrete or the like, drill five or eight 3/16”(5mm) diameter holes in the wall. Insert Clip anchor for appropriate mounting screws.
3. Fit the installation plate on the wall with five to eight type “A” screws.

**Note:**

1. Fit the Installation Plate and drill holes in the wall according to the wall structure and corresponding mounting points on the installation plate.
2. The Installation Plate may be slightly different according to the different models of indoor unit.
3. Use a stud finder to locate the studs to prevent any unnecessary damage to the wall.

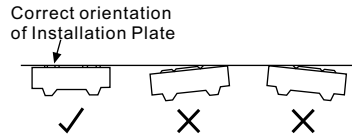
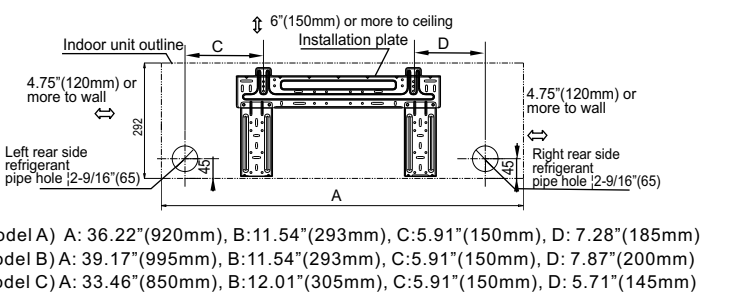
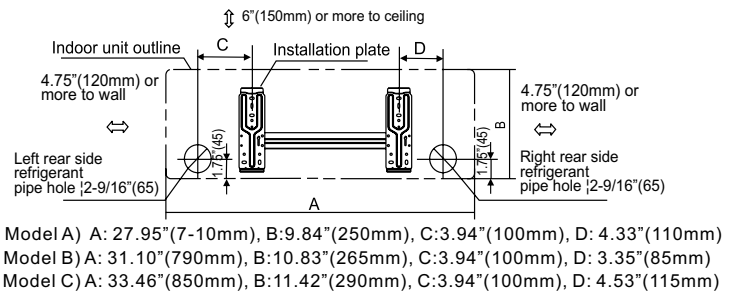
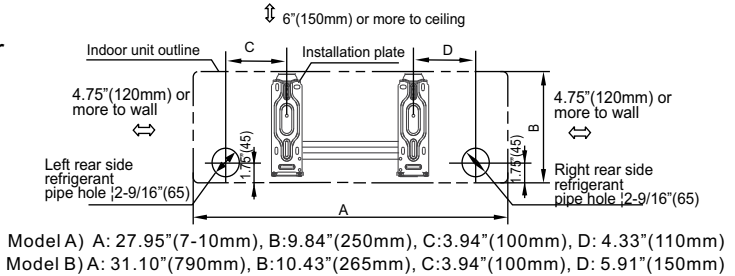

Fig.4



### 2. Drill a hole in the wall

1. Determine hole positions according to the diagram detailed in Fig.5. Drill one (1) hole 2-9/16”(65mm) slanting slightly to outdoor side see Fig. 6.
2. Always use wall hole conduit when drilling metal grid, metal plate or the like.

### 3. Connective Pipe and Drainage Installation

#### Drainage

1. Run the drain hose sloping downward. Do not install the drain hose as illustrated in Fig.7.

Fig.5

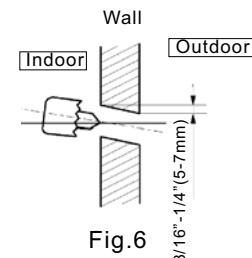

Fig.6

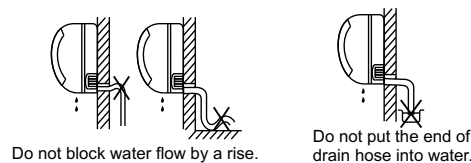

Fig.7

## INSTALLATION INSTRUCTIONS

- When connecting the drain extension hose, insulate the connection of extension drain hose with a shield pipe, do not let the drain hose slack.

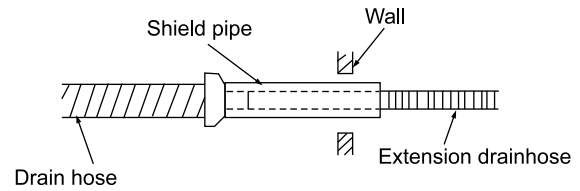

Fig. 8

### Connective pipe installation

- For the left-hand and right-hand piping, remove the pipe cover from the side panel.
- For the rear-right-hand and rear-left-hand piping, install the piping as shown in Fig. 10.
- Fix the end of the connective pipe. (Refer to Tightening Connection in REFRIGERANT PIPING CONNECTION)

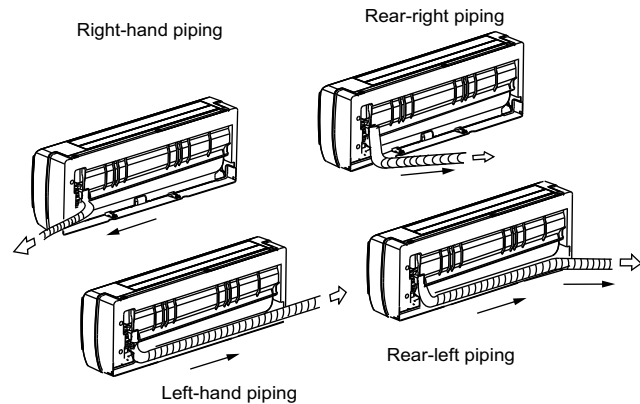

Fig. 9

Fig. 10

### 4. Piping and wrapping

Bundle the tubing, connecting cable, and drain hose with tape securely, evenly as shown in Fig. 11.

- Because the condensed water from rear of the indoor unit is gathered in ponding box and is piped out of room. Do not put anything else in the box.

#### CAUTION

- Connect the indoor unit first, then the outdoor unit.
- Do not allow the piping to let out from the back of the indoor unit.
- Be careful not to let the drain hose slack.
- Heat insulate both of the auxiliary piping.
- Be sure that the drain hose is located at the lowest side of the bundle. Locating at the upper side can cause drain pan to overflow inside the unit.
- Never intercross nor intertwine the power wire with any other wiring.
- Run the drain hose sloped downward to drain out the condensed water smoothly.

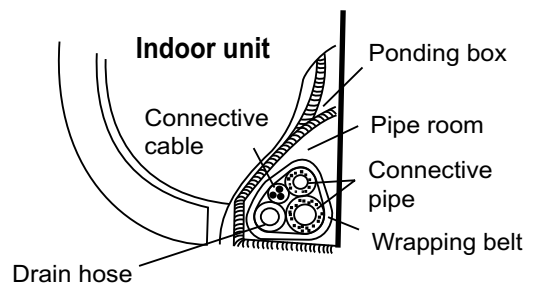

Fig. 11

## INSTALLATION INSTRUCTIONS

---

### 4. Indoor unit installation

1. Pass the piping through the hole in the wall.
2. Put the upper claw at the back of the indoor unit on the upper hook of the installation plate, move the indoor unit from side to side to see that it is securely fastened (see Fig.12).
3. For easier installation separate the bottom of the indoor unit from the wall by inserting a spaces, such as a piece of foam between the unit and the wall. Remove the spaces after the piping is complete.
4. Push the lower part of the indoor unit up on the wall, then move the indoor unit from side to side, up and down to check that the unit has engaged with the lower hook of the installation plate.

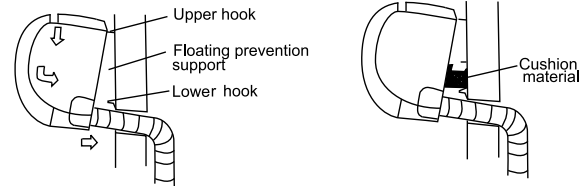
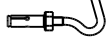

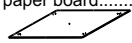











Fig.12

## INSTALLATION INSTRUCTIONS

### 2. Four-way cassette type

#### Included Pans

Installation Fittings	Tubing & Fittings	Remote controller	Wired wall mounted controller
1. Expansable hook.....4  2. Installation hook.....4  3. Installation paper board.....1  4. Bolt M5;16 or M6;12.....4  5. Fernte Core Filter.....1 	6. Connecting pipe group.....1  7. Binding tape.....6  8. Soundproof / insulation sheath.....2 	9. Remote controller.....1  10. Holder.....1  11. Mounting screw(ST2.9 × 10-C-H) ...2  12. Alkaline dry batteries (AM4).....2 	

#### Ceiling Cassette installation

##### 1. Install the main body

A. The existing ceiling (to be horizontal)

a. Please cut a quadrangular hole of 600;600mm in the ceiling according to the shape of the installation paper board. (Refer to Fig.15 & 16) The center of the hole should be at the same position of that of the air conditioner body. Determine the lengths and outlets of the connecting pipe, drain pipe and cables.

To balance the ceiling and to avoid vibration, please enforce the ceiling when necessary.

b. Please select the position of installation hooks according to the hook holes on the installation board.

- Drill four holes of 12mm, 50~55mm deep at the selected positions on the ceiling. Then embed the expansible hooks(fittings).

Face the concave side of the installation hooks

- toward the expansible hooks. Determine the length of the installation hooks from the height of ceiling, then cut off the unnecessary part.

If the ceiling is extremely high, please determine the length of the installation hook according to

- facts.
- Cut the installation hook open in the middle position, then use appropriate length of reinforcing rod ( 12) to weld together.

#### Clearance

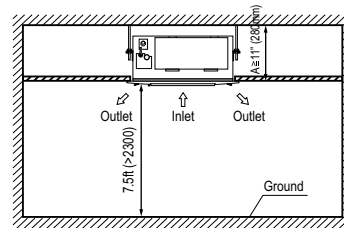

Fig.13

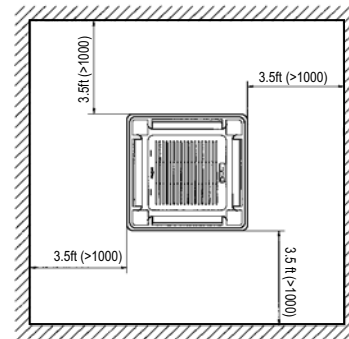

Fig.14

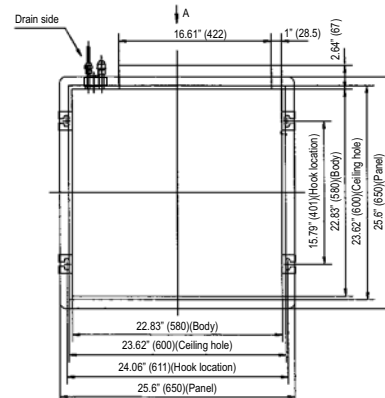

Fig.15

## INSTALLATION INSTRUCTIONS

The length could be calculated from Fig.17:  
 Length=210+L(in general, L is half of the whole length of the installation hook)

- c. Please adjust the hexangular nuts on the four installation hooks evenly, to ensure the balance of the body.
- Use the transparent hose filled with water to check the lever of the main body from the four sides or diagonal line direction, the lever indicator also can check the lever from four sides of the main body .(Refer to Fig.18)
- If the drainpipe is awry, leakage will be caused by the malfunction of the water-level switch.
- Adjust the position to ensure the gaps between the body and the four sides of ceiling are even.
- The body's lower part should sink into the ceiling for 10~12mm (Refer to Fig.17).
- Locate the air conditioner firmly by wrenching the nuts after having adjusted the body's position well.

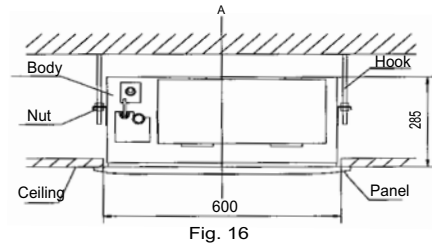

Fig. 16

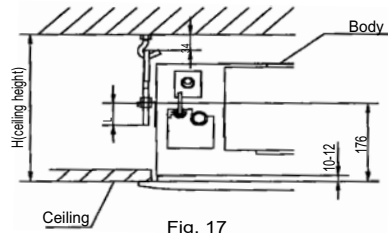

Fig. 17

### New built houses and ceilings

- a. In the case of new built house, the hook can be embedded in advance (refer to the A.b mentioned above). But it should be strong enough to bear the indoor unit and will not become loose because of concrete shrinking.
- b. After installing the body, please fasten the installation paper board onto the air conditioner with bolts (M5;16) to determine in advance the sizes and positions of the hole opening on ceiling. Please first guarantee the flatness and horizontal of ceiling when installing it. Refer to the A.a mentioned above for others.
- c. Refer to the A.c mentioned above for installation.
- d. Remove the installation paper board.

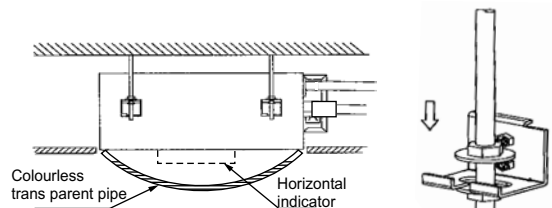

Fig.18

Fig.19

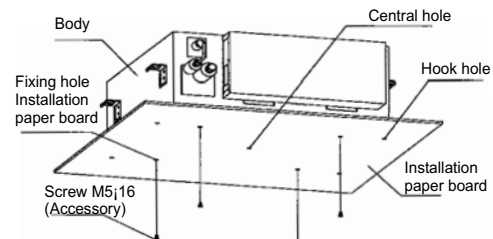

Fig.20

## 2. Install The Panel

### CAUTIONS

- Never put the panel face down on floor or against the wall, or on bulgy objects.
- Never crash or strike it.

### (1) Remove the inlet grid.

- a. Slide two grid switches toward the middle at the same time, and then pull them up. (Refer to Fig.21)
- b. Draw the grid up to an angle of about 30°, and remove it. (Refer to Fig.22)

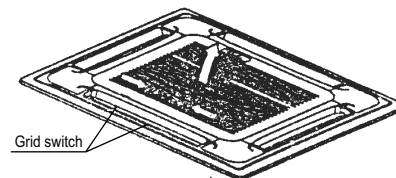

Fig.21

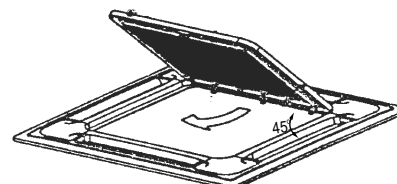

Fig.22

## INSTALLATION INSTRUCTIONS

### (2) Install the panel

- a. Align the swing motor on the panel to the water receiver of the body properly. (Refer to Fig.23)
- b. Hang the four fixed rope of the main body to the installation cover and the other three covers of the swing motor: (Refer to Fig.23 )

### CAUTIONS:

- The installation cover of the swing motor must sink into the corresponding water receiver.
- c. Install the panel on the main body with bolt (M5;16) and washer. (Refer to Fig.23)
  - d. Adjust the four panel hook screws to keep the panel horizontal, and screw them up to the ceiling evenly.
  - e. Regulate the panel in the direction of the arrow in Fig.11 slightly to fit the panel's center to the center of the ceiling's opening. Guarantee that hooks of four corners are fixed well.
  - f. Keep fastening the screws under the panel hooks, until the thickness of the sponge between the body and the panel's outlet has been reduced to about 4~6mm. The edge of the panel should contact with the ceiling well. (Refer to Fig.24) Malfunction described in Fig.25 can be caused by inappropriate tightness the screw. If the gap between the panel and ceiling still exists after fastening the screws, the height of the indoor unit should be modified again. You can modify the height of the indoor unit through the openings on the panel's four corners, if the lift of the indoor unit and the drainpipe is not influenced (refer to Fig.26-right).
- (3) Hang the air-in grid to the panel, then connect the lead terminator of the swing motor and that of the control box with corresponding terminators on the body respectively.
  - (4) Relocate the air-in grid in the procedure of reversed order, install the air-in grid.

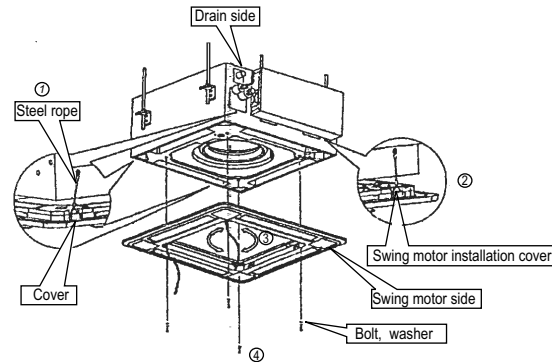

Fig.23

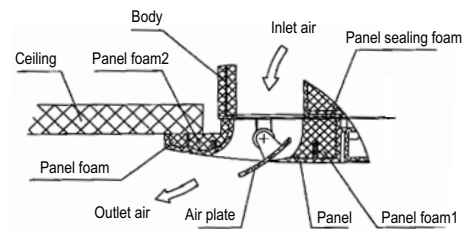

Fig.24

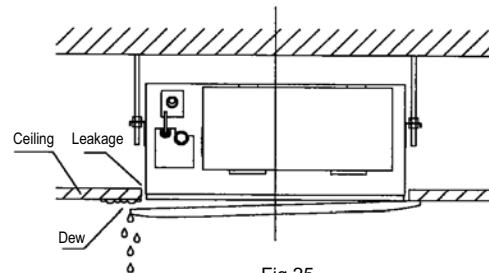

Fig.25

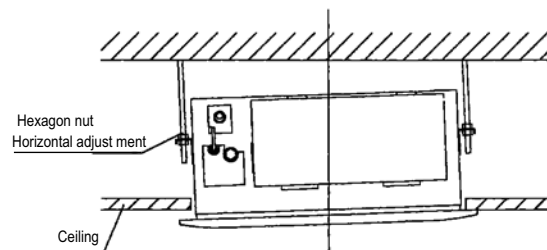

Fig.26

## Outdoor Unit Installation

### Outdoor installation precaution

- Install the outdoor unit on a rigid base to prevent increasing noise level and vibration.
- Determine the air outlet direction where the discharged air is not blocked. If the installation place is exposed to strong winds, ensure the unit is lengthwise along the wall or provide a suitable air baffle.
- If suspending the unit, follow the bracket manufacturer's instructions.
- Use a raised concrete pad or concrete blocks to provide a solid, level surface. Securely anchor the unit down with bolts.
- Be sure there are no obstacles which block radiating air.
- In a snowy area, install the outdoor unit on a raised platform that is higher than drifting snow.

### Anchoring outdoor unit

Anchor the outdoor unit with 5/16" (8mm) or 3/8" (10mm) bolt and nut tightly and horizontally on a concrete or rigid mount.

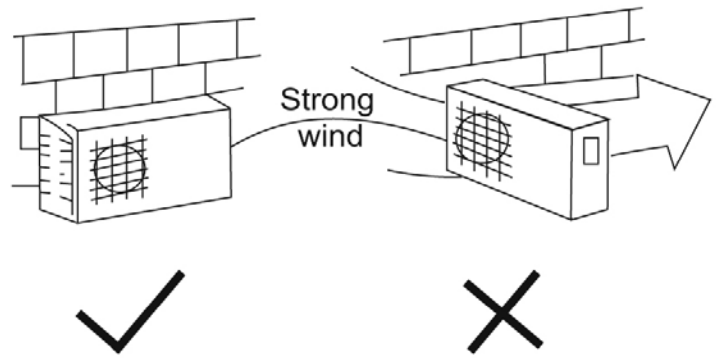

Fig.44

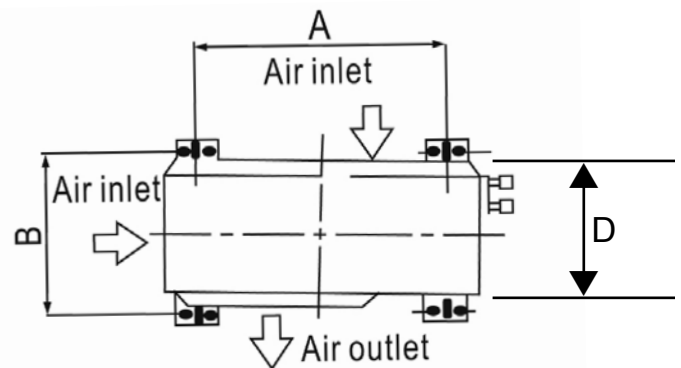
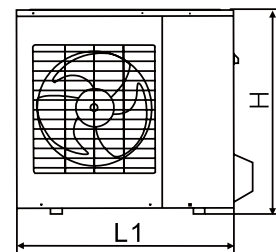

Fig. 45

Outdoor unit dimensions WxHxD in. (mm)	Mounting Dimensions	
	A in. (mm)	B in. (mm)
29.9 x 23.2 x 11.2 (760 x 590 x 285)	20.9 (530)	11.4 (290)
33.3 x 27.4 x 13.2 (845 x 695 x 335)	22 (560)	13.2 (335)
35.2 x 33.9 x 13.0 (895 x 860 x 330)	23.2 (590)	13.1 (333)
39.0 x 38.0 x 14.0 (990 x 965 x 355)	24.5 (623)	14.4 (366)





## REFRIGERANT PIPE CONNECTION

### Drain joint installation

Fit the seal into the drain elbow, then insert the drain joint into the base pan hole of outdoor unit, rotate 90° to securely assemble them.

Connecting the drain joint with an extension drain hose (Locally purchased), in case of the water draining off the outdoor unit during the heating mode.

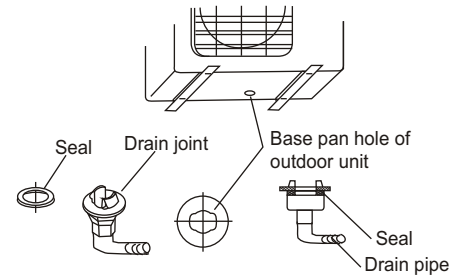

Fig.46

### Refrigerant pipe connection

#### 1. Flaring work

Main cause for refrigerant leakage is due to defect in the flaring work.

Carry out correct flaring work using the following procedure:

#### A: Cut the pipes and the cable.

1. Use the piping kit accessory or pipes purchased locally.
2. Measure the distance between the indoor and the outdoor unit.
3. Cut the pipes a little longer than the measured distance.
4. Cut the cable 1.5m longer than the pipe length.

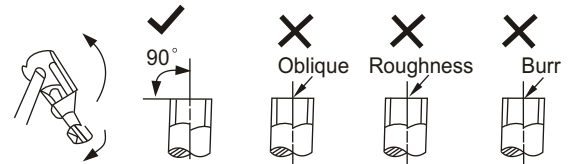

Fig.47

#### B: Burr removal

1. Completely remove all burrs from the cut cross section of pipe/tube.
2. Put the end of the copper tube/pipe in a downward direction as you remove burrs in order to avoid dropping burrs into the tubing.

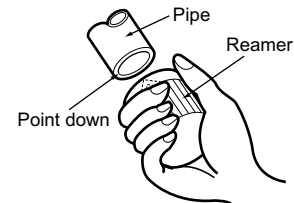

Fig.48

#### C: Putting nut on

Remove flare nuts attached to indoor and outdoor unit, then put them on pipe/tube having completed burr removal. (not possible to put them on after flaring work)

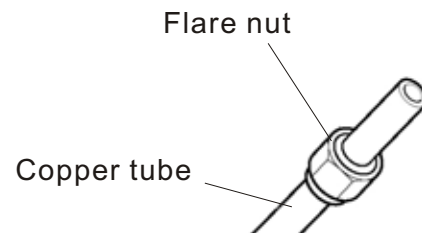

Fig.49

## Refrigerant Pipe Connection

### D: Flaring work

Firmly hold copper pipe in a die in the dimension shown in the table below.

Outer diameter in. (mm)	A in. (mm)	
	Max.	Min.
φ 1/4" (6.35)	0.5 (1.3)	0.276 (0.7)
φ 3/8" (9.35)	0.63 (1.6)	0.394 (1.0)
φ 1/2" (12.7)	0.709 (1.8)	0.394 (1.0)

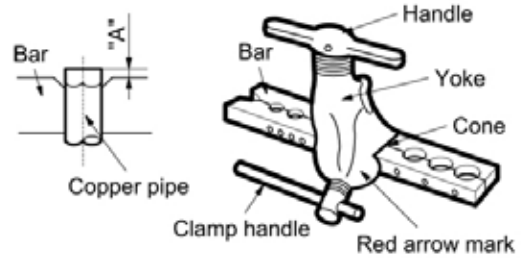

Fig.50

### Tightening Connection

- Align the center of the pipes.
- Sufficiently tighten the flare nut with fingers, and then tighten it with a spanner and torque wrench as shown in Fig.51 & 52.

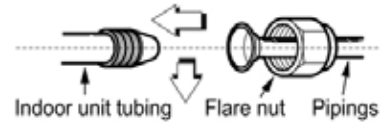

Fig.51

Outer Diameter	Tightening torque	Additional tightening torque
φ 1/4" (6.35)	11.57 ft-lb (160 kgf-cm)	14.46 ft-lb (200 kgf-cm)
φ 3/8" (9.35)	21.69 ft-lb (300 kgf-cm)	25.3 ft-lb (350 kgf-cm)
φ 1/2" (12.7)	36.17 ft-lb (500 kgf-cm)	39.78 ft-lb (550 kgf-cm)

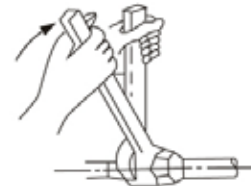

Fig.52

### Caution

Excessive torque can break nut depending on installation conditions.

## ELECTRICAL WORK

### Wiring connection

**NOTE:** Before performing any electrical work, turn off the main power to the system.



### CAUTION

1. All wiring must comply with local and national electrical codes
2. Unit should be grounded in compliance with local and national electrical codes.
3. Wiring cable size and type must comply with all applicable local and national codes.
4. Unit must have an individual branch circuit.
5. Do not touch the capacitor, even if you have disconnected the power. A charge may remain inside the capacitor or at least 5 minutes. To reduce the risk of electrical shock, wait 5 minutes before doing any electrical work.
6. Turn off power supply to unit before doing any work
7. Check unit's labels and data plates for information regarding voltage, max fuse/HACR circuit breakers, min. circuit ampacity.
8. Ensure all wiring is completed per the unit's wiring diagram. Power is supplied to the outdoor unit. The indoor unit's are connected to the outdoor unit using signal wires.

### Connect the cable to the outdoor unit:

1. Remove the electrical control board cover from the outdoor unit by loosening the appropriate screws.
2. Connect power wires (L, N, and Ground) to the unit's terminal block.
3. Connect the communication cable to each indoor unit, then to the appropriate terminal block on the outdoor unit. Ensure that the wiring matches between indoor and outdoor units.
4. Use the cable clamp on the outdoor unit to prevent stress on the connections.
5. To prevent water from entering the electrical components of the unit, form a "p" trap or loop with the cable.
6. Insulate only unused conductors with PVC electrical tape and ensure that they do not touch any electrical or metal parts.



### CAUTIONS

Make sure to connect the indoor unit (A, B, C, D, E) to the Hi and Lo valve and terminals of signal wires (A, B, C, D, E) of outdoor unit as identified with their respective matched connection. Wrong wiring connections may cause some electrical parts to malfunction.

### Minimum nominal cross-sectional area of conductors:

Rated current of appliance (A)	Nominal cross-sectional area (mm <sup>2</sup> )
>3 and ≤6	0.75
>6 and ≤10	1
>10 and ≤16	1.5
>16 and ≤25	2.5

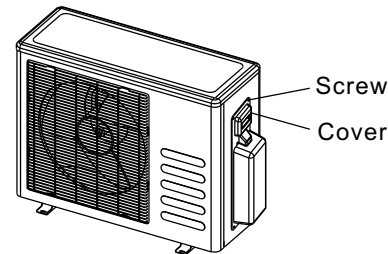

Fig.53

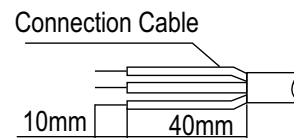
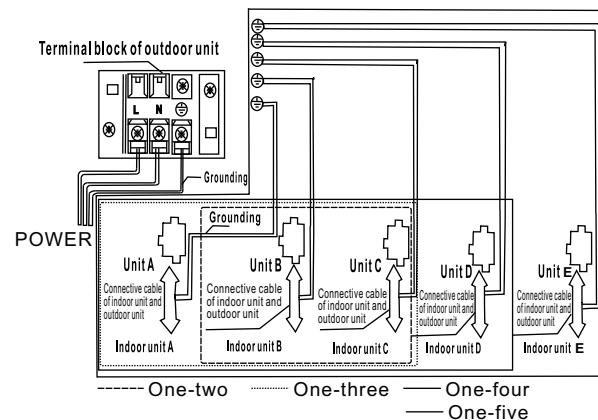

Fig.54



## ELECTRICAL WORK

**NOTE:** please refer to the following figures, if the client want wire by themselves.

### One-two models:

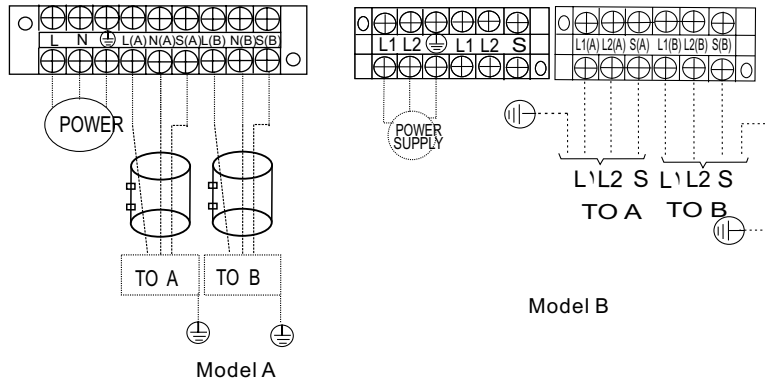

### One-three models:

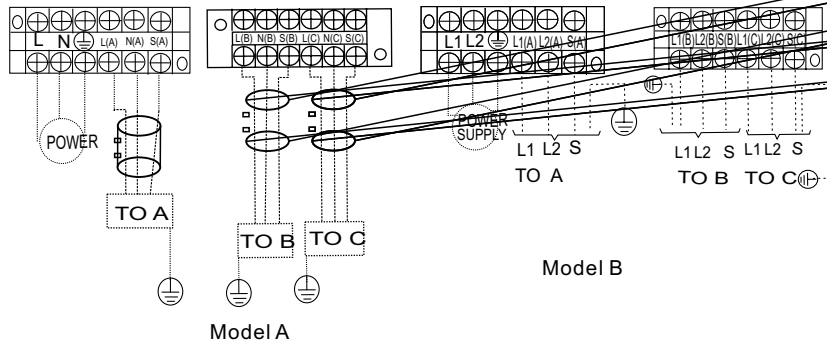

### One-four models:

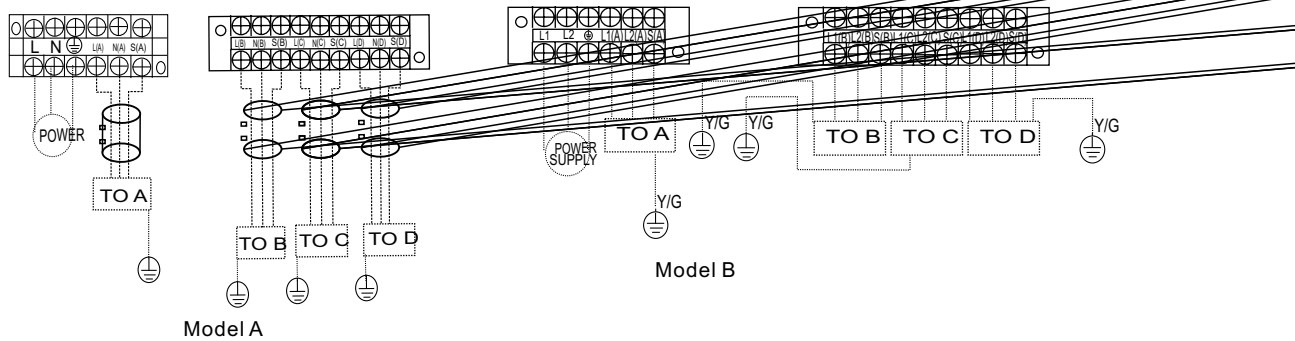

## Air Purging

Air and moisture in the refrigerant system have undesirable effects as indicated below:

- Pressure in the system rises.
- Operating current rises.
- Cooling or heating efficiency drops.
- Moisture in the refrigerant circuit may freeze and block capillary tubing.
- Water may lead to corrosion of parts in the refrigeration system.

Therefore, the indoor unit and tubing between the indoor and outdoor unit must be leak tested and evacuated to remove any noncondensables and moisture from the system.

### Air purging with vacuum pump

#### Preparation

- Check that each tube(both liquid and gas side tubes) between the indoor and outdoor units have been properly connected and all wiring for the test run has been completed. Remove the service valve caps from both the gas and the liquid side on the outdoor unit. Note that both the liquid and the gas side service valves on the outdoor unit are kept closed at this stage.
- Unit charge is located on the rating plate.
- Unit is precharged to include enough refrigerant for 16.5 ft (5m) of line set length per each indoor unit allowed.

Example: A quad zone 36k outdoor unit will accept up to four indoor units at 16.5 ft (5m) each for a total factory charge to handle 66 ft (20m) of total line set length.

- Charge adjustment is not required for line set lengths less than 16.5 ft. (5m).
- Add .2 oz./ft. of additional charge for line set lengths above 16.5 (5m) per indoor unit.
- The 12k and 18k indoor units include a line set adaptor for the outdoor section.

Capacity Btu/H	Pipe Size	
	Gas (in.)	Liquid (in.)
9k Indoor	3/8"	1/4"
12k Indoor	1/2"	1/4"
18k Indoor	1/2"	1/4"

Capacity Btu/h	Indoor Unit Combination	Standard Length Per Indoor Unit	Maximum Elevation	Total Line Length	
				Min.	Max.
18k Dual Zone	(A + B)	16.5 ft. (5m)	32 ft. (10m)	10 ft. (3m)	100 ft. (30.5m)
27k Tri Zone	(A + B + C)	16.5 ft. (5m)	32 ft. (10m)	10 ft. (3m)	150 ft. (45m)
36k QuadDual Zone	(A + B + C)	16.5 ft. (5m)	32 ft. (10m)	10 ft. (3m)	200 ft. (60m)

## Air Purging

- When relocating the unit to another place, perform evacuation using vacuum pump.
- Make sure the refrigerant added into the air conditioner is liquid form.

### Caution in handling the packed valve

- Open the valve stem until it hits against the stop. Do not try to open it further.
- Securely tighten the valve stem cap with a spanner or the like.
- Valve stem cap tightening torque (see tightening torque table).

### When Using the Vacuum Pump

(For method of using a manifold valve, refer to its operation manual.)

1. Completely tighten the flare nuts, A, B, C, D, connect the manifold valve charge hose to a charge port of the low-pressure valve on the gas pipe side.
2. Connect the charge hose connection to the vacuum pump.
3. Fully open the Lo handle of the manifold valve.
4. Operate the vacuum pump to evacuate. After starting evacuation, slightly loose the flare nut of the Lo valve on the gas pipe side and check that the air is entering (Operation noise of the vacuum pump changes and a compound meter indicates 0 instead of minus)
5. After the evacuation is complete, fully close the Lo handle of the manifold valve and stop the operation of the vacuum pump. Evacuate for 15 minutes or more and check that the compound meter indicates -29.92 inHg (-1x10<sup>5</sup>Pa).
6. Turn the stem of the packed valve B about 45° counterclockwise for 6~7 seconds after the gas comes out, then tighten the flare nut again. Make sure the pressure display in the pressure indicator is a little higher than the atmosphere pressure.
7. Remove the charge hose from the Low pressure charge hose.
8. Fully open the packed valve stems B and A.
9. Securely tighten the cap of the packed valve.

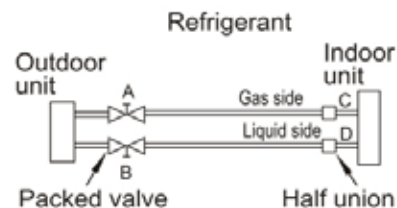

Fig.60

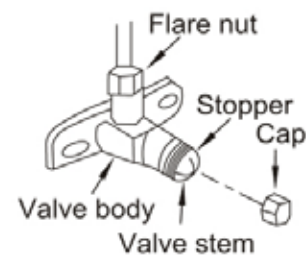

Fig.61

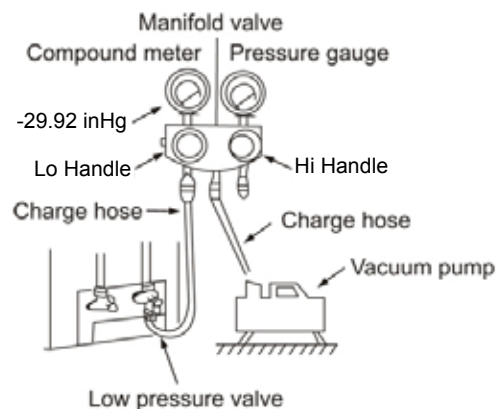

Fig.62

## Air Purging

### Safety and Leak Check

#### ● Electrical safety check

Perform the electric safe check after completing installation:

1. Insulated resistance  
The insulated resistance must be more than  $2M \Omega$ .
2. Grounding work  
After finishing grounding work, measure the grounding resistance by visual detection and grounding resistance tester. Make sure the grounding resistance is less than  $4 \Omega$ .
3. Electrical leakage check (performing during test run).  
During test operation after finishing installation, the serviceman can use the electroprobe and multimeter to perform the electrical leakage check. Turn off the unit immediately if leakage happens. Check and find out the solution ways till the unit operate properly.

#### ● Refrigerant Leak Check

1. **Soap water method:**  
Apply a soap water or a liquid neutral detergent on the indoor unit connection or outdoor unit connections with a soft brush to check for leakage of the connecting points of the piping. If bubbles come out, the pipes have leakage.
2. **Leak detector**  
Use the leak detector to check for leakage.

### CAUTION

A: Lo packed valve B: Hi packed valve  
C and D are ends of indoor unit connection.

**NOTE:** The illustration is for explanation purposes only. The actual order of A, B, C and D on the machine may be slightly different from the unit you purchased. The actual shape shall prevail.

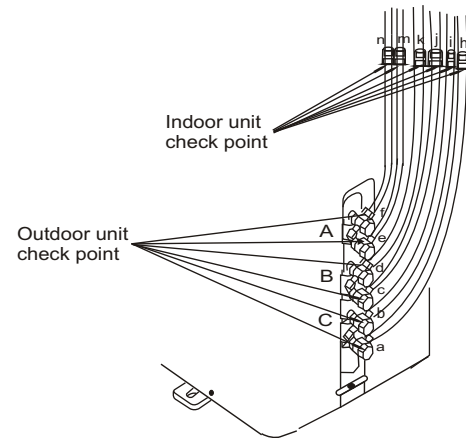

a,b,c,d,h,i,j , k are points for one-two type.  
a,b,c,d,e,f,,h,i,j,k,m,n are points for one-three type.

Fig.63

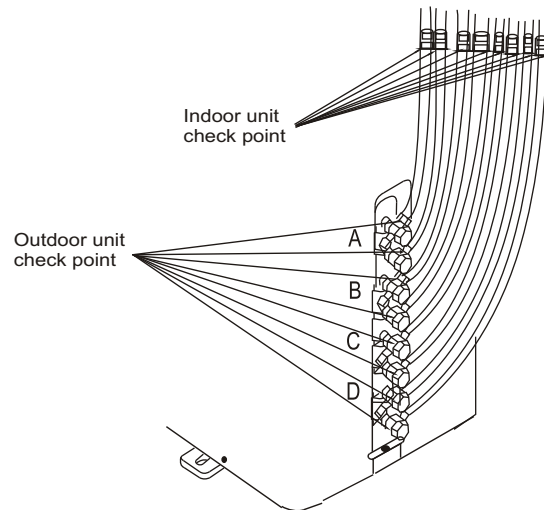

One-four type

Fig.64

## Testing the System

Perform test operation after completing gas leak check at the flare nut connections and electrical safety check.

- Check that all tubing and wiring have been properly connected.
  - Check that the gas and liquid side service valves are fully open.
1. Connect the power, press the ON/OFF button on the remote controller to turn the unit on.
  2. Use the MODE button to select COOL, HEAT, AUTO and FAN to check if all the functions work well.
  3. When the ambient temperature is too low(lower than 62.2°F (17°C)), the unit cannot be controlled by the remote controller to run in cooling mode, manual operation can be used. Manual operation is used only when the remote controller is disable or maintenance necessary.
    - Hold the panel sides and lift the panel up to an angle until it remains fixed with a clicking sound.
    - Press the Manual control button to select the AUTO or COOL, the unit will operate under Forced AUTO or COOL mode(see User Manual for details).
  4. The test operation should last about 30 minutes.

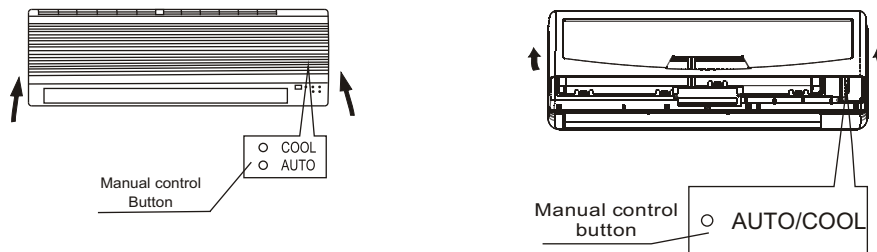

Fig.65



Design, material, performance data and components  
subject to change without notice.

## HEAT CONTROLLER, INC.

1900 Wellworth Ave., Jackson, MI 49203 ♦ Ph. 517-787-2100 ♦ Fax 517-787-9341

THE QUALITY LEADER IN CONDITIONING AIR

[www.heatcontroller.com](http://www.heatcontroller.com)