



DIGITAL COLOR PRINTER

MODEL

CP3800DW

User's Manual

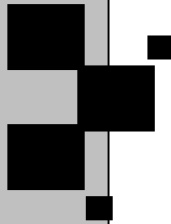

DEUTSCH ENGLISH

DIGITAL COLOR PRINTER

- Concerning Copyright

The copyrights for this document are the property of Mitsubishi Electric Corporation. Reproduction of any or all of the contents of this document without consent of the company is a violation of copyright law. However, one back-up copy may be made for non-commercial, personal purposes.

Also, the contents of this document are subject to change in the future without prior notice.

- Concerning Safety Warnings

Warnings concerning safety and use, and the contents of this document, conform to existing standards as of the date published.

- Concerning Modification

This printer was planned, developed, and manufactured by Mitsubishi Electric Corporation and for safety purposes, any modification of the device is prohibited.

Introduction

Thank you for purchasing this device.
 This document explains the handling and operation required to use this printer.
 Please read this document well before use.

■ About the symbols

The symbols shown have the following meanings:

 Caution	Accidents caused by failure to heed the warnings accompanying this symbol could lead to physical injury or property damage.
--	---

Cautions for Set-up

- Prior to operation, read “Safety Guide” carefully and observe the rules therein.
- Use care when moving the printer. Never try carrying the printer alone.
 Dropping it could cause injury or damage to other property.
- Do not use or store the printer near fire, excessive moisture, in direct sunlight, near an air conditioner or heater, or any other source of unusually high or low temperature or humidity, or excessive dust.
- Do not place the printer where chemical reactions occur, such as in a laboratory.
- Do not set up the printer where there is salinity or corrosive gas in the air.
- The printer must sit on a firm, level surface where there is ample ventilation.
- Do not put anything on the top of the printer.
- Do not place the printer near a radio or television, and do not use the same wall outlet for the printer and radio or television. Radio or television reception could be adversely affected.
- Do not use a power voltage or frequency other than those specified.
- Do not put anything on the power cord or step on it.
- Do not drag or carry the printer by the power cord or USB cable.
- Avoid plugging the power cord into an outlet with many loads.
- Do not bundle the power cord.
- Always grip the plug housing, not the cord, to plug/unplug the power cord.
- Make certain the power is turned off before connecting/disconnecting the USB cable.
- Avoid lengthening the signal cable or connecting it to any noise-producing device.
 If it is unavoidable, use a shielded cable or twisted pair for each signal.
- Place the printer near the outlet where the power cord can be unplugged easily to shut off power.
- Use an AC outlet that accepts a three-pronged plug. Otherwise, there may be danger of electric shock.
- Use the appropriate specified cord set.
 Only use items that are certified safe according to the standards of the country where they are to be used

•American, Canadian Users

Cord set No INQ.1417

	Parts number	Rating	Acquired Standard No
Plug	CAT-009	125V 13A	UL:E69228 CSA:LL93534
Cord	SJT	1.25mm ² 3G	UL:E69167 CSA:LL97391 LL92902 LL42379
Connector	EF-28	125V 13A	UL:E69228 CSA:LL93534

Cord set No 5-AB0638

	Parts number	Rating	Acquired Standard No
Plug	KP-30	125V 13A	UL: E118569 CSA: LR84390
Cord	SJT	1.25mm ² 3G	UL: E42955 CSA: LL84512
Connector	KS-32	125V 13A	UL: E118569 CSA: LL84391

•European Users

Cord set No 764S

	Parts number	Rating	Acquired Standard No
Plug	203	10/16A 250V	EN60799
Cord	H05VV-F	1.00mm ² 3G	EN60799
Connector	EF-28	250V 10A	EN60799

Cord set No 764S

	Parts number	Rating	Acquired Standard No
Plug	KP-4819Y	10 / 16A 250V	IEC60884
Cord	H05VV-F(GTCE-3)	1.00mm ² 3G	IEC60227-5
Connector	KS-31A	250V 10A	IEC60320-1

English

Hereby, Mitsubishi Electric Corporation declares that this CP3800DW is in compliance with the essential requirements and other relevant provisions of Directive 1999/5/EC.

Finnish

Mitsubishi Electric Corporation vakuuttaa täten että CP3800DW tyyppinen laite on direktiivin 1999/5/EY oleellisten vaatimusten ja sitä koskevien direktiivin muiden ehtojen mukainen.

Dutch

Hierbij verklaart Mitsubishi Electric Corporation dat het toestel CP3800DW in overeenstemming is met de essentiële eisen en de andere relevante bepalingen van richtlijn 1999/5/EG

Bij deze verklaart Mitsubishi Electric Corporation dat deze CP3800DW voldoet aan de essentiële eisen en aan de overige relevante bepalingen van Richtlijn 1999/5/EC.

French

Par la présente Mitsubishi Electric Corporation déclare que l'appareil CP3800DW est conforme aux exigences essentielles et aux autres dispositions pertinentes de la directive 1999/5/CE.

Par la présente, Mitsubishi Electric Corporation déclare que ce CP3800DW est conforme aux exigences essentielles et aux autres dispositions de la directive 1999/5/CE qui lui sont applicables.

Swedish

Härmed intygar Mitsubishi Electric Corporation att denna CP3800DW står i överensstämmelse med de väsentliga egenskapskrav och övriga relevanta bestämmelser som framgår av direktiv 1999/5/EG.

Danish

Undertegnede Mitsubishi Electric Corporation erklærer herved, at følgende udstyr CP3800DW overholder de væsentlige krav og øvrige relevante krav i direktiv 1999/5/EF

German

Hiermit erklärt Mitsubishi Electric Corporation dass sich dieser/diese/dieses CP3800DW in Übereinstimmung mit den grundlegenden Anforderungen und den anderen relevanten Vorschriften der Richtlinie 1999/5/EG befindet".(BMWi)

Hiermit erklärt Mitsubishi Electric Corporation die Übereinstimmung des Gerätes CP3800DW mit den grundlegenden Anforderungen und den anderen relevanten Festlegungen der Richtlinie 1999/5/EG.(Wien)

Greek

ΜΕ ΤΗΝ ΠΑΡΟΥΣΑ Mitsubishi Electric Corporation ΔΗΛΩΝΕΙ ΟΤΙ CP3800DW ΣΥΜΜΟΡΦΩΝΕΤΑΙ ΠΡΟΣ ΤΙΣ ΟΥΣΙΩΔΕΙΣ ΑΠΑΙΤΗΣΕΙΣ ΚΑΙ ΤΙΣ ΛΟΙΠΕΣ ΣΧΕΤΙΚΕΣ ΔΙΑΤΑΞΕΙΣ ΤΗΣ ΟΔΗΓΙΑΣ 1999/5/ΕΚ

Italian

Con la presente Mitsubishi Electric Corporation dichiara che questo CP3800DW è conforme ai requisiti essenziali ed alle altre disposizioni pertinenti stabilite dalla direttiva 1999/5/CE.

Spanish

Por medio de la presente Mitsubishi Electric Corporation declara que el CP3800DW cumple con los requisitos esenciales y cualesquiera otras disposiciones aplicables o exigibles de la Directiva 1999/5/CE.

Portuguese

Mitsubishi Electric Corporation declara que este CP3800DW está conforme com os requisitos essenciais e outras disposições da Directiva 1999/5/CE.

Malti

Hawnhekk, Mitsubishi Electric Corporation jiddikjara li dan CP3800DW jikkonforma mal-htigijiet essenzjali u ma provvedimenti oħrajn rilevanti li hemm fid-Dirrettiva 1999/5/EC

Table of Contents

<i>Introduction</i>	2
<i>Cautions for Set-up</i>	2
<i>Table of Contents</i>	6
Setting Up the Printer	7
<i>Checking the Contents</i>	7
<i>Names of Components</i>	8
<i>Connecting the Power Cord</i>	9
<i>Connecting to the Computer</i>	9
<i>Paper and Ribbon</i>	10
<i>Setting the Media</i>	11
Trouble-shooting	16
<i>Error Displays</i>	16
<i>Solving Media Errors</i>	17
Cleaning	21
<i>Platen Roller</i>	21
Specifications	22

Checking the Contents

Please check that the printer and all accessories are included in the package.

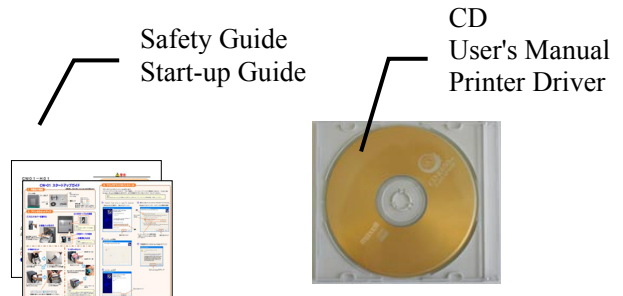
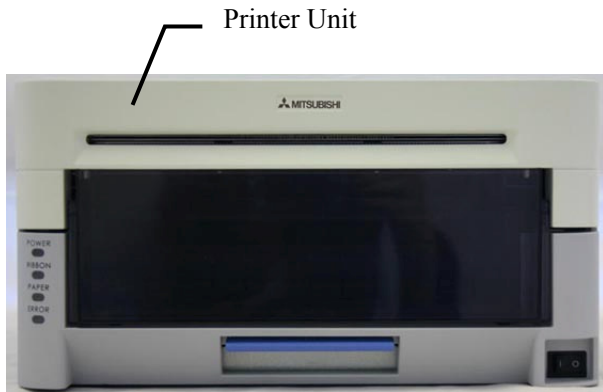

Paper Holder
(Set in the printer)
* Remove wrapping before use



Power Cord×2
Europe,US



Paper Cassette
(Set in the printer)



Ribbon Cassette
(Set in the printer)



CAUTION

- When removing the printer from its package, carrying it, or moving it, be sure to use care. Dropping the printer could result in personal injury or damage to other items.
- If the printer is lifted by grasping the cushions, the cushions could break and cause the printer to be dropped.

Names of Components

[Front of Unit]

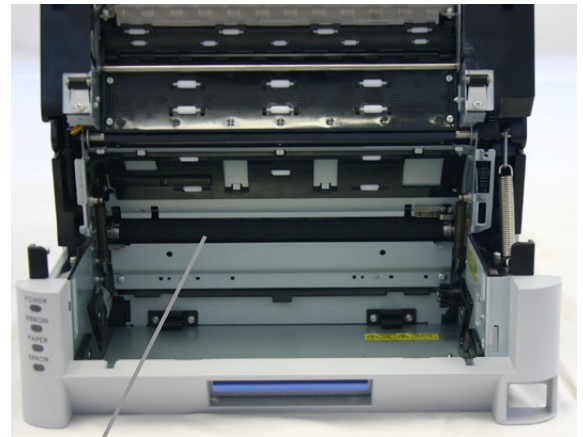
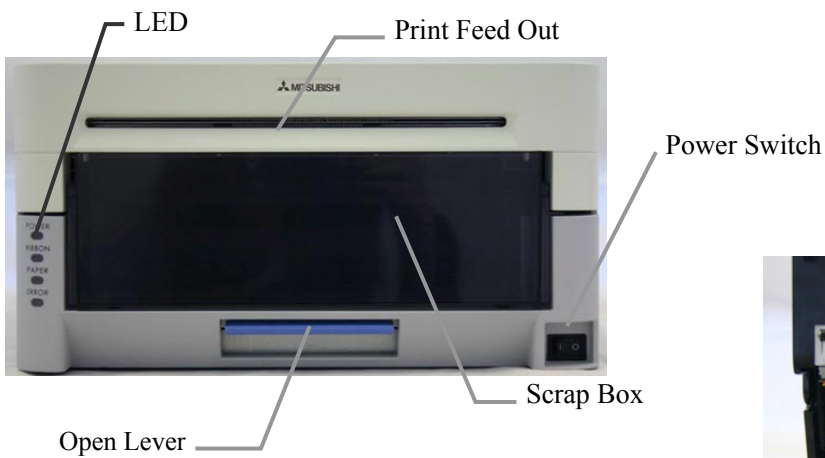

Platen Roller

[Back of Unit]

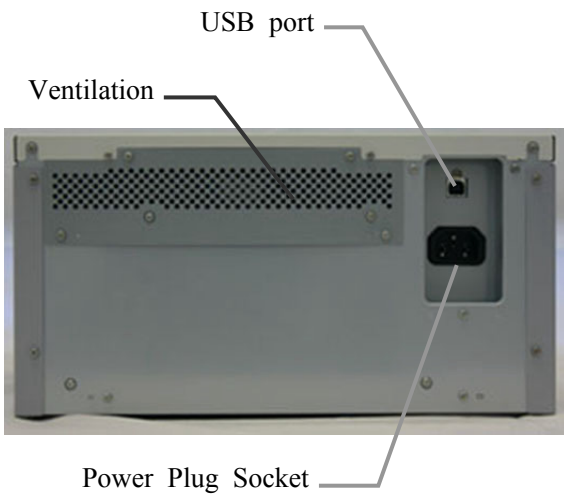

[Side of Unit]



Ventilation



CAUTION

- Please be careful not to hurt yourself or damage anything on the edges of the printer.

Connecting the Power Cord

1. Make sure that the printer's power switch is set to the OFF position.
2. Plug the cord connector end into the printer Power Plug Socket.
3. Plug the cord into the wall outlet.



Connecting to the Computer



1. Make sure that both the printer and computer power switches are set to the OFF position.
2. Connect the USB cable to the printer and the computer.
3. Turn on the power.



CAUTION

- Please use the power cable that came with the printer, and be sure to attach the ground wire.

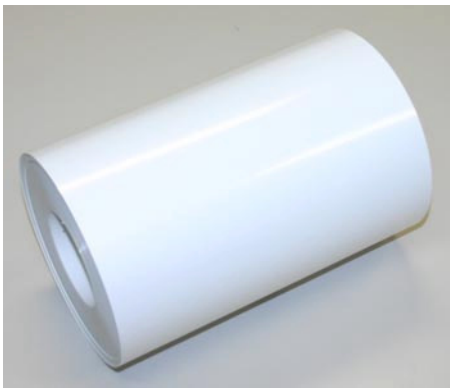
Paper and Ribbon

Type	8inch
Paper	
	Width: 203mm
Ribbon	
	Width: 210mm



CAUTION

- Set the paper and ribbon without putting them directly on the work surface. Any dust or dirt could get inside the printer and adversely affect the print quality.

Setting the Media

1. Release the Open Lever, and pull out the mechanism unit.



Open Lever

2. Open the Paper Release lever.

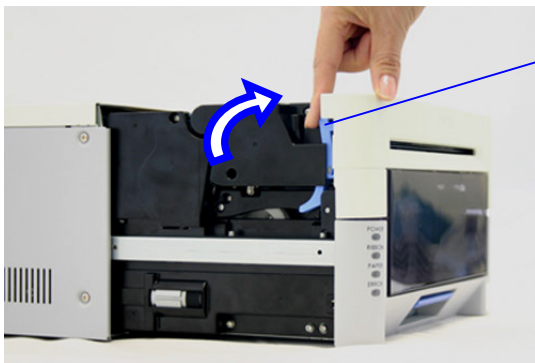

Paper Release Lever

3. Remove the scrap box

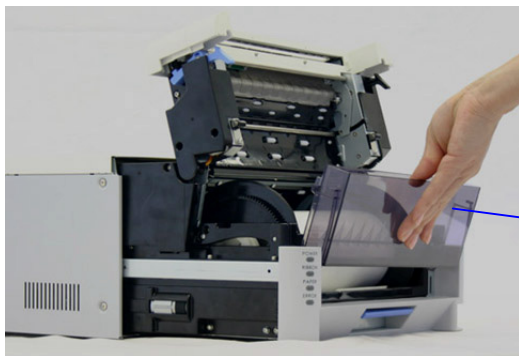

Scrap Box

4. Remove the entire paper cassette unit.

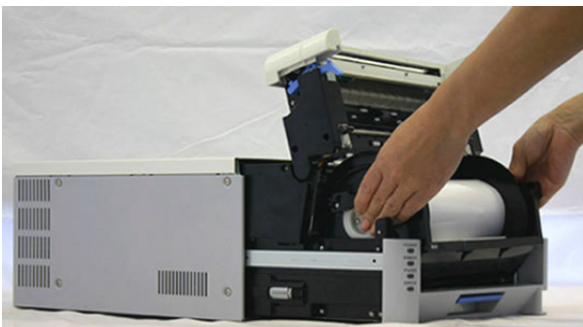

- Install the new roll of paper on the paper holder.
When installing it, make sure there are no gaps between the paper and the holder.
Make sure the paper is not sticking out. If the end of the roll is uneven (with paper sticking out), remove it from the holder, and flatten it.

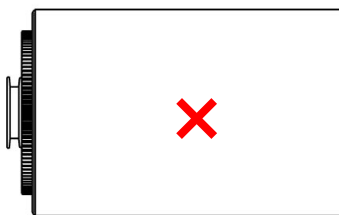
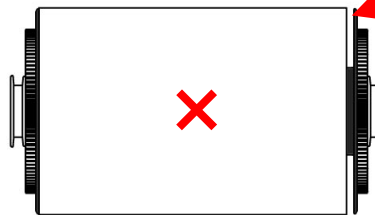
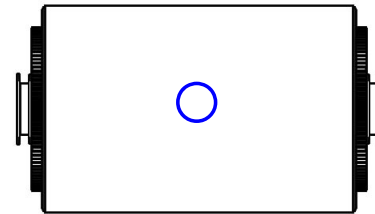

No gaps

Check for uneven ends

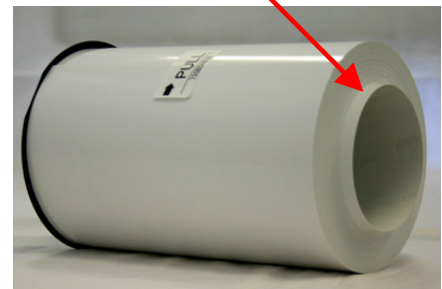

- Set the paper holder into the paper cassette. (Set it firmly all the way in)
Set the paper in the direction indicated below.

Paper direction

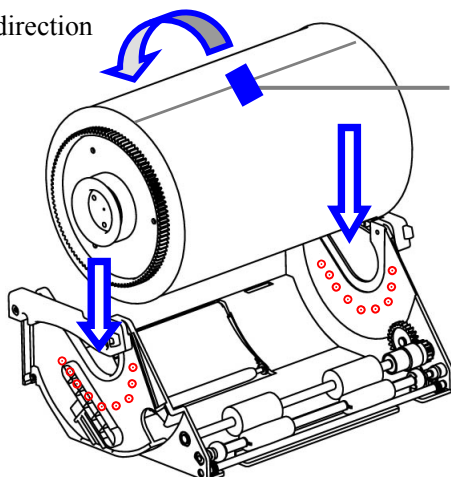

Seal

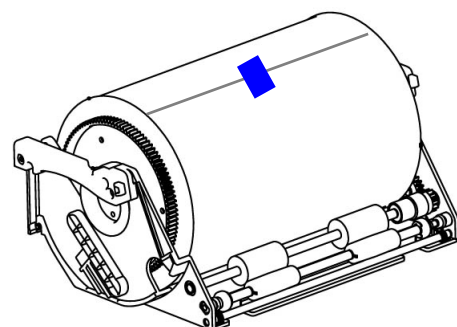

Setting Up the Printer

7. Remove the tape, and advance the roll as indicated by the arrow. Set the end of the paper about 5mm beyond the roller. When doing this, insert the paper straight along the seal. If it isn't inserted straight, the paper will be crooked, which could cause white line on the edges of the print, ribbon wrinkles, and register slippage.

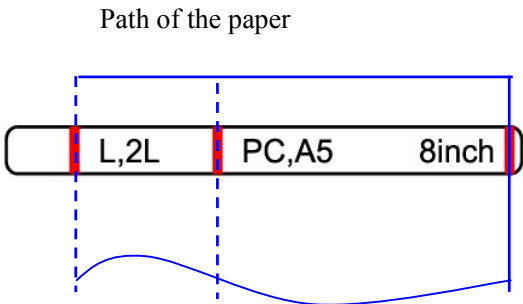
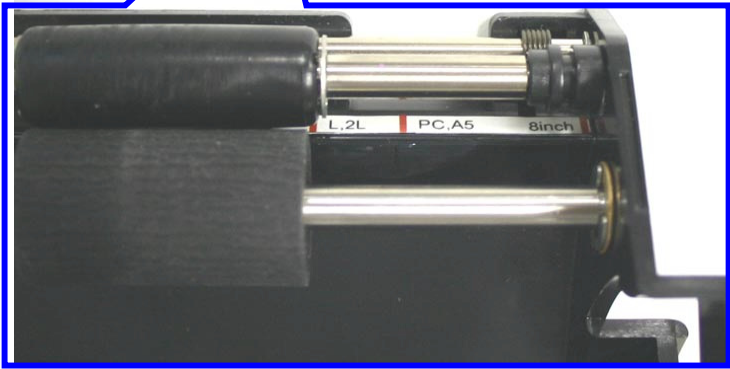
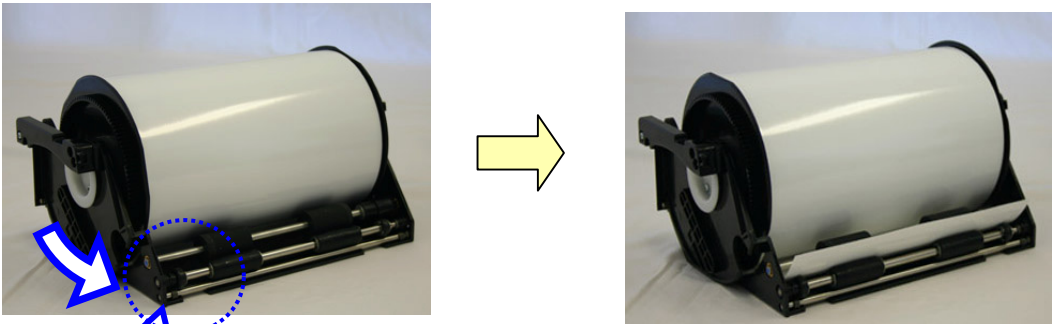

As seen from above

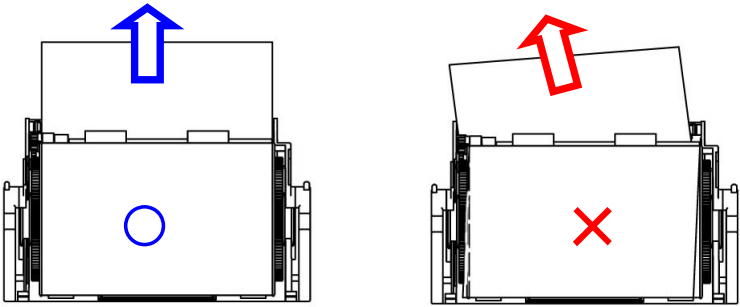

8. Set the paper cassette into the printer.

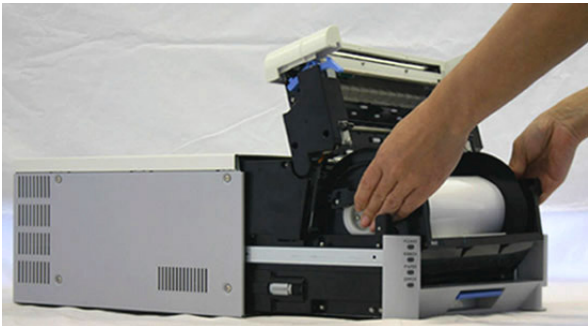

Setting Up the Printer

9. Turn the paper in the direction of the arrow. When it is advanced enough, the buzzer will beep, and the flashing LED (orange) will go out.
It is easier to set if the paper is turned while securing the holder with one hand.

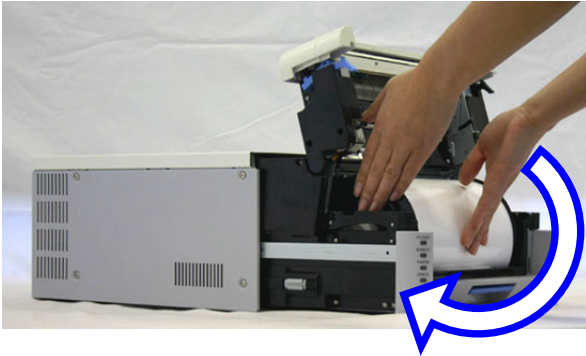

10. Set the scrap box, and close the cover.
The printer will not operate without the scrap box.
If the mechanism unit is closed without the scrap box attached, there will be a “No Scrap Box Error”, and the LED will flash (red).

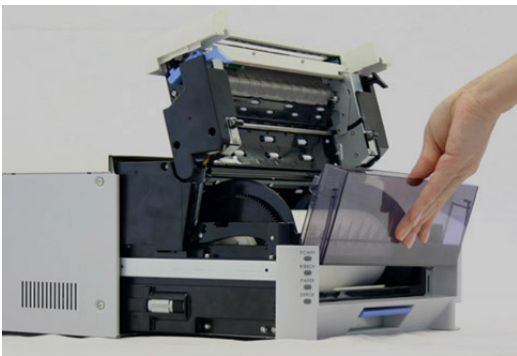

CAUTION

- The printer will not operate without the scrap box attached.
- When the scrap box is removed, do not insert your fingers in the cutter at the top. They could be cut or severed.
- As prints are cut, the scrap box fills with scrap paper. Be sure to empty it when you change the paper and ribbon. If it becomes over-filled with scraps, it could cause problems with the printer.

11. Set the new ribbon into the ribbon cassette.
Advance the ribbon in the direction of the arrow, and take up any slack.

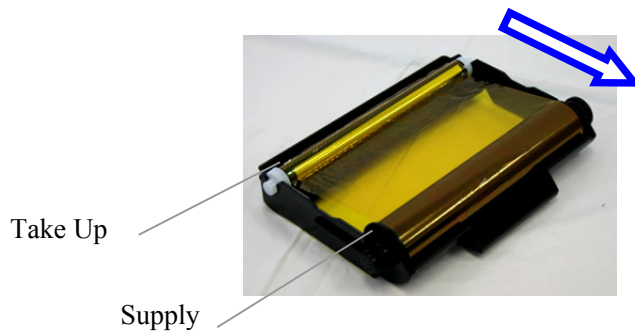

Set it with the supply side in front.

Set here

Supply side



13. Close the mechanism unit.

*When the mechanism unit is closed, the printer will run initialization (4 blank sheets will be fed out).
However, if the power is turned ON after the paper is set, it won't run the initialization.
By running initialization, the dirty outer layer of paper is cut off.



*In order to facilitate media color adjustment, media type recognition, and print quantity management, an IC chip is built into the ink ribbon. Media without an IC chip, which has not been evaluated and cleared, may not function properly. (If correct data cannot be read from the IC chip, an alarm will sound. In this case, in order to protect the printer, it will lower the concentration for printing.)

*Please change the media as a set, because the IC chip for each ribbon has unique information. Otherwise, errors could occur.



CAUTION

- Replace the ribbon and paper as a set to avoid problems later.

Error Displays



The flashing LED indicates the printer status

Status	LED display				Solution	Refer to
	Power	Ribbon	Paper	Error		
Paper End *1	●		★		Put in a new roll of paper	P.12
Ribbon End *1	●	★			Put in a new roll of ribbon	P.16
Door is Open (no paper)	●		★	★	Set the paper properly and close the mechanism unit	P.12
Door is Open	●			★	Close the mechanism unit	P.16
No Scrap Box	●			★	Set the scrap box	P.15
Paper Error	●		●	●	Free the paper, and reset it correctly	P.18
Ribbon Error	●	●		●	Fix the ribbon, and set it correctly	P.20
System Error *2	●			●	Re-boot the printer (turn off, then on)	-
Head Cool Down	★				The head is cooling off (auto-recovery)	-

*● indicates lit, ★ indicates flashing, and blank is not lit

*1 Exchange the paper and ribbon as a set.

*2 If the system error cannot be corrected, contact the dealer.

Solving Media Errors

1. Pull out the mechanism unit.



2. Remove the ribbon cassette.



- a. If the paper is jammed:



1. Pull any paper remaining in the printer in the direction shown, and cut off any wrinkled or partially printed areas evenly with scissors.
 Printing over an already printed area will cause the ribbon to stick, and the paper will jam again.
 When pulling the paper out, pull it slowly. Application of too much force could damage the printer.



CAUTION

- Please be careful not to hurt yourself or damage anything on the edges of the printer.

2. Remove the scrap box, and rewind the paper.

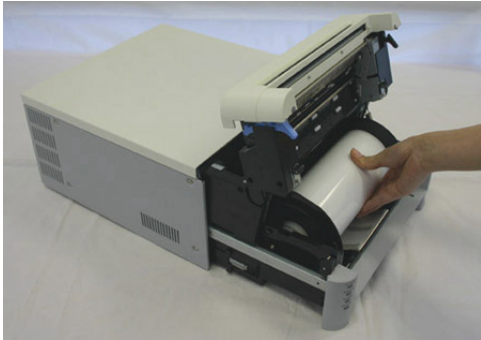

3. Cut off any partially printed, wrinkled, or otherwise inferior paper evenly with a pair of scissors, and reset the paper. If wrinkles or partially printed areas are left, it could cause the paper to jam again.



Cutting the paper

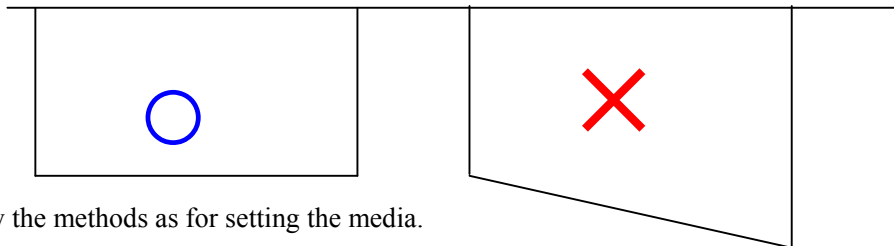

Then follow the methods as for setting the media.

b. If the ribbon is pulled into the mechanism:

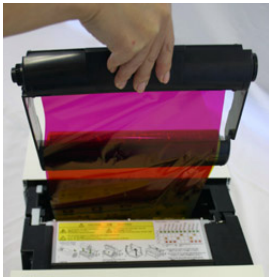

1. Cut the ribbon.



2. Carefully remove any ribbon remaining in the mechanism.
Any pieces of ribbon left inside the mechanism could affect print quality.
In this case, clean the platen roller see P.22



3. Reattach the ribbon with cellophane (or similar) tape.



Tape

4. Rotate the up-take ribbon several times until the tape is out of sight. Take care that there is no slack in the ribbon.



Then, refer to a. If the paper is jammed.

c. If the printer is stopped in the middle of cutting:



1. Turn the power back ON. Free the jammed paper, and return the cutter blade to its ready position.

If the jammed paper cannot be freed, please contact a service representative.

2. Remove any partially printed material from inside the mechanism unit.
Then, refer to a. If the paper is jammed.

d. If power is cut during printing:

*If the power is cut during printing, you will not be able to pull out the mechanism unit.

1. Turn the power back ON. The partial print will be cut into scrap-size pieces and removed.
After this, you will be able to pull out the mechanism unit.
2. Check that there is no printed material in the mechanism unit.
If the paper is jammed, refer to a. If the paper is jammed.



CAUTION

- Do not turn the power OFF while printing. This could damage the printer.

Platen Roller

If there is an indent on the pictures at a regular interval, or if the back of the picture (white side) is dirty, clean the platen roller.

There may be dust, grime, adhesives, etc. from the ribbon or paper on the platen roller.

1. Prepare a piece of gauze or other soft cloth soaked in ethyl alcohol.
Benzenes or thinners other than ethyl alcohol may permeate the resin, so they should not be used.
2. Wipe off any grime while turning the platen roller.



CAUTION

- Please be careful not to hurt yourself or damage anything on the edges of the printer.
- Never use benzenes or thinners other than ethyl alcohol, as they may permeate the resin.

Model		CP3800DW	
Print type		Thermal dye sublimation transfer	
Print mode		High-speed mode	High quality mode
Resolution		300×300dpi	300×600dpi
Print size	8×4	203×102mm	
	8×5	203×127mm	
	8×6	203×152mm	
	8×8	203×203mm	
	8×10	203×254mm	
	A4	203×297mm	
	8×12	203×305mm	
Print sheet	8×10	130 sheets	
	8×12	110 sheets	
Print time	8×10	Approx. 30 sec	Approx. 40 sec
	A4	Approx. 34 sec	Approx. 45 sec
	8×12	Approx. 35 sec	Approx. 46 sec
Ribbon type		YMC+overcoat	
Interface		USB2.0	
Driver-compatible OS		Windows 2000/XP	
Dimensions		322mm W ×366mm D × 170mm H	
Weight		Approx. 14kg(printer only)	
Power		AC100V-240V 50/60Hz	
Power consumption		120V 4.0A 240V 1.7A	
Noise		A-weighted sound pressure level < 70dB: " less than 70 dB"	
Operating Environment	Temp. 5 – 35 degrees C in natural conditions		
	Humidity 35 – 80% with no condensation		

*These specifications may be changed without prior notice.

Information on servicing the printer

For questions regarding operation and servicing of the printer, contact the dealer where the printer was purchased, or consult at the following:

MITSUBISHI DIGITAL ELECTRONICS AMERICA, INC.

9351 Jeronimo Road, Irvine, CA 92618, U.S.A.
Phone 949-465-6000

Mitsubishi Electric Europe B.V.

UK Branch

Travellers Lane, Hatfield, Herts. AL10 8XB, England, U.K.
Phone +44 (0) 1707 276100 FAX +44 (0) 1707 278755

German Branch

Gothaer Strasse 8, 40880 Ratingen ; Postfach 1548, 40835 Ratingen ; Germany
Phone +49 (2102) 486-9250 FAX +49 (2102) 486-7320

French Branch

25, Boulevard des Bouvets - 92741 NANTERRE cedex, France
Phone +33 (1) 55 68 55 00 FAX +33 (1) 55 68 57 31

Italian Branch

Centro Direzionale Colleoni, Palazzo Sirio, ingresso n.1
Viale Colleoni, 7, 20041 Agrate Brianza, (Milano) Italy
Phone +39 03960531 FAX +39 0396053214

Benelux Branch

Nijverheidsweg 23a,
3641 RP Mijdrecht, The Netherlands
Phone +31 (0) 297-282461 FAX +31 (0) 297-283936

Spanish Branch (Barcelona)

Ctra. de Rubi, 76-80 - Apdo. 420
08190-Sant Cugat del Valles - (Barcelona) Spain
Phone +34 93 565 3154 FAX +34 93 589 4388

Please contact the nearest Mitsubishi sales branch to get DOC (Declaration of Conformity) of the EC Directive 1999/5/EC.